

MGate 5123 Series User Manual

Version 1.1, January 2025

www.moxa.com/products

MOXA®

© 2025 Moxa Inc. All rights reserved.

MGate 5123 Series User Manual

The software described in this manual is furnished under a license agreement and may be used only in accordance with the terms of that agreement.

Copyright Notice

© 2025 Moxa Inc. All rights reserved.

Trademarks

The MOXA logo is a registered trademark of Moxa Inc.
All other trademarks or registered marks in this manual belong to their respective manufacturers.

Disclaimer

- Information in this document is subject to change without notice and does not represent a commitment on the part of Moxa.
- Moxa provides this document as is, without warranty of any kind, either expressed or implied, including, but not limited to, its particular purpose. Moxa reserves the right to make improvements and/or changes to this manual, or to the products and/or the programs described in this manual, at any time.
- Information provided in this manual is intended to be accurate and reliable. However, Moxa assumes no responsibility for its use, or for any infringements on the rights of third parties that may result from its use.
- This product might include unintentional technical or typographical errors. Changes are periodically made to the information herein to correct such errors, and these changes are incorporated into new editions of the publication.

Technical Support Contact Information

www.moxa.com/support

Table of Contents

1. Introduction	4
2. Getting Started	5
Connecting the Power	5
Connecting CAN Devices	5
Connecting to a Network	5
Installing DSU Software	5
Log In to the Web Console	6
microSD	6
3. Web Console Configuration and Troubleshooting	8
System Dashboard	8
System Settings	9
System Settings—General Settings	9
System Settings—Network Settings	11
System Settings—SNMP Settings	13
Protocol Settings	17
Protocol Settings—Protocol Conversion	17
Protocol Settings—CANopen Master Settings	18
Protocol Settings—J1939 Settings	25
Protocol Settings—CAN Proprietary Settings	28
Protocol Settings—PROFINET IO Device Settings	38
Protocol Settings—SNMP Mapping Settings	40
Diagnostics	41
Diagnostics—Protocol Diagnostics	41
Diagnostics—Protocol Traffic	45
Diagnostics—Event Log	46
Diagnostics—Tag View	51
Diagnostics—Network Connections	52
Diagnostics—Ping	52
Diagnostics—LLDP	52
Security	53
Security—Account Management	53
Security—Service	57
Security—Allow List	58
Security—DoS Defense	58
Security—Login Policy	59
Security—Certificate Management	60
Maintenance	61
Maintenance—Configuration Import/Export	61
Maintenance—Firmware Upgrade	62
Maintenance—Load Factory Default	62
Restart	63
Status Monitoring	63
4. Network Management Tool (MXstudio)	65
A. SNMP Agents with MIB II	66
RFC1213 MIB-II Supported SNMP Variables	66

1. Introduction

The MGate 5123 is an industrial Ethernet gateway for converting CANopen, J1939 or CAN proprietary (CAN 2.0A/B) to PROFINET and SNMP network communications. To integrate existing CAN-based devices into a PROFINET or SNMP network, use the MGate 5123 as a CAN master to collect data and exchange data with the PROFINET host or SNMP client. All models are protected by rugged and compact metal housing and are DIN-rail mountable. The rugged design is suitable for industrial applications such as factory automation and other process automation industries.



NOTE

CAN proprietary (CAN 2.0 A/B) is supported in firmware version V2.0 and later.

2. Getting Started

Connecting the Power

Power the unit by connecting a power source to the terminal block.

1. Connect the 12 to 48 VDC power line or DIN-rail power supply to the MGate's power terminal block.
2. Tighten the screws on both sides of the terminal block.
3. Turn on the power source.

Note that the unit does not have an on/off switch. It automatically turns on when it receives power. The PWR LED on the top panel will glow to show that the unit is receiving power. For power terminal block pin assignments, refer to the *Quick Installation Guide*, **Power Input and Relay Output Pinout** section.

Connecting CAN Devices

The MGate supports CAN devices. Always turn off the power before connecting or disconnecting the serial connection. For the CAN port pin assignments, refer to the *Quick Installation Guide*, **Pin Assignments** section.

Connecting to a Network

Connect one end of the Ethernet cable to the MGate's 10/100M Ethernet port and the other end of the cable to the Ethernet network. The MGate will show a valid connection to the Ethernet in the following ways:

- The Ethernet LED maintains a solid green color when connected to a 100 Mbps Ethernet network.
- The Ethernet LED maintains a solid orange color when connected to a 10 Mbps Ethernet network.
- The Ethernet LED will flash when Ethernet packets are being transmitted or received.

Installing DSU Software

If you do not know the MGate gateway's IP address when setting it up for the first time (default IP is *192.168.127.254*); use an Ethernet cable to connect the host PC and the MGate gateway directly. If you connect the gateway and host PC through the same Ethernet switch, make sure there is no router between them. You can then use the **Device Search Utility (DSU)** to detect the MGate gateways on your network. Download DSU (Device Search Utility) from Moxa's website: www.moxa.com.

The following instructions explain how to install the DSU, a utility to search for MGate units on a network.

1. Locate and run the following setup program to begin the installation process:
dsu_setup_[Version]_Build_[DateTime].exe
This version might be named **dsu_setup_Ver2.x_Build_xxxxxxx.exe**
2. The Welcome window will greet you. Click **Next** to continue.
3. When the **Select Destination Location** window appears, click **Next** to continue. You may change the destination directory by first clicking on **Browse...**
4. When the **Select Additional Tasks** window appears, click **Next** to continue. You may select **Create a desktop icon** if you would like a shortcut to the DSU on your desktop.
5. Click **Install** to copy the software files.
6. A progress bar will appear. The procedure should take only a few seconds to complete.
7. A message will show that the DSU is successfully installed. You may choose to run it immediately by selecting **Launch DSU**.
8. You may also open the DSU through **Start > Programs > MOXA > DSU**.

The DSU window will appear as shown below. Click **Search** and a new Search window will pop up.

No	Model	LAN1 MAC Address	LAN1 IP Address	LAN2 MAC Address	LAN2 IP Address	Status	Firmware Version
1	MGate 5123-T	00:90:E8:B8:56:B0	192.168.127.254	...			*****

Log In to the Web Console

Use the Web console to configure the MGate through Ethernet or verify the MGate's status. Use a web browser, such as Google Chrome to connect to the MGate, using the HTTPS protocol.

When the MGate gateway appears on the DSU device list, select the gateway and right-click the mouse button to open a web console to configure the gateway.

On the login page, create an account name and set a password that is at least eight characters long when you log in for the first time. Or if you have already an account, log in with your account name and password. If you change the MGate's IP and other related network settings, click **SAVE**, and the MGate will reboot.

MOXA®

Log in to
MGate 5123-T_1040798

Account Name

Password

LOG IN

microSD

The MGate provides users with an easy way to back up, copy, replace, or deploy. The MGate includes a microSD card slot. Plug in a microSD card to back up data, including the system configuration settings.

First time use of a new microSD card with the MGate gateway

1. Format the microSD card as FAT file system through a PC.
2. Power off the MGate and insert the microSD card (ensure that the microSD card is empty).
3. Power on the MGate. The default settings will be copied to the microSD card.
4. Manually configure the MGate via the web console, and all the stored changes will copy to the microSD card for synchronization.

First time use of a microSD card containing a configuration file with the MGate gateway

1. Power off the MGate and insert the microSD card.
2. Power on the MGate.
3. The configuration file stored in the microSD card will automatically copy to the MGate.

Duplicating current configurations to another MGate gateway

1. Power off the MGate and insert a new microSD card.
2. Power on the MGate.
3. The configuration will be copied from the MGate to the microSD card.
4. Power off the MGate and insert the microSD card to the other MGate.
5. Power on the second MGate.
6. The configuration file stored in the microSD card will automatically copy to the MGate.

Malfunctioning MGate replacement

1. Replace the malfunctioning MGate with a new MGate.
2. Insert the microSD card into the new MGate.
3. Power on the MGate.
4. The configuration file stored on the microSD card will automatically copy to the MGate.

microSD card writing failure

The following circumstances may cause the microSD card to experience a writing failure:

1. The microSD card has less than 256 Mbytes of free space remaining.
2. The microSD card is write-protected.
3. The file system is corrupted.
4. The microSD card is damaged.

In case of the above events, the MGate will flash Ready LED in red. When you replace the MGate gateway's microSD card, the microSD card will synchronize the configurations stored on the MGate gateway. Note that the replacement microSD card should not contain any configuration files on it; otherwise, the out-of-date configuration will be copied to the MGate device.

3. Web Console Configuration and Troubleshooting

This chapter provides a quick overview of how to configure the MGate 5123 by web console.

System Dashboard

This page gives a system dashboard of the MGate 5123 gateway.

The screenshot shows the MGate 5123 System Dashboard. The interface includes a sidebar with navigation options like System Dashboard, General Settings, Network Settings, and Diagnostic. The main content area is divided into several sections: System Information (showing model name, serial number, firmware version, uptime, IP, MAC, and MicroSD status), Panel Status (with System LED and Port LED indicators for PWR1, PWR2, READY, ETH1, ETH2, PN, and CAN), Event Summary (a table of alerts, warnings, and info events), and Relay State (a table of relay events with acknowledge buttons).

ID	Severity	Message	Timestamp
1	Alert	Power input 1 failure	2023-05-29T16:45:59.590+00:00
2	Alert	Ethernet port 2 link down	2023-05-29T16:45:59.578+00:00
3	Alert	Ethernet port 1 link down	2023-05-29T16:45:59.576+00:00
4	Alert	Ethernet port 1 link down	2023-05-16T14:38:20.741+00:00
5	Alert	Ethernet port 2 link down	2023-05-16T14:37:12.069+00:00

Change your password or log out using the options on the top-right corner of the page.

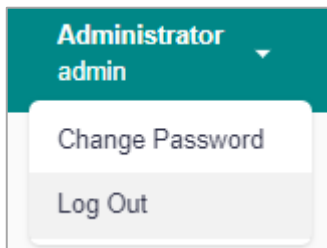

System Settings

System Settings—General Settings

On this page, change the name of the device and time settings.

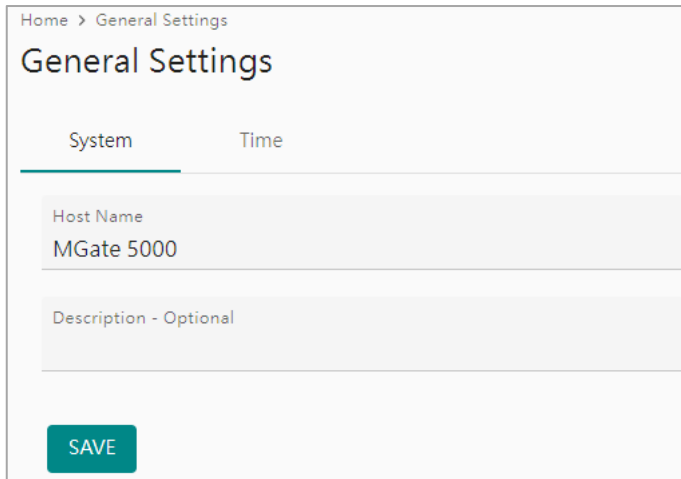

Home > General Settings

General Settings

System Time

Host Name
MGate 5000

Description - Optional

SAVE

System Settings

Parameter	Value	Description
Host Name	Alphanumeric string	Enter a name that helps you uniquely identify the device. For example, you can include the name and function of the device.
Description	Alphanumeric string	(optional) You can include additional description about the device such as function and location.

Time Settings

The MGate has a built-in real-time clock for time-calibration functions. Functions such as logs use the real-time clock to add the timestamp to messages.



ATTENTION

First-time users should select the time zone first. The console will display the actual time in your time zone relative to the GMT. If you would like to change the real-time clock, select Local time. The MGate's firmware will change the GMT time according to the Time Zone setting.

General Setting

Home > General Setting

System Time

Current date and time: July 4, 2022 at 18:29:23

Timezone
(GMT+08:00)Taipei

Daylight saving time
 Enable Disabled

Start
 Month: 3, Week: 5, Day: 0, Hour: 1

End
 Month: 10, Week: 5, Day: 0, Hour: 1

Offset
 +00:00

Sync Mode
 Manual Auto

[sync with browser](#)

Date
 2022/07/04

Hour: 18, Minute: 28, Second: 19

SAVE

Parameter	Value	Description
Time zone	User-selectable time zone	Shows the current time zone selected and allows change to a different time zone.
Daylight saving time	Enable/Disable	Set the daylight saving time.
Sync Mode	Manual	Use this setting to manually adjust the time (1900/1/1-2037/12/31) or sync with the browser time
	Auto	Specify the IP or domain of the time server to sync with (E.g., 192.168.1.1 or time.stdtime.gov.tw). This optional field specifies the IP address or domain name of the time server on your network. The module supports SNTP (RFC-1769) for automatic time calibration. The MGate will request the time information from the specified time server per the configured time period.



ATTENTION

If the dispersion of the time server is higher than the client (MGate), the client will not accept NTP messages from the time server. The MGate's dispersion is 1 second. You must configure your time server with a dispersion value lower than 1 sec for the NTP process to complete.

System Settings—Network Settings

Change the IP Configuration, IP Address, Netmask, Default Gateway, and DNS settings on the **Network Settings** page.

Network Setting

Home > Network Setting

LAN Mode
Switch ▼

LAN 1 IP Configuration

DHCP Static

IP Address
10.123.4.44

Netmask
255.255.255.0

Gateway
10.123.4.1

DNS Server

Preferred DNS Server
10.168.1.23

Alternative DNS Server
10.168.1.24

SAVE

Parameter	Value	Description
LAN Mode	Switch, Dual IP, Redundant LAN	<p>The Switch mode allows users to install the device with daisy-chain topology.</p> <p>The Dual IP mode allows the gateway to have two different IP addresses, each with distinct netmask and gateway settings. The IP addresses can have the same MAC address.</p> <p>NOTE: In the Dual IP mode, the PROFINET protocol can only be used on the LAN1 port (ETH1).</p> <p>The Redundant LAN mode allows users to use the same IP address on both Ethernet ports. The default active LAN port is ETH1 after bootup. If the active LAN fails to respond, the device will automatically switch to the backup LAN ETH2.</p>
IP Configuration	DHCP, Static IP	Select Static IP if you are using a fixed IP address. Select the DHCP option if you want the IP address to be dynamically assigned.
IP Address	192.168.127.254 (or other 32-bit number)	The IP Address identifies the server on the TCP/IP network.
Netmask	255.255.255.0 (or other 32-bit number)	Identifies the server as belonging to a Class A, B, or C network.
Gateway	0.0.0.0 (or other 32-bit number)	The IP address of the router that provides network access outside the server's LAN.
Preferred DNS Server	0.0.0.0 (or other 32-bit number)	The IP address of the primary domain name server.
Alternative DNS Server	0.0.0.0 (or other 32-bit number)	The IP address of the secondary domain name server.

System Settings—SNMP Settings

System Settings—SNMP Settings—SNMP Agent

SNMP Agent

Home > SNMP Agent

General SNMPv3 Account SNMPv3 Account Protection

Status

Enable Disabled

Note: enable/disable this service through [Service Enablement](#)

Version

v1 v2c v3

Contact

Location

Read Only Community

Read/Write Community

SAVE

Parameters	Description
Version	The SNMP version; the MGate supports SNMP v1, v2c, and v3.
Contact	The optional contact information; it usually includes an emergency contact name and telephone number.
Location	The location information. This string is usually set to the street address where the MGate is physically located.
Read-only Community	A text password mechanism that is used to weakly authenticate queries to agents of managed network devices. Default is empty. Type in the community string when selecting v1 v2c or v1 v2c v3 version.
Read/Write Community	A text password mechanism that is used to weakly authenticate changes to agents of managed network devices. Default is empty. Type in the community string when selecting v1 v2c or v1 v2c v3 version.
Minimum Authentication/Privacy Password Length	Minimum Authentication/Privacy Password Length must be between 8 and 64.

Read-only and Read/write Access Control

Define usernames, passwords, and authentication parameters in SNMP for two levels of access control: read-only and read/write. The access level is stated in the value of the Authority field. For example, Read-only authentication mode allows you to configure the authentication mode for read-only access, whereas Read/Write authentication mode allows you to configure the authentication mode for read/write access. For each level of access, configure:

Parameters	Value	Description
Account Name		The username for which the access level is being defined.
Authority	Read Only Read/Write	The level of access allowed
Authentication Type	Disable MD5 SHA1 SHA-224 SHA-256 SHA-384 SHA-512	Use this field to select MD5 or SHA as the method of password encryption for the specified level of access, or to disable authentication.
Privacy Type	Disable (Default) DES-CBC AES-128	Use this field to enable or disable data encryption for the specified level of access. If you enable a privacy type, also configure the privacy password.

If you need to change the SNMP Account settings created previously, click on the button on the right of the configured SNMP item to change settings, such as Authentication Type or Privacy Type.

Edit SNMPv3 Account

Account Name
Tiffany

Authority
Read/Write

Authentication Type
SHA-512

Authentication Password
.....

Privacy Type
AES-128

Privacy Password
.....

CANCEL SAVE

Home > SNMP Agent

SNMP Agent

General SNMPv3 Account **SNMPv3 Account Protection**

Disable SNMPv3 account if authentication failed

Max. Authentication Failures
5

Enable timeout for authentication failure

Each Authentication Failure Timeout (min)
10

Account Disabled Time Interval (min)
10

SAVE

Parameters	Value	Description
Max Authentication Failures	1 to 10 (default 5)	Specifies the maximum number for authentication failures. The MGate disables SNMPv3 when this number is exceeded.
Each Authentication Failure Timeout (min)	1 to 1440 (default 10)	Specifies a timeout period when enabling the Timeout for authentication failure function
Account Disabled Time Interval (min)	1 to 60 (default 10)	When the number of authentication failures exceeds the value set in Max. Authentication Failure Times , the MGate will disable the SNMPv3 for Account Disabled Time Interval.

System Settings—SNMP Settings—SNMP Trap

SNMP Trap

Home > SNMP Trap

General SNMP Trap Server

Trap Service

Active Inactive

SAVE

Set up the SNMP trap server to send the trap events, such as warning messages.

SNMP Trap

Home > SNMP Trap

General SNMP Trap Server

+ CREATE
maximum number of trap server is 2

Server IP	Port	Trap Version	Community	Account Name	Authentication Type	Privacy Type	
192.168.3.4	4442	Disable	-	-	-	-	

Create Trap Server

General Setting

Server IP

Port

Trap Method

Trap Version
Disable ▼

CANCEL **SAVE**

Parameters	Description
Server IP	SNMP server IP address or domain name.
Port	SNMP server IP Port.
Trap Version	Disable SNMPv1 SNMPv2c SNMPv3

Protocol Settings

Protocol Settings—Protocol Conversion

Select CANopen, J1939, or CAN proprietary on this page.

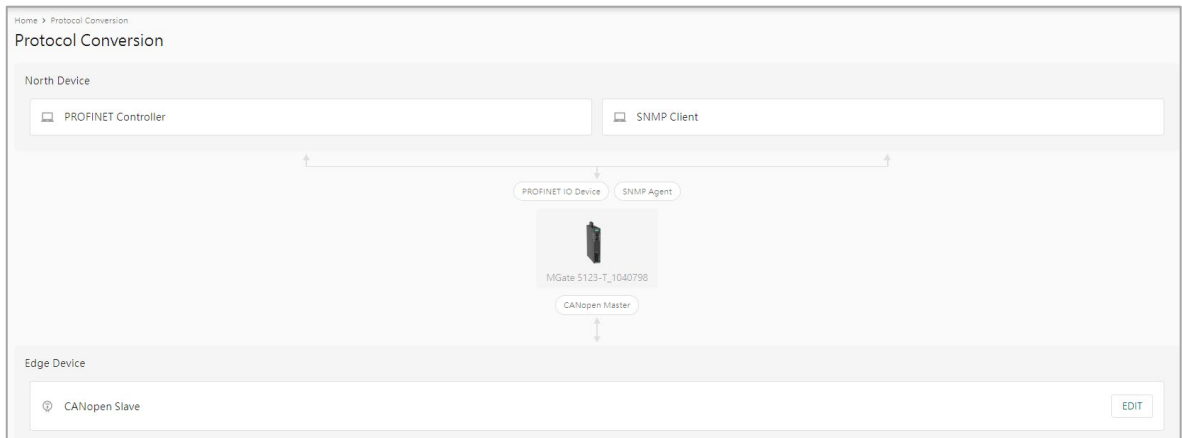

Click **Edit** at the "Edge Device" right-hand side and select your device protocol roles.

Click **SAVE** then **APPLY** on the warning pop-up window.

Protocol Settings—CANopen Master Settings

Manage CANopen devices on this page.

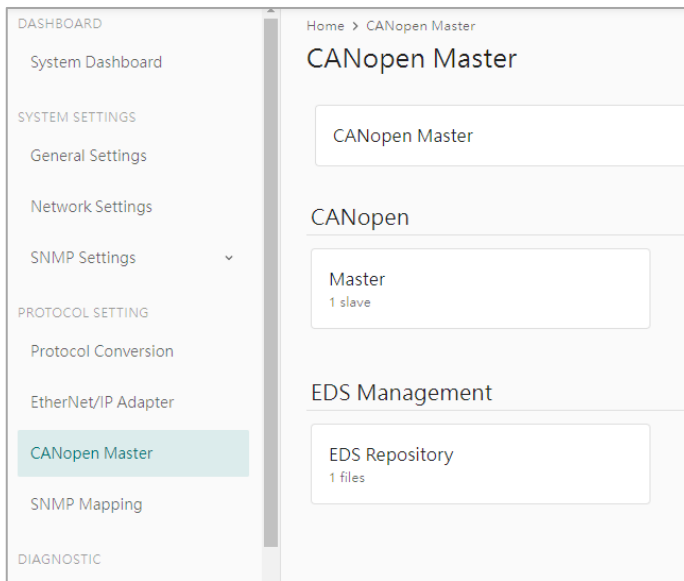

Manage CANopen slave device EDS files in "EDS Management-EDS Repository". The MGate stores up to 64 different EDS files. Click Import to add the EDS file. Tick the item and then you can delete it.

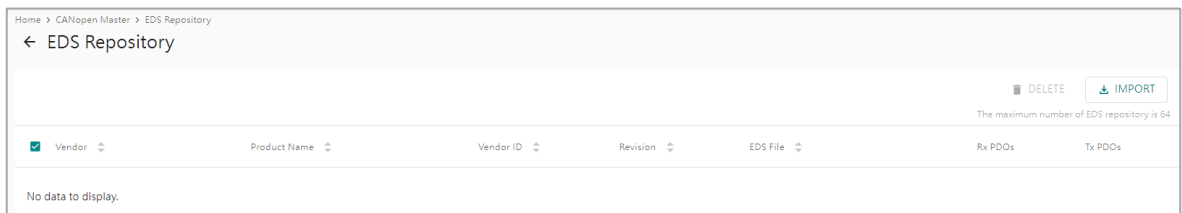

Parameter	Description
Vendor	Vendor name
Product Name	Product name
Vendor ID	Vendor ID registered in CiA organization
Revision	EDS file revision
EDS file	EDS file name
RxPDOs	Supports number of RxPDO
TxPDOs	Supports number of TxPDO

Click CANopen-Master to configure CANopen master and slave settings.

Master Settings

Parameter	Value	Default	Description
Node ID	1~127	1	Master CANopen Node ID
Baudrate	10 kbit/s 20 kbit/s 50 kbit/s 125 kbit/s 250 kbit/s 500 kbit/s 800 kbit/s 1 Mbit/s	125 kbit/s	Set CANopen network baudrate
Initial Delay (ms)	0 to 120000	0	For those CAN devices that need longer time to boot up, the MGate needs to wait until the device is ready for communication. Set the initial delay time to wait for the device to boot up.
CAN Bus-OFF Reset	Disable Enable	Disable	When the MGate detects the error count exceed the CAN threshold, the CAN bus will switch to Bus Off mode according to the CAN definition. Enable will auto reset the error count and restart the bus. Disable will stay in the Bus Off mode and only can recover by re-power the MGate.
CANbus Termination Resistor 120 ohms	Disable Enable	Disable	
SYNC- SYNC Producer	Disable Enable	Enable	Enable the MGate to send out the SYNC signal based on the interval time.
SYNC-Counter	Disable Enable	Enable	Enable to include SYNC counter information in the SYNC message. Counter is a 2 bytes value from 0~65535 with rolling over behavior.
SYNC-COB ID	0x0000 to 0xFFFF	0x0080	Standard SYNC COB ID is 0x0080
SYNC-Interval(ms)	0 to 65535	1000	Interval time for the SYNC message.
Time-Time Producer	Disable Enable	Enable	Enable the MGate to send out the TIME stamp message. TIME is a 6 bytes value with UAT format.
Time-COB ID	0x0000 to 0xFFFF	0x0100	Standard TIME COB ID is 0x0100
Time-Interval (ms)	0 to 65535	1000	Interval time for the TIME message.

The MGate CANopen master supports up to 256 TPDO and up to 256 RPDO. Click ADD to edit PDO with slave PDO COB ID. For example, if you want to mapping slave ID 2's RPDO4 to MGate TPDO1, please type in COB ID 0x0502 in the CANopen master TPDO1. If you want to mapping slave ID2's TPDO1 to CANopen master RPDO2, please type in COB ID 0x0182 in RPDO2.

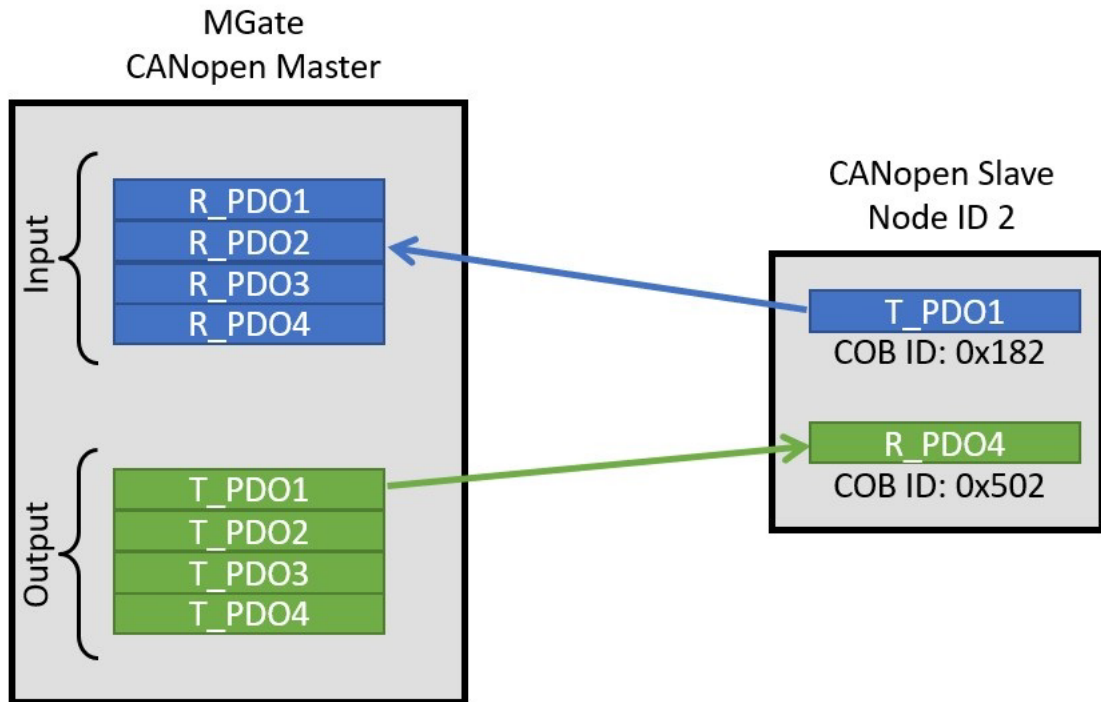

Add PDO

Master PDO
TPDO1

TPDO1

Enable

Slave Node ID
6

Slave PDO
RPDO1

COB ID
0x 0206

Transmission Type
Sync

No. of SYNCs
1

Fault Protection
Proceed - Set to User-Defined Value

Fault Timeout(ms)
60000

Info
The maximum length of the User-defined Value depends on the length specified in the Data Mapping configuration.

User-defined Value (Hex)
0 1 2 3 4 5 6 7 8 9

CANCEL SAVE

Bit Position	Object Index	Data Type	Tag Name	Endian	
0	0x6040 / 0x00	2 Byte	controlword	None	
16	0x607A / 0x00	4 Byte	target_positior	None	
48	Custom Object	1 Byte	tag	None	

Parameter	Value	Default	Description
PDO	TPDOx RPDOx		Max 256 TPDO, 256 RPTO
Enable	Disable Enable	Enable	
COB ID	0x0000 to 0xFFFF	0x0000	There are two methods to create COB ID. Automatic generate COB ID by Slave Node ID and choose PDOx from Slave PDO. Alternatively, you can manually enter the COB ID when Slave PDO is set to "-- Select One --".
Transmission Type	Sync, RTR, Event	Sync	For TPDO: Sync. The MGate will send out TPDO following by the number of SYNC reached which set in the No. of SYNCs . RTR. The MGate will send out TPDO when received RTR bit ON in the slave RPDO, which COB ID is set in the previous setting. Event. The MGate will send out TPDO cyclic according to the Event Timer(ms). If the Event time is 0, then TPDO will send out when data changed. To use CAN bus loading efficiently, you can set the Inhibit Time(ms) to avoid sending TPDO too frequently. For RPDO: Sync. The MGate will update the slave TPDO data into internal memory only when SYNC message occurred. Event. The MGate updates the slave TPDO data into internal memory when received the slave TPDO.
No. of SYNCs (for Sync Type)	0 to 240	0	No. of SYNC messages. Value from 0 to 240.
Inhibit Time (ms) (for Event Type))	0 to 65535	0	This can be used to set a time that must wait after the sending of a PDO
Event Timer (ms)	0 to 65535	0	This time can be used to trigger an event which handles the sending of the PDO.
Fault Protection	Pause Proceed-Clear data to zero Proceed - Set to User Defined Value	Pause	Pause: The gateway will write the same data to the slave device. Proceed—Clear data to zero: The gateway will write zero values to the slave device. Proceed—Set to User Defined Value: A user-defined value will be written to the slave device.
Fault Timeout (ms)	100 to 65535	60000	Defines the communication timeout on the opposite side.
Bit Position	Automatic generated		Bit offset in the PDO data frame
Object index	Customer Object index/ sub-index		User can Add customer object or add quickly with index/sub-index from slave EDS parameter.
Data Type	1 to 7 Bit 1 to 8 Byte	1 Bit	Tag data type
Tag Name	Alphanumeric string		Create Tag names. Select tags in the northbound protocol setting.

Parameter	Value	Default	Description
Endian Swap	None Byte swap Reverse Reverse with byte swap	None	Swapping the data. The item may change with different tag type or length for raw data type. None: No swap Byte swap: Switch the order of bytes. 0x11 22 33 44 55 66 77 88 → 0x22 11 44 33 66 55 88 77 Reverse: Reverse the order of bytes. 0x11 22 33 44 55 66 77 88 → 0x88 77 66 55 44 33 22 11 Reverse with byte swap: Reverse the order of bytes first, then switch the order of bytes. 0x11 22 33 44 55 66 77 88 → 0x77 88 55 66 33 44 11 22

CANopen COB ID table

Communication Object	Function Code (4 bit, binary)	Node ID (dec)	COB ID (hex)
NMT	0000	0	0x000
SYNC	0001	0	0x080
EMCY	0001	1 to 127	0x081 to 0x0FF
TIME	0010	0	0x100
T_PDO 1	0011	1 to 127	0x181 to 1FF
R_PDO 1	0100	1 to 127	0x201 to 27F
T_PDO 2	0101	1 to 127	0x281 to 2FF
R_PDO 2	0110	1 to 127	0x301 to 37F
T_PDO 3	0111	1 to 127	0x381 to 3FF
R_PDO 3	1000	1 to 127	0x401 to 47F
T_PDO 4	1001	1 to 127	0x481 to 4FF
R_PDO 4	1010	1 to 127	0x501 to 57F
T_SDO	1011	1 to 127	0x581 to 5FF
R_SDO	1100	1 to 127	0x601 to 67F
Heartbeat	1110	1 to 127	0x701 to 77F

Add CANopen slave device into Slave Setting.

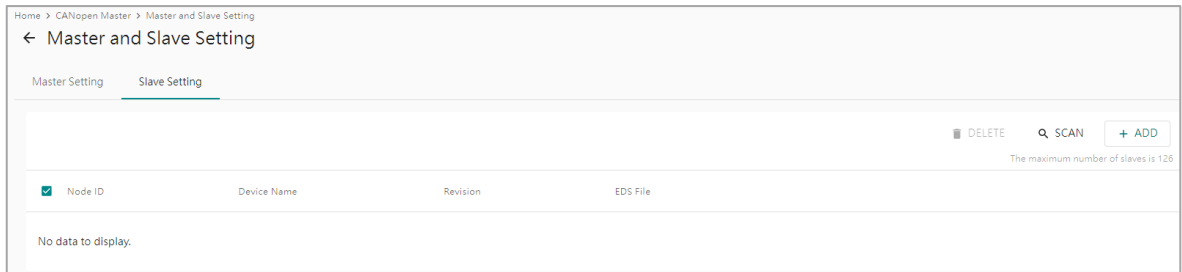

You can ADD slave device manually or SCAN the devices on the CANbus. Import the slave EDS files before adding or scanning the slave devices.

Click the ADD button and select the slave device from the EDS repository.

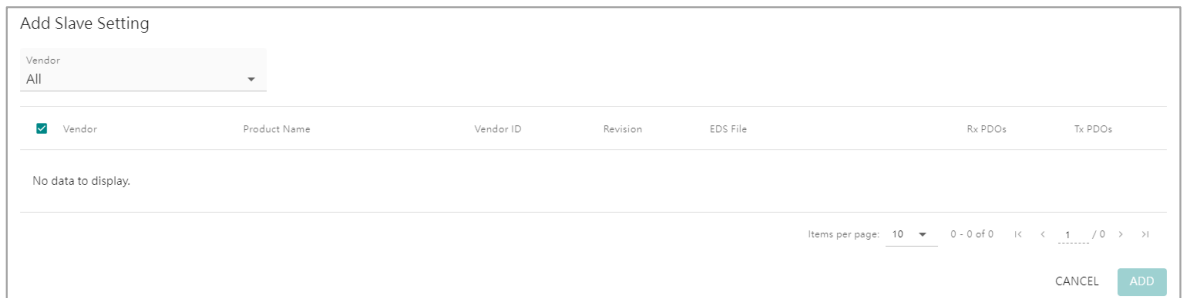

Or, click the SCAN button to scan the device on the CAN bus. Only the slave device that matches the EDS file in the EDS Repository will be added to the table.

Scan Slave Setting

STOP Capturing...

Auto Scroll

<input checked="" type="checkbox"/> Node ID	Vendor ID	Product Code	Revision	EDS File	Status
<div style="font-size: 2em; color: #008080; margin: 0 auto;">C</div>					

CANCEL
ADD

Click the pen icon to edit the slave Node ID and Device Name. Enable the **Enable device parameters initialization** setting. The MGate will send SDO requests to set the slave's communication parameters when the CANopen bus is ready. Select **Heartbeat** to retrieve the slave's status and set **Master Heartbeat Consuming Timeout** time for the CANopen slave parameter.

Edit Slave Setting

Node ID

1

Device Name

1

State Retrieval

Disabled

Disabled

Heartbeat

CANCEL
SAVE

Edit Slave Settings

Node ID

1

Device Name

1

Enable device parameters initialization ⓘ

State Retrieval

Heartbeat

Master Heartbeat Consuming Timeout (ms)

1000

CANCEL
SAVE

Heartbeat tag view status

Home > Tag View

Tag View

REFRESH

Provider	Source	Name	Type	Value	Timestamp	
canopen_master	1	status	int32	invalid (0x80000000)	2023-04-21T09:54:01.385+08:00	⋮
canopen_master	NMT	state	uint16	0x0000	2023-04-21T09:54:01.385+08:00	⋮
canopen_master	RPDO1	RPDO1	uint64	0x000000000004E65F	2023-04-20T18:15:58.295+08:00	⋮
canopen_master	TPDO1	TPDO1	uint64	0x000000000004E65F	2023-04-20T18:15:28.717+08:00	⋮

If you would like to initialize or change parameters default value of slave device when CAN bus ID is ready to send SDOs. Click the Edit device parameters.

Home > CANopen Master > Master and Slave Setting

← Master And Slave Setting

Master Setting Slave Setting

DELETED SCAN + ADD

The maximum number of slaves is 126

<input type="checkbox"/>	Node ID	Device Name	Revision	EDS File	
<input type="checkbox"/>	6	Driver	0.1	EDS CGDriver002_V003 -20190916-no rtr(1).eds	⋮

- Edit slave settings
- Edit device parameters
- Delete

In the following window, you can see the default value from the EDS file, and you may type in the new value in the value column, and then click the SAVE button.

Edit Device Parameters

Communication Profile Area

Index	Name	Value	Default Value
0x1014	COB-ID EMCY	<input type="text"/>	\$NODEID+0x80
0x1015	Inhibit Time Emergency	<input type="text"/>	0
> 0x1016	Heartbeat Consumer Entries		-
0x1017	Producer Heartbeat Time	<input type="text" value="1000"/>	0
> 0x1018	Identity Object		-
0x1019	Synchronous counter overflow value	<input type="text"/>	0
> 0x1029	Error Behaviour		-

CANCEL SAVE

Protocol Settings—J1939 Settings

Manage the J1939 protocol on this page.

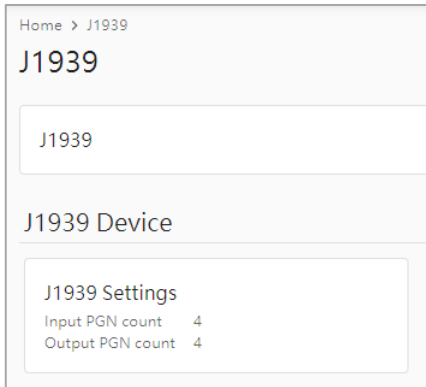

Configure J1939 settings in **Device Settings** tab.

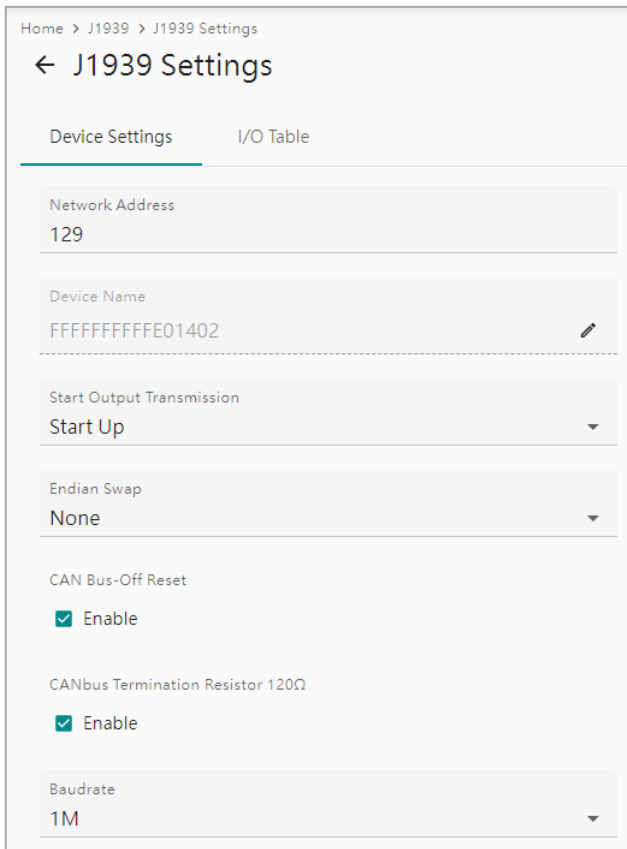

Parameter	Value	Default	Description
Network address	Numerical number	128 to 253	The MGate’s network address in the J1939 bus
Device name	The parameters regarding to J1939.	FFFFFFFFFFFFFFFF	A set of J1939 parameter combinations represented in hex value
Start output transmission by	Data update, startup	Data update	To determine the way the transmission starts

Parameter	Value	Default	Description
Endian swap	None Byte swap Reverse Reverse with byte swap	None	Swapping the data. The item may change with different tag type or length for raw data type. None: Don't need to swap Byte swap: Switch the order of bytes. 0x11 22 33 44 55 66 77 88 → 0x22 11 44 33 66 55 88 77 Reverse: Reverse the order of bytes. 0x11 22 33 44 55 66 77 88 → 0x88 77 66 55 44 33 22 11 Reverse with byte swap: Reverse the order of bytes first, then switch the order of bytes. 0x11 22 33 44 55 66 77 88 → 0x77 88 55 66 33 44 11 22
CAN bus-off reset	Disable, Enable	Disable	When some kind of J1939 bus error happens, the MGate will automatically stop communication with the J1939 bus. You may choose Enable to have the MGate rejoin the bus.
CANbus termination resistor 120 ohms	Disable, Enable	Disable	To enable 120 ohms termination resistor on CAN bus
Baudrate	250 kbps, 500 kbps, 1Mbps	250 kbps	The baudrate used in J1939

In the **I/O Table** tab, you can change the input/output commands of J1939. Click **ADD** to add the J1939 commands into the MGate, according to the J1939 device it is attached to.

Add I/O

Type
 Input Output

Name

Source Address

PGN

Message Offset
 (byte , bit)

Data Length
 (byte , bit)

Trigger

Update Interval

Home > J1939 > J1939 Settings

← J1939 Settings

Device Settings I/O Table

CLONE DELETE SCAN + ADD

<input type="checkbox"/>	Index	Type	Name	Network Address	PGN	Offset	Length	Priority	Trigger	Update Interval (ms)	
<input type="checkbox"/>	1	Input	Input256	128	256	0 (0, 0)	64 (8, 0)	-	Cyclic	0	✎ 🗑️ 📄
<input type="checkbox"/>	2	Output	Output256	128	256	0 (0, 0)	64 (8, 0)	6	Cyclic	10	✎ 🗑️ 📄
<input type="checkbox"/>	3	Input	Input512	128	512	0 (0, 0)	64 (8, 0)	-	Cyclic	0	✎ 🗑️ 📄
<input type="checkbox"/>	4	Output	Output512	128	512	0 (0, 0)	64 (8, 0)	6	Cyclic	10	✎ 🗑️ 📄
<input type="checkbox"/>	5	Input	Input768	128	768	0 (0, 0)	64 (8, 0)	-	Cyclic	0	✎ 🗑️ 📄
<input type="checkbox"/>	6	Output	Output768	128	768	0 (0, 0)	64 (8, 0)	6	Cyclic	10	✎ 🗑️ 📄
<input type="checkbox"/>	7	Input	Input1024	128	1024	0 (0, 0)	64 (8, 0)	-	Cyclic	0	✎ 🗑️ 📄
<input type="checkbox"/>	8	Output	Output1024	128	1024	0 (0, 0)	64 (8, 0)	6	Cyclic	10	✎ 🗑️ 📄

Parameter	Value	Default	Description
Type	Input, Output	Input	Data type
Name	(An alphanumeric string)	Command1	Max. 32 characters
Source Address	0 to 253, 255	0	Data from which J1939 device. Also listed as Network Address in the IO table.
Destination Address (for output)	0 to 253, 255	0	Data sent to which J1939 device. Also listed as Network Address in the IO table.
PGN	0 to 131071	0	Parameter Group Number
Message Offset	0 to 14279 bits	0 (0, 0)	The location where the data associated with the data point begins. The offset not only can be shown in bits but can be displayed as corresponding bytes and bits (byte, bit).
Data Length	0 to 14280 bits	0 (0, 0)	The length of the data to be transferred between the J1939 devices. The length not only can be shown in bits but also can be displayed as corresponding bytes and bits (byte, bit).
Trigger	Disable, Cyclic, Data Change	Cyclic	Disable: The command has never been sent Cyclic: The command is sent cyclically at the interval specified in the Poll Interval parameter. Data change: The data area is polled for changes at the time interval defined by Poll Interval. A command is issued when a change in data is detected.
Update interval	0 to 65535 ms	0	The desired update interval for the data in milliseconds.
Priority (for output)	0 to 7		Output PGN priority
Fault Protection (for output)	Pause Proceed—Clear data to zero Proceed—Set to User-defined Value	Keep Latest Data	Configure the criteria used to determine what to do when the write command is no longer received from the master side. For example, when a cable comes loose accidentally, the most up-to-date write command from the master side will not be received by the gateway. Pause: The gateway will write the same data to the slave device. Proceed—Clear data to zero: The gateway will write zero values to the slave device. Proceed—Set to User Defined Value: A user-defined value will be written to the slave device.

AutoScan:

For your convenience, the MGate is designed with an innovative command auto-learning function. It learns all the output commands from the J1939 devices in the same CAN bus. Users don't need to key in the commands one by one. All you have to do is click on the **SCAN** button, and a window will pop up. Click the Start button to learn. Click the pen icon at the right-hand side of the command to edit the command.

Whenever the commands are set, remember to click the APPLY button to save it.

Protocol Settings—CAN Proprietary Settings

Import or export offline excel CAN data frame configuration by clicking the IMPORT or EXPORT button on the right-hand side. Or, click CAN Port 1 to configure manually.

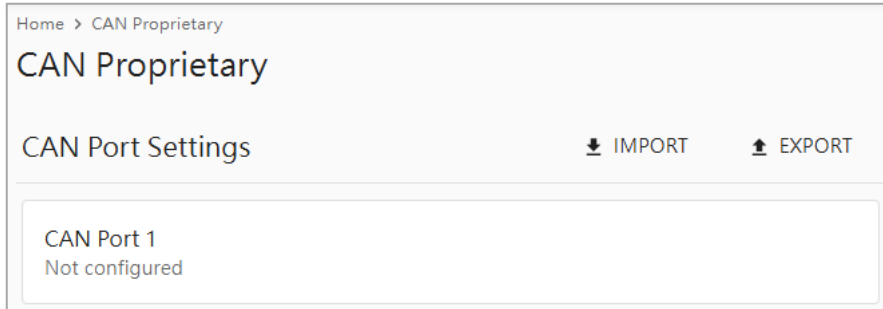

Click the EDIT button to set the CAN proprietary settings.

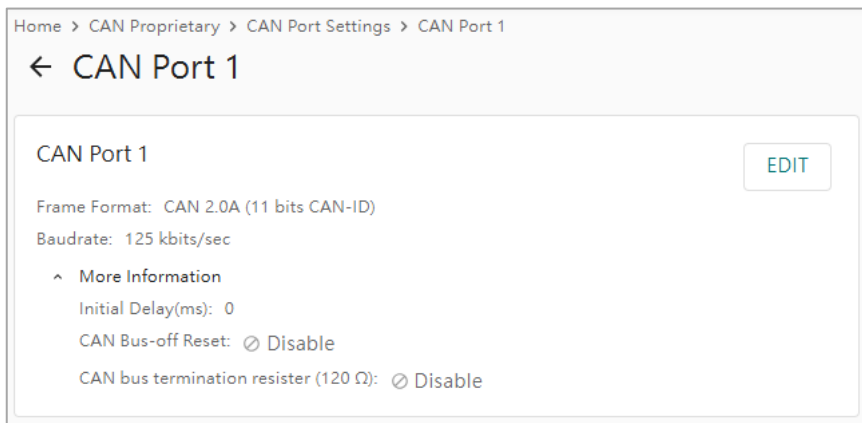

Select the CAN settings for CAN port 1. Click SAVE AS DRAFT button.

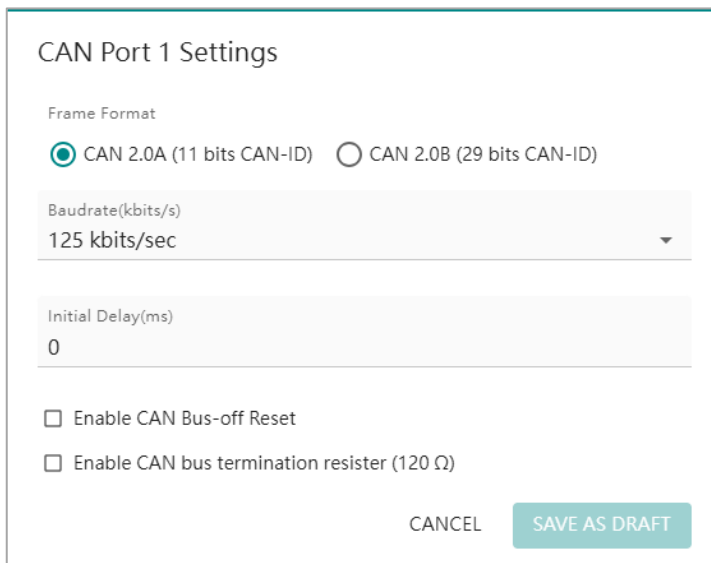

CAN Port 1 Settings

Parameter	Value	Default	Description
Frame Format	CAN 2.0A CAN 2.0B	CAN 2.0A	According to your CAN proprietary device, select either CAN 2.0A or 2.0B CAN data frame format.
Baudrate(kbits/s)	10 kbit/s 20 kbit/s 50 kbit/s 125 kbit/s 250 kbit/s 500 kbit/s 800 kbit/s 1 Mbit/s	125 kbit/s	Set CANopen network baudrate
Initial Delay(ms)	0 to 120000	0	For some CAN devices which need longer boot up time, the MGate needs to wait until the device is ready for communication. Set the initial delay time to wait the device boot-up.
CAN Bus-OFF Reset	Disable Enable	Disable	When the MGate detects the error count exceeding the CAN threshold, the CAN bus will switch to Bus Off mode, according to the CAN definition. Enable will auto reset the error count and restart the bus. Disable will stay in the Bus Off mode and only recovers when re-powering the MGate.
CAN bus termination resistor 120 ohms	Disable Enable	Disable	Software configurable CAN bus termination resistor.

Click ADD DEVICE to add the CAN devices, type in a 1- to 64-character device name. Click SAVE AS DRAFT to save the configuration temporarily.

Click ADD TRANSACTION button to select the CAN data frame type Produce, Consume, or Request/Response.

Follow a 3-step configuration for Produce Transaction, which the MGate will send CAN data to slave devices.

Home > CAN Proprietary > CAN Port Settings > CAN Port 1 > Add Produce Transaction

← Add Produce Transaction

1 Produce Settings 2 Frame Settings 3 Confirm

Enable transaction

Transaction Name
produce1

Trigger Mode
Cyclic

Cycle Interval(ms)
1000

Fault Protection
Proceed - Set to User-Defined Value

Info
Set the user-defined value in the data block under the frame settings in the next step.

Fault Timeout(ms)
60000

Trigger by RTR
When receiving a remote transmission request (RTR) for a specific CAN-ID, it triggers the produce transaction.

< BACK CANCEL NEXT >

Parameter	Value	Default	Description
Transaction Name	(An alphanumeric string)		1 to 64 characters.
Trigger Mode	Cyclic Data Change Boot-up	Cyclic	Cyclic: The transaction is sent cyclically at the interval specified in the Cyclic Interval parameter. Data change: The transaction is sent when a change in data is detected. Boot-up: The transaction is sent once the CAN bus boots up
Cyclic Interval(ms)	10 to 65535	1000	The desired cyclic interval in milliseconds.
Fault Protection	Pause Proceed—Clear data to zero Proceed—Set to User Defined Value	Pause	Pause: The gateway will write the same data to the slave device. Proceed—Clear data to zero: The gateway will write zero values to the slave device. Proceed—Set to User Defined Value: A user-defined value will be written to the slave device.
Fault Timeout(ms)	100 to 65535	60000	Defines the communication timeout on the opposite side.
Tigger by RTR	Disable Enable	Disable	When receiving a remote transmission request (RTR) for a specific CAN-ID, it triggers the produce transaction.

In the Frame Settings, type the CAN-ID according to the CAN device user manual first. Then click ADD FUNCTION BLOCK to add data blocks or constant blocks.

Home > CAN Proprietary > CAN Port Settings > CAN Port 1 > Add Produce Transaction

← Add Produce Transaction

1 Produce Settings 2 Frame Settings 3 Confirm

CAN-ID
0x 0000

Data Field ADD FUNCTION BLOCK ▾

Byte Offset	Name	Function Block	Length(byte)
No data to display. Click "ADD FUNCTION BLOCK" to add one.			

Data block
Constant block

< BACK

CANCEL NEXT >

Add Data Block

Name
data1

Tag Type
raw

Length(byte)
8

User-defined Value for Fault Protection (Hex)

	0	1	2	3	4	5	6	7	8	9
0	00	00	00	00	00	00	00	00	00	00

Endian Swap
None

CANCEL SAVE AS DRAFT

Parameter	Value	Default	Description
Name	(An alphanumeric string)		1 to 64 characters
Tag Type	raw, int 8, int 16, int 32, int 64, uint 8, uint 16, uint 32, uint 64, float, double	raw	Tag data type
Length(byte)	1 to 8	1	The default length for raw type is 1. The value is fixed for other data type except raw type.
User-defined Value for Fault Protection (Hex)		00	Set the user-defined value in the data block when you activate Fault Protection in the Produce Settings step and select "Proceed—Set to User-defined Value"

Parameter	Value	Default	Description
Endian Swap	None Byte swap Reverse Reverse with byte swap	None	Swapping the data. The item may change with different tag type or length for raw data type. None: Don't need to swap Byte swap: Switch the order of bytes. 0x11 22 33 44 55 66 77 88 → 0x22 11 44 33 66 55 88 77 Reverse: Reverse the order of bytes. 0x11 22 33 44 55 66 77 88 → 0x88 77 66 55 44 33 22 11 Reverse with byte swap: Reverse the order of bytes first, then switch the order of bytes. 0x11 22 33 44 55 66 77 88 → 0x77 88 55 66 33 44 11 22

Add Constant Block

Name
Constant

Length(byte)
1

Value
0x 00

CANCEL
SAVE AS DRAFT

Parameter	Value	Default	Description
Name	(An alphanumeric string)		1 to 32 characters.
Length(byte)	1 to 8	1	Data length of constant value.
Value	0x0000000000000000 to 0xFFFFFFFFFFFFFFFF	0x0000000000000000	Set the constant value in Hex.

The configuration will display the below Frame Settings.

Home > CAN Proprietary > CAN Port Settings > CAN Port 1 > Add Produce Transaction

← Add Produce Transaction

1 Produce Settings
 2 Frame Settings
 3 Confirm

CAN-ID
0x 0123

ADD FUNCTION BLOCK ▾

Byte Offset	Name	Function Block	Length(byte)
> 0-1	data1	Data	2
> 2-5	data2	Data	4
6-7	Constant 0x00FF	Constant	2

< BACK
CANCEL
NEXT >

Finally, confirm the transaction settings. Then, click SAVE AS DRAFT.

Home > CAN Proprietary > CAN Port Settings > CAN Port 1 > Add Produce Transaction

← Add Produce Transaction

✓ Produce Settings ————— ✓ Frame Settings ————— 3 Confirm

Produce Settings

Transaction Name: produce1
 Enable transaction: Enable
 Trigger Mode: Cyclic
 Cycle Interval(ms): 1000
 Fault Protection: Proceed - Set to User-Defined Value
 Fault Timeout(ms): 60000
 Trigger by RTR: Disable

Frame Settings

CAN-ID: 0x0123
 Frame Length(byte): 8

< BACK CANCEL SAVE AS DRAFT

Follow 3 steps configuration for Consume Transaction which MGate will receive data from CAN slave devices.

Home > CAN Proprietary > CAN Port Settings > CAN Port 1 > Add Consume Transaction

← Add Consume Transaction

1 Consume Settings ————— 2 Frame Settings ————— 3 Confirm

Enable transaction

Transaction Name
consume1

Consume Timeout
 If the consume transaction is not received within the timeout time, the device will be considered offline.

Timeout Time(ms)
10000

< BACK CANCEL NEXT >

Parameter	Value	Default	Description
Transaction Name	(An alphanumeric string)		1 to 64 characters.
Consume Timeout (ms)	10 to 65535	10000	The timeout value in milliseconds. If the consume transaction is not received within the timeout time, the device will be considered offline.

Type in the CAN-ID, according to the CAN device user manual. Click the ADD FUNCTION BLOCK button to add data blocks or constant blocks. The block setting is the same as the producer. Refer to the Produce Frame Settings' description.

Home > CAN Proprietary > CAN Port Settings > CAN Port 1 > Add Consume Transaction

← Add Consume Transaction

1 ✓ Consume Settings ————— 2 Frame Settings ————— 3 Confirm

CAN-ID
0x 0123

Data Field ADD FUNCTION BLOCK ▾

Byte Offset	Name	Function Block	Length(byte)
No data to display. Click "ADD FUNCTION BLOCK" to add one.			

Drop-down menu options: Data block, Constant block

< BACK CANCEL NEXT >

Confirm the transaction settings. Click SAVE AS DRAFT.

Home > CAN Proprietary > CAN Port Settings > CAN Port 1 > Add Consume Transaction

← Add Consume Transaction

1 ✓ Consume Settings ————— 2 ✓ Frame Settings ————— 3 Confirm

Consume Settings
Transaction Name: consume1
Enable transaction: Enable
Consume Timeout: Enable
Timeout Time(ms): 10000

Frame Settings
CAN-ID: 0x0123
Frame Length(byte): 8

< BACK CANCEL SAVE AS DRAFT

Regarding Request/Response Transaction, the MGate will send a request to the CAN device to query a data, and then wait for its response.

Home > CAN Proprietary > CAN Port Settings > CAN Port 1 > Add Request/response Transaction

← Add Request/Response Transaction

1 Request/Response Settings 2 Frame Settings 3 Confirm

Enable transaction

Transaction Name
ReadData

Request Response

Trigger Mode
Cyclic

Cycle Interval(ms)
1000

Fault Protection
Proceed - Set to User-Defined Value

Info
Set the user-defined value in the data block under the frame settings in the next step.

Fault Timeout(ms)
60000

Maximum retry(count) ⓘ
3

< BACK CANCEL NEXT >

Parameter	Value	Default	Description
Transaction Name	(An alphanumeric string)		1 to 64 characters.
Trigger Mode	Cyclic Data Change Boot-up	Cyclic	Cyclic: The transaction is sent cyclically at the interval specified in the Cyclic Interval parameter. Data change: The transaction is sent when a change in data is detected. Boot-up: The transaction is sent once the CAN bus boots up
Cyclic Interval (ms)	10 to 65535	1000	The desired cyclic interval in milliseconds.
Fault Protection	Pause Proceed—Clear data to zero Proceed—Set to User Defined Value	Pause	Pause: The gateway will write the same data to the slave device. Proceed—Clear data to zero: The gateway will write zero values to the slave device. Proceed—Set to User Defined Value: A user-defined value will be written to the slave device.
Fault Timeout (ms)	100 to 65535	60000	Defines the communication timeout on the opposite side.
Maximum retry (count)	0 to 5	0	The request retries counts when a timeout occurred without receiving a response. The response timeout value is set in the Response tab.

1 Request/Response Settings

Enable transaction

Transaction Name
ReadData

Request Response

Response Timeout(ms)
1000

Parameter	Value	Default	Description
Response Timeout (ms)	100 to 65535	1000	The desired response timeout value.

Here, set the request and response frame settings according to the CAN device user manual, including the CAN-ID, data blocks, or constant blocks. The block setting is the same as the producer. Refer to Produce Frame Settings' description.

✓ Request/Response Settings 2 Frame Settings 3 Confirm

Request Response

CAN-ID
0x 0123

Data Field ADD FUNCTION BLOCK ▾

Byte Offset	Name	Function Block	Length(byte)
No data to display. Click "ADD FUNCTION BLOCK" to add one.			

Data block
Constant block

✓ Request/Response Settings 2 Frame Settings 3 Confirm

Request Response

CAN-ID
0x 0001

Data Field ADD FUNCTION BLOCK ▾

Byte Offset	Name	Function Block	Length(byte)
No data to display. Click "ADD FUNCTION BLOCK" to add one.			

Data block
Constant block

Confirm the transaction settings. Then click **SAVE AS DRAFT**.

Home > CAN Proprietary > CAN Port Settings > CAN Port 1 > Add Request/response Transaction

← Add Request/Response Transaction

✓ Request/Response Settings ————— ✓ Frame Settings ————— 3 Confirm

Request/Response Settings

Transaction Name: ReadData
 Enable transaction: Enable

Request

Trigger Mode: Cyclic
 Cycle Interval(ms): 1000
 Fault Protection: Proceed - Set to User-Defined Value
 Fault Timeout(ms): 60000
 Maximum retry(count): 3

Response

Response Timeout(ms): 1000

Frame Settings

Request

CAN-ID: 0x0123
 Frame Length(byte): 8

Response

CAN-ID: 0x0001
 Frame Length(byte): 8

< BACK CANCEL **SAVE AS DRAFT**

After all settings have been created, click the icon on the right-hand side of each transaction to edit, delete or clone it. Finally, click **APPLY** to activate all settings.

Home > CAN Proprietary > CAN Port Settings > CAN Port 1

← CAN Port 1

CAN Port 1 EDIT

Frame Format: CAN 2.0A (11 bits CAN-ID)
 Baudrate: 125 kbits/sec
 ▾ More Information

ADD DEVICE **Sensor** ADD TRANSACTION ▾

No.	Transaction Name	Status	Transaction Type	CAN-ID	Frame Length(byte)	
1	produce1	✓ Enable	Produce	0x0123	8	⋮
2	consume1	✓ Enable	Consume	0x0123	8	Edit produce settings Edit frame settings Clone Delete
3	ReadData	✓ Enable	Request Response	0x0123 0x0001	8	

Items per page: 10 ▾ 1 - 3 of 3 ⏪ ⏩

DISCARD **APPLY**

Protocol Settings—PROFINET IO Device Settings

Configure the PROFINET IO Device setting on this page. The MGate 5123 supports two Application Relations (Ars) for two PLCs to access the same data via a shared device feature.

Home > PROFINET IO Device

PROFINET IO

PROFINET IO
Device Name: MANAGE

PROFINET IO Device

Application Relation 1		Application Relation 2	
Input data size	0	Input data size	0
Output data size	0	Output data size	0
Input slot	-	Input slot	-
Output slot	-	Output slot	-

Click **MANAGE** to edit PROFINET Device Name.

Edit PROFINET IO Device Name

Device Name

CANCEL
SAVE

Parameter	Value	Description
Device Name	<alphanumeric string>	Enter the PROFINET server name (if you type the name incorrectly, the connection will fail).

Click on the **Application Relation** button to add tag data.

Home > PROFINET IO Device > Application Relation 1

← Application Relation 1 ▾

Application Relation 1
Input data size: 0
Output data size: 0

I/O Mapping + ADD SLOT

Slot Number	Slot Name	Type	Slot Data Size (bytes)
1	Voltage	Input	10

Tag name	Data type	Byte index	Quantity (bytes)
canopen_master/NMT/state	uint16	0 - 1	2
canopen_master/RPDO1/ID2_TPDO1	uint64	2 - 9	8

Click **ADD SLOT** in the I/O Mapping to add tag data to PROFINET slots.

Add Slot

Slot Number
1

Type
Input ▼

Slot Name
Voltage

Auto Adjust Slot Size

Slot Data Size (bytes)
0

Select Tags

Info:
Select one or more tag providers to get their tags, and select tags to map data.

Providers
canopen_master ▼

2 Tags

Selected Tags
state (+1 more) ▼

CANCEL **SAVE**

Parameter	Value	Description
Slot number	1 to 128	Slot number in PROFINET IO Controller program develops environment setting
Type	Input Output	Input or output type to PROFINET IO Controller
Slot Name	<alphanumeric string>	Set the name for slot
Providers		Select what tag data you would like to map to PROFINET

On completing the PROFINET mappings, click **MANAGER** to export the GSDML files. A GSDML file is used for easy configuration when setting the PROFINET IO controller system. Typically, users waste a lot of time on importing the MGate 5123 general GSDML files and setting the IO modules, respectively. If we import the specified GSDML, which is based on Modbus settings, we just need to pull the module to the PROFINET system. Then, the IO modules will be set, and you can run the communication.

MANAGE

Edit

Export GSDML v2.25

Export GSDML v2.3

Export GSDML v2.42

Protocol Settings—SNMP Mapping Settings

Manage CAN to SNMP mapping data on this page. For detailed SNMP protocol settings, go to the SNMP Trap Server page.

Home > SNMP Mapping

SNMP Mapping

SNMP Mapping

NOTE:
For advanced settings, please go to [SNMP Trap Server page](#)

SNMP Setting

Data Mapping
0 tags

Home > SNMP Mapping > SNMP Setting

SNMP Setting

Data Mapping DELETE + ADD TAGS
The maximum number of tags is 1024

<input type="checkbox"/>	#	SNMP OID	Provider	Source	Name	
<input type="checkbox"/>	1	.1.3.6.1.4.1.8691.21.5122.3.1.1.1	canopen_master	RPDO1	RPDO1	^ v ⋮
<input type="checkbox"/>	2	.1.3.6.1.4.1.8691.21.5122.3.1.1.2	canopen_master	TPDO1	TPDO1	^ v ⋮
<input type="checkbox"/>	3	.1.3.6.1.4.1.8691.21.5122.3.1.1.3	canopen_master	1	status	^ v ⋮
<input type="checkbox"/>	4	.1.3.6.1.4.1.8691.21.5122.3.1.1.4	canopen_master	NMT	state	^ v ⋮

Click **ADD TAGS** to add tags in the CAN settings.

Add Tag

Info:
Select one or more tag providers to get their tags, and select tags to map data.

Providers
canopen_master ▼

1 Tags

Selected Tags
state ▼

CANCEL SAVE

The OID is defined as below:

OID	String	OID (string type)	Description
1.3.6.1.4.1.8691	moxa	1.3.6.1.4.1.8691	
1.3.6.1.4.1.8691.21	mgate	{moxa}.21	MGate Series
1.3.6.1.4.1.8691.21.5123	mgate5123	{mgate}.5123	Model name
1.3.6.1.4.1.8691.21.5123.1	swMgmt	{mgate5123}.1	SNMP management Information
1.3.6.1.4.1.8691.21.5123.2	trap	{mgate5123}.2	SNMP trap
1.3.6.1.4.1.8691.21.5123.3	mapping	{mgate5123}.3	SNMP mapping
1.3.6.1.4.1.8691.21.5123.3.1	tags	{mapping}.1	Tag mapping
1.3.6.1.4.1.8691.21.5123.3.1.1	array of values	{tags}.1	Tag value
1.3.6.1.4.1.8691.21.5123.3.1.2	array of names	{tags}.2	Tag name
1.3.6.1.4.1.8691.21.5123.3.1.1.x	value of array[x]	{array of values}.x	Index of tag value
1.3.6.1.4.1.8691.21.5123.3.1.2.x	name of array[x]	{array of names}.x	Index of tag name

Diagnostics

Diagnostics—Protocol Diagnostics

Diagnostics—Protocol Diagnostics—CANopen Diagnostics

Home > CANopen Diagnostics

CANopen Diagnostics

Autorefresh

Overview Slave Status

CAN Status

State : Error active

RX Count : 0

TX Count : 0

CRC Error : 0

Bit Error : 0

Stuff Error : 0

Bus-off Count : 0

CANopen Status

State : Operational

PDO RX Count : 0

PDO TX Count : 771

Time pkt Count : 0

SYNC pkt Count : 0

EMCY pkt Count : 0

Heart/State pkt Count : 0

In the Slave Status tab, check the detailed information regarding slave status and change the CANopen state machine at the right-hand side.

Furthermore, you can open the Object Parameter tab to check and change the slave device's CANopen object value.

Diagnostics—Protocol Diagnostics—J1939 Diagnostics

Home > J1939 Diagnostics

J1939 Diagnostics

Autorefresh

Diagnostics Live List

CAN Bus

State	: error active
Baudrate	: 1M bps
Bus-off count	: 0

J1939

Network address	: 255
Sent message	: 0
Received message	: 0

The Live List function allows you to check how many live devices are on the same network.

Home > J1939 Diagnostics

J1939 Diagnostics

Autorefresh

Diagnostics Live List

Address	Transmitted PGN count	Bus Load
No data to display.		

Diagnostics—Protocol Diagnostics—CAN Proprietary Diagnostics

Home > CAN Proprietary Diagnostics

CAN Proprietary Diagnostics

Auto Refresh

CAN Port 1

CAN Status

State	Error active
RX Count	0
TX Count	11
CRC Error	0
Bit Error	0
Stuff Error	0
Bus-off Count	0
Bus Loading	0%

Transaction Status

Device List
Sensor

Transaction List

Transaction Name	State	Failed Count
produce1	Failed	670095
consume1	Timeout	2
ReadData	Failed	670097

Diagnostics—Protocol Diagnostics- PROFINET Diagnostics

Home > PROFINET Diagnostics

PROFINET Diagnostics

Auto refresh

Application Relation 1 Application Relation 2

IO Controller Status

MAC Address	-
Operator Mode	-

Parameters

Update Time (ms)	-
Device Name	-

I/O Slots

Slot Number	Slot Name	Type	Data Size (bytes)	Data (hex byte)	Status
No Data					

Diagnostics—Protocol Traffic

Diagnostics—Protocol Traffic—CANopen Traffic

Click **START** to start traffic log.

Home > CANopen Traffic

CANopen Traffic

STOP Capturing...

Auto Scroll

Type: ALL Node ID:

[EXPORT](#) **TEST**

No.	Time	Tx/Rx	Node ID	Type	COB ID	Description	Data
1	0.752	Tx	2	RPDO1	0x0202	Receive PDO 1	00 00 00 00 00 00 00 00
2	0.762	Rx	2	TPDO1	0x0182	Transmit PDO 1	00 00 00 00 00 00 00 00
3	1.753	Tx	2	RPDO1	0x0202	Receive PDO 1	00 00 00 00 00 00 00 00
4	1.763	Rx	2	TPDO1	0x0182	Transmit PDO 1	00 00 00 00 00 00 00 00
5	2.758	Tx	2	RPDO1	0x0202	Receive PDO 1	00 00 00 00 00 00 00 00
6	2.769	Rx	2	TPDO1	0x0182	Transmit PDO 1	00 00 00 00 00 00 00 00
7	3.752	Tx	2	RPDO1	0x0202	Receive PDO 1	00 00 00 00 00 00 00 00
8	3.762	Rx	2	TPDO1	0x0182	Transmit PDO 1	00 00 00 00 00 00 00 00
9	4.755	Tx	2	RPDO1	0x0202	Receive PDO 1	00 00 00 00 00 00 00 00
10	4.765	Rx	2	TPDO1	0x0182	Transmit PDO 1	00 00 00 00 00 00 00 00

You can also read/write CAN data manually by clicking the **TEST** button and type in the CAN data frame.

Test

COB ID
0x 010

Data
0x01|

⌘ for separate (e.g., 0x12,0x34,0x56)

Diagnostics—Protocol Traffic—J1939 Traffic

Click **START** to start the J1939 traffic log.

Home > J1939 Traffic

J1939 Traffic

START Ready to capture

Auto Scroll

[EXPORT](#)

No.	Time	Send/Receive	Destination Address	Source Address	Priority	PGN	Data
No data to display.							

Diagnostics—Protocol Traffic—CAN Proprietary Traffic

Home > CAN Proprietary Traffic Log

CAN Proprietary Traffic Log

CAN Port 1

START Ready to capture

Auto Scroll **EXPORT**

No.	Time(ms)	Direction	CAN-ID	RTR	Data Length(byte)	Data(hex)
1	0.002	Receive	0x018F	Data Frame	8	00 00 00 00 00 00 00 00
2	0.005	Send	0x020F	Data Frame	8	01 00 01 00 01 00 01 00
3	0.006	Send	0x0210	Data Frame	8	01 00 01 00 01 00 01 00
4	0.007	Send	0x0201	Data Frame	8	01 00 01 00 01 00 01 00
5	0.007	Send	0x0202	Data Frame	8	01 00 01 00 01 00 01 00
6	0.009	Send	0x0203	Data Frame	8	01 00 01 00 01 00 01 00
7	0.010	Send	0x0204	Data Frame	8	01 00 01 00 01 00 01 00
8	0.010	Send	0x0205	Data Frame	8	01 00 01 00 01 00 01 00
9	0.011	Send	0x0206	Data Frame	8	01 00 01 00 01 00 01 00

Diagnostics—Event Log

Diagnostics—Event Log—Log View

Review and export all event information in the event log.

Event Log

Home > Event Log

EXPORT **CLEAR** **REFRESH**

ID	Severity	Category	Event Name	Source	Message	Timestamp
1	Information	Security	Login success	admin 10.122.8.171	Account 'admin' login successfully	2022-07-08T09:33:32.627+08:00
2	Warning	Security	Clear event log	admin 10.122.8.171	Clear event log	2022-07-08T09:33:18.867+08:00

Items per page: 10 1-2 of 2 << 1 / 1 >>

Diagnostics—Event Log—Policy Settings

The event policy settings allow the MGate to record important events in the Remote Log to Syslog server and the Local Log; the MGate stores up to 10,000 events.

The MGate can also send email alerts, SNMP Trap messages, or open/close the circuit of the relay output when a selected event was triggered.

Filter events for easy reading or expand by clicking the category, such as System. Tick or untick the events if you want to log it and select which channels you want to use by clicking the channel name. After changing the settings, please remember to SAVE it.

Event Group	Description
System	Start system, User trigger reboot, Power input failure, NTP update failure
Network	IP conflict, DHCP get IP/renew, IP changed, Ethernet link down
Security	Clear event log, Login success, Login failure, Account/group changed, Password reached lifetime, SSL certificate import, Syslog certificate import
Maintenance	Firmware upgrade success, Firmware upgrade failure, Configuration import success, Configuration import failure, Configuration export, Configuration changed, Load factory default
Modbus client	Server connected, Server disconnected, Command recovered, Command fail
Modbus server	Client connected; Client disconnected; Exception function
EtherNet/IP	Adapter connected; Adapter disconnected
PROFINET	I/O Device is connected, I/O Device is disconnected, I/O Controller is running, I/O Controller has stopped
CANopen	Device state changed; CAN bus-off; slave initialization failed
J1939	CAN bus-off
CAN proprietary	CAN Error Passive, CAN bus-off, Transaction Success, Transaction Failed, Transaction Timeout

Local Log Settings

Local Log Setting

Event Log Overwrite Policy

Overwrite the Oldest Event Log

Stop Recording Event Log

Log Capacity Warning

Capacity Threshold (%)

80

Warning By

SNMP Trap Email

CANCEL SAVE

Local Log Settings	Description
Event Log Overwrite Policy	Overwrites the oldest event log Stops recording event log
Capacity Threshold (%)	When the log amount exceeds the warning
Warning By	SNMP Trap Email

Remote Log Settings

Remote Log Settings

Syslog Server 1

Enable

TLS Authentication

Enable

Upload TLS files to the bottom section

IP Address

Port
514

Syslog Server 2

Enable

TLS Authentication

Enable

IP Address

Port
514

TLS Authentication

Common Name	Start Time	Expiration Time
No data to display.		

Client Certificate
 No file chosen

Client Key
 No file chosen

CA Certificate
 No file chosen

Remote Log Settings	Description
Syslog Server IP	IP address of a server that will record the log data
Syslog Server port	514
TLS Authentication	Enable TLS authentication. Note TLS files must be uploaded for a successful connection.

SNMP Trap Settings

SNMP Trap Server

Trap Service
 Active Inactive

For advanced settings, please go to [SNMP Trap Server](#) page

Email Settings

Email Setting

SMTP Service
Active ▼

Primary Server

Mail Server (SMTP)	Port
10.123.7.18	25

Security Connection
None ▼

Require Authentication

Username

Password

From (Email address)
test@moxa.com

To (Email address, separated by semicolon)
user@moxa.com

CANCEL
SAVE

Parameters	Description
Mail Server (SMTP)	The mail server's domain name or IP address.
Port	The mail server's IP port.
Security Connection	TLS STARTTLS STARTTLS-None None
Username	This field is for your mail server's username, if required.
Password	This field is for your mail server's password, if required.
From (Email address)	Email address from which automatic email warnings will be sent.
To (Email address, separated by semicolon)	Email addresses to which automatic email warnings will be sent.

Diagnostics—Tag View

This page displays the tag live value generated by field devices and updates the values periodically. It is an easy and useful tool if you want to check whether the MGate receives the correct data from field devices. The gateway's timestamp shows the time data was updated to the tag. For example, when the CANopen_master NMT state showing the master current state, 0 means the master is in operational mode, 1 it is in preoperational mode, and 2 it is stop mode.

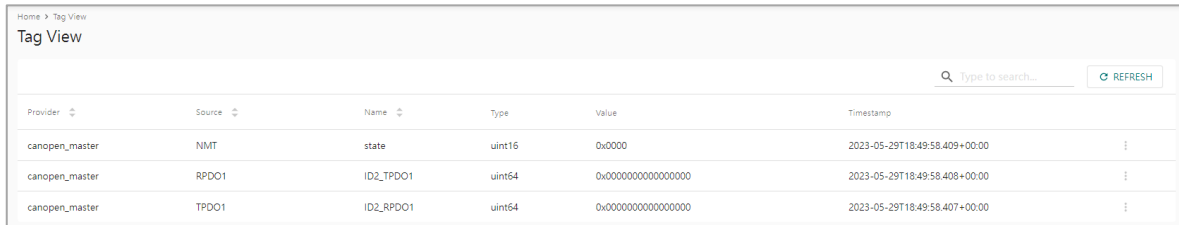

Home > Tag View
Tag View

Search: Type to search... REFRESH

Provider	Source	Name	Type	Value	Timestamp
canopen_master	NMT	state	uint16	0x0000	2023-05-29T18:49:58.409+00:00
canopen_master	RPDO1	ID2_TPDO1	uint64	0x0000000000000000	2023-05-29T18:49:58.408+00:00
canopen_master	TPDO1	ID2_RPDO1	uint64	0x0000000000000000	2023-05-29T18:49:58.407+00:00

Write a value to the CAN device via Write value directly to test the communication with the CAN device.

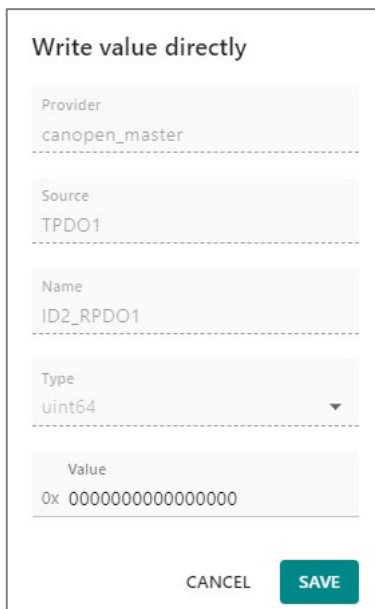

Write value directly

Provider
canopen_master

Source
TPDO1

Name
ID2_RPDO1

Type
uint64

Value
0x 0000000000000000

CANCEL SAVE

Diagnostics—Network Connections

See network-related information, including protocol, address, and state.

Network Connections					
Home > Network Connections					
<input checked="" type="checkbox"/> Auto refresh					
Protocol	Recv-Q	Send-Q	Local Address	Foreign Address	State
TCP	0	0	*:80	*:0	LISTEN
TCP	0	0	*:44818	*:0	LISTEN
TCP	0	0	*:22	*:0	LISTEN
TCP	0	0	*:443	*:0	LISTEN
TCP	34	0	10.123.4.44:35032	10.123.7.18:25	CLOSE_WAIT
TCP	0	0	10.123.4.44:443	10.122.8.171:53876	TIME_WAIT
TCP	0	255	10.123.4.44:443	10.122.8.171:53880	ESTABLISHED

Diagnostics—Ping

This network testing function is available only on the web console. The MGate gateway will send an ICMP packet through the network to a specified host, and the web console will immediately display the result.

Ping

Home > Ping

Ping Destination
192.168.127.2

ACTIVATE

Diagnostics—LLDP

See LLDP related information, including Port, Neighbor ID, Neighbor Port, Neighbor Port Description, and Neighbor System. Also, you can adjust the transmit interval for LLDP by clicking the **EDIT** button.

LLDP					
Home > LLDP					
LLDP Configuration					
LLDP Service (Disabled) Message Transmit Interval: 30 seconds					EDIT
LLDP Table					
REFRESH					
Interface	Neighbor ID	Neighbor Port	Neighbor Port Description	Neighbor System	
No Data					

To enable or disable the LLDP service after clicking EDIT, simply click on the "Service" hyperlink or go to Security > Service page.

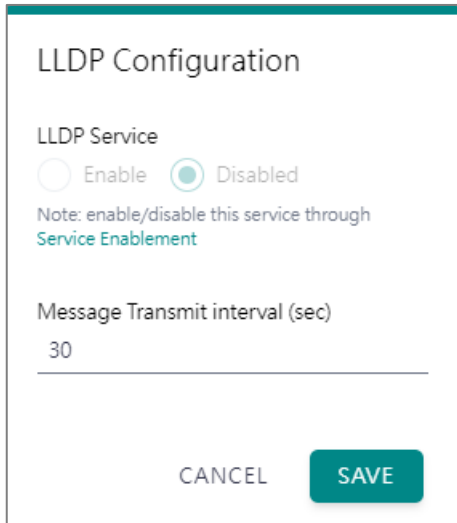

LLDP Configuration

LLDP Service

Enable Disabled

Note: enable/disable this service through [Service Enablement](#)

Message Transmit interval (sec)

30

CANCEL SAVE

Security

To secure your MGate, refer to the following security functions and configure it according to your requirements. We also provide a guideline of recommended steps as best practices for secure configurations in most applications. For this, refer to the Security Hardening Guide for the MGate 5000 Series.

Security—Account Management

Security—Account Management—Accounts

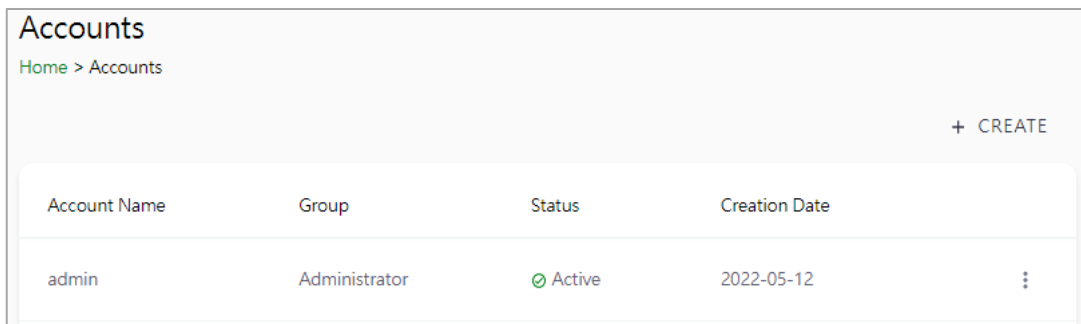

Accounts

Home > Accounts

+ CREATE

Account Name	Group	Status	Creation Date	
admin	Administrator	Active	2022-05-12	⋮

Only the Administrator group can create or edit accounts for user management. Click **CREATE** to add new accounts. Click the dot icon to edit the account.

Parameters	Value	Description
Group	Administrator, Operator, Guest	Users can change the password for different accounts. The MGate provides three build-in account groups: administrator, operator and guest. Administrator account can access all settings. Operator accounts can access most settings, except security categories. Guest account can only view the overview page. Create your own group for account management.

Security—Account Management—Groups

Three MGate build-in types of groups are shown; you can also create your own group by clicking **CREATE**.

Parameters	Value	Description
Basic Information		Includes Name and Description for the new Group.
Access Permissions	No display	Corresponding to the configuration menu on the left-hand side of the web console, you can select different permissions for a new group. Displays will not show the page on the right-hand side menu.
	Read only	
	Read write	

Security—Account Management—Password Policy

Password Policy

[Home](#) > Password Policy

Password Strength Setting

Password Minimum Length

Password Complexity Strength Check

Select all password strength requirements

- At least one digit (0-9)
- Mixed upper and lower case letters (A-Z, a-z)
- At least one special character (~! @\$%^&* _-+= \'\000;:"' <> ,.?)

Password Lifetime Setting

The password lifetime determines how long the password is effective. If password has expired, a popup message and event will notify user to change the password for security reasons.

Enable password lifetime check

Password Lifetime (day)

SAVE

Parameter	Value	Description
Password Minimum Length	8 to 128	The minimum password length
Password Complexity Strength Check		Selecting how the MGate checks the password's strength
Password lifetime Setting	90 to 180 days	Setting the password's lifetime period

Security—Service

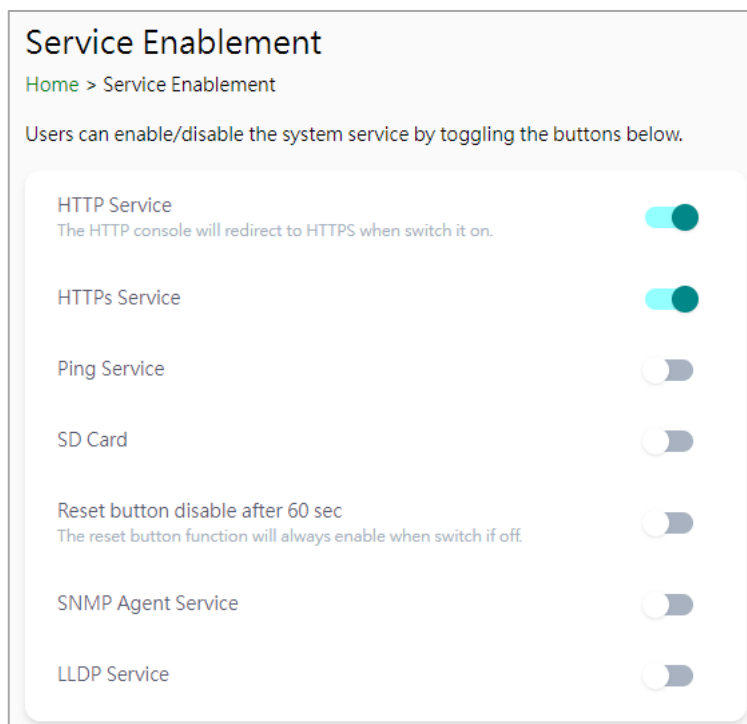

Parameter	Value	Description
HTTP Service	Enable/Disable	To enhance security, all HTTP requests will redirect to HTTPS when the HTTP service is enabled. You can also disable the HTTP service.
HTTPS Service	Enable/Disable	Disabling this service will disable the web console and search utility connections, thus cutting off access to the configuration settings. To re-enable the HTTPS communication, reset to the factory default settings via the hardware Reset button.
Ping Service	Enable/Disable	Disabling this service will block ping requests from other devices.
SD Card	Enable/Disable	Disabling this service will deactivate the SD card function for backup and restore configuration files.
SNMP Agent Service	Enable/Disable	Enable or disable SNMP agent function.
LLDP Service	Enable/Disable	Enable or disable LLDP function.
Reset button disable after 60 sec	Always enable and disable after 60 sec.	The MGate provides a Reset button to load factory default settings. For enhanced security, users can disable this function. In the disabled mode, the MGate will still enable the Reset button for 60 seconds after bootup, just in case you really need to reset the device.

Security—Allow List

These settings are used to restrict access to the MGate by the IP address. Only IP addresses on the list will be allowed to access the device. Notice the restriction includes configuration and protocol conversion.

Allow List

[Home](#) > [Allow List](#)

Activate the accessible IP list (All communications are NOT allowed for the IPs NOT on the list)

No.	Active	IP	Netmask
1	<input type="checkbox"/>	<input type="text"/>	<input type="text"/>
2	<input type="checkbox"/>	<input type="text"/>	<input type="text"/>
3	<input type="checkbox"/>	<input type="text"/>	<input type="text"/>
4	<input type="checkbox"/>	<input type="text"/>	<input type="text"/>
5	<input type="checkbox"/>	<input type="text"/>	<input type="text"/>

Security—DoS Defense

Select from several options to enable DoS Defense to fend off cybersecurity attacks. A denial-of-service (DoS) attack is an attempt to make a machine or a network resource unavailable. Select from the following options to counter DoS attacks.

DoS Defense

[Home](#) > [DoS Defense](#)

Configuration

Null Scan

NMAP-Xmax Scan

SYN/FIN Scan

FIN Scan

NMAP-ID Scan

SYN-Flood

Enable

Limit pkt/s

ICMP-Death

Enable

Limit pkt/s

SAVE

Security—Login Policy

Login Message

Input a message for Login or for Login authentication failure messages.

Login Policy

Home > Login Policy

Login Message Login Lockout Login Session

Login Message - optional
Hello

5 / 256

Login Authentication Failure Message
The account or password you entered is incorrect.(Your account will be temporarily locked if excessive tried.)

110 / 256

SAVE

Login Lockout

Login Policy

Home > Login Policy

Login Message Login Lockout Login Session

Enable Login Failure Lockout

Max Failure Retry Times
5

Reset the Login Failure Counter
This addition allows you to specify the maximum period of login failure counter.

Reset Period (min)
10

Lockout Time (min)
10

SAVE

Parameter	Value	Description
Max Failure Retry Times	1 to 10 (default 5)	Specify the maximum number of failures retries, if exceed the retry times, the MGate will lock out for that account login
Reset Period (min)	1 to 1440 (default 10)	Specify the reset period time when enabling the "reset the login failure counter" function
Lockout Time(min)	1 to 60 (default 10)	When the number of login failures exceeds the threshold, the MGate will lock out for a period.

Login Session

Login Policy

Home > Login Policy

Login Message Login Lockout **Login Session**

Maximum login user for HTTP+HTTPS
5

Auto logout setting (min)
1440

SAVE

Parameter	Value	Description
Maximum login users for HTTP+HTTPS	1 to 10 (default 5)	The number of users that can access the MGate simultaneously.
Auto logout setting (min)	1 to 1440 (default 1440)	Sets the auto logout period.

Security—Certificate Management

Use this function to load the Ethernet SSL certificate. Import or delete SSL certificate/key files. This function is only available for the web console.

Certificate Management

Home > Certificate Management

Configuration

Issue to	10.123.4.44
Issue by	Moxa Inc.
Valid	from 2022-6-2 to 2027-6-1

SSL

Select SSL Certificate	IMPORT
Delete SSL Certificate	DELETE

Maintenance

Maintenance—Configuration Import/Export

There are three main reasons for using the Import and Export functions:

- Applying the same configuration to multiple units. The Import/Export configuration function is a convenient way to apply the same settings to units in different sites. Export the configuration as a file and then import the configuration file onto other units.
- Backing up configurations for system recovery. The export function allows you to export configuration files that can be imported onto other gateways to restore malfunctioning systems within minutes.

Troubleshooting. Exported configuration files help administrators to identify system problems that provide useful information for Moxa’s Technical Service Team when maintenance visits are requested.

For cybersecurity reason, y export the configuration file with an authentication key, length from 8 to 16 characters. Importing will fail if config file keys don’t match between import and export files.

Home > Config. Import/Export

Config. Import/Export

Configuration File Authentication

Export configuration **EXPORT**

Import configuration Update network settings

Choose File No file chosen

IMPORT

Home > Config. Import/Export

Config. Import/Export

Configuration **File Authentication**

File authentication

Enable Disable

File authentication key

SAVE

Maintenance—Firmware Upgrade

Firmware updates for the MGate are available on the Moxa website. After you have downloaded the new firmware onto your PC, use the web console to write it onto your MGate. Select the desired unit from the list in the web console and click **Submit** to begin the process.



ATTENTION

DO NOT turn off the MGate power before you complete the firmware upgrade process. The MGate will erase the old firmware to make room for the new firmware to flash memory. If you power off the MGate and end the progress, the flash memory will contain corrupted firmware, and the MGate cannot boot. If this happens, contact Moxa RMA services.

The screenshot shows a web console page titled "Firmware Upgrade". At the top, there is a breadcrumb "Home > Firmware Upgrade". Below the title, a warning message states: "Upgrading firmware may cause device to reset to factory default. Back up the configuration of device." There is a file selection area with a "Choose File" button and the text "No file chosen". Below this is a large teal "UPLOAD" button.

Maintenance—Load Factory Default

To clear all the settings on the unit, use the Load Factory Default to reset the unit to its initial factory default values.

The screenshot shows a web console page titled "Load Factory Default". At the top, there is a breadcrumb "Home > Load Factory Default". Below the title, there is a warning message: "Click on Reset Button to reset all settings, including the console password, to the factory default values. The event log will remain after rebooting." There is a checkbox labeled "Keep Current IP Setting" which is currently unchecked. Below this is an information box with the text: "Info: To leave the IP address, netmask, and gateway settings unchanged, make sure that Keep IP settings is enabled." At the bottom is a large teal "RESET" button.



ATTENTION

Load Default will completely reset the configuration of the unit, and all the parameters you have saved will be discarded. Do not use this function unless you are sure you want to completely reset your unit.

Restart

Reboot the MGate by clicking the RESTART button.



ATTENTION

A reboot will discard unsaved configuration files.

Restart

Home > Restart

Clicking "Restart" will disconnect Ethernet connections and reboot the system.

RESTART

Status Monitoring

The Status Monitoring function provides status information of field devices when the MGate is being used as a CAN client. If a CAN device fails or a cable comes loose, the gateway won't be able to receive up-to-date data from the CAN device. The out-of-date data will be stored in the gateway's memory and will be retrieved by the client (e.g., PLC), which is not aware that the slave device is not providing up-to-date data. To handle this situation, the MGate provides a warning mechanism to report the list of slave devices that are still "alive" through the Status Monitoring function.

The MGate automatically creates a status tag when a CAN-based server device is created. This tag is used to show the connection status (valid or invalid) of the CAN-based server device. To monitor the status of the status tag, you can convert this tag to the northbound protocol and read for the northbound SCADA/device. Or, you can check the tag status on the MGate's web, the Tag View page.

To perform the status tag monitoring from your northbound protocol, go to the northbound protocol's page (for example, the PROFINET IO device page). Click ADD SLOT and select `canopen_master` as the tag provider and select the "status" tag. The MGate will automatically add a mapping from this CAN-based tag to the PROFINET.

Add Slot

Slot Number
1

Type
Input

Slot Name
Voltage

Auto Adjust Slot Size

Slot Data Size (bytes)
0

Select Tags

Info:
Select one or more tag providers to get their tags, and select tags to map data.

Providers
`canopen_master` 2 Tags

Selected Tags
`state` (+1 more)

CANCEL **SAVE**

The highest significant bit shows the status. 1 is invalid, 0 is valid.

Further details on the status codes:

1. Valid (0x00000000) - Indicates the status is connected.
2. Invalid (0x80000000) - Indicates the status is unknown.
3. Invalid (0x80000001) - Indicates the status is offline.

Provider	Source	Name	Type	Value	Timestamp
canopen_master	ID2	status	int32	invalid (0x80000001)	2023-06-19T17:47:39.118+00:00

4. Network Management Tool (MXstudio)

Moxa's MXstudio industrial network management suite includes tools such as MXconfig and MXview. MXconfig is for industrial network mass configuration; MXview is for industrial management software. For the software and related detailed information regarding MXview and MXconfig, as well as the supported product firmware versions, refer to the Moxa website at <https://www.moxa.com/en/products/industrial-network-infrastructure/network-management-software>.

When you discover a Moxa product that has not been integrated into the MXview or MXconfig, you may not be able to retrieve the product information from MXview or MXconfig. To solve this, you can download the plugin file from the Moxa MGate product website and then import/install the plugin into MXview or MXconfig.

After importing/installing the plugin files, the MGate products can be supported by MXview/MXconfig. Refer to the Moxa MGate product website to download plugin files: <http://www.moxa.com>. For more detailed functions such as supported functions on MXview/MXconfig, refer to the Tech Note: Configuring and Monitoring with MXview One/MXview and MXconfig.

A. SNMP Agents with MIB II

The MGate has built-in Simple Network Management Protocol (SNMP) agent software that supports SNMP Trap, and RFC 1213 MIB-II.

RFC1213 MIB-II Supported SNMP Variables

System MIB	Interfaces MIB	IP MIB	ICMP MIB
sysDescr	ifNumber	ipForwarding	icmpInMsgs
sysObjectID	ifIndex	ipDefaultTTL	icmpInErrors
sysUpTime	ifDescr	ipInReceives	icmpInDestUnreachs
sysContact	ifType	ipInHdrErrors	icmpInTimeExcds
sysName	ifMtu	ipInAddrErrors	icmpInParmProbs
sysLocation	ifSpeed	ipForwDatagrams	icmpInSrcQuenchs
sysServices	ifPhysAddress	ipInUnknownProtos	icmpInRedirects
	ifAdminStatus	ipInDiscards	icmpInEchos
	ifOperStatus	ipInDelivers	icmpInEchoReps
	ifLastChange	ipOutRequests	icmpInTimestamps
	ifInOctets	ipOutDiscards	icmpTimestampReps
	ifInUcastPkts	ipOutNoRoutes	icmpInAddrMasks
	ifInNUcastPkts	ipReasmTimeout	icmpInAddrMaskReps
	ifInDiscards	ipReasmReqds	icmpOutMsgs
	ifInErrors	ipReasmOKs	icmpOutErrors
	ifInUnknownProtos	ipReasmFails	icmpOutDestUnreachs
	ifOutOctets	ipFragOKs	icmpOutTimeExcds
	ifOutUcastPkts	ipFragFails	icmpOutParmProbs
	ifOutNUcastPkts	ipFragCreates	icmpOutSrcQuenchs
	ifOutDiscards	ipAdEntAddr	icmpOutRedirects
	ifOutErrors	ipAdEntIfIndex	icmpOutEchos
	ifOutQLen	ipAdEntNetMask	icmpOutEchoReps
	ifSpecific	ipAdEntBcastAddr	icmpOutTimestamps
		ipAdEntReasmMaxSize	icmpOutTimestampReps
		ipRouteDest	icmpOutAddrMasks
		ipRouteIfIndex	icmpOutAddrMaskReps
		ipRouteMetric1	
		ipRouteMetric2	
		ipRouteMetric3	
		ipRouteMetric4	
		ipRouteNextHop	
		ipRouteType	
		ipRouteProto	
		ipRouteAge	
		ipRouteMask	
		ipRouteMetric5	
		ipRouteInfo	
		ipNetToMediaIfIndex	
		ipNetToMediaPhysAddress	
		ipNetToMediaNetAddress	
		ipNetToMediaType	
		ipRoutingDiscards	

Address Translation MIB	TCP MIB	UDP MIB	SNMP MIB
atIfIndex	tcpRtoAlgorithm	udpInDatagrams	snmpInPkts
atPhysAddress	tcpRtoMin	udpNoPorts	snmpOutPkts
atNetAddress	tcpRtoMax	udpInErrors	snmpInBadVersions
	tcpMaxConn	udpOutDatagrams	snmpInBadCommunityNames
	tcpActiveOpens	udpLocalAddress	snmpInBadCommunityUses
	tcpPassiveOpens	udpLocalPort	snmpInASNParseErrs
	tcpAttemptFails		snmpInTooBigs
	tcpEstabResets		snmpInNoSuchNames
	tcpCurrEstab		snmpInBadValues
	tcpInSegs		snmpInReadOnlys
	tcpOutSegs		snmpInGenErrs
	tcpRetransSegs		snmpInTotalReqVars
	tcpConnState		snmpInTotalSetVars
	tcpConnLocalAddress		snmpInGetRequests
	tcpConnLocalPort		snmpInGetNexts
	tcpConnRemAddress		snmpInSetRequests
	tcpConnRemPort		snmpInGetResponses
	tcpInErrs		snmpInTraps
	tcpOutRsts		snmpOutTooBigs
			snmpOutNoSuchNames
			snmpOutBadValues
			snmpOutGenErrs
			snmpOutGetRequests
			snmpOutGetNexts
			snmpOutSetRequests
			snmpOutGetResponses
			snmpOutTraps
			snmpEnableAuthenTraps
			snmpSilentDrops
			snmpProxyDrops