

# MX-ROS V3

## User Manual

**Version 1.10**

January 2025



# Table of Contents

|  |           |
|--|-----------|
| <b>Overview</b> .....  | <b>23</b> |
| <b>Introduction</b> .....  | <b>24</b> |
| <b>What's in This Document</b> .....                                       | <b>25</b> |
| <b>Who This Document Is For</b> .....                                      | <b>26</b> |
| <b>Supported Series and Firmware Versions</b> .....                        | <b>27</b> |
| <b>Supported Features List</b> .....                                       | <b>28</b> |
| <b>Document Conventions</b> .....  | <b>35</b> |
| <b>Quick Start</b> .....   | <b>36</b> |
| <b>Using a Web Browser to Configure the Industrial Secure Router</b> ..... | <b>37</b> |
| <b>UI Reference</b> .....  | <b>40</b> |
| <b>UI Reference Overview</b> .....   | <b>41</b> |
| <b>The MX-ROS User Interface</b> .....                                     | <b>42</b> |
| <b>Options Menu</b> .....  | <b>43</b> |
| Options Menu - User Privileges .....                                       | 43        |
| Reboot .....   | 43        |
| Reset to Default Settings .....  | 44        |
| Save Custom Default .....  | 44        |
| Log Out.....   | 45        |
| <b>Device Summary</b> .....  | <b>46</b> |
| Model Information .....  | 46        |
| Panel Status .....   | 47        |
| <i>Panel View</i> .....  | 48        |
| System Event Summary (Last 3 days).....                                    | 50        |
| CPU Usage History (%) .....  | 51        |
| Memory Usage History (%).....  | 51        |

|  |            |
|--|------------|
| <b>Setup Wizard .....</b>                                      | <b>53</b>  |
| Port Type.....   | 53         |
| Interface .....  | 54         |
| <i>LAN IP Configuration .....</i>                              | <i>55</i>  |
| <i>WAN IP Configuration .....</i>                              | <i>55</i>  |
| <i>PPTP Dialup.....</i>  | <i>55</i>  |
| <i>PPPoE Dialup .....</i>                                      | <i>56</i>  |
| Service.....   | 56         |
| Confirm.....   | 57         |
| <b>System .....</b>  | <b>58</b>  |
| System - User Privileges.....                                  | 58         |
| System Management .....  | 59         |
| <i>Information Settings .....</i>                              | <i>60</i>  |
| <i>Firmware Upgrade.....</i>                                   | <i>61</i>  |
| <i>Software Package Management .....</i>                       | <i>65</i>  |
| <i>Configuration Backup and Restore.....</i>                   | <i>68</i>  |
| Account Management.....  | 80         |
| <i>User Accounts .....</i>                                     | <i>80</i>  |
| <i>Password Policy .....</i>                                   | <i>85</i>  |
| <i>License Management .....</i>                                | <i>87</i>  |
| <i>Adding a New License.....</i>                               | <i>88</i>  |
| Management Interface .....                                     | 96         |
| <i>Out of Band Management.....</i>                             | <i>96</i>  |
| <i>User Interface .....</i>                                    | <i>98</i>  |
| <i>Hardware Interface (all products except TN Series).....</i> | <i>101</i> |
| <i>Hardware Interface (TN Series only).....</i>                | <i>102</i> |
| <i>SNMP .....</i>  | <i>103</i> |

|  |            |
|--|------------|
| <i>Moxa Remote Connect</i> .....           | 106        |
| <i>MXsecurity</i> .....                    | 112        |
| <i>Ping Response</i> .....                 | 113        |
| Time.....                                  | 118        |
| <i>System Time</i> .....                   | 118        |
| <i>NTP/SNTP Server</i> .....               | 127        |
| Power Management.....                      | 128        |
| <i>Power Management - General</i> .....    | 128        |
| <i>Power Management - Scheduling</i> ..... | 129        |
| <i>Power Management - Ignition</i> .....   | 137        |
| SMS.....                                   | 139        |
| <i>SMS - General</i> .....                 | 140        |
| <i>Add Trusted Number Entry</i> .....      | 141        |
| <i>Edit Trusted Number Entry</i> .....     | 142        |
| <i>Delete Trusted Number Entry</i> .....   | 143        |
| <i>Remote Control List</i> .....           | 143        |
| <i>Send SMS</i> .....                      | 145        |
| GNSS.....                                  | 146        |
| <i>GNSS - General</i> .....                | 146        |
| <i>GNSS Client</i> .....                   | 147        |
| <i>GNSS Server</i> .....                   | 148        |
| Status.....                                | 149        |
| Setting Check.....                         | 150        |
| <b>Cellular</b> .....                      | <b>152</b> |
| Cellular - User Privileges.....            | 152        |
| Cellular - General.....                    | 152        |
| SIM Settings.....                          | 153        |

|   |            |
|---|------------|
| <i>Reordering SIM Card Priority</i> .....     | 153        |
| <i>Changing the Active SIM Card</i> .....     | 154        |
| <i>SIM Card List</i> .....                    | 154        |
| GuaranLink .....                              | 156        |
| <i>GuaranLink Settings</i> .....              | 157        |
| <i>GuaranLink Recovery Settings</i> .....     | 158        |
| Cellular - Status .....                       | 161        |
| <i>Cellular Status</i> .....                  | 162        |
| <i>Cellular Module Information</i> .....      | 163        |
| <i>Carrier and SIM</i> .....                  | 164        |
| <i>Signal Status</i> .....                    | 165        |
| <b>Serial</b> .....                           | <b>166</b> |
| Serial - User Privileges .....                | 166        |
| Serial - Port Settings.....                   | 166        |
| <i>Port Buffering and Logs Settings</i> ..... | 168        |
| Operation Mode.....                           | 169        |
| <i>Operation Mode - Real COM</i> .....        | 169        |
| <i>Operation Mode - TCP Server</i> .....      | 171        |
| <i>Operation Mode - TCP Client</i> .....      | 174        |
| <i>Operation Mode - UDP</i> .....             | 179        |
| Data Packing.....                             | 182        |
| <i>Delimiter Settings</i> .....               | 183        |
| Serial - Status.....                          | 184        |
| <i>Error Counter</i> .....                    | 184        |
| <i>Serial Counter</i> .....                   | 185        |
| <i>Serial State</i> .....                     | 185        |
| <i>Serial - Connection List</i> .....         | 186        |

|  |            |
|--|------------|
| Serial Data Logs .....                       | 186        |
| <b>Network Configuration .....</b>           | <b>187</b> |
| Network Configuration - User Privileges..... | 187        |
| Ports.....                                   | 188        |
| <i>Port Settings</i> .....                   | 188        |
| <i>Link Aggregation</i> .....                | 193        |
| <i>PoE</i> .....                             | 195        |
| <i>Link Fault Passthrough</i> .....          | 208        |
| <i>LAN Bypass Gen3</i> .....                 | 209        |
| Layer 2 Switching .....                      | 211        |
| <i>VLAN</i> .....                            | 211        |
| <i>MAC Address Table</i> .....               | 218        |
| <i>QoS</i> .....                             | 219        |
| <i>Rate Limit</i> .....                      | 225        |
| <i>Multicast</i> .....                       | 228        |
| Network Interfaces .....                     | 237        |
| <i>LAN</i> .....                             | 238        |
| <i>WAN/WAN1</i> .....                        | 244        |
| <i>WAN2/DMZ</i> .....                        | 252        |
| <i>Bridge</i> .....                          | 264        |
| <i>MTU Configuration</i> .....               | 267        |
| <i>Secondary IP</i> .....                    | 268        |
| <i>Virtual Interface</i> .....               | 271        |
| <b>Redundancy .....</b>                      | <b>274</b> |
| Redundancy - User Privileges .....           | 274        |
| Layer 2 Redundancy .....                     | 274        |
| <i>Spanning Tree</i> .....                   | 275        |

|   |            |
|---|------------|
| <i>Turbo Ring V2</i> .....                          | 280        |
| <i>Turbo Chain</i> .....                            | 285        |
| Layer 3 Redundancy .....                            | 287        |
| <i>VRRP</i> .....                                   | 287        |
| WAN Redundancy .....                                | 297        |
| <i>WAN Redundancy - Settings</i> .....              | 297        |
| <i>WAN Redundancy - Status</i> .....                | 301        |
| <b>Network Service</b> .....                        | <b>302</b> |
| Network Service - User Privileges .....             | 302        |
| DHCP Server.....                                    | 302        |
| <i>DHCP Server - General</i> .....                  | 303        |
| <i>DHCP</i> .....                                   | 303        |
| <i>DHCP Server - MAC-based IP Assignment</i> .....  | 308        |
| <i>DHCP Server - Port-based IP Assignment</i> ..... | 312        |
| <i>DHCP Server - Lease Table</i> .....              | 317        |
| <i>DHCP Relay Agent</i> .....                       | 318        |
| Dynamic DNS.....                                    | 320        |
| DNS Server .....                                    | 322        |
| <i>DNS Server - Global</i> .....                    | 322        |
| <i>DNS Server - Settings</i> .....                  | 323        |
| <b>Routing</b> .....                                | <b>325</b> |
| Routing - User Privileges .....                     | 325        |
| Unicast Route.....                                  | 326        |
| <i>Static Routes</i> .....                          | 326        |
| <i>RIP</i> .....                                    | 329        |
| <i>OSPF</i> .....                                   | 332        |
| <i>Routing Table</i> .....                          | 350        |

|  |            |
|--|------------|
| Multicast Route .....                        | 351        |
| <i>Multicast Route Settings</i> .....        | 352        |
| <i>Static Multicast Route</i> .....          | 352        |
| <i>Multicast Forwarding Table</i> .....      | 355        |
| Broadcast Forwarding .....                   | 356        |
| <i>Broadcast Forwarding Settings</i> .....   | 356        |
| <i>Broadcast Forwarding List</i> .....       | 357        |
| <b>NAT.....</b>                              | <b>360</b> |
| NAT - User Privileges .....                  | 360        |
| NAT Rule List .....                          | 360        |
| <i>Edit NAT Rule</i> .....                   | 361        |
| <i>Create Index</i> .....                    | 362        |
| <i>Delete NAT Rule</i> .....                 | 378        |
| <b>Object Management.....</b>                | <b>379</b> |
| Object Management - User Privileges .....    | 379        |
| <i>Edit Object</i> .....                     | 380        |
| <i>Create Object</i> .....                   | 386        |
| <i>Delete Object</i> .....                   | 394        |
| <b>Firewall .....</b>                        | <b>395</b> |
| Network Configuration - User Privileges..... | 395        |
| Layer 2 Policy.....                          | 396        |
| Layer 3-7 Policy .....                       | 404        |
| <i>Layer 3-7 Policy Settings</i> .....       | 405        |
| <i>Layer 3-7 Policy List</i> .....           | 406        |
| Layer 3 Policy.....                          | 414        |
| <i>Layer 3 Policy Settings</i> .....         | 415        |
| <i>Layer 3 Policy List</i> .....             | 415        |



|   |            |
|---|------------|
| Malformed Packets.....                        | 429        |
| Session Control .....                         | 430        |
| DoS Policy .....                              | 437        |
| <i>DoS Log Settings</i> .....                 | 437        |
| <i>DoS Settings</i> .....                     | 438        |
| Soft Lockdown Mode .....                      | 439        |
| Advanced Protection .....                     | 441        |
| <i>Dashboard</i> .....                        | 442        |
| <i>Configuration</i> .....                    | 444        |
| <i>Protocol Filter Policy</i> .....           | 485        |
| <i>ADP</i> .....                              | 488        |
| <i>IPS</i> .....                              | 490        |
| Device Lockdown .....                         | 496        |
| <i>Device Lockdown - Settings</i> .....       | 497        |
| <i>Device Lockdown - Learning Table</i> ..... | 499        |
| <b>VPN .....</b>                              | <b>502</b> |
| VPN - User Privileges .....                   | 502        |
| IPSec .....                                   | 502        |
| <i>Global Settings</i> .....                  | 503        |
| <i>IPSec Settings</i> .....                   | 503        |
| <i>IPSec Status</i> .....                     | 527        |
| L2TP Server .....                             | 528        |
| <i>Server Setting (WAN)</i> .....             | 528        |
| <i>User Name Settings</i> .....               | 529        |
| OpenVPN Client.....                           | 530        |
| <i>OpenVPN Client - Settings</i> .....        | 531        |
| <i>OpenVPN Client - Status</i> .....          | 532        |

|   |            |
|---|------------|
| <b>Certificate Management</b> .....           | <b>534</b> |
| Certificate Management - User Privileges..... | 534        |
| Local Certificate .....                       | 535        |
| Trusted CA Certificate .....                  | 538        |
| Certificate Signing Request .....             | 539        |
| <i>Key Pair Generate</i> .....                | 540        |
| <i>CSR Generate</i> .....                     | 541        |
| <b>Security</b> .....                         | <b>545</b> |
| Security - User Privileges.....               | 545        |
| Device Security .....                         | 546        |
| <i>Login Policy</i> .....                     | 546        |
| <i>Trusted Access</i> .....                   | 547        |
| <i>SSH &amp; SSL</i> .....                    | 550        |
| Network Security.....                         | 553        |
| <i>IEEE 802.1X</i> .....                      | 553        |
| Authentication.....                           | 559        |
| <i>Login Authentication</i> .....             | 560        |
| <i>RADIUS</i> .....                           | 561        |
| <i>TACACS+</i> .....                          | 562        |
| MXview Alert Notification.....                | 564        |
| <i>Security Notification Setting</i> .....    | 564        |
| <i>Security Status</i> .....                  | 565        |
| <b>Diagnostics</b> .....                      | <b>567</b> |
| Diagnostics - User Privileges .....           | 567        |
| System Status .....                           | 568        |
| <i>Utilization</i> .....                      | 568        |
| <i>Fiber Check</i> .....                      | 570        |

|   |            |
|---|------------|
| Network Status .....                          | 572        |
| <i>Network Statistics</i> .....               | 572        |
| <i>LLDP Settings</i> .....                    | 576        |
| <i>ARP Table</i> .....                        | 577        |
| Event Logs and Notifications .....            | 578        |
| <i>Event Log</i> .....                        | 579        |
| <i>Event Notifications</i> .....              | 599        |
| <i>Syslog</i> .....                           | 610        |
| <i>SNMP Trap/Inform</i> .....                 | 612        |
| <i>Email Settings</i> .....                   | 617        |
| <i>SMS Settings</i> .....                     | 619        |
| Tools.....                                    | 621        |
| <i>Port Mirroring</i> .....                   | 622        |
| <i>Ping</i> .....                             | 623        |
| <i>Diagnostic Support</i> .....               | 624        |
| <i>NetFlow</i> .....                          | 625        |
| <b>Industrial Application .....</b>           | <b>631</b> |
| IEC 61375 Setting .....                       | 631        |
| <i>Ethernet Train Backbone</i> .....          | 631        |
| <i>Communication Profile</i> .....            | 645        |
| <i>Operational Status</i> .....               | 652        |
| <b>Other Features .....</b>                   | <b>661</b> |
| <b>Firmware Image Recovery Overview .....</b> | <b>662</b> |
| Methodology .....                             | 662        |
| How Dual-imaging Works.....                   | 663        |
| <b>Soft Lockdown .....</b>                    | <b>665</b> |
| Soft Lockdown Criteria .....                  | 665        |
| Entering Soft Lockdown Mode .....             | 666        |

|   |            |
|---|------------|
| When in Soft Lockdown Mode.....   | 666        |
| Leaving Soft Lockdown Mode .....  | 667        |
| <b>Serial Operation Modes.....</b>                                      | <b>668</b> |
| Operation Mode - Real COM .....   | 669        |
| Operation Mode - RFC 2217 .....   | 670        |
| Operation Mode - TCP Server .....                                       | 670        |
| Operation Mode - TCP Client .....                                       | 671        |
| Operation Mode - UDP.....   | 672        |
| <b>Device Applications .....</b>  | <b>673</b> |
| <b>Device Applications Overview.....</b>                                | <b>674</b> |
| <b>Network Segmentation .....</b>                                       | <b>675</b> |
| <i>About Network Segmentation .....</i>                                 | <i>675</i> |
| <i>VLANs in Depth.....</i>  | <i>675</i> |
| <i>Scenario: Layer 2 Segmentation of 3 Factories .....</i>              | <i>677</i> |
| <i>Scenario: Layer 3 Segmentation of Two Services .....</i>             | <i>684</i> |
| <b>About Redundancy.....</b>  | <b>693</b> |
| What kinds of redundancy protocols are there? .....                     | 693        |
| About Layer 2 Redundancy Protocols.....                                 | 693        |
| <i>About Scenarios for Turbo Chain and Turbo Ring.....</i>              | <i>695</i> |
| About Turbo Ring v2 .....   | 696        |
| <i>About Ring Coupling.....</i>   | <i>697</i> |
| <i>Scenario: Using Turbo Ring in a Manufacturing Plant .....</i>        | <i>698</i> |
| <i>Scenario: Using Turbo Ring in an On-board Train Application.....</i> | <i>702</i> |
| About RSTP .....  | 706        |
| <i>How RSTP Works .....</i>   | <i>707</i> |
| <i>Scenario: RSTP on 4 Network Devices .....</i>                        | <i>708</i> |
| About Turbo Chain .....   | 711        |
| <i>Example: Configuring Turbo Chain .....</i>                           | <i>714</i> |

|  |            |
|--|------------|
| About VRRP .....   | 715        |
| <i>Benefits of VRRP</i> .....  | 716        |
| <i>About VRRP States</i> .....   | 716        |
| <i>VRRP in Depth</i> .....   | 717        |
| <i>Scenario: VRRP on Two Routers</i> .....                               | 719        |
| <b>Routing</b> .....   | <b>722</b> |
| About Routing .....  | 722        |
| <i>Routing and Packet Delivery</i> .....                                 | 723        |
| <i>About Static Routing</i> .....  | 723        |
| <i>About Multicast Routing</i> .....                                     | 724        |
| <i>About Selecting a Routing Protocol</i> .....                          | 725        |
| Example: Adding a Static Unicast Route for Factory Automation .....      | 726        |
| Example: Adding Static Multicast Route for Passenger Speed Display ..... | 728        |
| <b>About OpenVPN Client</b> .....  | <b>731</b> |
| Scenario: Using a Site-to-Site OpenVPN Tunnel .....                      | 731        |
| <i>Configuring the Router as an OpenVPN Client</i> .....                 | 731        |
| <i>Example: Configuring NAT to Translate over OpenVPN</i> .....          | 732        |
| <b>About NetFlow</b> .....   | <b>735</b> |
| NetFlow In Depth .....   | 735        |
| <i>NetFlow Exporter</i> .....  | 735        |
| <i>NetFlow Collector</i> .....   | 735        |
| <i>NetFlow Analyzer</i> .....  | 735        |
| Scenario: Using NetFlow to Collect LAN Interface Data .....              | 736        |
| <i>Example: Configuring the Router as a NetFlow Exporter</i> .....       | 738        |
| <b>About Loopback Interfaces</b> .....                                   | <b>741</b> |
| Scenario: Connecting Two Subnets .....                                   | 741        |
| <i>Sample Topology</i> .....   | 742        |

|   |            |
|---|------------|
| <i>Setup</i> .....  | 742        |
| <i>Example: Configuring a Loopback Interface for IPSec Tunnel #1</i> .....                            | 743        |
| <i>Example: Configuring NAT to Translate to the Loopback Interface</i> .....                          | 744        |
| <b>About NAT</b> .....  | <b>747</b> |
| NAT in Depth .....  | 747        |
| Types of NAT .....  | 747        |
| NAT Advantages .....  | 748        |
| Scenario: NAT for Renewable Power Generators .....  | 748        |
| <i>Example: Configuring 1-to-1 NAT for Device Management</i> .....                                    | 749        |
| <b>About L2TP</b> .....   | <b>752</b> |
| Scenario: Configuring L2TP with IPSec for Corporate VPN .....   | 752        |
| <i>Example: Configuring L2TP Server</i> .....   | 753        |
| <i>Example: Configuring IPSec for L2TP Server</i> .....   | 753        |
| <b>About IPSec</b> .....  | <b>755</b> |
| Remote Access to Control Systems .....  | 755        |
| Interconnecting Facilities .....  | 755        |
| Regulatory Compliance .....   | 755        |
| Sensitive Data Handling .....   | 756        |
| Cybersecurity Enhancement .....   | 756        |
| Interfacing with IoT Devices .....  | 756        |
| Disaster Recovery and Backup .....  | 756        |
| Scenario: Using IPSec to Configure Site-to-site VPNs .....  | 756        |
| <i>Example: Configuring Field Site Device as a Server for Site-to-site VPN</i><br><i>Access</i> ..... | 758        |
| <i>Example: Configure Remote Site Device as a Client for Site-to-site VPN</i><br><i>Access</i> .....  | 758        |
| <b>Railway Applications</b> .....   | <b>760</b> |
| <b>Overview of IEC 61375 for Rail Applications</b> .....  | <b>761</b> |

|  |            |
|--|------------|
| Ease of Coupling/Decoupling .....  | 761        |
| Simplify On-board Device Communication .....                             | 761        |
| Failover Supports Redundancy.....  | 762        |
| <b>Getting to Know IEC 61375 .....</b>                                   | <b>763</b> |
| About Communication Profiles (IEC 61375-2-3).....                        | 763        |
| <i>Train Real-time Data Protocol (TRDP)</i> .....                        | 764        |
| <i>Train Topology Database (TTDB)</i> .....                              | 764        |
| <i>ETB Control Service Provider (ECSP) and Client (ECSC)</i> .....       | 764        |
| <i>TCN Domain Name System (TCN-DNS)</i> .....                            | 765        |
| <i>TCN Uniform Resource Identifier (TCN-URI)</i> .....                   | 765        |
| <i>Safe Data Transmission (SDTv2)</i> .....                              | 765        |
| <i>IEC 61375-2-3 Terms</i> .....   | 765        |
| About Ethernet Train Backbones (IEC 61375-2-5).....                      | 766        |
| <i>Ethernet Train Backbone Node (ETBN)</i> .....                         | 766        |
| <i>Train Topology Discovery Protocol (TTDP)</i> .....                    | 766        |
| About Ethernet Consist Networks (IEC 61375-3-4) .....                    | 767        |
| <i>Ethernet Device (ED)</i> .....  | 767        |
| <i>Railway-Network Address Translation (R-NAT)</i> .....                 | 767        |
| <b>Scenario: 2 Consists, Each with 2 Redundant ETBNs/ECSPs .....</b>     | <b>768</b> |
| About Traffic Flows in ETBNs .....                                       | 768        |
| <i>Network Topology</i> .....  | 768        |
| <i>T=0 Getting Camera IP</i> .....                                       | 769        |
| <i>T=1 DIP/SIP</i> .....   | 770        |
| <i>T=2 R-NAT Translation from Consist 1</i> .....                        | 770        |
| <i>T=3 R-NAT Translation to Consist 2</i> .....                          | 771        |
| Example: Configuring 2 Consists with 2 Redundant ETBN Routers Each ..... | 772        |
| <i>Example: Configuring TTDP for ETBN Router 1 on Consist 1</i> .....    | 773        |

|  |            |
|--|------------|
| <i>Example: Configuring TTDP for ETBN Router 2 on Consist 1</i> .....    | 776        |
| <i>Example: Configuring TTDP for ETBN Router 1 on Consist 2</i> .....    | 778        |
| <i>Example: Configuring TTDP for ETBN Router 2 on Consist 2</i> .....    | 781        |
| Checking End-Device IPs .....  | 783        |
| Getting ECSP Data with a Network Analyzer.....                           | 784        |
| Getting ECSP Data with the Web GUI .....                                 | 786        |
| <b>Scenario: 2 Consists, with 1 ETBN/ECSP Each</b> .....                 | <b>788</b> |
| Example: Configuring 2 Consists with 1 ETBN/ECSP Each .....              | 788        |
| <i>Example: Configuring TTDP for ETBN Router on Consist 1</i> .....      | 790        |
| <i>Example: Configuring TTDP for ETBN Router on Consist 2</i> .....      | 792        |
| <b>Example: Configuring Communication Profiles for ETBNs/ECSPs</b> ..... | <b>795</b> |
| <b>Security Hardening Guide</b> .....                                    | <b>797</b> |
| <b>Security Hardening Guide Overview</b> .....                           | <b>798</b> |
| <b>Security Best Practices</b> .....                                     | <b>799</b> |
| Introduction to Defense in Depth.....                                    | 799        |
| Product Security .....   | 799        |
| <i>Physical Installation Guidelines</i> .....                            | 799        |
| <i>Account Management Guidelines</i> .....                               | 800        |
| <i>Protecting Vulnerable Network Ports</i> .....                         | 801        |
| Maintaining Communication Integrity .....                                | 801        |
| <i>Communication Integrity Features</i> .....                            | 802        |
| Device Access Control Best Practices.....                                | 803        |
| <i>Configuring Allowlists in Compliance with IEC 61162-460</i> .....     | 805        |
| <i>About Device Integrity and Authenticity</i> .....                     | 806        |
| <i>Securing USB Interfaces on Network Devices</i> .....                  | 807        |
| Device Resource Management and Monitoring .....                          | 808        |
| <i>Device Resource Monitoring</i> .....                                  | 808        |
| <i>Event Logs</i> .....  | 808        |



|  |            |
|--|------------|
| <i>Denial of Service (DoS) Protection</i> .....                      | 809        |
| <i>Session Control</i> .....   | 809        |
| Recommended Settings for Services and Features .....                 | 810        |
| Common Threats and Countermeasures .....                             | 811        |
| Recommended Operational Roles and Duties.....                        | 812        |
| <i>Administrator</i> .....   | 812        |
| <i>Supervisor</i> .....  | 813        |
| <i>Auditor</i> .....   | 813        |
| Recommended Patching and Backup Practices.....                       | 814        |
| <i>Firmware Upgrade</i> .....  | 814        |
| <i>Configuration Backup</i> .....                                    | 815        |
| Recommendations for Vulnerability Management .....                   | 815        |
| <b>Recommendations for Decommissioning</b> .....                     | <b>816</b> |
| Recommendations for Decommissioning .....                            | 816        |
| <b>Using Security Features</b> .....                                 | <b>817</b> |
| Introduction to IPS .....  | 817        |
| <i>What is the difference between IDS and IPS?</i> .....             | 817        |
| IPS Applications .....   | 818        |
| <i>IPS Limitations</i> .....   | 818        |
| Example: Updating the Network Security Package via the Web GUI ..... | 819        |
| Example: Updating the Network Security Package via MXsecurity .....  | 820        |
| Example: Configuring IPS Rules via MXsecurity .....                  | 821        |
| Example: Configuring IPS rules via WebGUI.....                       | 822        |
| Introduction to Firewalls.....                                       | 822        |
| <i>Stateful vs. Stateless firewalls</i> .....                        | 823        |
| <i>Categories of Firewall</i> .....                                  | 823        |
| <i>When to Use Firewalls</i> .....                                   | 824        |

|   |            |
|---|------------|
| Scenario: Airport Integrated Solutions .....                                    | 824        |
| <i>Sub-Systems in an Airport Network:</i> .....                                 | 825        |
| <i>Interoperability and Security</i> .....                                      | 825        |
| <i>Moxa's Solution</i> .....  | 825        |
| <i>Allowlist Firewall Configuration</i> .....                                   | 825        |
| <i>Example: Allowing ATMS-ALCMS traffic</i> .....                               | 826        |
| <i>Example: Configuring Blocked Traffic (Air)</i> .....                         | 827        |
| Scenario: Railway Integrated Solutions .....                                    | 828        |
| <i>Understanding Railway Network Topology</i> .....                             | 828        |
| <i>Allowlist Firewall Configuration</i> .....                                   | 829        |
| <i>Example: Allowing TCMS traffic</i> .....                                     | 830        |
| <i>Example: Allowing the T2G to access TCMS and PA/PIS</i> .....                | 831        |
| <i>Example: Configuring Blocked Traffic (Rail)</i> .....                        | 833        |
| <b>Security Standards and Concepts .....</b>                                    | <b>835</b> |
| AAA .....   | 835        |
| <i>About AAA - Authentication, Authorization, and Accounting</i> .....          | 835        |
| <i>About Authentication Types</i> .....   | 836        |
| ISA/IEC 62443 Standards and Architecture.....                                   | 842        |
| <i>Security Reference Standards</i> .....                                       | 842        |
| <i>ISA/IEC 62443 Standards and Architecture</i> .....                           | 843        |
| <i>Establishing Foundational Requirements</i> .....                             | 845        |
| <i>FR 1 Applications: User Identification and Authentication</i> .....          | 847        |
| <i>Product Lifecycle and Security</i> .....                                     | 848        |
| Product Security Context .....  | 849        |
| <i>Security Context of an Industrial Secure Router</i> .....                    | 850        |
| <i>Security Context of an Industrial Ethernet Switch</i> .....                  | 851        |
| <b>Appendix .....</b>   | <b>852</b> |
| <b>All Settings for Example Scenario: 2 Consists with 1 ETBN/ECSP Each.....</b> | <b>853</b> |

|  |            |
|--|------------|
| <b>All Settings for Example Scenario: 2 Consists with 2 Redundant ETBN</b> |            |
| <b>Routers Each .....</b>  | <b>855</b> |
| <b>Destination Ports for Layer 3 – 7 Protocol .....</b>                    | <b>857</b> |
| <b>Ethernet Protocol Default Ports .....</b>                               | <b>859</b> |
| <b>EtherTypes for Layer 2 .....</b>  | <b>862</b> |
| <b>Fiber Check Threshold Values .....</b>                                  | <b>864</b> |
| <b>Glossary .....</b>  | <b>867</b> |
| 1-to-1 NAT .....   | 867        |
| Broadcast Forwarding .....   | 867        |
| CoS Mapping.....   | 867        |
| Dead Interval.....   | 867        |
| Double NAT.....  | 867        |
| DSCP Mapping .....   | 868        |
| Hello Interval .....   | 868        |
| Hello Packet.....  | 868        |
| IEC 61735 .....  | 868        |
| IKE .....  | 869        |
| Link-State Advertisement Packet (LSA) .....                                | 869        |
| MTU (Maximum Transmission Unit) .....                                      | 869        |
| N-to-1 NAT .....   | 869        |
| NAT Loopback .....   | 869        |
| Network Address Translation (NAT) .....                                    | 869        |
| Port Address Translation (PAT) .....                                       | 870        |
| VRRP Binding .....   | 870        |
| <b>IEC 61162-460 Supplementary Declaration .....</b>                       | <b>871</b> |
| Preface.....   | 871        |
| Explanation .....  | 871        |
| Supplementary Declaration .....  | 871        |

|   |            |
|---|------------|
| <b>IEC 61375-2-3 Communication Identifiers .....</b>  | <b>873</b> |
| <b>IEC-104 Cause of Transmission List.....</b>        | <b>876</b> |
| <b>IEC-104 Type Identification List .....</b>         | <b>878</b> |
| Process information in monitor direction .....        | 878        |
| Process telegrams with long time tag (7 octets) ..... | 879        |
| Process information in control direction .....        | 879        |
| Command telegrams with long time tag (7 octets).....  | 880        |
| System information in monitor direction .....         | 880        |
| System information in control direction .....         | 881        |
| Parameter in control direction .....                  | 881        |
| File transfer .....                                   | 881        |
| <b>LED Behavior .....</b>                             | <b>883</b> |
| EDF-G1002 Series LED Behavior.....                    | 883        |
| EDR-8010 Series LED Behavior.....                     | 884        |
| EDR-G9004 Series LED Behavior .....                   | 886        |
| EDR-G9010 Series LED Behavior .....                   | 887        |
| <b>MIB Groups.....</b>                                | <b>889</b> |
| MIB Tree Structure .....                              | 889        |
| <b>MMS Command Type List .....</b>                    | <b>906</b> |
| <b>MMS Service Operation List .....</b>               | <b>907</b> |
| <b>PoE Configuration Suggestions .....</b>            | <b>911</b> |
| <b>Sample Local Consist Info File .....</b>           | <b>912</b> |
| <b>Installation.....</b>                              | <b>913</b> |
| Physical Installation .....                           | 913        |
| Account Management .....                              | 913        |
| Vulnerable Network Ports.....                         | 914        |
| Operation .....                                       | 914        |

|  |            |
|--|------------|
| <b>Maintenance .....</b>                                     | <b>918</b> |
| <b>Decommission .....</b>                                    | <b>919</b> |
| <b>Severity Level List .....</b>                             | <b>920</b> |
| <b>Status Codes.....</b>                                     | <b>921</b> |
| PoE Status Codes .....                                       | 921        |
| <i>Classification .....</i>                                  | <i>921</i> |
| <i>Device Type .....</i>                                     | <i>921</i> |
| <i>Configuration Suggestion .....</i>                        | <i>922</i> |
| <b>Structure and Syntax of Local Consist Info Files.....</b> | <b>923</b> |
| consistinfo .....  | 923        |
| <i>Attributes.....</i>                                       | <i>923</i> |
| <i>Child Elements.....</i>                                   | <i>923</i> |
| functioninfo .....   | 924        |
| <i>Attributes.....</i>                                       | <i>924</i> |
| <i>Child Elements.....</i>                                   | <i>924</i> |
| vehicleinfo .....  | 925        |
| <i>Attributes.....</i>                                       | <i>925</i> |
| <i>Child Elements.....</i>                                   | <i>925</i> |
| <b>System Event List .....</b>                               | <b>927</b> |
| <b>TRDP Message Type List .....</b>                          | <b>934</b> |
| Configuration attribute requirements - msgType .....         | 934        |
| Configuration attribute requirements - msgType Profile ..... | 934        |
| <b>TRDP Protocol Filter Profile List.....</b>                | <b>935</b> |
| <b>User Role Privileges.....</b>                             | <b>936</b> |
| System .....   | 936        |
| Cellular .....   | 937        |
| Serial .....   | 937        |

|                              |     |
|------------------------------|-----|
| Network Configuration .....  | 938 |
| Redundancy .....             | 938 |
| Network Service .....        | 939 |
| Routing .....                | 939 |
| NAT .....                    | 940 |
| Object Management .....      | 940 |
| Firewall .....               | 940 |
| VPN .....                    | 941 |
| Certificate Management ..... | 941 |
| Security .....               | 941 |
| Diagnostics .....            | 942 |
| Industrial Application ..... | 943 |

# Chapter 1

---

# Overview

# Introduction

Welcome to the Moxa RouterOS (MX-ROS) manual. This comprehensive guide is designed to help you understand and navigate the UI features, technical concepts, and tasks you may encounter while using your MX-ROS device. The goal is to simplify your experience and make the setup process easier.



# What's in This Document

This document includes the following sections:

- **Overview:** This section introduces this document and how to use it.
- **Quick Start:** This section tells you how to connect to your device so you can start using and configuring it.
- **UI Reference:** This section goes through the web user interface (UI) of your device to help you quickly understand what settings are available. This section also shows you the valid ranges and defaults for settings, and any limitations there may be when configuring your device.
- **Other Features:** This section helps you understand features for your device that may not have a related user interface.
- **Device Applications:** This section goes through various applications and helps you understand the related technologies, product features, and best practices so you can better configure the device for your own needs.
- **Security Hardening Guide:** This section gives you an overview of industrial network security and the related product features and best practices needed to help you better secure your application.
- **Appendix:** This section provides additional reference information for your device.

# Who This Document Is For

We want you to get the most out of your Moxa device, so we designed this document with these audiences in mind:

- **OT engineers learning how to configure OT network devices:** For frontline personnel operating in OT environments, keeping your MX-ROS configuration up-to-date is crucial. We created the **Security** section to help you better understand how you can use this device effectively for your application.
- **Experienced OT network engineers integrating Moxa devices into OT network infrastructure:** For those who already have a solid understanding of networking concepts, the **UI Reference** section is designed to give you a quick reference for all the device settings, options, default settings, and limitations. You may also find the **Security** section useful for learning how to get more out of your Moxa device and to optimize your application.

# Supported Series and Firmware Versions

| Moxa Router Series         | Firmware Version |
|----------------------------|------------------|
| <b>EDR-8000 Series</b>     | v3.14            |
| <b>EDR-G9000 Series</b>    | v3.14            |
| <b>EDF-G1000 Series</b>    | v3.14            |
| <b>OnCell G4000 Series</b> | v3.14            |
| <b>TN-4900 Series</b>      | v3.14            |
| <b>NAT-100 Series</b>      | v3.15            |

**Note**

Before upgrading a NAT-100 Series device from v1.x to v3.15, we suggest saving the previous version's configuration first, then redoing the device's configuration after the upgrade to prevent compatibility issues.

The information in this document is applicable to other products and firmwares that use MX-ROS V3, but the appearance and availability of features and settings may vary. For more information about which features are supported by each product series, refer to the [Supported Features List](#).

MX-ROS support may expand to other products in the future; please check the [Moxa website](#) for the latest information.

# Supported Features List

Support for various features varies depending on the product and model. Refer to the table below for an overview of which features are supported by different product series.

**Note**

Please note that there may still be functional differences between different models within the same product series.

| Configuration Section          | Function   | EDR Series | EDF Series | OnCell Series | TN Series | NAT Series |
|--------------------------------|--|------------|------------|---------------|-----------|------------|
| <a href="#">Device Summary</a> |  | YES        | YES        | YES           | YES       | YES        |
| <a href="#">Setup Wizard</a>   |  | YES        | -          | -             | YES       | YES        |
| <a href="#">System</a>         |  | YES        | YES        | YES           | YES       | YES        |
|                                | <a href="#">System Management</a>                | YES        | YES        | YES           | YES       | YES        |
|                                | <a href="#">Information Settings</a>             | YES        | YES        | YES           | YES       | YES        |
|                                | <a href="#">Firmware Upgrade</a>                 | YES        | YES        | YES           | YES       | YES        |
|                                | <a href="#">Software Package Management</a>      | YES        | YES        | YES           | YES       | -          |
|                                | <a href="#">Configuration Backup and Restore</a> | YES        | YES        | YES           | YES       | YES        |
|                                | <a href="#">Account Management</a>               | YES        | YES        | YES           | YES       | YES        |
|                                | <a href="#">User Accounts</a>                    | YES        | YES        | YES           | YES       | YES        |
|                                | <a href="#">Password Policy</a>                  | YES        | YES        | YES           | YES       | YES        |
|                                | <a href="#">License Management</a>               | YES        | YES        | YES           | YES       | -          |
|                                | <a href="#">Management Interface</a>             | YES        | YES        | YES           | YES       | YES        |
|                                | <a href="#">Out of Band Management</a>           | -          | YES        | -             | -         | -          |
|                                | <a href="#">User Interface</a>                   | YES        | YES        | YES           | YES       | YES        |
|                                | <a href="#">Ping Response</a>                    | YES        | YES        | YES           | YES       | YES        |

| Configuration Section | Function                                     | EDR Series | EDF Series | OnCell Series | TN Series | NAT Series |
|-----------------------|--|------------|------------|---------------|-----------|------------|
|                       | <a href="#">Hardware Interface</a>           | YES        | YES        | YES           | YES       | -          |
|                       | <a href="#">SNMP</a>                         | YES        | YES        | YES           | YES       | YES        |
|                       | <a href="#">Moxa Remote Connect</a>          | -          | -          | YES           | YES       | -          |
|                       | <a href="#">MXsecurity</a>                   | YES        | YES        | YES           | YES       | -          |
|                       | <a href="#">Time</a>                         | YES        | YES        | YES           | YES       | YES        |
|                       | <a href="#">System Time</a>                  | YES        | YES        | YES           | YES       | YES        |
|                       | <a href="#">NTP/SNTP Server</a>              | YES        | -          | YES           | -         | YES        |
|                       | <a href="#">Power Management</a>             | -          | -          | YES           | -         | -          |
|                       | <a href="#">SMS</a>                          | -          | -          | YES           | -         | -          |
|                       | <a href="#">GNSS</a>                         | -          | -          | YES           | -         | -          |
|                       | <a href="#">Setting Check</a>                | YES        | YES        | YES           | YES       | YES        |
|                       | <b><a href="#">Cellular</a></b>              | -          | -          | YES           | -         | -          |
|                       | <b><a href="#">Serial</a></b>                | -          | -          | YES           | -         | -          |
|                       | <b><a href="#">Network Configuration</a></b> | YES        | YES        | YES           | YES       | YES        |
|                       | <a href="#">Ports</a>                        | YES        | YES        | YES           | YES       | YES        |
|                       | <a href="#">Port Settings</a>                | YES        | YES        | YES           | YES       | YES        |
|                       | <a href="#">Link Aggregation</a>             | YES        | -          | -             | YES       | -          |
|                       | <a href="#">PoE</a>                          | -          | -          | -             | YES       | -          |
|                       | <a href="#">Link Fault Passthrough</a>       | YES        | YES        | -             | -         | -          |
|                       | <a href="#">LAN Bypass Gen3</a>              | YES        | YES        | -             | -         | -          |
|                       | <a href="#">Layer 2 Switching</a>            | YES        | -          | YES           | YES       | -          |
|                       | <a href="#">VLAN</a>                         | YES        | -          | YES           | YES       | YES        |

| Configuration Section                  | Function                               | EDR Series | EDF Series | OnCell Series | TN Series | NAT Series |
|--|--|------------|------------|---------------|-----------|------------|
|  | <a href="#">MAC Address Table</a>      | YES        | -          | YES           | YES       | YES        |
|  | <a href="#">QoS</a>                    | YES        | -          | -             | YES       | -          |
|  | <a href="#">Rate Limit</a>             | YES        | -          | -             | YES       | -          |
|  | <a href="#">Multicast</a>              | YES        | -          | YES           | YES       | -          |
|  | <a href="#">IGMP Snooping</a>          | YES        | -          | -             | YES       | -          |
|  | <a href="#">Static Multicast Table</a> | YES        | -          | YES           | YES       | -          |
|  | <a href="#">Network Interfaces</a>     | YES        | YES        | YES           | YES       | YES        |
| <b><a href="#">Redundancy</a></b>      |  | YES        | -          | -             | YES       | -          |
|  | <a href="#">Layer 2 Redundancy</a>     | YES        | -          | -             | -         | -          |
|  | <a href="#">Spanning Tree</a>          | YES        | -          | -             | YES       | -          |
|  | <a href="#">Turbo Ring V2</a>          | YES        | -          | -             | YES       | -          |
|  | <a href="#">Turbo Chain</a>            | YES        | -          | -             | -         | -          |
|  | <a href="#">Layer 3 Redundancy</a>     | YES        | -          | YES           | YES       | -          |
|  | <a href="#">VRRP</a>                   | YES        | -          | YES           | YES       | -          |
|  | <a href="#">WAN Redundancy</a>         | YES        | -          | YES           | YES       | -          |
| <b><a href="#">Network Service</a></b> |  | YES        | -          | YES           | YES       | YES        |
|  | <a href="#">DHCP Server</a>            | YES        | -          | YES           | YES       | YES        |
|  | <a href="#">Dynamic DNS</a>            | YES        | -          | YES           | YES       | -          |
|  | <a href="#">DNS Server</a>             | -          | -          | -             | YES       | -          |
| <b><a href="#">Routing</a></b>         |  | YES        | -          | YES           | YES       | YES        |
|  | <a href="#">Unicast Route</a>          | YES        | -          | YES           | YES       | YES        |
|  | <a href="#">Static Routes</a>          | YES        | -          | YES           | YES       | YES        |

| Configuration Section | Function                                   | EDR Series | EDF Series | OnCell Series | TN Series | NAT Series |
|-----------------------|--|------------|------------|---------------|-----------|------------|
|                       | <a href="#">RIP</a>                        | YES        | -          | -             | YES       | -          |
|                       | <a href="#">OSPF</a>                       | YES        | -          | -             | YES       | -          |
|                       | <a href="#">Routing Table</a>              | YES        | -          | YES           | YES       | YES        |
|                       | <a href="#">Multicast Route</a>            | YES        | -          | YES           | YES       | -          |
|                       | <a href="#">Multicast Route Settings</a>   | YES        | -          | YES           | YES       | -          |
|                       | <a href="#">Static Multicast Route</a>     | YES        | -          | YES           | YES       | -          |
|                       | <a href="#">Multicast Forwarding Table</a> | YES        | -          | YES           | YES       | -          |
|                       | <a href="#">Broadcast Forwarding</a>       | YES        | -          | YES           | YES       | -          |
|                       | <b><a href="#">NAT</a></b>                 | YES        | -          | YES           | YES       | YES        |
|                       | <b><a href="#">Object Management</a></b>   | YES        | YES        | YES           | YES       | -          |
|                       | <b><a href="#">Firewall</a></b>            | YES        | YES        | YES           | YES       | YES        |
|                       | <a href="#">Layer 2 Policy</a>             | YES        | YES        | YES           | YES       | -          |
|                       | <a href="#">Layer 3 Policy</a>             | -          | -          | -             | -         | YES        |
|                       | <a href="#">Layer 3-7 Policy</a>           | YES        | YES        | YES           | YES       | -          |
|                       | <a href="#">Device Lockdown</a>            | -          | -          | -             | -         | YES        |
|                       | <a href="#">Malformed Packets</a>          | YES        | YES        | YES           | YES       | -          |
|                       | <a href="#">Session Control</a>            | YES        | YES        | YES           | YES       | -          |
|                       | <a href="#">DoS Policy</a>                 | YES        | YES        | YES           | YES       | -          |
|                       | <a href="#">Soft Lockdown Mode</a>         | -          | -          | -             | YES       | -          |
|                       | <a href="#">Advanced Protection</a>        | YES        | YES        | YES           | YES       | -          |
|                       | <a href="#">Dashboard</a>                  | YES        | YES        | YES           | YES       | -          |

| Configuration Section                | Function                                    | EDR Series | EDF Series | OnCell Series | TN Series | NAT Series |
|--------------------------------------|---|------------|------------|---------------|-----------|------------|
|                                      | <a href="#">Configuration</a>               | YES        | YES        | YES           | YES       | -          |
|                                      | <a href="#">Protocol Filter Policy</a>      | YES        | YES        | YES           | YES       | -          |
|                                      | <a href="#">ADP</a>                         | YES        | YES        | YES           | YES       | -          |
|                                      | <a href="#">IPS</a>                         | YES        | YES        | -             | YES       | -          |
| <b><u>VPN</u></b>                    |   | YES        | -          | YES           | YES       | -          |
|                                      | <a href="#">IPSec</a>                       | YES        | -          | YES           | YES       | -          |
|                                      | <a href="#">L2TP Server</a>                 | YES        | -          | -             | YES       | -          |
|                                      | <a href="#">OpenVPN Client</a>              | YES        | -          | YES           | -         | -          |
| <b><u>Certificate Management</u></b> |   | YES        | YES        | YES           | YES       | YES        |
|                                      | <a href="#">Local Certificate</a>           | YES        | YES        | YES           | YES       | YES        |
|                                      | <a href="#">Trusted CA Certificate</a>      | YES        | YES        | YES           | YES       | YES        |
|                                      | <a href="#">Certificate Signing Request</a> | YES        | YES        | YES           | YES       | YES        |
| <b><u>Security</u></b>               |   | YES        | YES        | YES           | YES       | YES        |
|                                      | <a href="#">Device Security</a>             | YES        | YES        | YES           | YES       | YES        |
|                                      | <a href="#">Login Policy</a>                | YES        | YES        | YES           | YES       | YES        |
|                                      | <a href="#">Trusted Access</a>              | YES        | YES        | YES           | YES       | YES        |
|                                      | <a href="#">SSH &amp; SSL</a>               | YES        | YES        | YES           | YES       | YES        |
|                                      | <a href="#">Network Security</a>            | YES        | YES        | -             | YES       | -          |
|                                      | <a href="#">IEEE 802.1X</a>                 | YES        | -          | -             | YES       | -          |
|                                      | <a href="#">Authentication</a>              | YES        | YES        | YES           | YES       | YES        |
|                                      | <a href="#">Login Authentication</a>        | YES        | YES        | YES           | YES       | YES        |



| Configuration Section              | Function                                    | EDR Series | EDF Series | OnCell Series | TN Series | NAT Series |
|------------------------------------|---|------------|------------|---------------|-----------|------------|
|                                    | <a href="#">RADIUS</a>                      | YES        | YES        | YES           | YES       | YES        |
|                                    | <a href="#">TACACS+ Server</a>              | YES        | YES        | YES           | YES       | YES        |
|                                    | <a href="#">MXview Alert Notification</a>   | YES        | YES        | YES           | YES       | YES        |
| <b><a href="#">Diagnostics</a></b> |   | YES        | YES        | YES           | YES       | YES        |
|                                    | <a href="#">System Status</a>               | YES        | YES        | YES           | YES       | YES        |
|                                    | <a href="#">Utilization</a>                 | YES        | YES        | YES           | YES       | YES        |
|                                    | <a href="#">Fiber Check</a>                 | YES        | -          | -             | -         | -          |
|                                    | <a href="#">Network Status</a>              | YES        | YES        | YES           | YES       | YES        |
|                                    | <a href="#">Network Statistics</a>          | YES        | YES        | YES           | YES       | YES        |
|                                    | <a href="#">LLDP</a>                        | YES        | YES        | YES           | YES       | YES        |
|                                    | <a href="#">ARP Table</a>                   | YES        | YES        | YES           | YES       | YES        |
|                                    | <a href="#">Event Log and Notifications</a> | YES        | YES        | YES           | YES       | YES        |
|                                    | <a href="#">Event Log</a>                   | YES        | YES        | YES           | YES       | YES        |
|                                    | <a href="#">Event Notifications</a>         | YES        | YES        | YES           | YES       | YES        |
|                                    | <a href="#">Syslog</a>                      | YES        | YES        | YES           | YES       | YES        |
|                                    | <a href="#">SNMP Trap/Inform</a>            | YES        | YES        | YES           | YES       | YES        |
|                                    | <a href="#">Email Settings</a>              | YES        | YES        | YES           | -         | YES        |
|                                    | <a href="#">SMS Settings</a>                | -          | YES        | YES           | -         | -          |
|                                    | <a href="#">Tools</a>                       | YES        | YES        | YES           | YES       | -          |
|                                    | <a href="#">Port Mirroring</a>              | YES        | -          | -             | YES       | -          |
|                                    | <a href="#">Ping</a>                        | YES        | YES        | YES           | YES       | YES        |
|                                    | <a href="#">Diagnostic Support</a>          | -          | -          | YES           | -         | -          |

| Configuration Section                       | Function                                | EDR Series | EDF Series | OnCell Series | TN Series | NAT Series |
|---|---|------------|------------|---------------|-----------|------------|
| <b><u>Industrial Application</u></b>        | <a href="#">Netflow</a>                 | YES        | YES        | -             | -         | -          |
|   |   | -          | -          | -             | YES       | -          |
|   | <a href="#">IEC 61375</a>               | -          | -          | -             | YES       | -          |
|   | <a href="#">Ethernet Train Backbone</a> | -          | -          | -             | YES       | -          |
|   | <a href="#">TTDP Settings</a>           | -          | -          | -             | YES       | -          |
|   | <a href="#">Local ETBN Status</a>       | -          | -          | -             | YES       | -          |
|   | <a href="#">ETB Status</a>              | -          | -          | -             | YES       | -          |
|   | <a href="#">TCN Multicast Table</a>     | -          | -          | -             | YES       | -          |
|   | <a href="#">Communication Profile</a>   | -          | -          | -             | YES       | -          |
|   | <a href="#">ECSP Settings</a>           | -          | -          | -             | YES       | -          |
|   | <a href="#">SDTV2 Settings</a>          | -          | -          | -             | YES       | -          |
|   | <a href="#">ECSP Status</a>             | -          | -          | -             | YES       | -          |
|   | <a href="#">SDTV2 Status</a>            | -          | -          | -             | YES       | -          |
|   | <a href="#">Operational Status</a>      | -          | -          | -             | YES       | -          |
|   | <a href="#">Consist Info</a>            | -          | -          | -             | YES       | -          |
|   | <a href="#">Train Directory</a>         | -          | -          | -             | YES       | -          |
| <a href="#">Operational Train Directory</a> | -                                       | -          | -          | YES           | -         |            |
| <a href="#">TCN-URI Table</a>               | -                                       | -          | -          | YES           | -         |            |

# Document Conventions

This document uses the following formatting conventions:

| Convention/Format        | Description   |
|--------------------------|---|
| <b>Bold</b>              | Used for UI elements you see on-screen, including page name, tab name, field labels, dropdown options, menu path, etc.                          |
| <b>Italics</b>           | Used to highlight important information in a paragraph or a table, such as indicating that a UI setting is only shown under certain conditions. |
| <b>Code/commands/CLI</b> | Used for code snippets, blocks, commands, and CLI output.   |

## Chapter 2

---

# Quick Start

# Using a Web Browser to Configure the Industrial Secure Router

The device's web interface provides a convenient way to modify the router's configuration and access the built-in monitoring and network administration functions.

## Note

When using the device's web interface, we recommend using the following browsers and versions. Please note that Internet Explorer (IE) is not supported.

- Chrome: 2 most recent versions
- Firefox: Latest version and the Extended Support Release (ESR)
- Edge: 2 most recent major versions
- Safari: 2 most recent major versions
- iOS: 2 most recent major versions
- Android: 2 most recent major versions

Perform the following steps to access the device's web interface:

1. Make sure your PC host is connected to your device's LAN port, and is on the same subnet as your device.
2. Open a web browser and type the device's LAN IP address (**192.168.127.254** by default) into the address bar and press Enter.



3. The web login page will open. Enter the username (**admin** or **user**) and password (the same as the Console password) and click **LOG IN** to continue.

## Note

The default username is admin and the default password is moxa. We strongly recommend changing the password as soon as possible to ensure the security of your device.

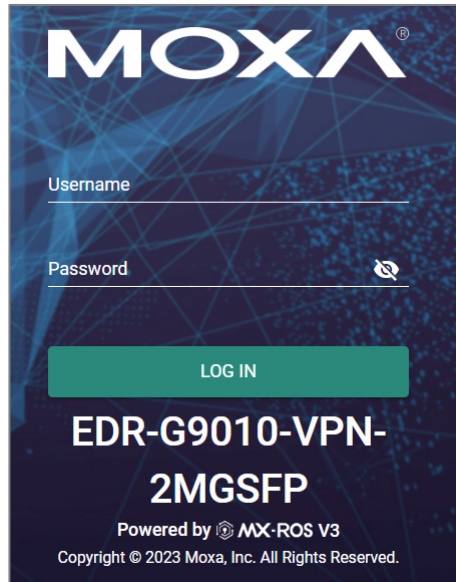

You may need to wait a few moments for the web interface to appear. If you have logged in before, a system message will appear showing the details of the last successful login. Click **CLOSE** to close this message.

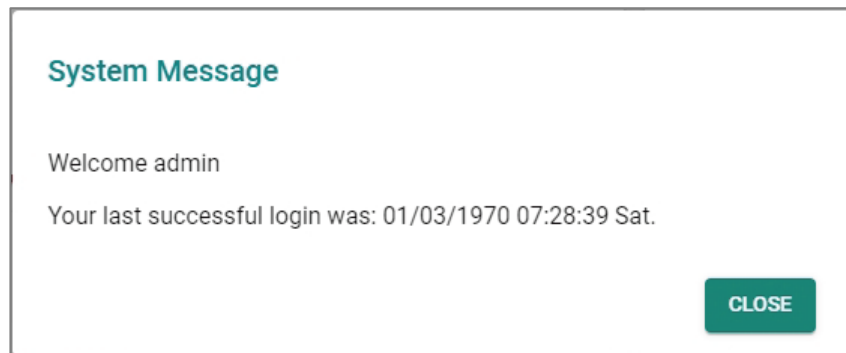

4. After successfully connecting to the router, the **Device Summary** screen will automatically appear. Use the menu tree on the left side of the window to open the function pages to access each of the router's functions.

MOXA EDR-G9010-VPN-2MGSPF Hi, admin

Search for a function

### Device Summary

**Model Information**

Product Model: EDR-G9010-VPN-2MGSPF  
 Name: Firewall/VPN Router 55149  
 Location: Device Location  
 LAN IP Address: 192.168.127.254  
 WAN IP Address: 0.0.0.0

MAC Address: 00:90:e8:91:86:72  
 Serial Number: TBZKB1155149  
 Firmware Version: V2.0 build 22070117  
 System Uptime: 0d1h19m38s

**Panel Status**

PWR1 PWR2 STATE MSTR/ H.TC CPLR/ LTC VPN VRRP/ HA USB

1 Link Up Ports  
9 Link Down Ports

EXPAND

**Event Summary (Last 3 days)**

|            |          |
|------------|----------|
| 0 Critical | 0 Error  |
| 0 Warning  | 0 Notice |

[View All Event Logs](#)

**CPU Usage History (%)** 2022/07/06 09:17:06

**Memory Usage History (%)** 2022/07/06 09:17:06

# Chapter 3

---

# UI Reference



# UI Reference Overview

This section provides you with a quick reference to the different settings and options of your device.

To help you understand how to use the user interface, the following sections are included:

- The MX-ROS User Interface
- Options Menu



The rest of this section follows the order of the menu areas in the user interface:

- Device Summary
- Setup Wizard
- System
- Cellular
- Serial
- Network Configuration
- Redundancy
- Network Service
- Routing
- NAT
- Object Management
- Firewall
- VPN
- Certificate Management
- Security
- Diagnostics
- Industrial Application

# The MX-ROS User Interface

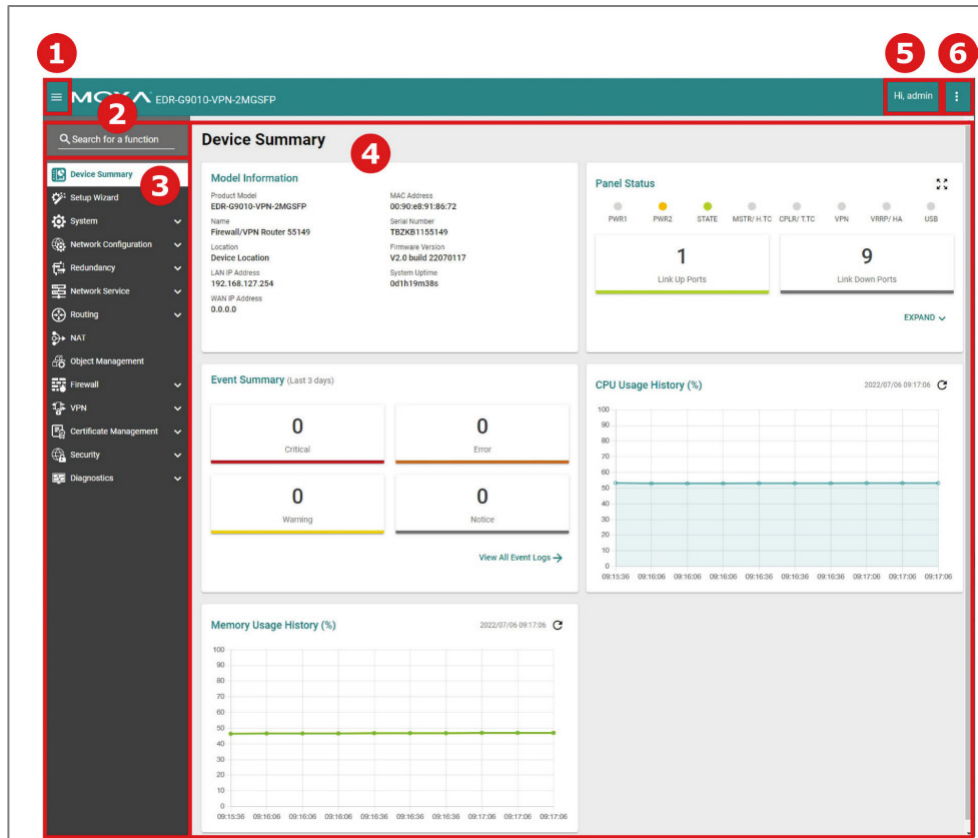
Here is an overview of the MX-ROS user interface.



1. Clicking  in the top-left will toggle display of the function menu.
2. Enter the name of a function in the **Search Bar** to quickly find a specific function page.
3. Click on a page name in the **Function Menu** on the left-hand side to go to its function page.
4. All the configuration options and information of the selected function page will be shown here.
5. The name of the currently logged-in user is shown here.
6. Clicking  in the top-right will expand the Options menu.

# Options Menu

Clicking the **Options** (  ) icon in the upper-right corner of the page will open the options menu.

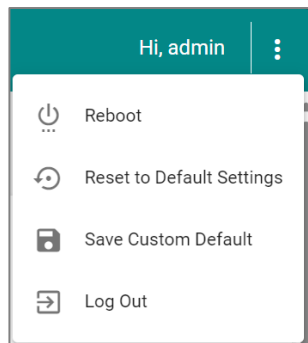

## Options Menu - User Privileges

Privileges to settings are granted to the different authority levels as follows. Refer to System > Account Management > User Accounts for more information on user accounts.

| Settings                         | Admin | Supervisor | User |
|----------------------------------|-------|------------|------|
| <b>Reboot</b>                    | R/W   | R/W        | -    |
| <b>Reset to Default Settings</b> | R/W   | -          | -    |
| <b>Save Custom Default</b>       | R/W   | -          | -    |
| <b>Log Out</b>                   | R/W   | R/W        | R/W  |

## Reboot

To manually reboot the device, click the **Options** (  ) icon in the upper-right corner of the page, and select **Reboot**.

## Reset to Default Settings

To reset the device to its default settings, click the **Options** (  ) icon in the upper-right corner of the page, and select **Reset to Default Settings**.

Select whether to reset to **Factory Default** settings, or the saved **Custom Default** settings, then click **APPLY**.

Refer to Save Custom Default for more information about custom default settings.

### **Note**

Custom Default is only available for the TN-4900 Series.

### **Warning**

When resetting your device to the factory default settings, all your current configuration settings will be permanently deleted.

Check the Keep certificate database and configuration option to keep the certificate database and configuration information. Leaving this option unchecked will delete all information on the device and reset everything to its factory default value.

## Save Custom Default

You can save a custom default configuration for your device. This allows you to reset the device to a trusted configuration without uploading a configuration file to restore from.

Refer to Reset to Default Settings for more information.

### **Note**

Save Custom Default is only available for the TN-4900 Series.

 **Note**

- Ensure that the current startup configuration works as expected and that the user account settings are correct before saving the configuration as a custom default.
- The configuration name can be modified on the Config Backup and Restore page. We recommend including the configuration name for better file differentiation. Please note that each configuration must be unique and not repetitive.
- Each device can only have one set of custom default settings.
- Custom default settings can only save and restore configuration settings. They do not include other uploaded files, such as SSL certificate files, SSH keys, etc.
- Refer to Configuration Types for more information about the different configurations your device uses.

To save the current startup configuration as a custom default, click the **Options ( ⋮ )** icon in the upper-right corner of the page, and select **Save Custom Default**.

## Log Out

To log out of the device, click the **Options ( ⋮ )** icon in the upper-right corner of the page, and select **Log Out**.

# Device Summary

## Menu Path: Device Summary

This page lets you see displays with information about your device and current status.

The screenshot displays the 'Device Summary' dashboard with the following sections:

- Model Information:** A table of device details.

|                           |                        |
|---------------------------|------------------------|
| Product Model             | MAC Address            |
| EDR-G9004-VPN-2MGTXSFP    | 00:90:e8:ee:ff:31      |
| System Name               | WAN 1 MAC Address      |
| Firewall/VPN Router 00000 | 00:90:E8:EE:FF:33      |
| Location                  | WAN 2 MAC Address      |
| Device Location           | 00:90:E8:EE:FF:32      |
| LAN IP Address            | Serial Number          |
| 192.168.127.94            | MOXAE8EEFF31           |
| WAN 1 IP Address          | Firmware Version       |
| 0.0.0.0                   | V3.10.0 build 24070315 |
| WAN 2 IP Address          | System Uptime          |
| 0.0.0.0                   | 0d20h50m13s            |
- Panel Status:** A row of status indicators for PWR1, PWR2, STATE, BP, WAN/DMZ, VPN, VRRP/HA, and USB. Below this are two large cards: '1 Link Up Ports' and '5 Link Down Ports'. An 'EXPAND' button is located at the bottom right of this section.
- System Event Summary (Last 3 days):** Four cards showing event counts: 0 Critical, 0 Error, 4 Warning, and 0 Notice. A 'View All System Event Logs' link is at the bottom.
- CPU Usage History (%):** A line graph showing CPU usage over time from 11:05:29 to 11:07:31. The usage is consistently near 0%.
- Memory Usage History (%):** A line graph showing memory usage over time from 11:05:29 to 11:07:31. The usage is consistently near 0%.

## Model Information

This display shows basic information about your device.

### Model Information

|                  |                           |                   |                        |
|------------------|---------------------------|-------------------|------------------------|
| Product Model    | EDR-G9004-VPN-2MGTXSFP    | MAC Address       | 00:90:e8:ee:ff:31      |
| System Name      | Firewall/VPN Router 00000 | WAN 1 MAC Address | 00:90:E8:EE:FF:33      |
| Location         | Device Location           | WAN 2 MAC Address | 00:90:E8:EE:FF:32      |
| LAN IP Address   | 192.168.127.94            | Serial Number     | MOXAE8EEFF31           |
| WAN 1 IP Address | 0.0.0.0                   | Firmware Version  | V3.10.0 build 24070315 |
| WAN 2 IP Address | 0.0.0.0                   | System Uptime     | 0d20h50m13s            |

| UI Setting              | Description   |
|-------------------------|---|
| <b>Product Model</b>    | Shows the product model of the device.  |
| <b>System Name</b>      | Shows the name of the device.<br>Refer to <a href="#">System &gt; System Management &gt; Information Settings</a> for more information.     |
| <b>Location</b>         | Shows the location of the device.<br>Refer to <a href="#">System &gt; System Management &gt; Information Settings</a> for more information. |
| <b>LAN IP Address</b>   | Shows the LAN IP address of the device. This can be configured in the <a href="#">Setup Wizard</a> .  |
| <b>WAN IP Address</b>   | Shows the WAN IP address of your device. This can be configured in the <a href="#">Setup Wizard</a> .                                       |
| <b>MAC Address</b>      | Shows the MAC address of your device.   |
| <b>Serial Number</b>    | Shows the serial number of your device.   |
| <b>Firmware Version</b> | Shows the firmware version of your device.  |
| <b>System Uptime</b>    | Shows the amount of time your device has been continuously running for.   |

## Panel Status

This display shows the status LEDs of your device. For example, connected ports will be shown in green, while disconnected ports will be shown in gray.

Click **EXPAND** to view more detailed information.

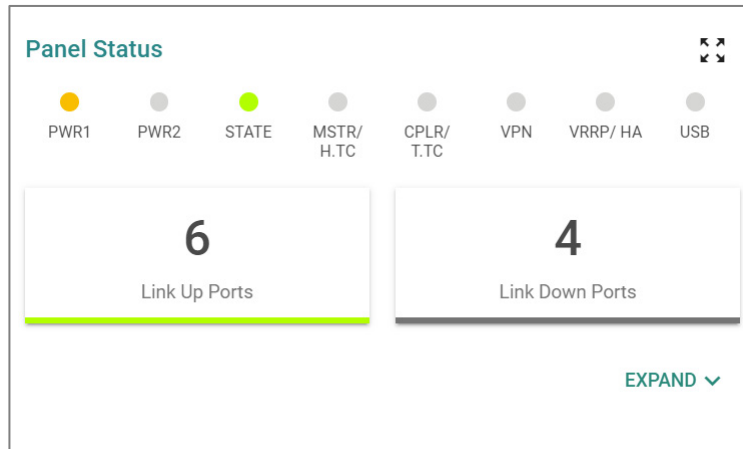

Click **COLLAPSE** to hide the details.

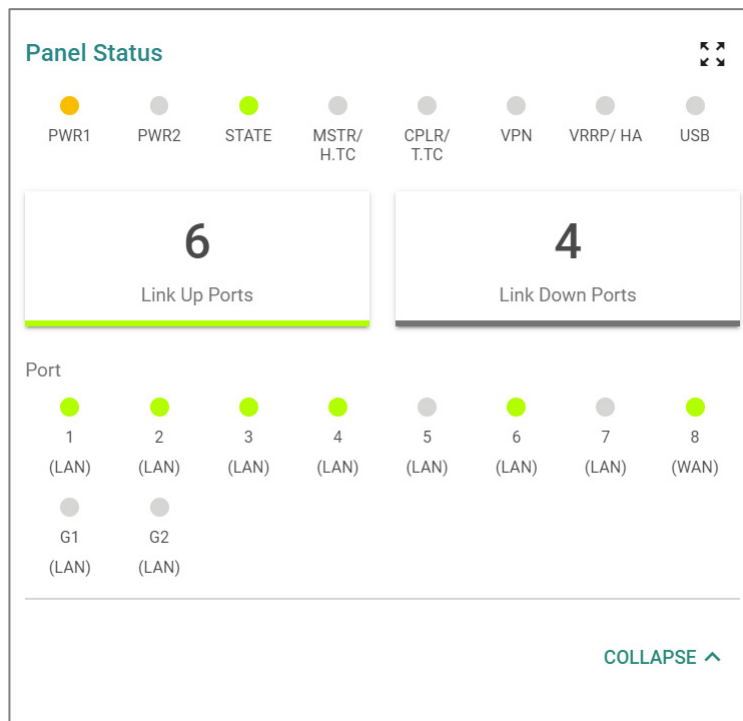

## Panel View

Clicking the **Expand** (🔍) icon in the **Panel Status** display will show your device's port status on a representative image of the device. This image will vary depending on your

device. Click the **Close** (✕) icon in the upper-right corner to close the **Panel View**.



**Note**

Available LEDs may vary across different versions of devices. For more information about status LEDs and their behavior, refer to LED Behavior.





## System Event Summary (Last 3 days)

This display shows the event summary for the past three days.

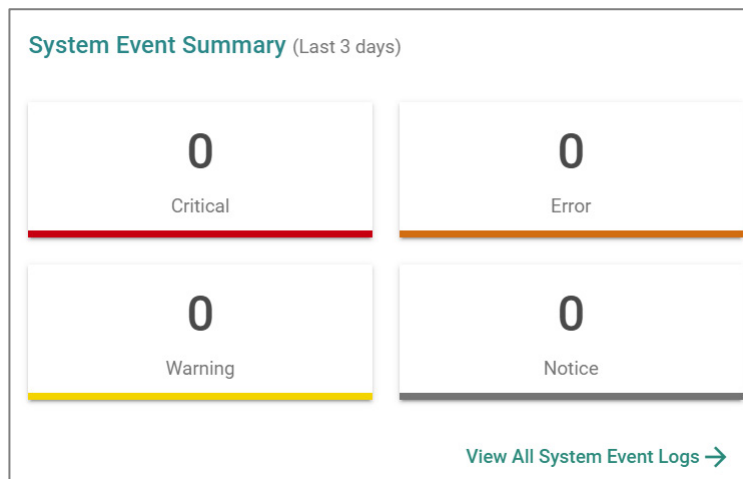

Click **View All System Event Logs** to go to the Event Log page to view event logs in more detail.

| Event Log  |                            |               |  |
|--|----------------------------|---------------|--|
| System Log   | Firewall Log               | VPN Log       | Settings and Backup  |
| <div style="display: flex; justify-content: space-between; align-items: center;"> <span>🔄 🗑️ 📄</span> <span>🔍 Search</span> </div> |                            |               |  |
| Index  | Timestamp                  | Severity      | Additional message   |
| 1  | 2023/8/11<br>18:40:4+8:00  | Informational | Auth Ok, Login Success via UI: Web. Account=admin, Bootup=71, Startup=2d3h41m38s             |
| 2  | 2023/8/11<br>18:26:7+8:00  | Informational | Logout via UI: Web. Account=admin, Bootup=71, Startup=2d3h27m42s                             |
| 3  | 2023/8/11<br>17:43:57+8:00 | Informational | Auth Ok, Login Success via UI: Web. Account=admin, Bootup=71, Startup=2d2h45m32s             |
| 4  | 2023/8/11<br>10:52:15+8:00 | Informational | Logout via UI: Serial Console. Account=admin, Bootup=71, Startup=1d19h53m50s                 |
| 5  | 2023/8/11<br>10:45:13+8:00 | Informational | Auth Ok, Login Success via UI: Serial Console. Account=admin, Bootup=71, Startup=1d19h46m48s |
| 6  | 2023/8/10<br>17:14:25+8:00 | Informational | Logout via UI: Web. Account=admin, Bootup=71, Startup=1d2h15m59s                             |
| 7  | 2023/8/10<br>17:5:43+8:00  | Informational | Auth Ok, Login Success via UI: Web. Account=admin, Bootup=71, Startup=1d2h7m18s              |

Refer to [Diagnostics > Event Logs and Notifications > Event Log](#) for more information.

## CPU Usage History (%)

This display shows the device's CPU usage. The data will be shown as a percentage over time. Click the **Refresh** (🔄) icon to refresh the graph.

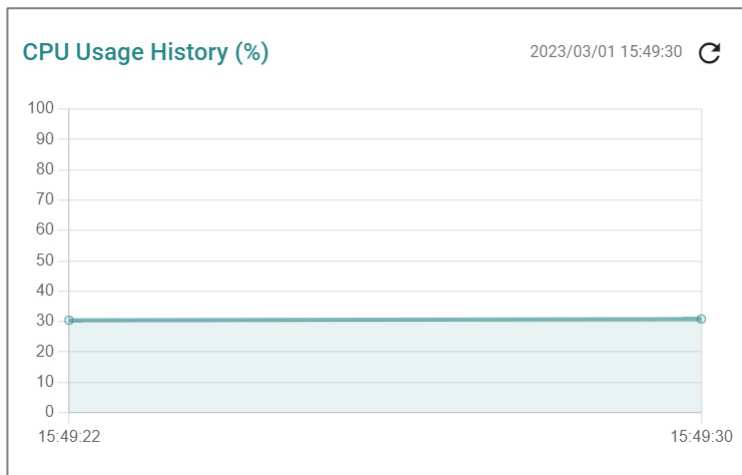

## Memory Usage History (%)

This display shows the device's memory usage. The data will be shown as a percentage over time. Click the **Refresh** (🔄) icon to refresh the graph.

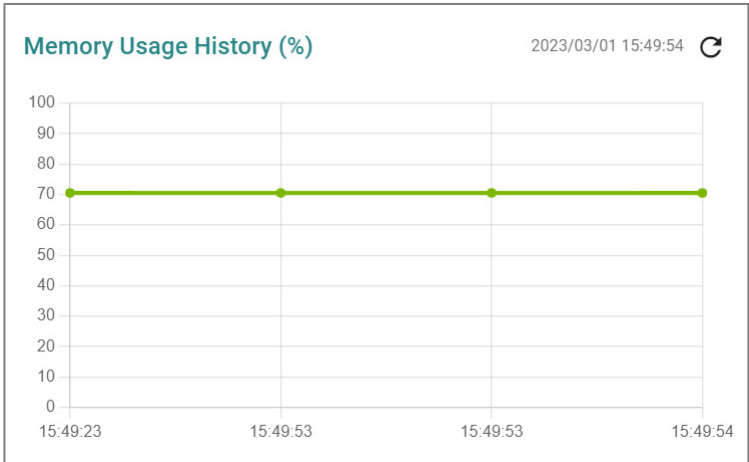

# Setup Wizard

## Menu Path: Setup Wizard

The Setup Wizard helps guide you through basic setup of your device through four steps:

1. Port Type
2. Interface
3. Service
4. Confirm

### Note

Available settings will vary depending on your product model.

## Port Type

In this step, you can set each port of your device to act as a LAN, WAN, or Bridge port.

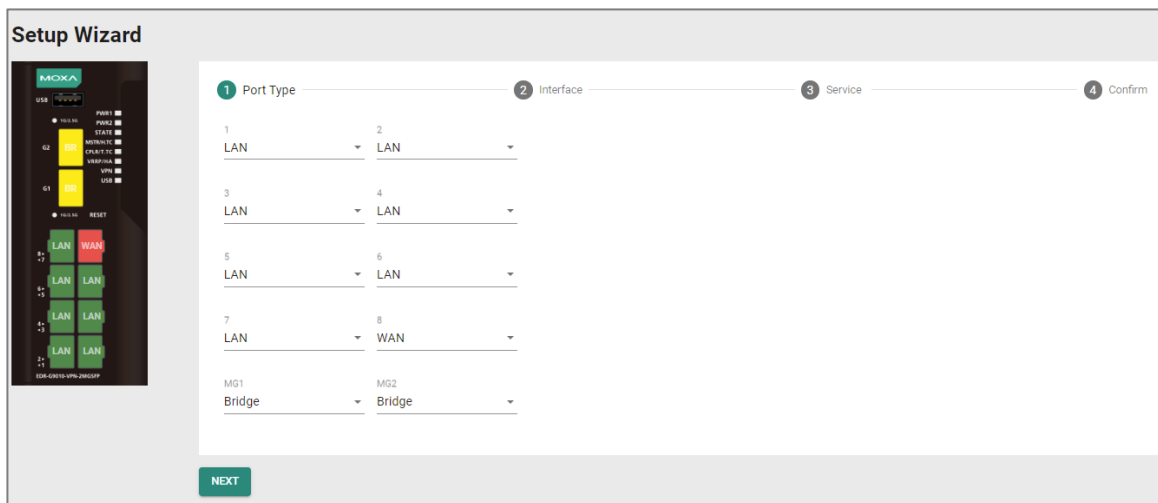

| UI Setting       | Description  | Valid Range        | Default Value |
|------------------|--|--------------------|---------------|
| <b>MG1 / MG2</b> | Select whether to use this fiber port as a LAN, WAN, or Bridge port. | LAN / WAN / Bridge | LAN           |

| UI Setting                    | Description   | Valid Range        | Default Value |
|-------------------------------|---|--------------------|---------------|
| 1 / 2 / 3 / 4 / 5 / 6 / 7 / 8 | Select whether to use this Ethernet port as a LAN, WAN, or Bridge port. | LAN / WAN / Bridge | LAN           |

## Interface

In this step, you can set up the connection interfaces for your device:

- LAN IP Configuration
- Bridge IP Configuration
- WAN Configuration

### Note

Some of these settings may not appear if there are no ports set to LAN, WAN, or Bridge.

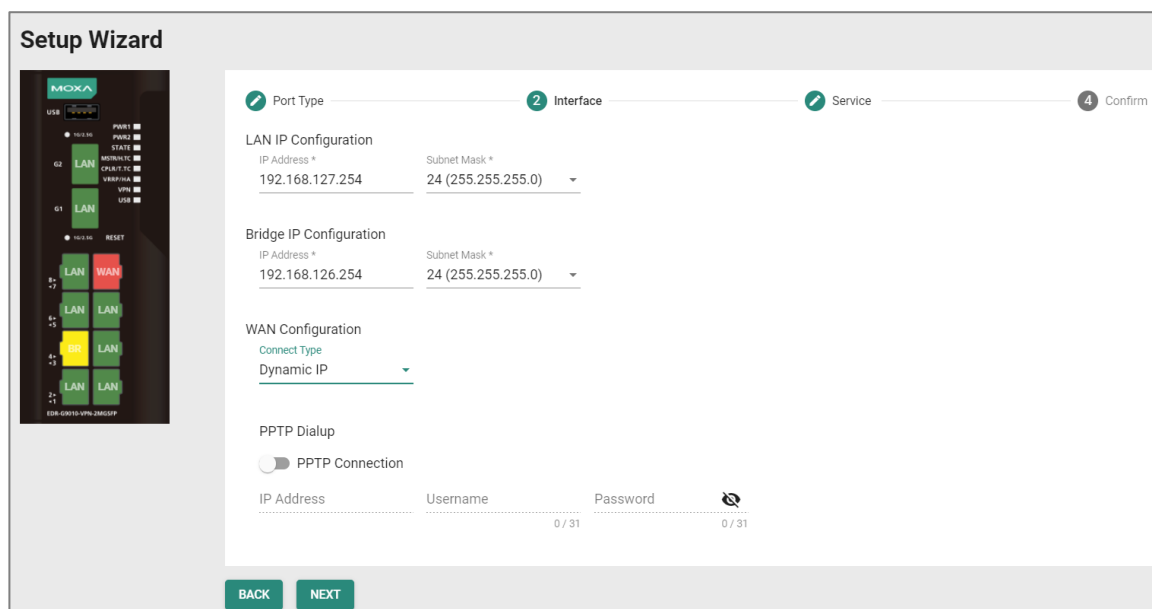

**Setup Wizard**

1 Port Type    2 **Interface**    3 Service    4 Confirm

**LAN IP Configuration**

IP Address \* 192.168.127.254    Subnet Mask \* 24 (255.255.255.0)

**Bridge IP Configuration**

IP Address \* 192.168.126.254    Subnet Mask \* 24 (255.255.255.0)

**WAN Configuration**

Connect Type  
Dynamic IP

**PPTP Dialup**

PPTP Connection

IP Address    Username    Password    

0 / 31    0 / 31

BACK    NEXT

## LAN IP Configuration

Set the LAN connection details for your device. If you're not familiar with your LAN interface, seek assistance from the network administrator. Network administrators usually determine the LAN interface configuration.

| UI Setting         | Description  | Valid Range       | Default Value   |
|--------------------|--|-------------------|-----------------|
| <b>IP Address</b>  | Specify the IP address for your LAN port.<br><div style="border: 1px solid #ccc; background-color: #f9f9f9; padding: 5px; margin-top: 10px;"><p> <b>Note</b><br/>The IP Address should be inputted as unicast IP address.</p></div> | Valid IP address  | 192.168.127.245 |
| <b>Subnet Mask</b> | Specify the subnet mask for your LAN port.   | Valid subnet mask | 255.255.255.0   |

## WAN IP Configuration

Set the WAN connection details for your device. If you're not familiar with your WAN interface, seek assistance from the network administrator. Network administrators usually determine the WAN interface configuration.

| UI Setting          | Description  | Valid Range                    | Default Value |
|---------------------|--|--------------------------------|---------------|
| <b>Connect Type</b> | Select the connection type to use for your WAN port. | Dynamic IP / Static IP / PPPoE | Dynamic IP    |

If you choose **Static IP** as your **Connection Type**, these settings will also appear:

| UI Setting         | Description                                | Valid Range       | Default Value |
|--------------------|--|-------------------|---------------|
| <b>IP Address</b>  | Specify the IP address for your WAN port.  | Valid IP address  | N/A           |
| <b>Gateway</b>     | Specify the gateway for your WAN port.     | Valid IP address  | N/A           |
| <b>Subnet Mask</b> | Specify the subnet mask for your WAN port. | Valid subnet mask | N/A           |

## PPTP Dialup

Set the PPTP Dialup connection details for your device. This section only appears if **Static IP** or **Dynamic IP** is set for **WAN Configuration > Connect Type**.

### **Note**

Availability of this feature may vary depending on your product model and version.

| UI Setting             | Description                                     | Valid Range        | Default Value |
|------------------------|---|--------------------|---------------|
| <b>PPTP Connection</b> | Enable or disable using a PPTP connection.      | Enabled / Disabled | Disabled      |
| <b>IP Address</b>      | Specify the IP address of your PPTP connection. | Valid IP address   | N/A           |
| <b>Username</b>        | Specify the username for your PPTP connection.  | 1 to 31 characters | N/A           |
| <b>Password</b>        | Specify the password for your PPTP connection.  | 1 to 31 characters | N/A           |

## PPPoE Dialup

Set the PPPoE Dialup connection details for your device. This section only appears if **PPPoE** is set for **WAN Configuration > Connect Type**.

| UI Setting       | Description                                      | Valid Range        | Default Value |
|------------------|--|--------------------|---------------|
| <b>Username</b>  | Specify the username for your PPPoE connection.  | 1 to 31 characters | N/A           |
| <b>Password</b>  | Specify the password for your PPTP connection.   | 1 to 31 characters | N/A           |
| <b>Host Name</b> | Specify the host name for your PPPoE connection. | 1 to 31 characters | N/A           |

## Service

In this step, you can enable or disable services for your device.

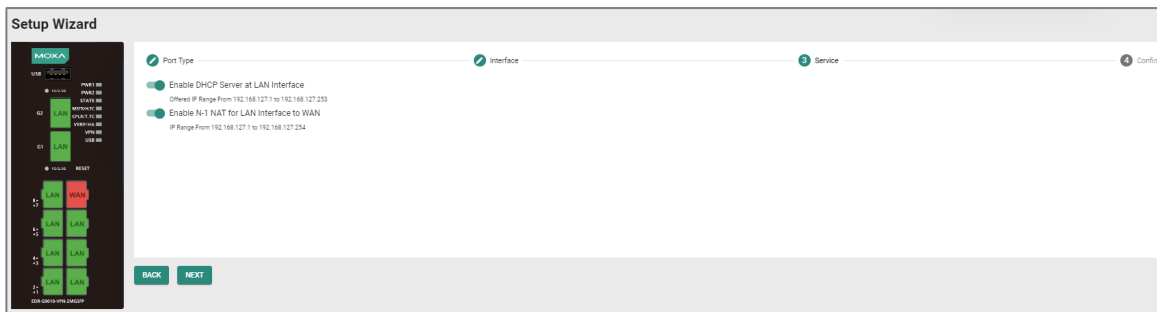



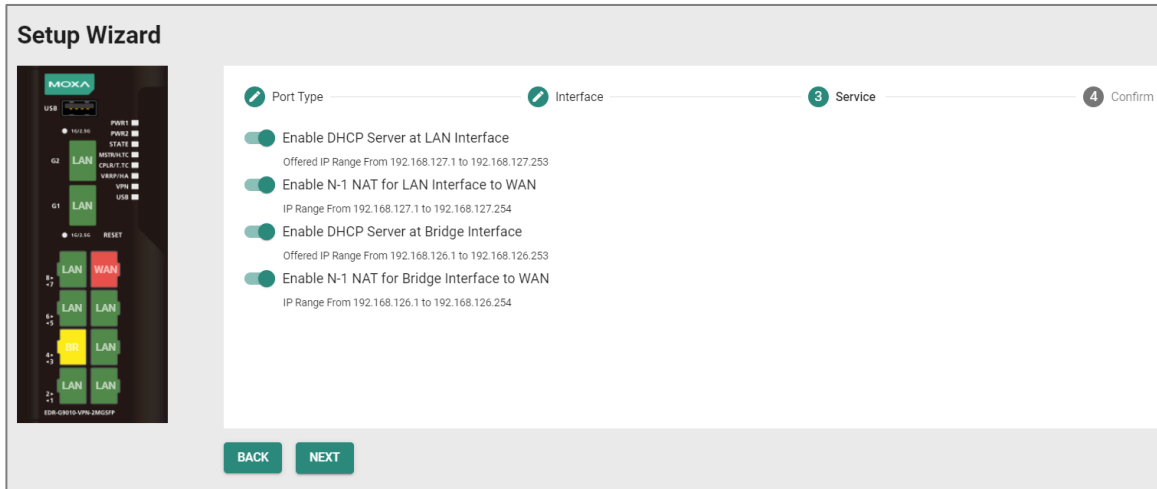

| UI Setting   | Description   | Valid Range        | Default Value |
|--|---|--------------------|---------------|
| <b>Enable DHCP Server at LAN Interface</b>   | Enable or disable using a DHCP server for the LAN interface.  | Enabled / Disabled | Enabled       |
| <b>Enable N-1 NAT for LAN Interface to WAN</b>                                       | Enable or disable using N-1 NAT for LAN interfaces to WAN.    | Enabled / Disabled | Enabled       |
| <b>Enable DHCP Server at Bridge Interface</b><br><b>(if Bridge Mode is Port)</b>     | Enable or disable using a DHCP server for bridge interfaces.  | Enabled / Disabled | Enabled       |
| <b>Enable N-1 NAT for Bridge Interface to WAN</b><br><b>(if Bridge Mode is Port)</b> | Enable or disable using N-1 NAT for bridge interfaces to WAN. | Enabled / Disabled | Enabled       |

## Confirm

Confirm your settings, then click **APPLY** to save and apply your changes.

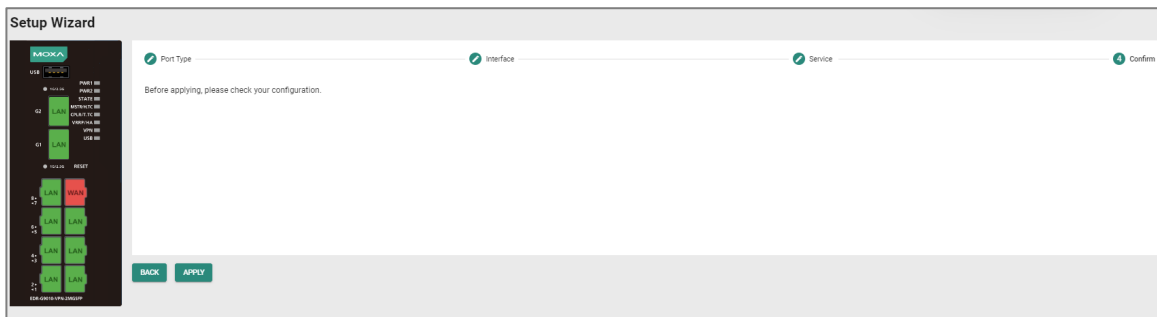

# System

## Menu Path: System

The System settings area lets you configure the main system settings for your device.

This settings area includes these sections:

- System Management
- Account Management
- License Management
- Management Interface
- Time
- Power Management
- SMS
- GNSS
- Setting Check

## System - User Privileges

Privileges to System settings are granted to the different authority levels as follows.

Refer to [System > Account Management > User Accounts](#) for more information on user accounts.

| Settings                                | Admin | Supervisor | User |
|---|-------|------------|------|
| <b>System Management</b>                |       |            |      |
| <b>Information Settings</b>             | R/W   | R/W        | R    |
| <b>Firmware Upgrade</b>                 | R/W   | -          | -    |
| <b>Software Package Management</b>      | R/W   | -          | -    |
| <b>Configuration Backup and Restore</b> | R/W   | -          | -    |
| <b>Account Management</b>               |       |            |      |

| Settings                      | Admin | Supervisor | User |
|-------------------------------|-------|------------|------|
| <b>User Account</b>           | R/W   | -          | -    |
| <b>Password Policy</b>        | R/W   | -          | -    |
| <b>License Management</b>     | R/W   | R          | R    |
| <b>Management Interface</b>   |       |            |      |
| <b>Out of Band Management</b> | R/W   | R/W        | R    |
| <b>User Interface</b>         | R/W   | R/W        | R    |
| <b>Hardware Interface</b>     | R/W   | R/W        | R    |
| <b>SNMP</b>                   | R/W   | -          | -    |
| <b>Moxa Remote Connect</b>    | R/W   | -          | -    |
| <b>MXsecurity</b>             | R/W   | R/W        | -    |
| <b>Time</b>                   |       |            |      |
| <b>System Time</b>            | R/W   | R/W        | R    |
| <b>NTP/SNTP Server</b>        | R/W   | R/W        | R    |
| <b>Power Management</b>       | R/W   | R/W        | R    |
| <b>SMS</b>                    | R/W   | R/W        | R    |
| <b>GNSS</b>                   | R/W   | R/W        | R    |
| <b>Setting Check</b>          | R/W   | R/W        | R    |

## System Management

### Menu Path: System > System Management

This section lets you manage your device's identification, firmware, and configuration backup settings.

This section includes these pages:

- Information Settings
- Firmware Upgrade
- Software Package Management
- Configuration Backup and Restore

## Information Settings

**Menu Path:** System > System Management > Information Settings

This page lets you add additional information about the device to make it easier to identify on the network.

### Information Settings

Device Name 0 / 30

---

Location 0 / 80

---

Description 0 / 40

---

Contact Information 0 / 40

---

APPLY

| UI Setting         | Description                         | Valid Range        | Default Value   |
|--------------------|-------------------------------------|--------------------|---|
| <b>Device Name</b> | Enter a name for the device.        | 1 to 30 characters | Firewall/VPN Router-xxxxx<br>(where xxxxx is the last 5 characters of the device's serial number) |
| <b>Location</b>    | Enter a location for the device.    | 1 to 80 characters | Device Location   |
| <b>Description</b> | Enter a description for the device. | 1 to 40 characters | N/A   |

| UI Setting                 | Description  | Valid Range        | Default Value |
|----------------------------|--|--------------------|---------------|
| <b>Contact Information</b> | Enter the contact information of the person in charge of the device. | 1 to 40 characters | N/A           |

## Firmware Upgrade

**Menu Path:** [System](#) > [System Management](#) > [Firmware Upgrade](#)

This page lets you upgrade the firmware of your device.

You can upgrade the firmware through the following methods:

- Local
- TFTP
- USB
- SCP
- SFTP
- Moxa service (refer to the MXview One Series User Manual)

### Note

As of v3.12, the device will retain all configuration settings when upgrading to newer firmware.

However, as a precaution, we still recommend backing up your configuration before upgrading firmware. Refer to [System > System Management > Configuration Backup and Restore](#) for more information.

### Note

If it is necessary to verify the integrity and signature of the application when the system is running, the administrator can use the show integrity check CLI command.

The device provides specific CLI commands that allow authenticated users to access the CLI interface through SSH at any time and execute commands to obtain the integrity status of the commands and configurations stored on the device. Therefore, it is recommended that system administrators design scripts or programs to connect to the device via SSH regularly.

Users can integrate these CLI commands into system-level scripts for automation or manually verify whether the internal commands and configurations of the device have been modified without authorization.

### ▲ Warning

Upgrading the firmware should be only be done by qualified personnel, as it is possible to render the device inoperable if the upgrade is not done properly. If you are not familiar with the process, please request the assistance of qualified personnel. You can also consult with Moxa support and we will provide you with the necessary assistance.

Before performing a firmware upgrade, make sure you take the following precautions:

- Back up your configuration before upgrading the firmware
- Ensure that the device has power during the entire process
- Ensure that your computer stays connected to the device you are upgrading the firmware on
- Make sure the connection to the firmware source is not interrupted during the upgrade process

## Local

If you select **Local** as your **Method**, these settings will appear. The Local method lets you upload firmware directly from local storage on the host device.

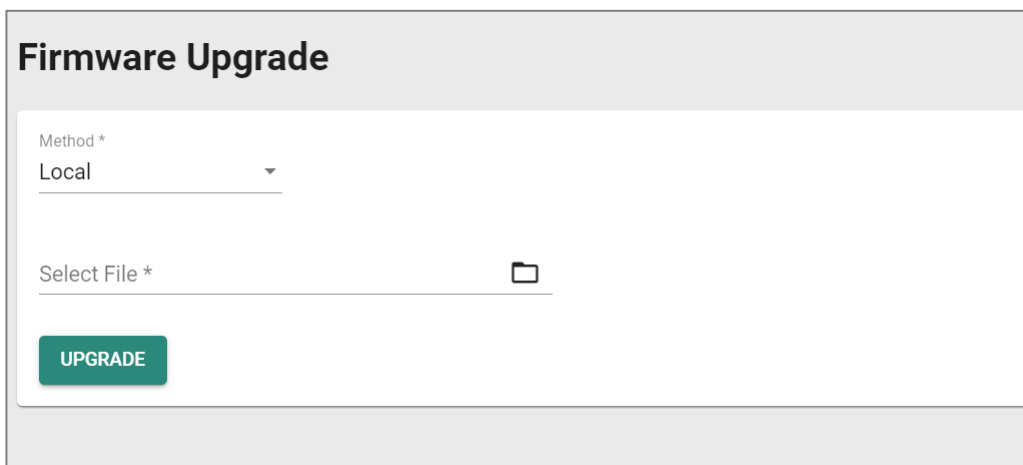

The screenshot shows a web interface titled "Firmware Upgrade". It features a dropdown menu labeled "Method \*" with "Local" selected. Below this is a "Select File \*" field with a folder icon, and a green "UPGRADE" button.

| UI Setting  | Description  | Valid Range | Default Value |
|-------------|--|-------------|---------------|
| Select File | Navigate to and upload the firmware file from the local host device. | N/A         | N/A           |

## TFTP

If you select **TFTP** as your **Method**, these settings will appear. The TFTP method lets you upload and install firmware stored on a remote TFTP server.

## Firmware Upgrade

Method  
TFTP

Server IP Address \*      File Name \*

UPGRADE

| UI Setting               | Description                                | Valid Range | Default Value |
|--------------------------|--|-------------|---------------|
| <b>Server IP Address</b> | Specify the IP address of the TFTP server. | IP address  | N/A           |
| <b>File Name</b>         | Specify the filename of the firmware file. | File name   | N/A           |

## USB

If you select **USB** as your **Method**, these settings will appear. The USB method allows you to install firmware directly from a USB drive attached to your device.

 **Note**

This feature requires USB Function to be enabled in System > Management Interface > Hardware Interface.

## Firmware Upgrade

Method \*  
USB

Select File \* 

**UPGRADE**

| UI Setting         | Description                                 | Valid Range | Default Value |
|--------------------|---|-------------|---------------|
| <b>Select File</b> | Select the firmware file on the USB device. | N/A         | N/A           |

## SCP

If you select **SCP** as your **Method**, these settings will appear. The SCP (secure copy protocol) method lets you upload and install firmware from a remote system.

## Firmware Upgrade

Method \*  
SCP

Account \* Password \*   
0 / 31 0 / 31

Server IP Address \* File Name \* 0 / 63  
0 / 31

**UPGRADE**

| UI Setting               | Description                                  | Valid Range        | Default Value |
|--------------------------|--|--------------------|---------------|
| <b>Account</b>           | Enter the remote system account name.        | 1 to 31 characters | N/A           |
| <b>Password</b>          | Enter the remote system account password.    | 1 to 31 characters | N/A           |
| <b>Server IP Address</b> | Specify the IP address of the remote system. | IP address         | N/A           |



| UI Setting       | Description                                | Valid Range        | Default Value |
|------------------|--|--------------------|---------------|
| <b>File Name</b> | Specify the filename of the firmware file. | 1 to 63 characters | N/A           |

## SFTP

If you select **SFTP** as your **Method**, these settings will appear. The SFTP method lets you upload and install firmware stored on a remote SFTP server.

The screenshot shows a 'Firmware Upgrade' form. At the top, 'Method' is set to 'SFTP'. Below this are four input fields: 'Account \*' (0/31), 'Password \*' (0/31) with a toggle icon, 'Server IP Address \*' (0/31), and 'File Name \*' (0/63). A green 'UPGRADE' button is located at the bottom left of the form.

| UI Setting               | Description                                | Valid Range        | Default Value |
|--------------------------|--|--------------------|---------------|
| <b>Account</b>           | Enter the SFTP server account name.        | 1 to 31 characters | N/A           |
| <b>Password</b>          | Enter the SFTP server account password.    | 1 to 31 characters | N/A           |
| <b>Server IP Address</b> | Specify the IP address of the SFTP server. | IP address         | N/A           |
| <b>File Name</b>         | Specify the filename of the firmware file. | 1 to 63 characters | N/A           |

## Software Package Management

**Menu Path: System > System Management > Software Package Management**

This page lets you upgrade your Network Security Package and MXsecurity Agent Package, enhancing your device's security capabilities. To upgrade a software package, you can either use the package included with the currently installed firmware, or you can download the latest version from the resource section on the Moxa website at [www.moxa.com](http://www.moxa.com).

**Note**

Keeping your software packages updated is critical to keep your device and network secure against the latest cyberattacks.

- **Network Security Package:** Helps you protect your device and network with IPS (Intrusion Prevention System) patterns and a DPI (Deep Packet Inspection) engine.

**Note**

Products that do not support a firewall will not be compatible with the Network Security Package. Most Moxa routers support firewall functionality, except for products with model names that include '-ETBN-' but do not include '-F-', such as the TN-4908-ETBN-4GTX-4GTXBP-WV-CT-T.

- **MXsecurity Agent Package:** Provides centralized visibility and security management to streamline management of your device. It helps you monitor and identify cyberthreats, and also helps prevent security misconfigurations to create a robust threat defense.

## Network Security Package

Network Security Package

Status  
Enabled

Source \*

UPGRADE

| UI Setting    | Description   | Valid Range      | Default Value |
|---------------|---|------------------|---------------|
| <b>Source</b> | Select a source to use to upgrade the software package.<br><b>Local:</b> Use a file stored on the local host.<br><b>Firmware:</b> Use the package included with the current firmware. | Local / Firmware | N/A           |

| UI Setting   | Description   | Valid Range | Default Value           |
|--|---|-------------|-------------------------|
| <b>Select File (if Local is set for Source)</b>        | <p>Select network security package downloaded from Moxa's website.</p> <p>Moxa will periodically release new security packages on the Moxa official website. Users can download the latest security package and then import it into their device.</p> | N/A         | N/A                     |
| <b>Package Version (if Firmware is set for Source)</b> | Shows the included package version of the current firmware.   | N/A         | Current Package Version |

## MXsecurity Agent Package

**MXsecurity Agent Package**

Status  
Enabled

Source \*

**UPGRADE**

| UI Setting                                     | Description   | Valid Range      | Default Value           |
|--|---|------------------|-------------------------|
| <b>Source</b>                                  | <p>Select a source to use to upgrade the software package.</p> <p><b>Local:</b> Use a file stored on the local host.</p> <div style="background-color: #f0f0f0; padding: 10px; margin: 10px 0;"> <p><b>Note</b></p> <p>The <b>Local</b> option is not commonly used in standard environments. However, if you experience issues with your device and MXsecurity, please reach out to Moxa Technical Support. They can utilize the <b>Local</b> option as a troubleshooting interface.</p> </div> <p><b>Firmware:</b> Use the package included with the current firmware.</p> <div style="background-color: #f0f0f0; padding: 10px; margin: 10px 0;"> <p><b>Note</b></p> <p>Starting from v3.10, the MXsecurity Agent Package will be automatically upgraded when the firmware is upgraded. When upgraded, a "Successfully installed MXSecurity agent package" notification will appear when logging in, and a notification can be found in the <b>Event Log &gt; System Log</b>.</p> </div> | Local / Firmware | N/A                     |
| <b>Select File (if Source is Local)</b>        | This is a troubleshooting interface in case you encounter issues with your device and MXsecurity.   | N/A              | N/A                     |
| <b>Package Version (if Source is Firmware)</b> | This shows the included package version of the current firmware.  | N/A              | Current Package Version |

## Configuration Backup and Restore

**Menu Path:** [System > System Management > Configuration Backup and Restore](#)

This page helps you back up and restore your device configuration.

This page includes these tabs:

- Backup
- Restore
- File Encryption

 **Note**

For the TN-4900 Series, configuration files from firmware version v1.2 are not compatible with firmware v3.0 and higher due to substantial changes made between v1.2 and v3.0. Please create and import a new configuration file when changing from firmware v1.2 to v3.0 or higher. If you encounter any issues, please contact Moxa technical support.

## Configuration Backup and Restore - Backup

### Menu Path: System > System Management > Configuration Backup and Restore - Backup

This page lets you create a backup of the current device configuration.

There are multiple methods of backing up the device configuration:

- Local
- TFTP
- USB
- SCP
- SFTP

 **Note**

For security reasons, we strongly recommend that you back up the system configuration to a secure storage location periodically.

### Local

If you select **Local** as your **Method**, these settings will appear. The Local method will export the configuration backup file to the local host.

## Configuration Backup and Restore

Backup
Restore
File Encryption

Method \*

Local ▼

BACK UP

### TFTP

If you select **TFTP** as your **Method**, these settings will appear. The TFTP method lets you upload the configuration backup file to a remote TFTP server.

## Configuration Backup and Restore

Backup
Restore
File Encryption

Method \*

TFTP ▼

Server IP Address \* File Name \*

BACK UP

| UI Setting               | Description   | Valid Range        | Default Value |
|--------------------------|---|--------------------|---------------|
| <b>Server IP Address</b> | Specify the IP address of the TFTP server.              | Valid IP address   | N/A           |
| <b>File Name</b>         | Specify the file name of the configuration backup file. | 1 to 63 characters | N/A           |

## USB

If you select **USB** as your **Method**, these settings will appear. The USB method allows you to export the configuration backup file to a USB drive connected to the device. You can also enable automatic backups, which will export a configuration file to a USB drive whenever the configuration is changed.

### **Note**

This feature requires USB Function to be enabled in System > Management Interface > Hardware Interface.

## Configuration Backup and Restore

Backup Restore File Encryption

Method \*

USB

**BACK UP**

### Auto Backup of Configurations

Automatically Back Up \*

Enabled

**APPLY**

| UI Setting                   | Description                          | Valid Range        | Default Value |
|------------------------------|--------------------------------------|--------------------|---------------|
| <b>Automatically Back Up</b> | Enable or disable automatic backups. | Enabled / Disabled | Disabled      |

## SCP

If you select **SCP** as your **Method**, these settings will appear. The SCP (secure copy protocol) method lets you upload the configuration backup file to a remote system.

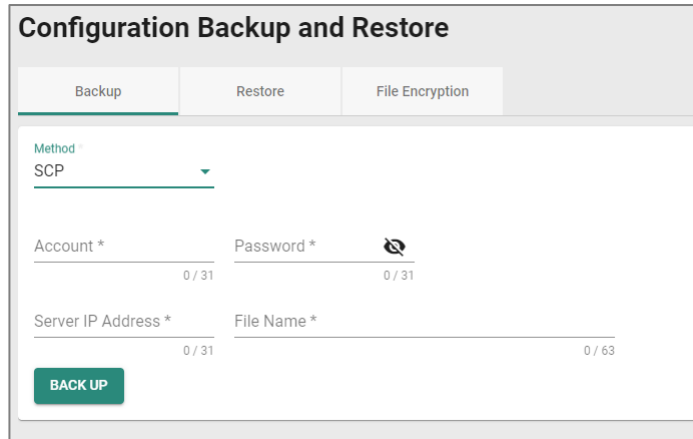

The screenshot shows a web interface titled "Configuration Backup and Restore". It has three tabs: "Backup", "Restore", and "File Encryption". The "Backup" tab is active. Under the "Method" dropdown, "SCP" is selected. Below this, there are four input fields: "Account \*" (0/31), "Password \*" (0/31) with a toggle for visibility, "Server IP Address \*" (0/31), and "File Name \*" (0/63). A green "BACK UP" button is located at the bottom left of the form.

| UI Setting               | Description   | Valid Range        | Default Value |
|--------------------------|---|--------------------|---------------|
| <b>Account</b>           | Enter the remote system account name.                   | 1 to 31 characters | N/A           |
| <b>Password</b>          | Enter the remote system account password.               | 1 to 31 characters | N/A           |
| <b>Server IP Address</b> | Specify the IP address of the remote system.            | Valid IP address   | N/A           |
| <b>File Name</b>         | Specify the file name of the configuration backup file. | 1 to 63 characters | N/A           |

## SFTP

If you select **SFTP** as your **Method**, these settings will appear. The SFTP method lets you upload the configuration backup file to a remote SFTP server.



| UI Setting               | Description   | Valid Range        | Default Value |
|--------------------------|---|--------------------|---------------|
| <b>Account</b>           | Enter the SFTP server account name.                     | 1 to 31 characters | N/A           |
| <b>Password</b>          | Enter the SFTP server account password.                 | 1 to 31 characters | N/A           |
| <b>Server IP Address</b> | Specify the IP address of the SFTP server.              | Valid IP address   | N/A           |
| <b>File Name</b>         | Specify the file name of the configuration backup file. | 1 to 63 characters | N/A           |

## Configuration Backup and Restore - Restore

### Menu Path: System > System Management > Configuration Backup and Restore - Restore

This page lets you restore a previously backed up configuration.

There are multiple methods of restoring the device configuration:

- Local
- TFTP
- USB
- SCP
- SFTP

## Local

If you select **Local** as your **Method**, these settings will appear. The Local method will restore from a configuration file on the local host.

The screenshot shows the 'Configuration Backup and Restore' interface. It has three tabs: 'Backup', 'Restore', and 'File Encryption'. The 'Restore' tab is active. Under the heading 'Configuration Firmware Version Checking', there is a 'Status \*' dropdown menu set to 'Enabled' and an 'APPLY' button. Below this, there is a 'Method' dropdown menu set to 'Local' and a 'Select File \*' field with a folder icon. A 'RESTORE' button is located at the bottom of the form.

| UI Setting         | Description   | Valid Range        | Default Value |
|--------------------|---|--------------------|---------------|
| <b>Status</b>      | Enable or disable configuration file firmware version checking. This checks to make sure the configuration file is for the current firmware version or earlier. | Enabled / Disabled | Disabled      |
| <b>Select File</b> | Select the configuration file to restore from.  | N/A                | N/A           |

## TFTP Server

If you select **TFTP** as your **Method**, these settings will appear. The TFTP method lets you restore from a configuration file on a remote TFTP server.

### Configuration Backup and Restore

Backup
Restore
File Encryption

**Configuration Firmware Version Checking**

Status \*

**APPLY**

Method

Server IP Address \*  0 / 31      File Name \*  0 / 63

**RESTORE**

| UI Setting               | Description   | Valid Range        | Default Value |
|--------------------------|---|--------------------|---------------|
| <b>Status</b>            | Enable or disable configuration file firmware version checking. This checks to make sure the configuration file is for the current firmware version or earlier. | Enabled / Disabled | Disabled      |
| <b>Server IP Address</b> | Specify the IP address of the TFTP server.  | Valid IP address   | N/A           |
| <b>File Name</b>         | Specify the file name of the configuration file to restore from.  | N/A                | N/A           |

## USB

If you select **USB** as your **Method**, these settings will appear. The USB method allows you to restore from a configuration file on a USB drive connected to the device.

### Note

This feature requires USB Function to be enabled in System > Management Interface > Hardware Interface.

## Configuration Backup and Restore

Backup
Restore
File Encryption

### Configuration Firmware Version Checking

Status \*  
Enabled ▼

APPLY

### Method

Method \*  
USB ▼

Select File \* 📁

RESTORE

### Auto Configuration Restore

Automatically Restore \*  
Disabled ▼

APPLY

| UI Setting         | Description  | Valid Range        | Default Value |
|--------------------|--|--------------------|---------------|
| <b>Status</b>      | Enable or disable configuration file firmware version checking. This checks to make sure the configuration file is for the current firmware version or earlier. <div style="background-color: #f0f0f0; padding: 10px; margin-top: 10px;"> <p><b>Note</b></p> <p>If the configuration file does not have a version header, it will still be considered to be a valid file to restore from.</p> </div> | Enabled / Disabled | Disabled      |
| <b>Select File</b> | Select the configuration file to restore from.   | N/A                | N/A           |

| UI Setting                                      | Description   | Valid Range        | Default Value |
|---|---|--------------------|---------------|
| <b>Automatically Restore (If Method is USB)</b> | <p>Enable or disable auto restore of the device configuration. If this function is enabled, the device will automatically restore its configuration from an inserted ABC-02 whenever the device is booted.</p> <div style="border: 1px solid #ccc; padding: 10px; background-color: #f9f9f9;"> <p><b>Note</b></p> <p>The auto-restore feature will look for configuration files on an inserted ABC-02 in the following order:</p> <ol style="list-style-type: none"> <li>1. An .ini configuration file named with the device's MAC address</li> <li>2. A sys.ini configuration file</li> </ol> </div> | Enabled / Disabled | Disabled      |

## SCP

If you select **SCP** as your **Method**, these settings will appear. The SCP (secure copy protocol) method allows you to restore from a configuration file on a remote system.

### Configuration Backup and Restore

Backup
Restore
File Encryption

**Configuration Firmware Version Checking**

Status \*

**APPLY**

---

Method \*

Account \* Password \*

0 / 31 0 / 31

Server IP Address \* File Name \*

0 / 31 0 / 63

**RESTORE**

| UI Setting    | Description   | Valid Range        | Default Value |
|---------------|---|--------------------|---------------|
| <b>Status</b> | Enable or disable configuration file firmware version checking. This checks to make sure the configuration file is for the current firmware version or earlier. | Enabled / Disabled | Disabled      |

| UI Setting               | Description  | Valid Range        | Default Value |
|--------------------------|--|--------------------|---------------|
| <b>Account</b>           | Enter the remote system account name.                            | 1 to 31 characters | N/A           |
| <b>Password</b>          | Enter the remote system account password.                        | 1 to 31 characters | N/A           |
| <b>Server IP Address</b> | Specify the IP address of the remote system.                     | Valid IP address   | N/A           |
| <b>File Name</b>         | Specify the file name of the configuration file to restore from. | N/A                | N/A           |

## SFTP

If you select **SFTP** as your **Method**, these settings will appear. The SFTP method allows you to restore from a configuration file on a remote SFTP server.

The screenshot shows the 'Configuration Backup and Restore' interface. It has three tabs: 'Backup', 'Restore', and 'File Encryption'. The 'Restore' tab is active. Under the heading 'Configuration Firmware Version Checking', there is a 'Status \*' dropdown menu set to 'Enabled' and an 'APPLY' button. Below this, the 'Method \*' dropdown is set to 'SFTP'. There are four input fields: 'Account \*' (0/31), 'Password \*' (0/31) with a clear icon, 'Server IP Address \*' (0/31), and 'File Name \*' (0/63). A 'RESTORE' button is located at the bottom left of the form.

| UI Setting    | Description   | Valid Range        | Default Value |
|---------------|---|--------------------|---------------|
| <b>Status</b> | Enable or disable configuration file firmware version checking. This checks to make sure the configuration file is for the current firmware version or earlier. | Enabled / Disabled | Disabled      |

| UI Setting               | Description  | Valid Range        | Default Value |
|--------------------------|--|--------------------|---------------|
| <b>Account</b>           | Enter the remote system account name.                            | 1 to 31 characters | N/A           |
| <b>Password</b>          | Enter the remote system account password.                        | 1 to 31 characters | N/A           |
| <b>Server IP Address</b> | Specify the IP address of the remote system.                     | Valid IP address   | N/A           |
| <b>File Name</b>         | Specify the file name of the configuration file to restore from. | N/A                | N/A           |

## Configuration Backup and Restore - File Encryption

**Menu Path: System > System Management > Configuration Backup and Restore - File Encryption**

This page lets you configure data encryption settings for exported configuration files.

### Configuration Backup and Restore

Backup
Restore
File Encryption

Configuration File Signature \*

Disabled ▼

Signature Information \*

Encrypt sensitive information only ▼

Key String \*

.... 4 / 30

APPLY

| UI Setting                          | Description  | Valid Range        | Default Value |
|-------------------------------------|--|--------------------|---------------|
| <b>Configuration File Signature</b> | Enables or disables the use of a digital signature for checking the integrity of a configuration file. | Enabled / Disabled | Disabled      |

| UI Setting                   | Description   | Valid Range  | Default Value                      |
|------------------------------|---|--|------------------------------------|
| <b>Signature Information</b> | <p>Select the type of data to encrypt.</p> <p><b>Encrypt sensitive information only:</b> Only encrypt password-related sensitive information in the exported configuration file.</p> <p><b>Encrypt all information:</b> Encrypt all information in the exported configuration file.</p> | Encrypt sensitive information only / Encrypt all information | Encrypt sensitive information only |
| <b>Key String</b>            | Specify an encryption key string. The key string is used to decrypt encrypted configuration files.  | 1 to 30 characters   | moxa                               |

## Account Management

### Menu Path: System > Account Management

This section lets you manage the user accounts used to access the device.

This section includes these pages:

- User Accounts
- Password Policy

## User Accounts

### Menu Path: System > Account Management > User Accounts

This page allows you create, manage, modify, and remove user accounts.

#### Note

1. We strongly recommend changing the default password for the admin account after logging in for the first time.
2. The default admin account cannot be deleted and is enabled by default.
3. Only admin accounts may change the password for supervisor and user accounts.
4. For security reasons, it is recommended for the administrator to keep a record of the account list and associated users.



### ⚠ Warning

Due to the constraints of the IEC 62443-4-2 integrity verification standard, User Accounts will be reset to Factory Default under certain conditions. Specifically, all non-Factory Default user accounts will be entirely removed by the system when the following conditions are all met:

1. The original firmware version of the user device is V.3.0 or higher.
2. The user downgrades the firmware below to V.3.0 and performs any action on this firmware.
3. The firmware version is subsequently upgraded back to V.3.0 or higher.

In cases where all these conditions are satisfied, all user-created non-factory default accounts will be removed.

However, if a user's original firmware version was below V.3.0 and they later upgrade to V.3.0 or subsequent versions, this issue will not arise.

### 🔒 Limitations

You can create up to 10 user accounts.

|                          | Status   | Username    | Authority  | Password Expire |
|--------------------------|----------|-------------|------------|-----------------|
| <input type="checkbox"/> | Enabled  | admin       | Admin      | ---             |
| <input type="checkbox"/> | Enabled  | configadmin | Supervisor | ---             |
| <input type="checkbox"/> | Enabled  | user        | User       | ---             |
| <input type="checkbox"/> | Disabled | test        | User       | ---             |

### UI Setting    Description

|                        |   |
|------------------------|---|
| <b>Status</b>          | Shows if the account is enabled or disabled.  |
| <b>Username</b>        | Shows the username of the account.  |
| <b>Authority</b>       | Shows the authority level of the account.   |
| <b>Password Expire</b> | Shows the number of days left before the password expires for the account. A - means the password will not expire. The password expiration time is determined by the <b>Password Max-life-time</b> setting on the <b>Password Policy</b> page. Refer to <a href="#">System &gt; Account Management &gt; Password Policy</a> for more information. |

## Create New Account

**Menu Path:** System > Account Management > User Accounts - Create New Account

Clicking the **Add (+)** icon on the **System > Account Management > User Accounts** page will open this dialog box. This dialog lets you create a new user account. Click **CREATE** to save your changes and add the new account.

| UI Setting       | Description   | Valid Range               | Default Value |
|------------------|---|---------------------------|---------------|
| <b>Status</b>    | Enable or disable this user account.  | Enabled / Disabled        | N/A           |
| <b>Username</b>  | Enter a user name for this account.   | 4 to 32 characters        | N/A           |
| <b>Authority</b> | Select an authority role for this account. <ul style="list-style-type: none"> <li>• <b>Admin:</b> The account will have read/write access to all configuration parameters.</li> <li>• <b>Supervisor:</b> The account will have read/write access to all configuration parameters except create, delete, and modify accounts.</li> <li>• <b>User:</b> The account can only view configurations and cannot make any modifications.</li> </ul> | Admin / Supervisor / User | N/A           |

**Note**

Refer to User Role Privileges for a list of what read/write access privileges are granted for the different authority levels.

| UI Setting              | Description   | Valid Range   | Default Value |
|-------------------------|---|---|---------------|
| <b>New Password</b>     | Enter a password for this account.<br><br><div style="border: 1px solid #ccc; background-color: #f9f9f9; padding: 5px;"> <p><b>Note</b></p> <p>The new password must follow any requirements set on the <b>System &gt; Account Management &gt; Password Policy</b> page.</p> </div> | 4 to 64 characters, additional requirements are based on settings in <b>System &gt; Account Management &gt; Password Policy</b> | N/A           |
| <b>Confirm Password</b> | Enter the password again to confirm.  | 4 to 64 characters  | N/A           |

## Edit Account Settings



**Menu Path:** System > Account Management > User Accounts - Edit Account Settings

Clicking the **Edit** (✎) icon for an account on the **System > Account Management > User Accounts** page will open this dialog box. This dialog lets you edit an existing user account. Click **APPLY** to save your changes.

**Note**

All account parameters can be modified, except for the username. To modify the username, you must create a new user account.

| UI Setting    | Description                          | Valid Range        | Default Value |
|---------------|--------------------------------------|--------------------|---------------|
| <b>Status</b> | Enable or disable this user account. | Enabled / Disabled | N/A           |

| UI Setting              | Description  | Valid Range   | Default Value |
|-------------------------|--|---|---------------|
| <b>Username</b>         | Shows the username for this account. The username cannot be changed.   | 4 to 32 characters  | N/A           |
| <b>Authority</b>        | Select an authority role for this account. <ul style="list-style-type: none"> <li>• <b>Admin:</b> The account will have read/write access to all configuration parameters.</li> <li>• <b>Supervisor:</b> The account will have read/write access to all configuration parameters except create, delete, and modify accounts.</li> <li>• <b>User:</b> The account can only view configurations and cannot make any modifications.</li> </ul> <div style="background-color: #f0f0f0; padding: 10px; margin-top: 10px;"> <p> <b>Note</b></p> <p>Refer to User Role Privileges for a list of what read/write access privileges are granted for the different authority levels.</p> </div> | Admin / Supervisor / User   | N/A           |
| <b>Old Password</b>     | Enter the old password for this account.   | 4 to 64 characters  | N/A           |
| <b>New Password</b>     | Enter the new password for this account. <div style="background-color: #f0f0f0; padding: 10px; margin-top: 10px;"> <p> <b>Note</b></p> <p>The new password must follow any requirements set on the <b>System &gt; Account Management &gt; Password Policy</b> page.</p> </div>  | 4 to 64 characters, additional requirements are based on settings in <b>System &gt; Account Management &gt; Password Policy</b> | N/A           |
| <b>Confirm Password</b> | Enter the password again to confirm.   | 4 to 64 characters, additional requirements are based on settings in <b>System &gt; Account Management &gt; Password Policy</b> | N/A           |

## Delete User Account

### Menu Path: System > Account Management > User Accounts

You can delete user accounts by using the checkboxes to select the accounts you want to delete, then clicking the **Delete ( 🗑 )** icon.

**Note**

The default admin account is enabled by default and cannot be deleted.

|                                     | Status  | Username    | Authority  | Password Expire |
|-------------------------------------|---------|-------------|------------|-----------------|
| <input type="checkbox"/>            | Enabled | admin       | Admin      | —               |
| <input checked="" type="checkbox"/> | Enabled | configadmin | Supervisor | —               |
| <input type="checkbox"/>            | Enabled | user        | User       | —               |

Max. 10 1 - 3 of 3

## Password Policy

**Menu Path: System > Account Management > Password Policy**

This page allows you to set password complexity rules for user accounts to improve security. Click **APPLY** to save your changes.

**Note**

To improve the security of your device and network, we recommend that you:

- Set the Minimum Length for passwords to 16.
- Enable the Password complexity strength check and enable all the requirement options.
- Set a Password Max-life-time to ensure that users change their password regularly.

### Password Policy

Minimum Length \*  
  
4 - 16

Password complexity strength check  
 Disabled ▼

---

Must contain at least one digit (0-9)  
 Disabled ▼

---

Must include both upper and lower case letters (A-Z, a-z)  
 Disabled ▼

---

Must contain at least one special character (~!@#\$\$%^&\*~\_!~<>{}[]())  
 Disabled ▼

---

Password Max-life-time \*  
  
0 - 365

[APPLY](#)

| UI Setting   | Description   | Valid Range        | Default Value |
|--|---|--------------------|---------------|
| <b>Minimum Length</b>  | Set the minimum required password length.   | 4 to 16 characters | 4             |
| <b>Password complexity strength check</b>  | Enable or disable the password complexity strength check.                                 | Enabled / Disabled | Disabled      |
| <b>Must contain at least one digit (0-9)</b><br>(if Password complexity strength check is Enabled)                                     | Enable or disable requiring the password to contain at least one digit.                   | Enabled / Disabled | Disabled      |
| <b>Must include both upper and lower case letters (A-Z, a-z)</b><br>(if Password complexity strength check is Enabled)                 | Enable or disable requiring the password to include both uppercase and lowercase letters. | Enabled / Disabled | Disabled      |
| <b>Must contain at least one special character</b><br>(~!@#\$\$%^&*~_!~<>{}[]())<br>(if Password complexity strength check is Enabled) | Enable or disable requiring the password to contain at least one special character.       | Enabled / Disabled | Disabled      |

| UI Setting                    | Description   | Valid Range | Default Value |
|-------------------------------|---|-------------|---------------|
| <b>Password Max-life-time</b> | Specify how long in days passwords will be valid for. When the password expires, the system will require the user to change their password. If this is set to 0, passwords will not expire. | 0 to 365    | 0             |

## License Management

### Menu Path: System > License Management

This page lets you add new licenses and view details about existing ones.

This page includes these sections:

- Overview
- License History

### Overview

This section lets you view details about your current license, and lets you add or get a new license. To add or get a new license, click on **ADD NEW LICENSE**, which will guide you through the process.

#### License Management

##### Overview



Name  
**IPS-DEVICE**

Valid Durations (days)  
11248

Start Date  
2022-04-01 12:20:00

End Date  
2053-12-08 02:06:40

Status  
Valid

[Get New License Here](#) 

[ADD NEW LICENSE](#)

##### License History

↻

| Update Date            | Activation Code | License Duration (days) | License Type |
|------------------------|-----------------|-------------------------|--------------|
| 2022-08-16<br>17:29:23 |                 | 11574                   | New          |

1 - 1 of 1

### License History

This area lets you see details about previously installed licenses.

### License Management

**Overview**



Name  
IPS-DEVICE  
Valid Durations (days)  
11248

Start Date  
2022-04-01 12:20:00  
End Date  
2053-12-08 02:06:40

Status  
Valid

[Get New License Here](#) 

[ADD NEW LICENSE](#)

---

**License History**

↻
🔍 Search

| Update Date            | Activation Code | License Duration (days) | License Type |
|------------------------|-----------------|-------------------------|--------------|
| 2022-08-16<br>17:29:23 |                 | 11574                   | New          |

1 - 1 of 1

| UI Setting                     | Description  |
|--------------------------------|--|
| <b>Update Date</b>             | Shows date the license was updated.                  |
| <b>Activation Code</b>         | Shows the activation code of the license.            |
| <b>License Duration (days)</b> | Shows the remaining duration of the license in days. |
| <b>License Type</b>            | Shows the type of license.                           |

## Adding a New License

### Goal

This section provides step-by-step instructions on how to add a new license for your Moxa device.

### Prerequisites

- You will need the registration code for your license. You should have received this by email after purchasing the license.



## Procedure

1. In **System > License Management**, click on the **Add New License** button. A new page with instructions will appear.

### Add New License

1 ————— 2 ————— 3

Login Moxa License Site      Copy Serial Number      Activate

1. Login [Moxa License Site](#) .

2. Choose "Activate a Product License" and product type "Security Package" on the site.

3. Key in the Registration Code and Serial Number on Moxa License Site. Serial Number would be get at the next step.

CLOSE      **NEXT**

2. Click on the **Moxa License Site** link to open a new browser window for the Moxa Software Licensing site and log in.

**MOXA** | Software Licensing      English ▾

### Manage Your Software License

Login Moxa Software Licensing System to activate or query your Moxa software license.

User ID  
[Input Field]

Password  
[Input Field]

[Forgot your password?](#)

I have read and agree with Moxa's Privacy Policy.

**Login**

**Apply for an account**

3. Click on the **Products and Licenses** category at the top of the page to expand it, and then select **Activate a Product License**.

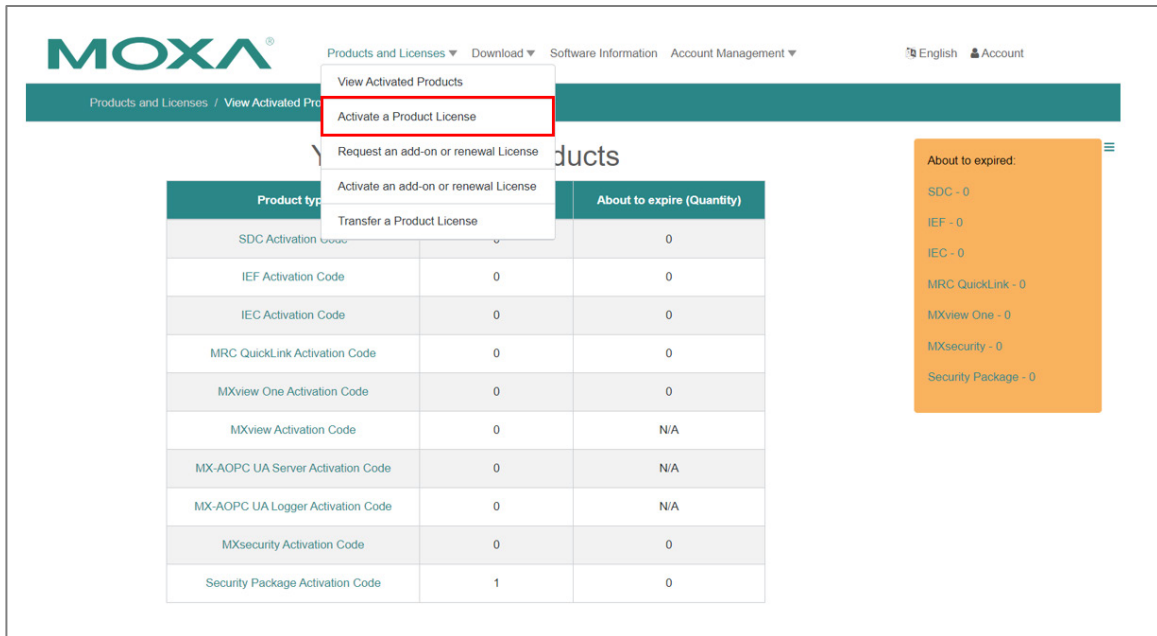

4. Choose the product type for which you want to add a license. In this example, we will be adding a **Security Package**.

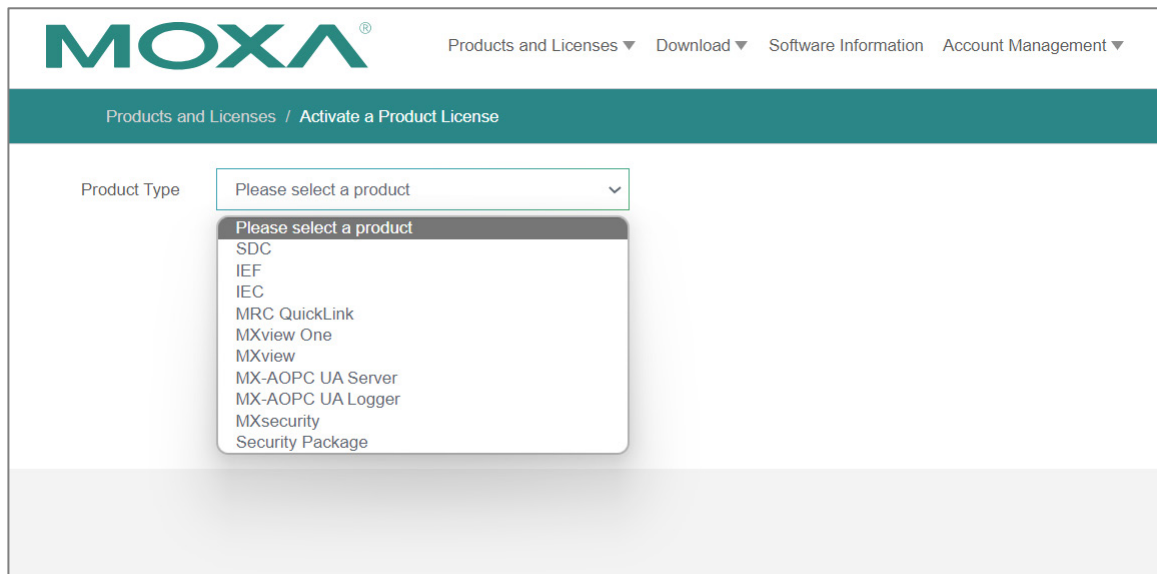

5. Enter the **Registration Code** and click **Activate**.

MOXA® Products and Licenses ▾ Download ▾ Software Information Account Management ▾

Products and Licenses / Activate a Product License

Product Type: Security Package ▾

Registration Code: Enter your registration code

Product type : Function :

Activate

6. Once you click **Activate**, the **Product S/N** (Serial Number) will be displayed, and additional information will appear on the right side of the page.

MOXA® Products and Licenses ▾ Download ▾ Software Information Account Management ▾

Products and Licenses / Activate a Product License

Product Type: Security Package ▾

Registration Code: [Redacted] Product type : Security Package Function : IPS (device-based)

Product S/N: Enter your product S/N code

Activate

7. Back in the Add New License window for your Moxa device, click **NEXT**.

### Add New License

**1**

Login Moxa License Site

**2**

Copy Serial Number

**3**

Activate

1. Login [Moxa License Site](#) .
2. Choose "Activate a Product License" and product type "Security Package" on the site.
3. Key in the Registration Code and Serial Number on Moxa License Site. Serial Number would be get at the next step.

CLOSE NEXT

8. Copy the serial number from the Moxa device UI window and paste it in the **Product S/N** field in the Software Licensing window, then click **ACTIVATE**.

### Add New License

**1**

Login Moxa License Site

**2**

Copy Serial Number

**3**

Activate

Copy the Serial Number to [Moxa License Site](#) .

Serial Number:

CLOSE NEXT

**MOXA**® Products and Licenses ▾ Download ▾ Software Information Account Management ▾

Products and Licenses / Activate a Product License

Product Type

Registration Code

**Product S/N**

Product type : Security Package      Function : IPS (device-based)

Activate

9. A message notification page will appear to confirm that your registration code was successfully activated.

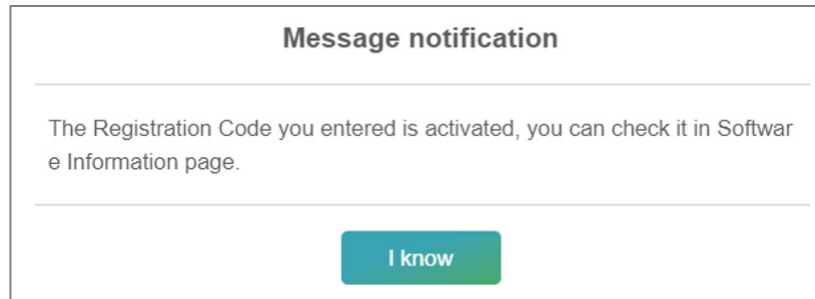

10. In the Software Licensing window, click on **Products and Licenses** to expand it, then select **View Activated Products**.

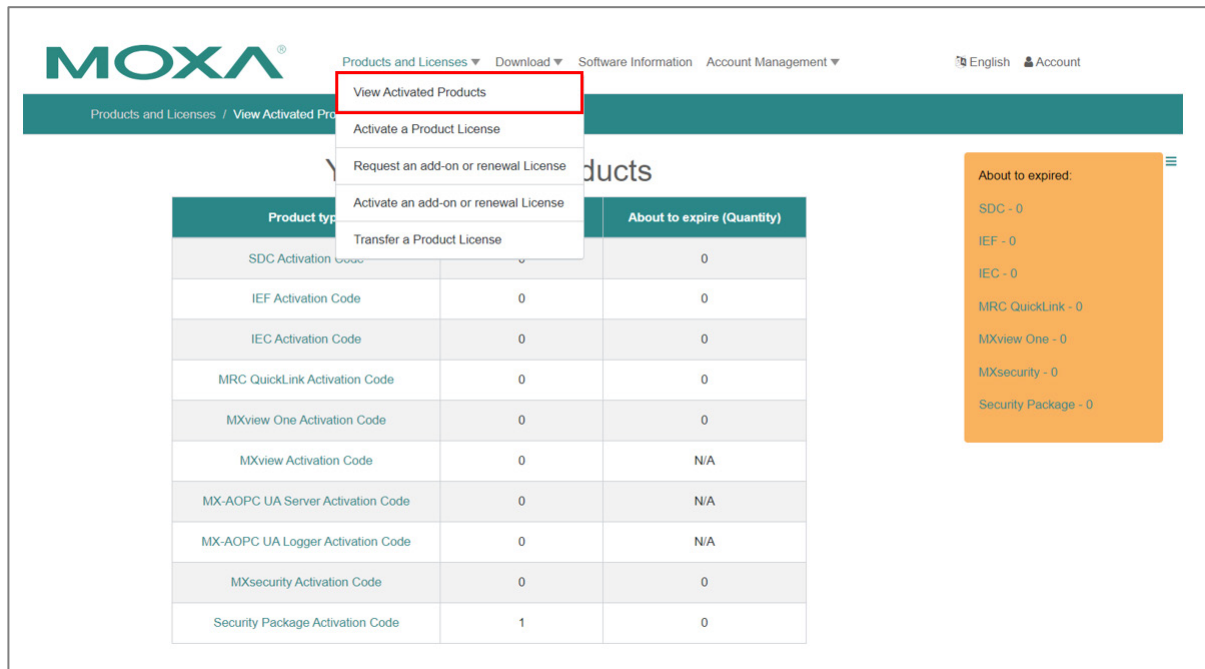

11. Click on the name of the product you just activated. For this example, we need to click on **Security Package Activation Code**.

MOXA® Products and Licenses ▾ Download ▾ Software Information Account Management ▾

Products and Licenses / View Activated Products

### Your Activated Products

| Product type                      | Activated (Quantity) | About to expire (Quantity) |
|-----------------------------------|----------------------|----------------------------|
| SDC Activation Code               | 0                    | 0                          |
| IEF Activation Code               | 0                    | 0                          |
| IEC Activation Code               | 0                    | 0                          |
| MRC QuickLink Activation Code     | 0                    | 0                          |
| MXview One Activation Code        | 0                    | 0                          |
| MXview Activation Code            | 0                    | N/A                        |
| MX-AOPC UA Server Activation Code | 0                    | N/A                        |
| MX-AOPC UA Logger Activation Code | 0                    | N/A                        |
| MXsecurity Activation Code        | 0                    | 0                          |
| Security Package Activation Code  | 1                    | 0                          |

12. Click on **View Activated Products** and then click on the **Activation Code**.

MOXA® Products and Licenses ▾ Download ▾ Software Information Account Management ▾

Products and Licenses / Activated Product List - Security Package

### The product(s) you have activated - Security Package

About to expire ▾

[View Activated Products ▾](#)

Activation Code :

Product S/N :

Valid Start Date : 2023/04/06 15:17:39 Valid End Date : 2023/07/05 23:59:59

Total number of nodes : 1 Due day : 71 day [Update History ▾](#)

Function : IPS (device-based)

[Renewal/Additional Purchase Enquiry](#)

[Renewal/Additional Purchase Activation](#)

13. Copy the activation code that appears in the pop-up notification.

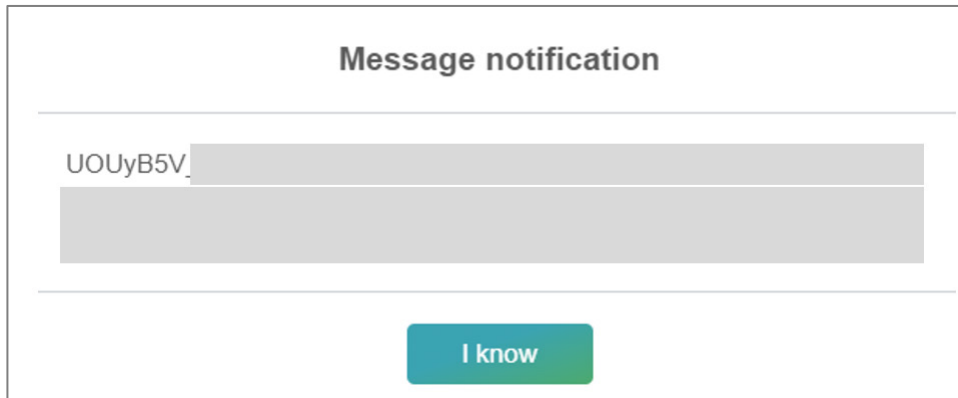

14. In the device UI window, click **NEXT** and paste in your activation code, then click **APPLY**.

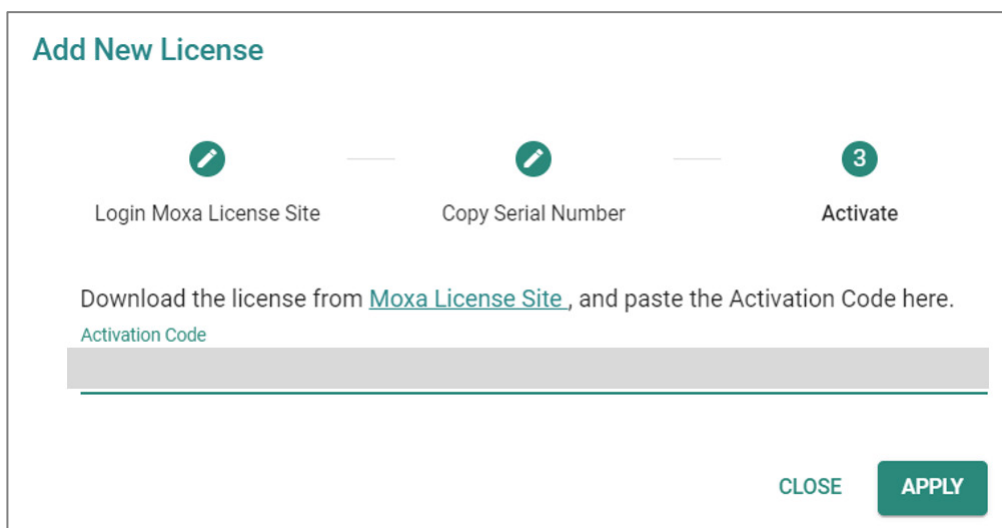

## End Result

You will now see the new license in the **License History** section.

### License Management

**Overview**



Name  
**IPS-DEVICE**

Valid Durations (days)  
**71**

Start Date  
**2023-04-06 03:17:39**

End Date  
**2023-07-05 11:59:59**

Status  
**Valid**

[Get New License Here.](#) 

[ADD NEW LICENSE](#)

**License History**

↻
🔍 Search

| Update Date            | Activation Code | License Duration (days) |
|------------------------|-----------------|-------------------------|
| 2023-04-06<br>16:44:25 | [REDACTED]      | 90                      |

## Management Interface

### Menu Path: System > Management Interface

This section lets you configure the interfaces use to manage the device.

This section includes these pages:

- Out of Band Management
- User Interface
- Ping Response
- Hardware Interface
- SNMP
- Moxa Remote Connect
- MXsecurity

## Out of Band Management

### Menu Path: System > Management Interface > Out of Band Management

This page lets you enable and monitor your device's out of band management port, which segregates traffic from the LAN port to provide a fully isolated and more secure



Ethernet connection. This port uses an independent IP address so users can securely connect and configure devices without interfering with operational traffic.

**Note**

Availability of this feature may vary depending on your product model and version.

This page includes these tabs:

- Settings
- Status

## Out of Band Management - Settings

**Menu Path: System > Management Interface > Out of Band Management - Settings**

This page lets you configure the settings of your device's out of band management port.

|                                      |                      |
|--------------------------------------|----------------------|
| IP Address *                         | Subnet Mask *        |
| 192.168.1.1                          | 24 (255.255.255.0) ▾ |
| <input type="button" value="APPLY"/> |                      |

| UI Setting         | Description   | Valid Range       | Default Value      |
|--------------------|---|-------------------|--------------------|
| <b>IP Address</b>  | Specify the IP address to use for the out of band management port.  | Valid IP address  | 192.168.1.1        |
| <b>Subnet Mask</b> | Specify the subnet mask to use for the out of band management port. | Valid subnet mask | 24 (255.255.255.0) |

## Out of Band Management - Status

**Menu Path: System > Management Interface > Out of Band Management - Settings**

This page lets you view the status of your device's out of band management port.

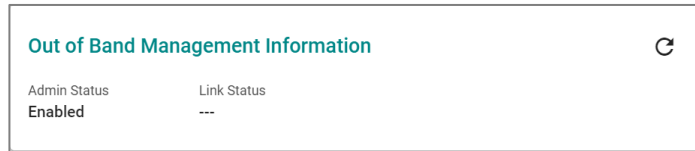

| UI Setting          | Description  |
|---------------------|--|
| <b>Admin Status</b> | Shows whether the out of band management port is enabled or disabled. Refer to <b>System &gt; Management Interface &gt; Hardware Interface</b> for more information. |
| <b>Link Status</b>  | Shows the link status of the out of band management port.  |

## User Interface

### Menu Path: [System > Management Interface > User Interface](#)

This page lets you configure which interfaces can be used to access the device.

#### **Note**

For security reasons, users should access the device using the secure HTTPS and SSH interfaces.

### User Interface

HTTP **Enabled**  TCP Port (HTTP) \* 80  
80, 1024 - 65535

HTTPS **Enabled**  TCP Port (HTTPS) \* 443  
443, 1024 - 65535

Telnet **Enabled**  TCP Port (Telnet) \* 10023  
23, 1024 - 65535

SSH **Enabled**  TCP Port (SSH) \* 22  
22, 1024 - 65535

Ping Response  
**WAN, LAN, lan1, lan...**

Moxa Service **Enabled**

TCP Port for Moxa Service (Encrypted)  
443



UDP Port for Moxa Service (Encrypted)  
40404

Maximum Number of Login Sessions for HTTP+HTTPS \*  
5  
1 - 10

Maximum Number of Login Sessions for Telnet+SSH \*  
5  
1 - 5

**APPLY**

| UI Setting             | Description                         | Valid Range        | Default Value |
|------------------------|-------------------------------------|--------------------|---------------|
| <b>HTTP</b>            | Enable or disable HTTP connections. | Enabled / Disabled | Enabled       |
| <b>TCP Port (HTTP)</b> | Set the TCP port number for HTTP.   | 80, 1024 to 65535  | 80            |

| UI Setting               | Description  | Valid Range         | Default Value |
|--------------------------|--|---------------------|---------------|
| <b>HTTPS</b>             | <p>Enable or disable HTTPS connections.</p> <div style="background-color: #f0f0f0; padding: 10px; margin-top: 10px;"> <p> <b>Note</b></p> <p>The administrator can manually import a self-signed certificate (in .p12 format) for web server (HTTPS) services. However, the administrator should check the root certificate and validity of the signature before importing, according to the organization's security procedures and requirements. After importing a certificate, the administrator should check if the certificate has been revoked and if so, the certificate must be replaced. When the browser verifies the signature and accesses the device, it will return the subject name which the administrator can use to confirm the connected device is authorized.</p> </div> <div style="background-color: #f0f0f0; padding: 10px; margin-top: 20px;"> <p> <b>Note</b></p> <p>The encryption algorithm of keys should be selected based on internationally recognized and proven security practices and recommendations.</p> <p>The lifetime of certificates generated for web server (HTTPS) services should be short and in accordance with the organization's security procedures and requirements.</p> </div> | Enabled / Disabled  | Enabled       |
| <b>TCP Port (HTTPS)</b>  | Set the TCP port number for HTTPS.   | 443, 1024 to 65535  | 443           |
| <b>Telnet</b>            | Enable or disable HTTPS connections.   | Enabled / Disabled  | Enabled       |
| <b>TCP Port (Telnet)</b> | Set the TCP port number for Telnet.  | 23, 1024 to 65535   | 23            |
| <b>SSH</b>               | Enable or disable HTTPS connections.   | Enabled / Disabled  | Enabled       |
| <b>TCP Port (SSH)</b>    | Set the TCP port number for SSH.   | 22, 1024 to 65535   | 22            |
| <b>Ping Response</b>     | <p>Tick the selected interface to be ping.</p> <div style="background-color: #f0f0f0; padding: 10px; margin-top: 10px;"> <p> <b>Note</b></p> <p>To ping selected interface, make sure the interface is checked in <b>Ping Response</b>.</p> </div>  | Drop-down check box | N/A           |

| UI Setting   | Description  | Valid Range        | Default Value |
|--|--|--------------------|---------------|
| <b>MOXA Service</b>                                    | Enable or disable the MOXA Service.<br><br><div style="border: 1px solid #ccc; background-color: #f9f9f9; padding: 10px;"> <p><b>Note</b></p> <p>Moxa Service is only used for Moxa network management software.</p> <p>Moxa Service is only available for user accounts with admin privileges.</p> </div> | Enabled / Disabled | Enabled       |
| <b>TCP Port for Moxa Service (Encrypted)</b>           | The TCP port number for Moxa Service. This setting cannot be changed.  | 443                | 443           |
| <b>UDP Port for Moxa Service (Encrypted)</b>           | The UDP port number for Moxa Service. This setting cannot be changed.  | 40404              | 40404         |
| <b>Maximum Number of Login Sessions for HTTP+HTTPS</b> | Set the maximum combined number of users that can be logged in to the Moxa Router using HTTP and HTTPS.  | 1 to 10            | 5             |
| <b>Maximum Number of Login Sessions for Telnet+SSH</b> | Set the maximum combined number of users that can be logged in to the Moxa Router using Telnet and SSH.  | 1 to 5             | 5             |

## Hardware Interface (all products except TN Series)

**Menu Path:** System > Management Interface > Hardware Interface

This section lets you configure the additional hardware interfaces for your device.

**Note**

Available settings will vary depending on your product model.

USB Function \*

Disabled ▾

Out of Band Interface \*

Enabled ▾

| UI Setting                   | Description   | Valid Range        | Default Value |
|------------------------------|---|--------------------|---------------|
| <b>USB Function</b>          | Enable or disable the USB interface on the device.    | Enabled / Disabled | Enabled       |
| <b>Out of Band Interface</b> | Enable or disable the out of band port on the device. | Enabled / Disabled | Enabled       |

## Hardware Interface (TN Series only)

**Menu Path:** [System](#) > [Management Interface](#) > [Hardware Interface](#)

This page lets you configure the additional hardware interfaces for your device.

This page includes these tabs:

- USB
- Fault LED

### USB

**Menu Path:** [System](#) > [Management Interface](#) > [Hardware Interface - USB](#)

This page lets you enable or disable the USB interface on your device for use with a USB drive.

| UI Setting          | Description  | Valid Range        | Default Value |
|---------------------|--|--------------------|---------------|
| <b>USB Function</b> | Enable or disable the USB interface on the device. | Enabled / Disabled | Enabled       |

### Fault LED

**Menu Path:** [System](#) > [Management Interface](#) > [Hardware Interface - Fault LED](#)

This page lets you select the behavior of the Fault LED.

LED Mode

Moxa Default / System Fault Alarm

Advanced / Configuration Change Alarm

**APPLY**

Fault LED Mode Option Description

|                          | Moxa Default                 | Advanced                           |
|--------------------------|------------------------------|------------------------------------|
| Off                      | Device is operating normally | Device is operating normally       |
| On                       | System Fault                 | System Fault                       |
| Rapid blinking for 6 sec | N/A                          | Configuration Importing and Saving |

| UI Setting      | Description  | Valid Range             | Default Value |
|-----------------|--|-------------------------|---------------|
| <b>LED Mode</b> | <p>Select the behavior mode to use for the Fault LED.</p> <p><b>Moxa Default / System Fault Alarm:</b> The Fault LED will be off when the device is operating normally, and on when there is a system fault.</p> <p><b>Advanced / Configuration Change Alarm:</b> The Fault LED will be off when the device is operating normally, and on when there is a system fault. When the device configuration is being imported and saved, the Fault LED will blink rapidly for 6 seconds.</p> | Moxa Default / Advanced | Moxa Default  |

## SNMP

### Menu Path: System > Management Interface > SNMP

This section lets you configure SNMP settings for your device.

There are two tabs in this section:

- General
- SNMP Account

### SNMP - General

#### Menu Path: System > Management Interface > SNMP - General

This page lets you enable or disable SNMP. SNMP versions V1, V2c, and V3 are supported.

## 🔒 Limitations

You can set up to two community names with corresponding access controls.

The screenshot shows the 'SNMP' configuration page with the 'SNMP Account' tab selected. The 'SNMP Version' dropdown is set to 'V1, V2c, V3'. The 'User-Defined Engine ID' dropdown is set to 'Disabled'. There are two community name entries: 'Community Name 1' is 'public' with 'Access Control 1' set to 'Read Only', and 'Community Name 2' is 'private' with 'Access Control 2' set to 'Read Write'. An 'APPLY' button is located at the bottom left of the configuration area.

| UI Setting   | Description  | Valid Range  | Default Value |
|--|--|--|---------------|
| <b>SNMP Version</b>  | Specify the SNMP protocol version used to manage your device.<br><b>Disabled:</b> Disable SNMP.<br><b>V1, V2c, V3:</b> Enable SNMP V1, V2c, and V3.<br><b>V1, V2c:</b> Enable SNMP V1, V2c only.<br><b>V3 only:</b> Enable SNMP V3 only. | Disabled / V1, V2c, V3 / V1, V2c / V3 only                                   | Disabled      |
| <b>User-Defined Engine ID</b><br>(Only for SNMP Version is V1, V2c, V3 or V3 only) | Enable or disable use of a user-defined engine ID. If disabled, the system will use the default engine ID.   | Disabled / Enabled   | Disabled      |
| <b>Engine ID</b>   | Specify an engine ID to manage your device.<br>If <b>User-Defined Engine ID</b> is disabled, the engine ID will be view-only.  | 2 to 54 hexadecimal character string. The length of the string must be even. | 800021f305    |



| UI Setting              | Description  | Valid Range                        | Default Value |
|-------------------------|--|------------------------------------|---------------|
| <b>Community Name 1</b> | Specify a community string name match to use for authentication.           | 1 to 64 characters                 | public        |
| <b>Community Name 2</b> | Specify a community string name match to use for authentication.           | 1 to 64 characters                 | private       |
| <b>Access Control 1</b> | Specify the access control type to use when Community String 1 is matched. | Read Write / Read only / No Access | Read Only     |
| <b>Access Control 2</b> | Specify the access control type to use when Community String 2 is matched. | Read Write / Read only / No Access | Read Write    |

## SNMP - SNMP Account

**Menu Path: System > Management Interface > SNMP - SNMP Account**

This page lets you configure the SNMP management accounts for the device. SNMP management accounts are provided for Admin and User-level authority.

| Authority | Authentication Type | Encryption Method |
|-----------|---------------------|-------------------|
| Admin     | MDS                 | None              |
| User      | MDS                 | None              |

| UI Setting                 | Description  |
|----------------------------|--|
| <b>Authority</b>           | Shows authority level of the management account.<br><b>admin:</b> Can read/write configuration settings.<br><b>user:</b> Can only read configuration settings. |
| <b>Authentication Type</b> | Shows the authentication type used for the account.  |
| <b>Encryption Method</b>   | Shows the encryption method used for the account.  |

## Edit SNMP Account Settings

**Menu Path:** System > Management Interface > SNMP - SNMP Account

Clicking the **Edit** (✎) icon for an account on the **System > Management Interface > SNMP - SNMP Account** page will open this dialog box. This dialog lets you modify the selected account. Click **APPLY** to save your changes.

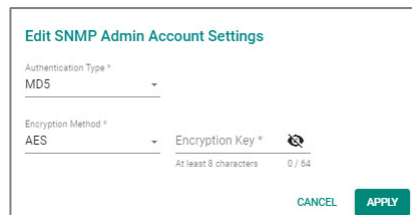

| UI Setting  | Description  | Valid Range        | Default Value |
|---|--|--------------------|---------------|
| <b>Authentication Type</b>                                    | Select which authentication method to use for the account.<br><b>None:</b> No authentication will be used.<br><b>MD5:</b> Use MD5 authentication.<br><b>SHA:</b> Use SHA authentication. | None / MD5 / SHA   | None          |
| <b>Encryption Method</b>                                      | Select which encryption method to use for the account.   | None / DES / AES   | None          |
| <b>Encryption Key</b><br>(if Encryption Method is DES or AES) | Specify an encryption password for the account.  | 8 to 64 characters | N/A           |

## Moxa Remote Connect

**Menu Path:** System > Management Interface > Moxa Remote Connect

This section lets you establish a connection to the MRC Quick Link cloud platform to monitor and remotely access your device. Visit the [Moxa Remote Connect Suite](#) page for more information.

### ✎ Note

Availability of this feature may vary depending on your product model and version.

There are two tabs in this section:

- Settings
- Status

## Moxa Remote Connect - Settings

**Menu Path:** System > Management Interface > Moxa Remote Connect - Settings

This page lets you enable or disable MRC service and configure its connection parameters.

### MRC

Click **APPLY** to activate the device in MRC Quick Link.

Click **RESET KEY** to unbind the device from MRC Quick Link.

#### Note

When the gateway exhibits any of the following behaviors, it will appear as offline in MRC Quick Link:

- Clicking RESET KEY in the MRC settings page of the gateway web console
- Clicking Reset to Defaults in the gateway web console
- Physically pressing the reset button on the hardware

To reactivate the gateway, you will need to perform the deactivate function and download a new activation key in MRC Quick Link and then enter it into the gateway, or create a new gateway in MRC Quick Link and enter a new key into the gateway.

**MRC**

MRC Service \*  
 Disabled ▾

Activation Type \*  
 Enter Activation Key ▾    Activation Key \_\_\_\_\_

**Bridge IP Configuration** ⓘ

IP Address \*                      Subnet Mask \*  
 192.168.126.254                      24 (255.255.255.0) ▾

Bridge Member \* ▾    ⓘ

**APPLY**    RESET KEY

| UI Setting             | Description   | Valid Range                            | Default Value        |
|------------------------|---|--|----------------------|
| <b>MRC Service</b>     | Enable or disable the MRC service for establishing remote access connections.   | Enabled / Disabled                     | Disabled             |
| <b>Activation Type</b> | <p>Select the Activation Type.</p> <p><b>Enter Activation Key:</b> Manually enter an activation key for authentication.</p> <p><b>Import from USB drive:</b> Insert a USB drive that has an activation key on it for authentication.</p> <div style="background-color: #f0f0f0; padding: 5px; margin-top: 10px;"> <p><b>Note</b></p> <p>To use this, USB functionality must be enabled in <b>System &gt; Management Interface &gt; Hardware Interface</b>.</p> </div> | Enter Activation Key / Import from USB | Enter Activation Key |

### Bridge IP Configuration

| UI Setting        | Description                           | Valid Range      | Default Value   |
|-------------------|---------------------------------------|------------------|-----------------|
| <b>IP Address</b> | Specify an IP address for the bridge. | Valid IP address | 192.168.126.254 |

| UI Setting           | Description   | Valid Range             | Default Value     |
|----------------------|---|-------------------------|-------------------|
| <b>Subnet Mask</b>   | Specify a subnet mask for the bridge.   | Valid subnet mask       | 24(255.255.255.0) |
| <b>Bridge Member</b> | <p>Select which ports will be members of the bridge.</p> <div style="background-color: #f0f0f0; padding: 5px; margin-bottom: 10px;"> <p><b>Note</b></p> <p>Only devices connected to the Bridge port can be remotely accessed via MRC service. Please ensure that the device's IP and the Bridge IP are set within the same subnet.</p> </div> <div style="background-color: #f0f0f0; padding: 5px;"> <p><b>Note</b></p> <p>Bridge members are limited to LAN ports only. If any port is used as a WAN port, please do not add that port as a bridge member to avoid affecting the WAN network settings.</p> </div> | Drop-down list of ports | N/A               |

## Tunnel Control Settings

**Tunnel Control Settings**

Tunnel Control ▼

---

| UI Setting            | Description   | Valid Range  | Default Value        |
|-----------------------|---|--|----------------------|
| <b>Tunnel Control</b> | <p>Select the Tunnel Control Type.</p> <p><b>Persistent Connection:</b> Always establish a tunnel for remote access.</p> <p><b>Controlled by Key file from USB drive:</b> Establish a tunnel for remote access only when a USB containing the key is inserted into the device.</p> <div style="border: 1px solid #ccc; background-color: #f9f9f9; padding: 10px; margin: 10px 0;"> <p><b>Note</b></p> <p>This feature requires <b>USB Function</b> to be enabled in <b>System &gt; Management Interface &gt; Hardware Interface</b>.</p> </div> <p><b>Controlled by DI:</b> Establish a tunnel for remote access only when the Digital Input is detected as On.</p> | Persistent Connection /<br>Controlled by USB Key /<br>Controlled by DI | Permanent Connection |

## Moxa Remote Connect - Status

**Menu Path:** [System > Management Interface > Moxa Remote Connect - Status](#)

This page lets you view the status and details of your Moxa Remote Connect connection.

### MRC Information

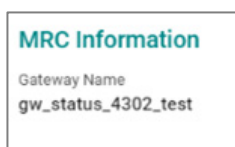

| UI Setting          | Description                                      |
|---------------------|--|
| <b>Gateway Name</b> | Shows the name of this device in MRC Quick Link. |

### MRC Status

This shows the current status of your MRC connection.



| UI Setting              | Description  |
|-------------------------|--|
| <b>Internet</b>         | Shows the status of your device's Internet connection.<br><b>Green:</b> The device is connected to the Internet.<br><b>Red:</b> The device failed to connect to the Internet.<br><b>Gray:</b> The device has not been activated yet. |
| <b>MRC Cloud</b>        | Shows the status of your device's MRC Cloud connection.<br><b>Green:</b> Connected to MRC Cloud successfully.<br><b>Red:</b> Failed to connect to MRC Cloud.<br><b>Gray:</b> Have not tried to connect to MRC Cloud yet.             |
| <b>Key Verification</b> | Shows the status of your device's key verification.<br><b>Green:</b> Successfully verified the activation key.<br><b>Red:</b> Failed to verify the activation key.<br><b>Gray:</b> Have not tried to verify the activation key yet.  |
| <b>Online</b>           | Shows the status of your device in MRC Quick Link.<br><b>Green:</b> Device online.<br><b>Red:</b> Device offline.<br><b>Gray:</b> Device not authenticated yet.  |
| <b>Connected</b>        | Shows the status of your device's remote connection.<br><b>Green:</b> Remote connection established successfully.<br><b>Red:</b> Failed to establish remote connection.<br><b>Gray:</b> Remote connection not yet established yet.   |

## Local Device List

| Local Device List |   |                    |               |            |                      |
|-------------------|---|--------------------|---------------|------------|----------------------|
| Local Device Name | Status                                      | Device Type        | IP Address    | Virtual IP | Connectivity Check   |
| device_903        | <span style="color: green;">●</span> Online | IP Ethernet Device | 192.168.126.3 | 10.11.64.2 | Ping Check (10 sec.) |

| UI Setting               | Description  |
|--------------------------|--|
| <b>Local Device Name</b> | Shows the name of the local device connected to this device. |
| <b>Status</b>            | Shows the connection status of the local device.             |

| UI Setting                | Description  |
|---------------------------|--|
| <b>Device Type</b>        | Shows the type of the local device. (IP Ethernet Device / Layer 2 Ethernet Device / Serial Device) |
| <b>IP Address</b>         | Shows the IP address of the local device.  |
| <b>Virtual IP</b>         | Shows the virtual IP address of the local device that is assigned by the MRC Quick Link server.    |
| <b>Connectivity Check</b> | Shows how the local device's alive status will be checked for connectivity.                        |

## MXsecurity

### Menu Path: System > Management Interface > MXsecurity

This page lets you establish a connection to an MXsecurity instance to monitor and manage the device.

After configuring the connection parameters, click **CONNECT** to establish the connection.

#### Note

To manage your the device through MXsecurity, the MXsecurity Agent Package must be installed and enabled first. Refer to the Software Package Management section for more information and instructions.

### MXsecurity

#### Connection Status

|   |                                    |
|---|------------------------------------|
| Status<br><b>Connecting</b>             | Package Version<br><b>1.0.0017</b> |
| Service Address<br><b>3.129.140.152</b> | Profile Synchronization<br>---     |

#### New Connection

Service Address

0 / 64

HTTPS Port  
**443**

1 - 65535

Communication Port  
**8883**

1 - 65535

**CONNECT**



| UI Setting                | Description   | Valid Range                     | Default Value |
|---------------------------|---|---------------------------------|---------------|
| <b>Service Address</b>    | Set the MXsecurity server IP address or domain name.  | Valid IP address or domain name | N/A           |
| <b>HTTPS Port</b>         | Specify the HTTPS port number for MXsecurity.         | 1 to 65535                      | 443           |
| <b>Communication Port</b> | Specify the communication port number for MXsecurity. | 1 to 65535                      | 8833          |

## Ping Response

### Menu Path: System > Management Interface > Ping Response Policy

This page allows you to configure and manage ping response policies that let you control how your device handles incoming ping requests.

### Ping Response Settings

**Allow Ping Response by Default**

Status: Enabled Interfaces Allowing Default Ping Response: WAN, LAN

---

**Ping Response Logging and Events**

Log: Disabled Severity: Emergency Log Destination:

## Allow Ping Response by Default

| UI Setting                                       | Description   | Valid Range                  | Default Value       |
|--|---|------------------------------|---------------------|
| <b>Status</b>                                    | <p>Enable or disable allowing ping responses to ping requests through the specified interfaces by default.</p> <div style="background-color: #f0f0f0; padding: 5px; margin: 5px 0;"> <p><b>Note</b></p> <p>If Status is set to Disabled, ping responses will be denied for all ping requests by default.</p> </div> <div style="background-color: #f0f0f0; padding: 5px; margin: 5px 0;"> <p><b>Note</b></p> <p>Ping response policies will override the default behavior.</p> </div> | Enabled / Disabled           | Disabled            |
| <b>Interfaces Allowing Default Ping Response</b> | Select the interfaces to allow ping responses for by default.   | Drop-down list of interfaces | Existing interfaces |

## Ping Response Default Rule Event Setting

| UI Setting             | Description  | Valid Range   | Default Value |
|------------------------|--|---|---------------|
| <b>Log</b>             | Enable or disable global policy event logging. This will allow event logging for actions taken due to the global policy.       | Enabled / Disabled  | Disabled      |
| <b>Severity</b>        | <a href="#">Select the severity level to assign events for this policy. Refer to Severity Level List for more information.</a> | Emergency / Alert / Critical / Error / Warning / Notice / Informational / Debug | N/A           |
| <b>Log Destination</b> | Select the default action log destination.   | Syslog / Trap / Local Storage   | N/A           |

## Ping Response Policy List

| <input type="checkbox"/> | Index | Status | Incoming Interface | IP Address/Netmask | Action |
|--------------------------|-------|--------|--------------------|--------------------|--------|
|--------------------------|-------|--------|--------------------|--------------------|--------|

Max. 16      Items per page: 50      0 of 0      |< < > >|

**APPLY**

| UI Setting                | Description  |
|---------------------------|--|
| <b>Index</b>              | Shows the index of the ping response policy.   |
| <b>Status</b>             | Shows whether the policy is enabled.   |
| <b>Incoming Interface</b> | Shows the interface this policy will monitor for ping requests through this policy.                        |
| <b>IP Address/Netmask</b> | Shows the IP address and netmask to monitor for ping requests through this policy.                         |
| <b>Action</b>             | Shows whether the device will allow or deny ping responses for matching ping requests through this policy. |

### Create Ping Response Policy

**Menu Path:** [System](#) > [Management Interface](#) > [Ping Response Policy](#)

Clicking the **Add (+)** icon on the

Unable to render include or excerpt-include. Could not retrieve page.

page will open this dialog box. This dialog lets you create a new ping response policy.

Click **CREATE** to save your changes and add the new policy.

### Add Ping Response Policy

Index \*  
1

Status \*  
Disabled

Incoming Interface \*  
\_\_\_\_\_

IP Type \*  
Any

Action \*  
\_\_\_\_\_

CANCEL
APPLY

| UI Setting  | Description   | Valid Range                  | Default Value        |
|---|---|------------------------------|----------------------|
| <b>Index</b>  | Specify the index for the ping response policy.   | 1 to 16                      | Next available index |
| <b>Status</b>   | Enable or disable the ping response policy.   | Enabled /Disabled            | Disabled             |
| <b>Incoming Interface</b>                                 | Select the interface this policy will monitor for ping requests.  | Drop-down list of interfaces | N/A                  |
| <b>IP Type</b>  | Select the IP type to monitor for ping requests for this policy.  | Any / Single IP / Subnet     | Any                  |
| <b>IP Address<br/>(If IP Type is Single IP or Subnet)</b> | Specify the IP address to monitor for ping requests through this policy.                                    | Valid IP Address             | N/A                  |
| <b>Netmask<br/>(If IP Type is Subnet)</b>                 | Specify the netmask to monitor for ping requests through this policy.                                       | Drop-down list of netmask    | N/A                  |
| <b>Action</b>   | Select whether the device will allow or deny ping responses for matching ping requests through this policy. | Allow / Deny                 | N/A                  |

## Edit Ping Response Policy

### Menu Path: System > Management Interface > Ping Response Policy

Clicking the **Edit** (✎) icon for a policy on the

Unable to render include or excerpt-include. Could not retrieve page.

page will open this dialog box. This dialog lets you edit an existing policy.

Click **APPLY** to save your changes.

### Edit Ping Response Policy

Index \*  
1

Status \*  
Disabled

Incoming Interface \*  
WAN

IP Type \*  
Any

Action \*  
Allow

CANCEL APPLY

| UI Setting                | Description  | Valid Range                  | Default Value        |
|---------------------------|--|------------------------------|----------------------|
| <b>Index</b>              | Specify the index for the ping response policy.                  | 1 to 16                      | Next available index |
| <b>Status</b>             | Enable or disable the ping response policy.                      | Enabled /Disabled            | Disabled             |
| <b>Incoming Interface</b> | Select the interface this policy will monitor for ping requests. | Drop-down list of interfaces | N/A                  |
| <b>IP Type</b>            | Select the IP type to monitor for ping requests for this policy. | Any / Single IP / Subnet     | Any                  |

| UI Setting   | Description   | Valid Range               | Default Value |
|--|---|---------------------------|---------------|
| <b>IP Address</b><br>(If IP Type is Single IP or Subnet) | Specify the IP address to monitor for ping requests through this policy.                                    | Valid IP Address          | N/A           |
| <b>Netmask</b><br>(If IP Type is Subnet)                 | Specify the netmask to monitor for ping requests through this policy.                                       | Drop-down list of netmask | N/A           |
| <b>Action</b>  | Select whether the device will allow or deny ping responses for matching ping requests through this policy. | Allow / Deny              | N/A           |

## Delete Ping Response Policy

### Menu Path: [System](#) > [Management Interface](#) > [Ping Response Policy](#)

You can delete an policy by using the checkboxes to select the entries you want to delete, then clicking the **Delete** (  ) icon.

## Time

### Menu Path: [System](#) > [Time](#)

This section lets you configure the system time settings for your device.

This section includes these pages:

- System Time
- NTP/SNTP Server

## System Time

### Menu Path: [System](#) > [Time](#) > [System Time](#)

This section lets you set up time settings for the device itself.

This page includes these tabs:

- Time
- Time Zone

- NTP Authentication

 **Note**

This device does not include a real-time clock. If there is no NTP/SNTP server on the network or if the device is not connected to the Internet, the Current Time and Current Date must be manually reconfigured after each reboot.

## System Time - Time

**Menu Path: System > Time > System Time - Time**

This page lets you set the system time and date.

You can set your system time using these clock sources:

- Local
- SNTP
- NTP

### System Time Settings - Local

If you select **Local** as your **Clock Source**, these settings will appear. Local lets you set your device's system time manually, or you can copy the time from your local host by clicking **SYNC FROM BROWSER**. Click **APPLY** to save your changes.

## System Time

Time
Time Zone
NTP Authentication

Current Time  
1970-04-18 11:13:36 UTC+08:00

---

Clock Source  
Local ▼

Date \*  
1970-04-18 📅

Time  
上午 11:13 🕒

APPLY
SYNC FROM BROWSER

| UI Setting          | Description   | Valid Range | Default Value |
|---------------------|---|-------------|---------------|
| <b>Current Time</b> | This shows the device's current system date, time, and time zone. | N/A         | N/A           |
| <b>Date</b>         | Specify the date manually in YYYY-MM-DD format.                   | YYYY-MM-DD  | Current date  |
| <b>Time</b>         | Specify the time manually in HH:MM AM/PM format.                  | HH:MM AM/PM | Current time  |

### System Time Settings - SNTP

If you select **SNTP** as your **Clock Source**, these settings will appear. SNTP allows your device to update its system time from a Simplified Network Time Protocol (SNTP) time server. Click **APPLY** to save your changes.



### System Time

| Time  | Time Zone | NTP Authentication |
|---|-----------|--------------------|
| Current Time<br>1970-04-18 11:13:36 UTC+08:00 |           |                    |
| Clock Source<br>SNTP                          |           |                    |
| Time Server 1<br>0 / 39                       |           |                    |
| Time Server 2<br>0 / 39                       |           |                    |
| <b>APPLY</b>                                  |           |                    |

| UI Setting           | Description   | Valid Range                              | Default Value |
|----------------------|---|--|---------------|
| <b>Current Time</b>  | This shows the device's current system date, time, and time zone.   | N/A                                      | N/A           |
| <b>Time Server 1</b> | Set the IP or domain address of the primary time server (e.g., 192.168.1.1, <a href="http://time.stdtime.gov.tw">time.stdtime.gov.tw</a> , or <a href="http://time.nist.gov">time.nist.gov</a> ). | IP address or domain, 1 to 39 characters | N/A           |
| <b>Time Server 2</b> | Set the IP or domain address of the secondary time server. This will be used by the device if it cannot connect to the primary time server.   | IP address or domain, 1 to 39 characters | N/A           |

### System Time Settings - NTP

If you select **NTP** as your **Clock Source**, these settings will appear. NTP allows your device to update its system time from a Network Time Protocol (NTP) server. Click **APPLY** to save your changes.

**Note**

When synchronizing device time using NTP, we recommend using NTP authentication to reduce cybersecurity risks.

## System Time

Time
Time Zone
NTP Authentication

Current Time  
1970-04-18 11:13:36 UTC+08:00

---

Clock Source  
NTP

Time Server 1  
0 / 39

Time Server 2  
0 / 39

Authentication  
Disabled

Authentication  
Disabled

APPLY

| UI Setting            | Description  | Valid Range   | Default Value |
|-----------------------|--|---|---------------|
| <b>Current Time</b>   | This shows the device's current system date, time, and time zone.  | N/A   | N/A           |
| <b>Time Server 1</b>  | Set the IP or domain address of the primary time server (e.g., 192.168.1.1, <a href="http://time.stdtime.gov.tw">time.stdtime.gov.tw</a> , or <a href="http://time.nist.gov">time.nist.gov</a> ).  | IP address or domain, 1 to 39 characters                        | N/A           |
| <b>Time Server 2</b>  | Set the IP or domain address of the secondary time server. This will be used by the device if it cannot connect to the primary time server.  | IP address or domain, 1 to 39 characters                        | N/A           |
| <b>Authentication</b> | Specify whether to disable or use a key ID for NTP server authentication.<br><br><div style="background-color: #f0f0f0; padding: 5px; margin-top: 5px;">           To use authentication, set up the Key ID value in the <b>NTP Authentication</b> tab first. After setting it up, it will become available in the <b>Authentication</b> drop-down.         </div> | Disabled / Key IDs created in the <b>NTP Authentication</b> tab | Disabled      |

## System Time - Time Zone

**Menu Path:** System > Time > System Time - Time Zone

This page lets you set the time zone settings of your device. Click **APPLY** to save your changes.

**Note**

Changing the time zone will automatically adjust the device's system time. Be sure to set the time zone before setting the system time.

**System Time**

Time    Time Zone    NTP Authentication

Time Zone  
(UTC+08:00)Taipei

Daylight Saving  
Daylight Saving Status  
Disabled

APPLY

| UI Setting  | Description   | Valid Range              | Default Value |
|---|---|--------------------------|---------------|
| <b>Time Zone</b>                                      | Select a time zone from the list of UTC (Coordinated Universal Time) time zones.  | N/A                      | N/A           |
| <b>Daylight Saving Status</b>                         | Enable or disable Daylight Saving time adjustment.                                | Enabled / Disabled       | Disabled      |
| <b>Offset (if Daylight Saving Status is Enabled)</b>  | Set the offset (in hours) to add to the time when Daylight Saving time is active. | 0 to 12                  | 0             |
| <b>Month (if Daylight Saving Status is Enabled)</b>   | Set the month Daylight Saving time begins/ends.                                   | User-specified month     | N/A           |
| <b>Week (if Daylight Saving Status is Enabled)</b>    | Set the week Daylight Saving time begins/ends.                                    | User-specified week      | N/A           |
| <b>Day (if Daylight Saving Status is Enabled)</b>     | Set the day of the week Daylight Saving time begins/ends.                         | User-specified day       | N/A           |
| <b>Hour (if Daylight Saving Status is Enabled)</b>    | Set the hour Daylight Saving time begins/ends.                                    | User-specified hour      | 00            |
| <b>Minutes (if Daylight Saving Status is Enabled)</b> | Set the minute Daylight Saving time begins/ends.                                  | User-specified minute(s) | 00            |

## System Time - NTP Authentication

### Menu Path: System > Time > System Time - NTP Authentication

This section describes how to configure NTP Authentication. After creating a key, it will be available for use in the **Time** tab. Click **APPLY** to save your changes.

#### Note

When synchronizing device time using NTP, we recommend using NTP authentication to reduce cybersecurity risks.

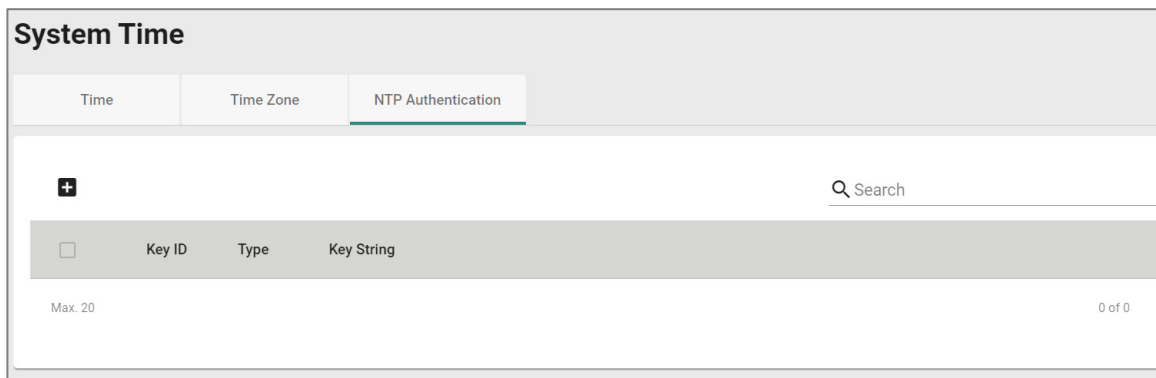

| Time  | Time Zone | NTP Authentication |
|---|-----------|--------------------|
|  <span style="float: right;">Search</span> |           |                    |
| Key ID  | Type      | Key String         |
| Max. 20 <span style="float: right;">0 of 0</span>   |           |                    |

| UI Setting        | Description  |
|-------------------|--|
| <b>Key ID</b>     | Shows the key ID for the authentication key.   |
| <b>Type</b>       | Shows the type of NTP authentication the key uses.<br><b>MD5:</b> Uses authentication based on MD5 algorithms.<br><b>SHA:</b> Uses authentication based on SHA-512 algorithms. |
| <b>Key String</b> | Shows the key string used by the authentication key.   |

### Create Entry

#### Menu Path: System > Time > System Time - NTP Authentication - Create Entry

Clicking the **Add** () icon on the **System > Time > System Time - NTP Authentication** page will open this dialog box. This dialog lets you create a new NTP authentication key. Click **CREATE** to save your settings and create the new authentication key.

### Create Entry

Key ID \*  
1 - 65535

Type \*  
▼

Key String \* 0 / 32

CANCEL CREATE

| UI Setting        | Description  | Valid Range           | Default Value |
|-------------------|--|-----------------------|---------------|
| <b>Key ID</b>     | Specify the key ID to use for the authentication key.  | 1 to 65535 characters | N/A           |
| <b>Type</b>       | Specify the type of NTP authentication the key should use.<br><br><b>MD5:</b> Sets authentication based on MD5 algorithms.<br><b>SHA:</b> Sets authentication based on SHA-512 algorithms. | MD5 / SHA-512         | N/A           |
| <b>Key String</b> | Specify the key string to use for the authentication key.  | 1 to 32 characters    | N/A           |

## Edit Entry

**Menu Path:** System > Time > System Time - NTP Authentication - Edit Entry

Clicking the **Edit** ( ) icon for a key on the **System > Time > System Time - NTP Authentication** page will open this dialog box. This dialog lets you edit an existing authentication key. Click **APPLY** to save your settings.

**Note**

All key parameters can be modified, except for the key ID. To modify the key ID, you must create a new authentication key.

**Edit Entry Settings**

Key ID  
1  
1 - 65535

Type \*  
MD5

Key String \*  
0 / 32

CANCEL APPLY

| UI Setting        | Description  | Valid Range        | Default Value  |
|-------------------|--|--------------------|----------------|
| <b>Key ID</b>     | Shows the key ID for this authentication key. The key ID cannot be changed.  | N/A                | Current key ID |
| <b>Type</b>       | Specify the type of NTP authentication the key should use.<br><b>MD5</b> : Sets authentication based on MD5 algorithms.<br><b>SHA</b> : Sets authentication based on SHA-512 algorithms. | MD5 / SHA-512      | N/A            |
| <b>Key String</b> | Specify the key string to use for the authentication key.  | 1 to 32 characters | N/A            |

### Delete Entry

You can delete authentication keys by using the checkboxes to select the keys you want to delete, then clicking the **Delete (🗑)** icon.

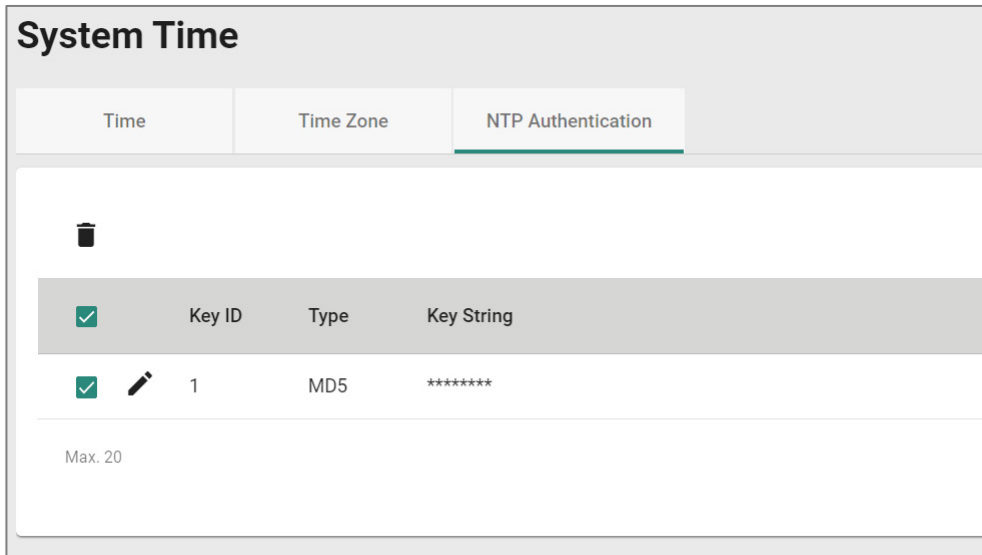

## NTP/SNTP Server

**Menu Path:** System > Time > NTP/SNTP Server

NTP/SNTP server allows you to set up: **NTP/SNTP Server, Client Authentication.**  
While finished, Click **APPLY** to save the settings.

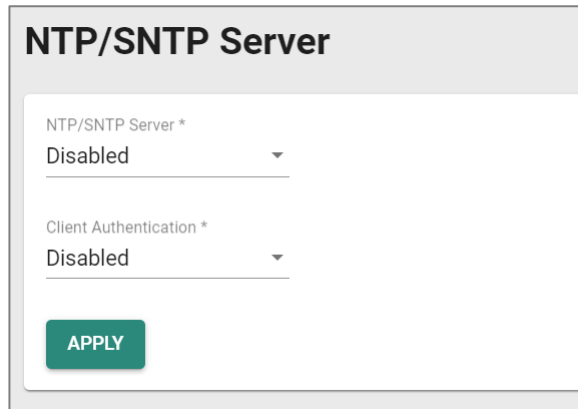

| UI Setting             | Description   | Valid Range               | Default Value   |
|------------------------|---|---------------------------|-----------------|
| <b>NTP/SNTP Server</b> | Enable or disable NTP/SNTP server functionality for clients:<br><b>Enabled:</b> Enable NTP/SNTP server functionality for clients.<br><b>Disabled:</b> Disabled NTP/SNTP server functionality for clients. | <b>Enabled / Disabled</b> | <b>Disabled</b> |

| UI Setting                   | Description  | Valid Range               | Default Value   |
|------------------------------|--|---------------------------|-----------------|
| <b>Client Authentication</b> | <p>Enable or disable client authentication of NTP/SNTP server:</p> <p><b>Enabled:</b> Enable Client Authentication functionality for clients.</p> <div style="border: 1px solid #ccc; background-color: #f9f9f9; padding: 10px; margin: 10px 0;"> <p> <b>Note</b></p> <p>Before enabling Client Authentication, you will need to create NTP authentication keys first.</p> <p>Refer to <a href="#">System &gt; System Time - NTP Authentication</a> for more information.</p> </div> <p><b>Disabled:</b> Disable Client Authentication functionality for clients.</p> | <b>Enabled / Disabled</b> | <b>Disabled</b> |

## Power Management

### Menu Path: System > Power Management

This page lets you configure the power management features of your device.

 **Note**

Availability of this feature may vary depending on your product model and version.

This page includes these tabs:

- General
- Scheduling
- Ignition

## Power Management - General

### Menu Path: System > Power Management - General

This page lets you enable power management for your device. If enabled, you can control how and when the device enters a power-saving state. If disabled, the device will never enter power-saving mode.



## Power Management

General
Scheduling
Ignition

Power Management \*

Disabled ▼

**APPLY**

| UI Setting              | Description   | Valid Range                      | Default Value |
|-------------------------|---|----------------------------------|---------------|
| <b>Power Management</b> | <p>Select a power management setting for your device.</p> <p><b>Disabled:</b> Disables power management.</p> <p><b>Scheduling:</b> Enables power-saving mode based on a schedule you define. Refer to Scheduling for more details.</p> <p><b>Ignition:</b> Enables power-saving mode based on signals sent to the digital input, allowing the device to enter power-saving mode when a vehicle ignition is off.</p> | Disabled / Scheduling / Ignition | Disabled      |

## Power Management - Scheduling

**Menu Path:** System > Power Management - Scheduling

This page lets you create both one-time and repeating schedules to determine when the device should enter and leave power-saving mode.

## 🔒 Limitations

You can create up to 2 cycle rules, and up to 12 one-time rules.

- Both cycle rules must use the same Cycle Type. If the Cycle Type is changed, all existing cycle rules will be deleted.
- If the Cycle Type is set to Weekly or Monthly, the start and end times must be within the same day. If you need the start and end times to be on different days, create a One Time Rule.

## Wakeup Cycle Rules

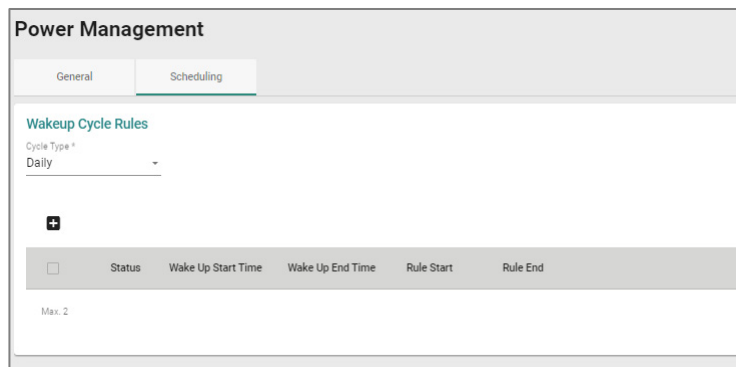

| UI Setting        | Description  | Valid Range                       | Default Value |
|-------------------|--|-----------------------------------|---------------|
| <b>Cycle Type</b> | <p>Select a wakeup cycle to use for power-saving mode scheduling.</p> <p><b>Hourly:</b> The device will enter and leave power-saving mode according to specific times every hour.</p> <p><b>Daily:</b> The device will enter and leave power-saving mode according to specific times every day.</p> <p><b>Weekly:</b> The device will enter and leave power-saving mode according to specific times on specific days of the week. Multiple days of the week may be selected.</p> <p><b>Monthly:</b> The device will enter and leave power-saving mode according to specific times on specific days of the month. Multiple days of the month may be selected.</p> | Hourly / Daily / Weekly / Monthly | Daily         |

## Wakeup Cycle Rule List

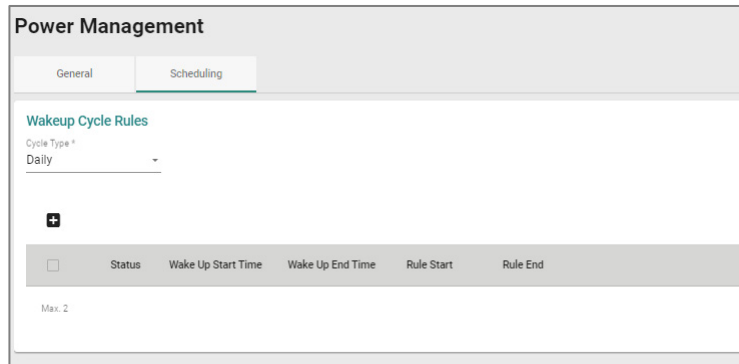

| UI Setting                | Description   |
|---------------------------|---|
| <b>Status</b>             | Shows the status of the wakeup cycle rule.  |
| <b>Wake Up Start Time</b> | Shows when the device will leave power-saving mode.<br>The units shown will vary depending on the wakeup cycle type used. |
| <b>Wake Up End Time</b>   | Shows when the device will enter power-saving mode.<br>The units shown will vary depending on the wakeup cycle type used. |
| <b>Rule Start</b>         | Shows when the wakeup cycle rule will start taking effect.  |
| <b>Rule End</b>           | Shows when the wakeup cycle rule will no longer take effect.  |

### Add Cycle Rule

#### Menu Path: System > Power Management - Scheduling

Clicking the **Add (+)** icon in the **Wakeup Cycle Rule List** on the **System > Power Management - Scheduling** page will open this dialog box. This dialog lets you create a new wakeup cycle rule. The options shown will vary depending on what **Cycle Type** is selected.

Click **CREATE** to save your changes and add the new rule.

## Add Cycle Rule - Hourly

If the **Cycle Type** is set to **Hourly**, these options will appear.

| UI Setting               | Description  | Valid Range        | Default Value |
|--------------------------|--|--------------------|---------------|
| <b>Status</b>            | Enable or disable the cycle rule.  | Enabled / Disabled | Enabled       |
| <b>Wakeup Start Time</b> | Specify the minute when the device will leave power-saving mode each hour. | 00 to 59           | 00            |
| <b>Wakeup End Time</b>   | Specify the minute when the device will enter power-saving mode each hour. | 00 to 59           | 15            |
| <b>Start Date</b>        | Specify when this cycle rule will take effect.                             | Date               | N/A           |
| <b>End Date</b>          | Specify when this cycle rule will end.                                     | Date               | N/A           |

## Add Cycle Rule - Daily

If the **Cycle Type** is set to **Daily**, these options will appear.

| UI Setting               | Description   | Valid Range        | Default Value |
|--------------------------|---|--------------------|---------------|
| <b>Status</b>            | Enable or disable the cycle rule.   | Enabled / Disabled | Enabled       |
| <b>Wakeup Start Time</b> | Specify the hour and minute when the device will leave power-saving mode every day. You can also click the clock icon to select the time from a drop-down list. | Time               | 12:00 AM      |
| <b>Wakeup End Time</b>   | Specify the hour and minute when the device will enter power-saving mode every day. You can also click the clock icon to select the time from a drop-down list. | Time               | 12:15 AM      |
| <b>Start Date</b>        | Specify when this cycle rule will take effect.  | Date               | N/A           |
| <b>End Date</b>          | Specify when this cycle rule will end.  | Date               | N/A           |

### Add Cycle Rule - Weekly

If the **Cycle Type** is set to **Weekly**, these options will appear.

| UI Setting                | Description   | Valid Range        | Default Value |
|---------------------------|---|--------------------|---------------|
| <b>Status</b>             | Enable or disable the cycle rule.   | Enabled / Disabled | Enabled       |
| <b>Day(s) of the Week</b> | Select which days of the week this rule will apply to. You can select multiple days.  | Days of the week   | N/A           |
| <b>Wakeup Start Time</b>  | Specify the hour and minute when the device will leave power-saving mode on the specified <b>Day(s) of the Week</b> . You can also click the clock icon to select the time from a drop-down list. | Time               | 12:00 AM      |

| UI Setting             | Description   | Valid Range | Default Value |
|------------------------|---|-------------|---------------|
| <b>Wakeup End Time</b> | Specify the hour and minute when the device will enter power-saving mode on the specified <b>Day(s) of the Week</b> . You can also click the clock icon to select the time from a drop-down list. | Time        | 12:15 AM      |
| <b>Start Date</b>      | Specify when this cycle rule will take effect.  | Date        | N/A           |
| <b>End Date</b>        | Specify when this cycle rule will end.  | Date        | N/A           |

### Add Cycle Rule - Monthly

If the **Cycle Type** is set to **Monthly**, these options will appear.

| UI Setting                 | Description   | Valid Range   | Default Value |
|----------------------------|---|---|---------------|
| <b>Status</b>              | Enable or disable the cycle rule.   | Enabled / Disabled                                    | Enabled       |
| <b>Day(s) of the Month</b> | Select which days of the month this rule will apply to. You can select multiple days by entering a comma in between each day (e.g., 1,2,16). If a month does not have a specified day in it, the rule will be ignored for that day. | 1 to 31, multiple days should be separated by a comma | N/A           |
| <b>Wakeup Start Time</b>   | Specify the hour and minute when the device will leave power-saving mode on the specified <b>Day(s) of the Month</b> . You can also click the clock icon to select the time from a drop-down list.                                  | Time  | 12:00 AM      |
| <b>Wakeup End Time</b>     | Specify the hour and minute when the device will enter power-saving mode on the specified <b>Day(s) of the Month</b> . You can also click the clock icon to select the time from a drop-down list.                                  | Time  | 12:15 AM      |
| <b>Start Date</b>          | Specify when this cycle rule will take effect.  | Date  | N/A           |

| UI Setting      | Description                            | Valid Range | Default Value |
|-----------------|--|-------------|---------------|
| <b>End Date</b> | Specify when this cycle rule will end. | Date        | N/A           |

## Delete Cycle Rule

### Menu Path: System > Power Management - Scheduling

You can delete a cycle rule by using the checkboxes to select the cycle rules you want to delete, then clicking the **Delete** (  ) icon.

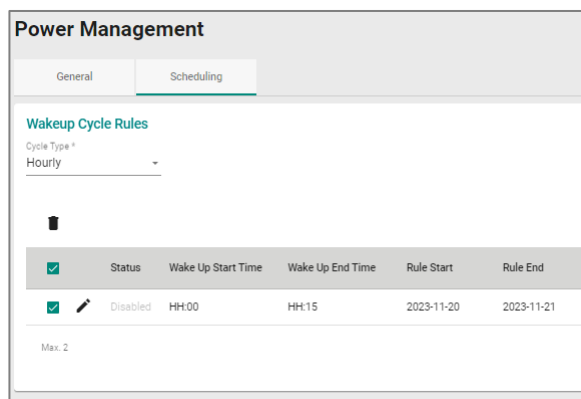

## One Time Rule List

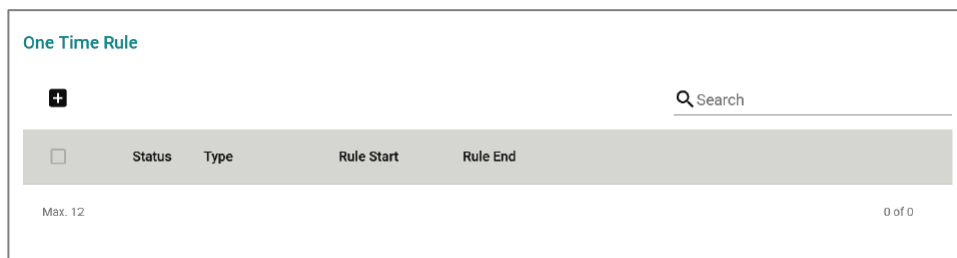

| UI Setting    | Description   |
|---------------|---|
| <b>Status</b> | Shows the status of the one-time rule.  |
| <b>Type</b>   | Shows the type of the one-time rule.<br><b>Power Saving:</b> The device will enter power-saving mode during the specified period.<br><b>Wake Up:</b> The device will leave power-saving mode during the specified period. |

| UI Setting        | Description                |
|-------------------|----------------------------|
| <b>Rule Start</b> | Shows the rule start date. |
| <b>Rule End</b>   | Shows the rule end date.   |

## Add One-time Rule

### Menu Path: System > Power Management - Scheduling

Clicking the **Add (+)** icon in the **One Time Rule** list on the **System > Power Management - Scheduling** page will open this dialog box. This dialog lets you create a new one-time rule.

Click **CREATE** to save your changes and add the new rule.

| UI Setting        | Description   | Valid Range            | Default Value |
|-------------------|---|------------------------|---------------|
| <b>Status</b>     | Enable or disable the one-time rule.  | Enabled / Disabled     | Enabled       |
| <b>Type</b>       | Select the type for the one-time rule.<br><b>Power Saving:</b> The device will enter power-saving mode during the specified period.<br><b>Wake Up:</b> The device will leave power-saving mode during the specified period. This requires an active cycle rule. | Power Saving / Wake up | Power Saving  |
| <b>Start Date</b> | Specify the date this one-time rule will take effect.   | Date                   | N/A           |
| <b>Start Time</b> | Specify the time this one-time rule will take effect.   | Time                   | N/A           |
| <b>End Date</b>   | Specify the date this one-time rule will end.   | Date                   | N/A           |



| UI Setting      | Description                                   | Valid Range | Default Value |
|-----------------|---|-------------|---------------|
| <b>End Time</b> | Specify the time this one-time rule will end. | Time        | N/A           |

## Delete One-time Rule

### Menu Path: System > Power Management - Scheduling

You can delete a one-time rule by using the checkboxes to select the one-time rules you want to delete, then clicking the **Delete (🗑)** icon.

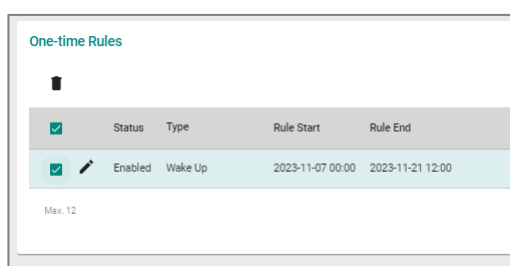

## Power Management - Ignition

### Menu Path: System > Power Management - Ignition

#### Note

The Ignition feature is only applicable to OnCell G4302 hardware rev 1.1 and higher.

This page lets you enable the Ignition feature, which lets you use the digital input to determine when the device should enter and leave power-saving mode. This allows the device to enter and leave power saving modes when a vehicle starts or turns off. The device detects the ignition status through the digital input, and the device will enter power saving mode when the vehicle ignition is off to save battery power.

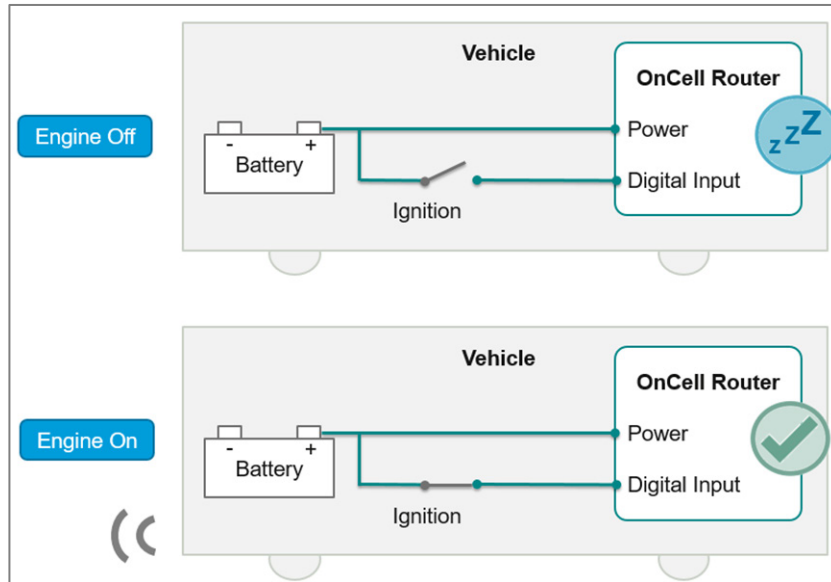

This feature can also use on fixed installations with an I/O to monitor an external device such as a motion sensor. You can configure the I/O line to wake the device or put the device in power saving mode.

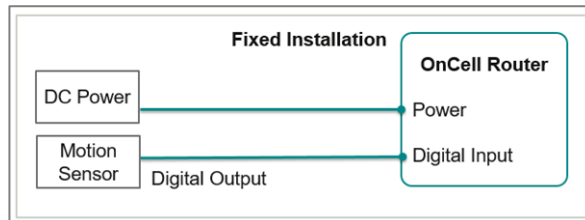

| General                 | Scheduling | Ignition |
|-------------------------|------------|----------|
| Wakeup DI Status *      |            |          |
| Low                     |            |          |
| DI Sensing Time         |            |          |
| 5                       |            |          |
| 5 - 3600 sec.           |            |          |
| Power Saving Delay Time |            |          |
| 15                      |            |          |
| 0 - 15 min.             |            |          |
| <b>APPLY</b>            |            |          |

| UI Setting                     | Description   | Valid Range | Default Value |
|--------------------------------|---|-------------|---------------|
| <b>Wakeup DI Status</b>        | Select the DI status when waking up the device.<br><b>High:</b> The device will leave power saving mode when it detects the DI high and enters power saving mode when it detects DI is low.<br><b>Low:</b> The device will leave power saving mode when it detects the DI is low and enters power saving mode when it detects DI is high. | High / Low  | High          |
| <b>DI Sensing Time</b>         | Enter the number of seconds the DI status must remain changed for before the device determines there is a change in DI status. This is useful for avoiding erratic behavior when the DI signal is unstable.   | 5-3600      | 5             |
| <b>Power Saving Delay Time</b> | Enter the number of minutes to delay entering enter power saving mode after the vehicle's ignition shuts off. This is useful if you want to maintain a network connection while the vehicle's engine is off for a short period of time.   | 0-15        | 15            |

## SMS

### Menu Path: System > SMS

This page allows you to configure your device's SMS settings.

When a cellular connection is not available or if there is limited service, SMS provides an emergency recovery mechanism and a way for performing out-of-band management. The remote SMS control feature helps you get the current cellular status of the device, re-establish the cellular connection, and restart the system by sending specific SMS messages to the device. To ensure the security of out-of-band communication, the SMS function supports password protection and trusted number authentication. With wireless out-of-band management, engineers can control and troubleshoot remote devices, avoiding costly onsite visits by service technicians and minimizing service downtime.

#### Note

Availability of this feature may vary depending on your product model and version.

**Note**

When sending remote control SMS messages, wait 30 seconds between each message to ensure optimal system stability.

This settings area includes these sections:

- General
- Remote Control List
- Send SMS

## SMS - General

**Menu Path:** System > SMS - General

This page lets you configure basic SMS settings and the trusted number list.

**Limitations**

You can add up to 4 trusted numbers.

## SMS Settings

The screenshot shows the 'SMS' settings page with three tabs: 'General', 'Remote Control List', and 'Send SMS'. The 'General' tab is active. It contains two main settings:

- SMS Remote Control \***: A dropdown menu set to 'Enabled', a 'Password' field with a visibility icon and a character count '0 / 15', and a notification bell icon.
- Trusted Number Authentication \***: A dropdown menu set to 'Enabled'.

An 'APPLY' button is located at the bottom left of the settings area.

| UI Setting                           | Description  | Valid Range        | Default Value |
|--------------------------------------|--|--------------------|---------------|
| <b>SMS Remote Control</b>            | Enable or disable SMS remote control. If enabled, the device can be controlled remotely through specific SMS messages.<br><br><div style="border: 1px solid #ccc; background-color: #f9f9f9; padding: 5px; margin-top: 10px;"> <p> <b>Note</b><br/>The cellular module must be enabled for this feature. Refer to <a href="#">Cellular</a> for more information.</p> </div> | Enabled / Disabled | Enabled       |
| <b>Password</b>                      | Specify the required password in SMS remote control message format: @password@command  | 0 to 15 characters | N/A           |
| <b>Trusted Number Authentication</b> | Enable or disable trusted number authentication. If enabled, the device will only accept SMS messages from numbers added to the Trusted Numbers List. If disabled, the device can be controlled by messages sent from any number. Refer to Add Trusted Number Entry.   | Enabled / Disabled | Enabled       |

## Trusted Number List

Trusted Number List



|                          | Name | Country Code | Number |
|--------------------------|------|--------------|--------|
| <input type="checkbox"/> |      |              |        |

Max. 4
0 of 0

| UI Setting          | Description   |
|---------------------|---|
| <b>Name</b>         | Shows the name used to identify the trusted number. |
| <b>Country Code</b> | Shows the country code for the trusted number.      |
| <b>Number</b>       | Shows the trusted number.                           |

## Add Trusted Number Entry

Clicking the **Add** () icon on the **SMS > General > Trusted Number List** will open this dialog box. This dialog lets you create a new trusted number list. Click **CREATE** to save your changes and add the new trusted number.

### Add Trusted Number Entry

Name \*  0 / 15

+ Country Code \*  Number \*

CANCEL APPLY

| UI Setting          | Description   | Valid Range        | Default Value |
|---------------------|---|--------------------|---------------|
| <b>Name</b>         | Specify a name to help identify the number. This is for reference only. | 1 to 15 characters | N/A           |
| <b>Country Code</b> | Specify the country code of the number.                                 | Valid country code | N/A           |
| <b>Number</b>       | Enter the phone number.   | Valid phone number | Enabled       |

## Edit Trusted Number Entry

Clicking the **Edit (✎)** icon for an account on the **SMS > General > Trusted Number List** will open this dialog box. This dialog lets you edit an existing trusted number list. Click **APPLY** to save your changes.

### Trusted Number List

+
🔍 Search

|                          | Name     | Country Code | Number     |
|--------------------------|----------|--------------|------------|
| <input type="checkbox"/> | ✎ Moxa 1 | 886          | 0911111111 |
| <input type="checkbox"/> | ✎ Moxa 2 | 886          | 0912222222 |
| <input type="checkbox"/> | ✎ Moxa 3 | 886          | 0913333333 |
| <input type="checkbox"/> | ✎ Moxa 4 | 886          | 0914444444 |

Max. 4

### Edit Trusted Number Entry

Name\*  
Moxa 1 6 / 15

---

Country Code\*      Number\*  
+ 886                      0911111111

CANCEL      APPLY

| UI Setting          | Description   | Valid Range        | Default Value |
|---------------------|---|--------------------|---------------|
| <b>Name</b>         | Specify a name to help identify the number. This is for reference only. | 1 to 15 characters | N/A           |
| <b>Country Code</b> | Specify the country code of the number.                                 | Country code       | N/A           |
| <b>Number</b>       | Enter the phone number.   | Phone number       | Enabled       |

## Delete Trusted Number Entry

You can delete trusted numbers by using the checkboxes to select the ones you want to delete, then clicking the **Delete (🗑)** icon.

### Trusted Number List

🗑

|                                     | Name                 | Country Code | Number   |
|-------------------------------------|----------------------|--------------|----------|
| <input checked="" type="checkbox"/> | <span>✎</span> moxa1 | 123          | 12345678 |

Max. 4

## Remote Control List

This page lets you manage the remote control commands your device will respond to.

## Remote Control List Settings

### SMS

General
Remote Control List
Send SMS

SMS Receipt \*  
Enabled ▼ i Device will send a reply SMS to the sender after device receive the SMS

APPLY

| UI Setting         | Description   | Valid Range        | Default Value |
|--------------------|---|--------------------|---------------|
| <b>SMS Receipt</b> | Enable or disable SMS receipts. If enabled, the device will send a confirmation SMS when receiving a command SMS. | Enabled / Disabled | Enabled       |

## Remote Control Command List

Use the toggle buttons to enable or disable the corresponding SMS command. Alternatively, check the boxes of the commands you want to manage and use the Quick Setting ( ) icon to enable or disable the selected commands in bulk. Refer to the table below for an overview of each command.

Search

|                                     | Action   | Command                  |
|-------------------------------------|--|--------------------------|
| <input checked="" type="checkbox"/> | <input type="checkbox"/> System Restart            | @password@restart        |
| <input type="checkbox"/>            | <input type="checkbox"/> Cellular Report           | @password@cell.report    |
| <input type="checkbox"/>            | <input type="checkbox"/> Cellular Start Connecting | @password@cellular.start |
| <input type="checkbox"/>            | <input type="checkbox"/> Cellular Stop Connecting  | @password@cellular.stop  |
| <input type="checkbox"/>            | <input type="checkbox"/> Switch SIM                | @password@switchsim      |
| <input type="checkbox"/>            | <input type="checkbox"/> Start IPsec Tunnel        | @password@ipsec.start    |
| <input type="checkbox"/>            | <input type="checkbox"/> Stop IPsec Tunnel         | @password@ipsec.stop     |
| <input type="checkbox"/>            | <input type="checkbox"/> Set DO On                 | @password@do.on          |
| <input type="checkbox"/>            | <input type="checkbox"/> Set DO Off                | @password@do.off         |



| Action                           | Command                  | Description   |
|----------------------------------|--------------------------|---|
| <b>System Restart</b>            | @password@restart        | The device will reboot.   |
| <b>Cellular Report</b>           | @password@cell.report    | The device will reply with an SMS message containing the current cellular status of the device.   |
| <b>Cellular Start Connecting</b> | @password@cellular.start | The device will enable the cellular data connection.  |
| <b>Cellular Stop Connecting</b>  | @password@cellular.stop  | The device will disable the cellular data connection.   |
| <b>Switch SIM</b>                | @password@switchsim      | The device will restart the cellular module and use the SIM card installed in the other SIM slot. |
| <b>Start IPsec Tunnel</b>        | @password@ipsec.start    | The device will establish an IPsec tunnel.  |
| <b>Stop IPsec Tunnel</b>         | @password@ipsec.stop     | The device will disconnect the IPsec tunnel.  |
| <b>Set DO On</b>                 | @password@do.on          | The device will set the status of the relay output to On.   |
| <b>Set DO Off</b>                | @password@do.off         | The device will set the status of the relay output to Off.  |

## Send SMS

This page lets you send a custom SMS message from the device to a specified recipient, which can be useful for testing the device's SMS connection. Click **SEND** to send the SMS message.

The screenshot shows a web interface titled "SMS" with three tabs: "General", "Remote Control List", and "Send SMS". The "Send SMS" tab is active. Below the tabs, there is a "Send SMS" section with the following fields:

- Two input fields: "+ Country Code \*" and "Number \*".
- A text area for "SMS Message \*" with a character count of "0/160".
- A small icon of a pencil in the bottom right corner of the text area.
- A note below the text area: "Special characters such as \*, \, |, ~, !, (, ) require two bytes".
- A green "SEND" button at the bottom left.

| UI Setting          | Description  | Valid Range         | Default Value |
|---------------------|--|---------------------|---------------|
| <b>Country Code</b> | Specify the country code for the recipient's number. | Valid country code  | N/A           |
| <b>Number</b>       | Specify the recipient's phone number.                | Valid phone number  | N/A           |
| <b>Message</b>      | Specify the text of the message to send.             | 0 to 160 characters | N/A           |

## GNSS

### Menu Path: System > GNSS

These pages let you configure the GNSS settings of your device.

#### Note

Availability of this feature may vary depending on your product model and version.

This page includes these tabs:

- General
- GNSS Client
- GNSS Server
- Status

## GNSS - General

### Menu Path: System > GNSS - General

This page lets you enable or disable GNSS functionality.

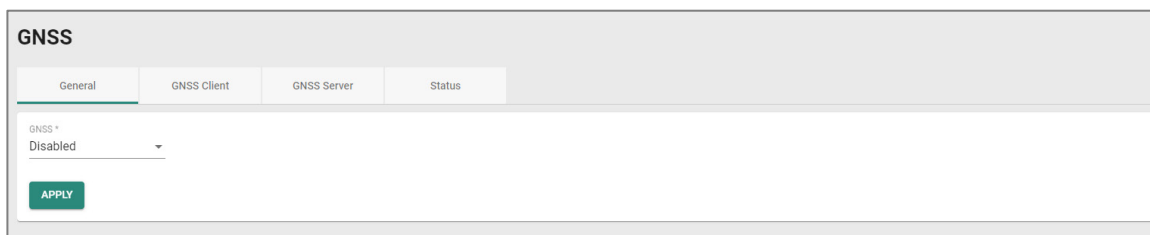

| UI Setting  | Description   | Valid Range        | Default Value |
|---|---|--------------------|---------------|
| <b>GNSS</b>   | Enable or disable GNSS functionality. If enabled, the device will use satellite positioning to show its real-time physical location on a map. | Enabled / Disabled | Enabled       |
| <p><b>Note</b></p> <p>The cellular module must be enabled for this feature. Refer to <a href="#">Cellular</a> for more information.</p> |   |                    |               |

## GNSS Client

**Menu Path:** System > GNSS - GNSS Client

This page lets you configure GNSS Client settings to allow the device to send GNSS data to a user-configured server.

| UI Setting         | Description   | Valid Range        | Default Value |
|--------------------|---|--------------------|---------------|
| <b>GNSS Client</b> | Enable or disable GNSS Client functionality. If enabled, the device will send GNSS data to the configured server at a specified interval. | Enabled / Disabled | Disabled      |

| UI Setting             | Description  | Valid Range            | Default Value |
|------------------------|--|------------------------|---------------|
| <b>Report Protocol</b> | Select the report protocol to use.<br><b>TCP:</b> Send reports over TCP. This requires a receipt from the server to confirm the data was delivered.<br><b>UDP:</b> Send reports over UDP. This does not require a receipt from the server. | TCP / UDP              | TCP           |
| <b>Host Address</b>    | Specify the IP address or host name of the server that will receive the GNSS data.   | IP address / host name | N/A           |
| <b>Host Port</b>       | Specify the TCP or UDP port number of the server that will receive the GNSS data.  | 1 to 65535             | 8919          |
| <b>Report Period</b>   | Specify the interval (in seconds) at which GNSS data reports are generated.  | 10 to 86400            | 30            |
| <b>Report Format</b>   | Select the report format to use.<br><b>NMEA:</b> Send GNSS data in standard NMEA format.<br><b>General:</b> Send GNSS data in latitude-longitude format.   | NMEA / General         | NMEA          |
| <b>Report ID</b>       | Enter the ID to use in the GNSS data report header. The Report ID and device MAC address will be included in both report formats.  | 1 to 15 characters     | N/A           |

## GNSS Server

### Menu Path: System > GNSS - GNSS Server

This page lets you configure the the device to act as a GNSS Server to allow clients to request GNSS data reports.

The screenshot shows the GNSS configuration interface with the following settings:

- GNSS Server:** Disabled (indicated by a red 'i' icon)
- Server Port:** 8919 (range: 1 - 65535)
- Report Period:** 30 (range: 10 - 86400 sec.)
- Report Format:** NMEA
- Report ID:** 0 / 15

An **APPLY** button is located at the bottom left of the configuration area.

| UI Setting           | Description   | Valid Range        | Default Value |
|----------------------|---|--------------------|---------------|
| <b>GNSS Server</b>   | Enable or disable GNSS Server functionality. If enabled, clients will be able to request GNSS data reports from this server.                      | Enabled / Disabled | Disabled      |
| <b>Server Port</b>   | Specify the UDP port number for clients to access the server.   | 1 to 65535         | 8919          |
| <b>Report Period</b> | Specify the interval in seconds at which GNSS data reports are generated.   | 10 to 86400        | 30            |
| <b>Report Format</b> | Select the report format.<br><b>NMEA:</b> Send GNSS data in standard NMEA format.<br><b>General:</b> Send GNSS data in latitude-longitude format. | NMEA / General     | NMEA          |
| <b>Report ID</b>     | Enter the ID to use in the GNSS data report header. The Report ID and device MAC address will be included in both report formats.                 | 1 to 15 characters | N/A           |

## Status





### Menu Path: System > GNSS - Status

The Status screen shows the current geolocational information of the device, as well the device's current physical location on an interactive map.

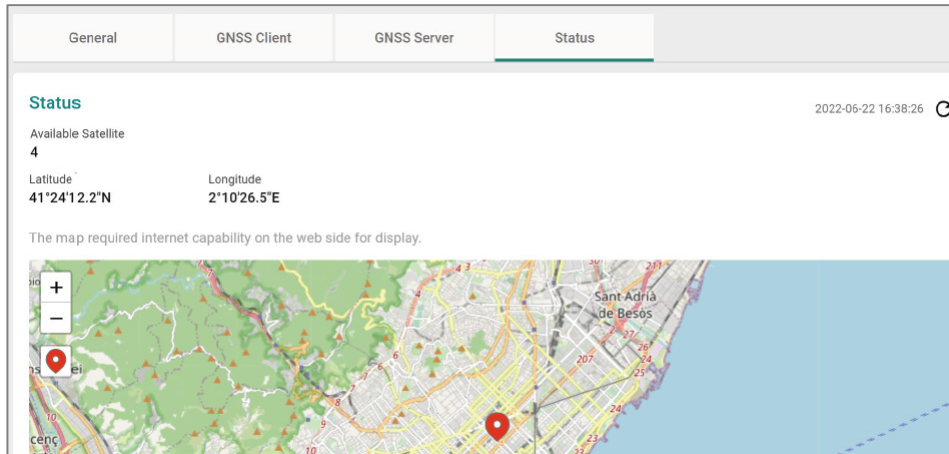
**Note**

The device's physical location and coordinates will only appear if GNSS is enabled.



| UI Setting  | Description  |
|---|--|
| <b>Available Satellite</b>  | Shows number of satellites the device is receiving information from. |
| <b>Latitude</b>   | Shows the north-south position of the device.                        |
| <b>Longitude</b>  | Shows the east-west position of the device.                          |
|  | Click to refresh the coordinate data.                                |
|  | Click to zoom in or zoom out on the map.                             |
|  |  |
|  | Click to center the map on the device's location.                    |

## Setting Check

### Menu Path: System > Setting Check

This page provides a double confirmation mechanism that allows you to verify configuration changes made by remote users before they are applied.

Setting Check is available for the following configuration settings:

- Layer 3 -7 Policy
- Network Address Translate
- Trusted Access

### Setting Check

Setting Check Configuration

Layer 3-7 Policy

Network Address Translate

Trusted Access

Timer \*  
  
10 - 3600 sec.

APPLY

| UI Setting   | Description   | Valid Range        | Default Value |
|--|---|--------------------|---------------|
| <b>Layer 3-7 Policy</b>  | Enable or disable Setting Check for Layer 3 - 7 policy changes. | Enabled / Disabled | Disabled      |
| <b>Network Address Translate</b>   | Enable or disable Setting Check for NAT policy changes.         | Enabled / Disabled | Disabled      |
| <b>Trusted Access</b>  | Enable or disable Setting Check for Trusted IP address changes. | Enabled / Disabled | Disabled      |
| <b>Timer</b>   | Set the time (in seconds) the user has to confirm the changes.  | 10 to 3600         | 180           |
| <p><b>Note</b></p> <p>If the user does not confirm the changes within the specified time period, the system will automatically undo the changes.</p> |   |                    |               |

# Cellular

## Menu Path: Cellular

This page lets you configure mobile network connection settings.

This page includes these tabs:

- General
- SIM Settings
- GuaranLink
- Status

### Note

These features are only available on devices with cellular capabilities.

## Cellular - User Privileges

Privileges to Cellular settings are granted to the different authority levels as follows.

Refer to [System > Account Management > User Accounts](#) for more information on user accounts.

| Settings | Admin | Supervisor | User |
|----------|-------|------------|------|
| Cellular | R/W   | R/W        | R    |

## Cellular - General

### Menu Path: Cellular - General

This page lets you configure basic cellular settings for your device. Click **APPLY** to save your changes.



### Cellular

General
SIM Settings
GuaranLink
Status

Cellular Module \*

Enabled ▼

Cellular Operation Mode

Router ▼

Cellular Data Connection \*

Enabled ▼

MTU \*

1428

576 - 1500 bytes

APPLY

| UI Setting                      | Description  | Valid Range        | Default Value |
|---------------------------------|--|--------------------|---------------|
| <b>Cellular Module</b>          | Enable or disable the cellular module for establishing cellular connections, sending SMS messages, and using GNSS services.  | Enabled / Disabled | Enabled       |
| <b>Cellular Operation Mode</b>  | The device will function as an IP router for IP data communication.  | Router             | Router        |
| <b>Cellular Data Connection</b> | Enable or disable cellular data connections. If enabled, cellular connections may incur data usage costs based on your cellular service and ISP.   | Enabled / Disabled | Enabled       |
| <b>MTU</b>                      | Specify the Maximum Transmission Unit (MTU) value for router mode. The recommended MTU size may vary depending on the cellular carrier. Make sure the end device is set to the same MTU value for optimal performance. | 576 to 1500        | 1428          |



## SIM Settings

### Menu Path: Cellular - SIM Settings

This section lets you enable or disable SIM cards and manage the SIM card settings including the priority, cellular bands, and authentication method.

### Reordering SIM Card Priority





The device will always connect to the Internet using the SIM card designated with priority 1. The secondary SIM card will act as a redundant backup. To change the priority of the

SIM cards, click the **Reorder Priorities** (  ) icon then click and drag the SIM card to the desired priority. Click the **Finish Reorder** (  ) icon to confirm the change.

## Changing the Active SIM Card

The green dot icon indicates the SIM card is active and connected to the Internet. By default, the SIM card designated with priority 1 will be used to connect to the Internet while the SIM with priority 2 acts as a backup. If necessary, you can manually change the active SIM card. Click the **Change SIM** (  ) icon to swap the active SIM card.

## SIM Card List

| Cellular  |          |                                     |         |                |            |          |                |            |
|---|----------|-------------------------------------|---------|----------------|------------|----------|----------------|------------|
| General   |          | SIM Settings                        |         |                | GuaranLink |          | Status         |            |
|    |          | <input type="text" value="Search"/> |         |                |            |          |                |            |
| SIM   | Priority | Status                              | Carrier | Cellular Bands | APN        | Username | Authentication |            |
|   | 1        | 1                                   | Enabled | Generic        | Auto       |          | Auto           |            |
|   | 2        | 2                                   | Enabled | Generic        | Auto       |          | Auto           |            |
|   |          |                                     |         |                |            |          |                | 1 - 2 of 2 |

| UI Setting            | Description                                       |
|-----------------------|---|
| <b>SIM</b>            | Shows which SIM slot the entry is for.            |
| <b>Priority</b>       | Shows the priority of the SIM card.               |
| <b>Status</b>         | Shows the configured status of the SIM card.      |
| <b>Carrier</b>        | Shows the carrier for the SIM card.               |
| <b>Cellular Bands</b> | Shows the cellular bands the SIM card will use.   |
| <b>APN</b>            | Shows the access point network (APN) information. |
| <b>Username</b>       | Shows the username for PAP authentication.        |
| <b>Authentication</b> | Shows the authentication method.                  |

## Edit SIM Settings

### Menu Path: Cellular - SIM Card Settings

Clicking the **Edit** (✎) icon for an entry on the **Cellular - SIM Card Settings** page will open this dialog box. This dialog lets you edit the settings for the SIM card. Click **APPLY** to save your changes.

The screenshot shows a dialog box titled "Edit SIM 1 Settings". It contains the following fields and options:

- Status \*: Enabled (dropdown)
- Carrier \*: Generic (dropdown)
- Cellular Band Mode \*: Manual (dropdown)
- Cellular Bands \*: 2G, 3G, 4G (dropdown)
- APN: 0 / 40 (text input)
- Authentication \*: Auto (dropdown)
- A "CHANGE PIN" link is located next to the APN field.
- Buttons for "CANCEL" and "APPLY" are at the bottom right.

| UI Setting  | Description   | Valid Range        | Default Value |
|---|---|--------------------|---------------|
| <b>Status</b>   | Enable or disable the SIM card.   | Enabled / Disabled | Enabled       |
| <b>Carrier</b>  | Select the carrier to use with the SIM card.  | Generic            | Generic       |
| <b>Cellular Band Type</b>                                 | Select the cellular band type.<br><b>Auto:</b> The device will automatically negotiate the optimal cellular band frequency to use with the base station.<br><b>Manual:</b> Manually specify the cellular band frequencies to use. | Auto / Manual      | Auto          |
| <b>Cellular Bands (Only when Cellular Band is Manual)</b> | Select the cellular band manually.  | Checkbox           | N/A           |
| <b>APN</b>  | Specify the access point network (APN) information provided by your cellular carrier if they require it.  | 0 to 40 characters | N/A           |

| UI Setting   | Description   | Valid Range        | Default Value |
|--|---|--------------------|---------------|
| <b>PIN</b>   | <p>Enter the PIN number to unlock the SIM card.</p> <div style="background-color: #f0f0f0; padding: 5px; margin-top: 10px;"> <p><b>Note</b></p> <p>If you have already set up a PIN code, click <b>CHANGE PIN</b> to change the PIN.</p> </div>   | 0 to 8 characters  | N/A           |
| <b>Authentication</b>  | <p>Select the authentication method for the SIM card.</p> <p><b>Auto:</b> Set up a session without specifying the authentication method.</p> <p><b>PAP:</b> Use PAP (Password Authentication Protocol) authentication. PAP will send the username and password to the server for authentication against the server's database.</p> <p><b>CHAP:</b> Use CHAP (Challenge-Handshake Authentication Protocol) authentication. CHAP will generate a password which is changed frequently for improved identity security.</p> | Auto / PAP / CHAP  | Auto          |
| <b>Username</b><br>(Only when Authentication is PAP or CHAP) | Specify the username for PAP or CHAP authentication.  | 0 to 32 characters | N/A           |
| <b>Password</b><br>(Only when Authentication is PAP or CHAP) | Specify the password for PAP or CHAP authentication.  | 0 to 32 characters | N/A           |

## GuaranLink

### Menu Path: Cellular - GuaranLink

This page lets you set up Moxa's GuaranLink feature, which enables reliable connectivity with 3 different connection checks and 4 levels of recovery actions. A number of factors can contribute to connection failures in cellular communications, including loss of cellular signal, interference, connection errors caused by the base station, or termination by the operator for unknown reasons. GuaranLink is designed to address various needs, including minimizing cellular costs by optimizing the number of cellular packets sent to check connection status and optimizing the time it takes to swap to a backup SIM.

# GuaranLink Settings

**Cellular**

General   SIM Settings   **GuaranLink**   Status

---

GuaranLink \*  
Enabled ▾

**Connection Alive Check**

Check Timing \*   Ping Interval \*

Always ▾   10

1 - 86400   sec.

Ping Host 1   Ping Host 2   Ping Failure Retry Times \*

8.8.8.8   180.76.76.76   3

IP Address/Domain Name   IP Address/Domain Name   1 - 10   times

**APPLY**

| UI Setting   | Description  | Valid Range                              | Default Value |
|--|--|--|---------------|
| <b>GuaranLink</b>  | <p>Enable or disable GuaranLink. If enabled, the device will monitor cellular connections. If a connection failure is detected, the device will attempt to automatically recover the connection.</p> <div style="border: 1px solid #ccc; padding: 5px; margin-top: 10px;"> <p><b>Note</b></p> <p>Enabling this function will send additional alive check cellular messages, which may incur additional cellular costs.</p> </div>                                | Enabled / Disabled                       | Enabled       |
| <b>Check Time</b>  | <p>Specify the check time.</p> <p><b>Always:</b> The device will constantly send out alive check packets to check for cellular connection issues.</p> <p><b>Idle Transmission:</b> The device will only send alive check packets when the device has not received any data transmissions during the specified Ping Interval period.</p> <p><b>Poor Signal:</b> The device will only send alive check packets when the device identifies poor signal quality.</p> | Always / Idle Transmission / Poor Signal | Always        |
| <b>Ping Interval (Only when Check Time is Always)</b>            | Specify the interval (in seconds) at which the device will send out an alive check packet.   | 1 to 86400 seconds                       | 10            |
| <b>Ping Interval (Only when Check Time is Idle Transmission)</b> | Specify the interval (in minutes) the device will wait for data transmissions. If no data transmissions take place during the interval, the device will perform a connection alive check.  | 1 to 600 minutes                         | 5             |

| UI Setting   | Description  | Valid Range            | Default Value |
|--|--|------------------------|---------------|
| <b>Signal Checking Interval</b><br>(Only when Check Time is Poor Signal) | Specify the interval (in minutes) the device will check the host for poor signal quality. If the device detects poor signal quality from the host, the device will perform a connection alive check.   | 1 to 600 minutes       | 5             |
| <b>Ping Host 1/2</b>   | Enter the IP address or domain name of the remote host to ping. If both ping host 1 and 2 are configured, the device will perform connection alive checks for both hosts simultaneously. The device will only consider the connection to have failed if the device receives no response from both hosts. | IP address/domain name | N/A           |
| <b>Ping Failure Retry Times</b>  | Specify the number of times the device will perform the connection alive check. If the check fails the specified number of retry times, the device will determine that the cellular connection has failed and will initiate the GuaranLink recovery process.   | 1 to 10                | 3             |

## GuaranLink Recovery Settings

| GuaranLink Recovery Settings |                       |            |
|------------------------------|-----------------------|------------|
| Recovery Step                | Recovery Action       | Attempts ↑ |
| 1                            | Cellular Reconnect    | 1          |
| 2                            | ISP Reregister        | 1          |
| 3                            | Cellular Module Reset | 3          |
| 4                            | System Reboot         | 0          |

| UI Setting             | Description   |
|------------------------|---|
| <b>Recovery Step</b>   | Shows the sequence of the recovery step.                |
| <b>Recovery Action</b> | Shows the recovery action.                              |
| <b>Attempts</b>        | Shows the number of times the action will be attempted. |

## Edit Recovery Action Settings

### Menu Path: Cellular - GuaranLink

Clicking the **Edit** (✎) icon for an action on the **Cellular - GuaranLink** page will open this dialog box. This dialog lets you specify the number of times to attempt each recovery action before moving to the next recovery action. Click **APPLY** to save your changes.

### Edit Recovery Action Settings

**Step 1 Cellular Reconnect**  
Attempts \*  
1

**Step 2 ISP Reregister**  
Attempts \*  
1

**Step 3 Cellular Module Reset**  
Attempts \*  
3

**Step 4 System Reboot**  
Attempts \*  
0

**CANCEL** **APPLY**

| UI Setting                                   | Description  | Valid Range | Default Value |
|--|--|-------------|---------------|
| <b>Step 1 Cellular Reconnect Attempts</b>    | <p>Specify the number of times the device will try to disconnect and re-establish the cellular connection.</p> <p>If the connection is not restored after the specified number of attempts, the device will move on to the next recovery step.</p> <p>If set to 0, the device will skip this step and move on to the next recovery step.</p>   | 0 to 5      | 1             |
| <b>Step 2 Re-register Attempts</b>           | <p>Specify the number of times the device will try to re-register with the ISP to obtain a new IP address from the base station to re-establish the cellular connection.</p> <p>If the connection is not restored after the specified number of attempts, the device will move on to the next recovery step.</p> <p>If set to 0, the device will skip this step and move on to the next recovery step.</p> | 0 to 5      | 1             |
| <b>Step 3 Cellular Module Reset Attempts</b> | <p>Specify the number of times the device will try to reset the cellular module to re-establish the cellular connection.</p> <p>If the connection is not restored after the specified number of attempts, the device will move on to the next recovery step.</p> <p>If set to 0, the device will skip this step and move on to the next recovery step.</p>   | 0 to 10     | 3             |



| UI Setting  | Description   | Valid Range | Default Value |
|---|---|-------------|---------------|
| <b>Step 4 System Reboot Attempts</b>  | <p>Specify whether the device will reboot in order to re-establish the cellular connection.</p> <p>If the connection is not restored after rebooting, the device will restart the recovery process from step 1.</p> | 0 to 1      | 0             |
|   |   |             |               |
| <p>If set to 0, the device will not perform a system reboot and will restart the recovery process from step 1.</p>                            |   |             |               |
| <p>If two SIM cards are inserted the device, the device will attempt to use another SIM card to restart the recovery process from step 1.</p> |   |             |               |
|   |   |             |               |

## Cellular - Status

### Menu Path: Cellular - Status

This section lets you see the current status of the cellular connection as well as information about the cellular carrier and SIM card, cellular module, and signal strength.

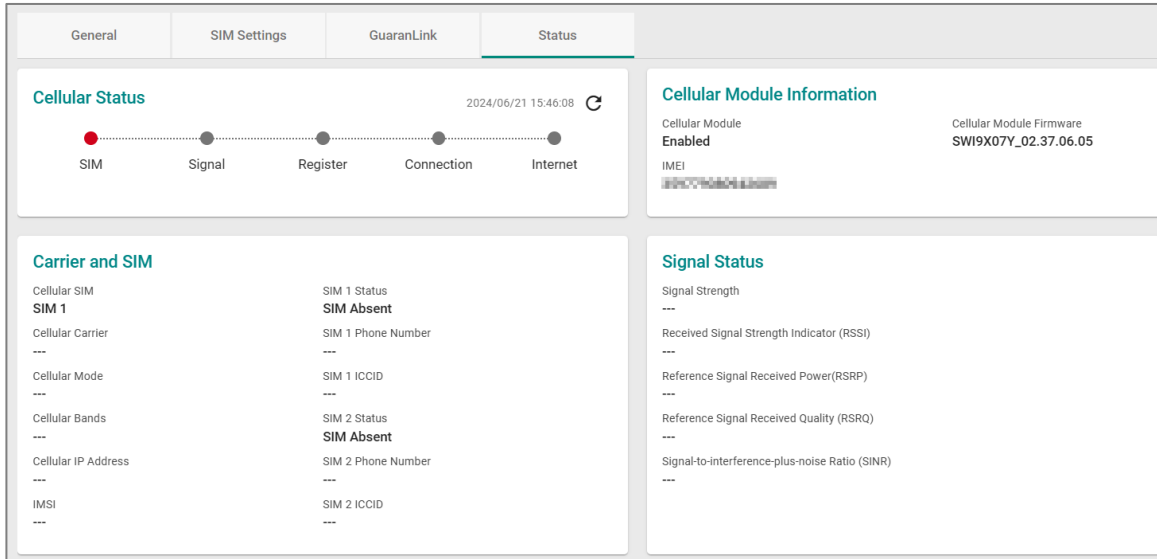

## Cellular Status

This section shows you the cellular connection status of your device.

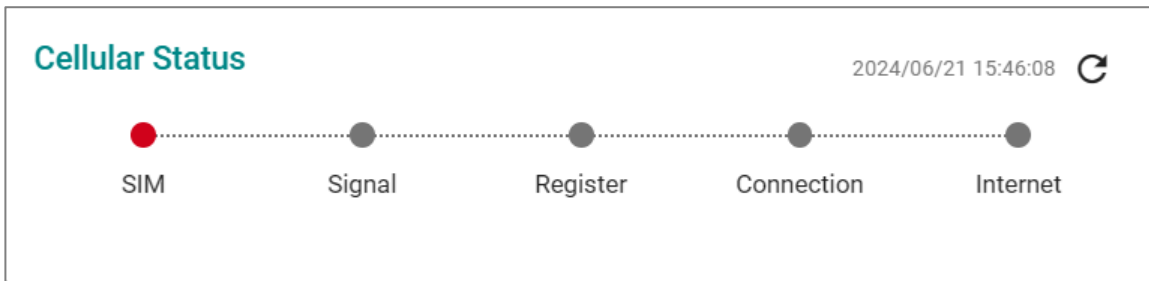

| UI Setting      | Description   |
|-----------------|---|
| <b>SIM</b>      | Shows the status of the SIM card.<br><b>Green:</b> The SIM card is active.<br><b>Red:</b> The SIM card is inactive.<br><b>Gray:</b> No SIM card inserted.   |
| <b>Signal</b>   | Shows the status of the device's cellular signal.<br><b>Green:</b> Good cellular signal.<br><b>Amber:</b> Fair cellular signal.<br><b>Red:</b> Poor cellular signal.<br><b>Gray:</b> No cellular signal.  |
| <b>Register</b> | Shows the status of the device's cellular registration.<br><b>Green:</b> The device successfully registered with the base station.<br><b>Red:</b> The device failed to register with the base station.<br><b>Gray:</b> The registration phase has not been reached yet. |

| UI Setting  | Description   |
|---|---|
| <b>Connection</b>   | Shows the status of the device's network connection.<br><b>Green:</b> The device obtained an IP address from the base station.<br><b>Red:</b> The device failed to obtain an IP address from the base station.<br><b>Gray:</b> The connection phase has not been reached yet. |
| <b>Internet</b>   | Shows the status of the device's Internet connection.<br><b>Green:</b> The device is connected to the Internet.<br><b>Red:</b> The device failed to connect to the Internet.<br><b>Gray:</b> Alive checks are not being performed.  |
| <p> <b>Note</b></p> <p>GuaranLink must be enabled to perform connection alive checks. Refer to <a href="#">Cellular - GuaranLink</a> for more information.</p> |   |

## Cellular Module Information

| Cellular Module Information   |                          |
|---|--------------------------|
| Cellular Module   | Cellular Module Firmware |
| Enabled   | SWI9X07Y_02.37.06.05     |
| IMEI  |                          |
|  |                          |

| UI Setting                      | Description   |
|---------------------------------|---|
| <b>Cellular Module</b>          | Shows the current status of the cellular module.  |
| <b>Cellular Module Software</b> | Shows the firmware version of the cellular module.                                      |
| <b>IMEI</b>                     | Shows the International Mobile Equipment Identity (IMEI) number of the cellular module. |

## Carrier and SIM

| Carrier and SIM     |                    |
|---------------------|--------------------|
| Cellular SIM        | SIM 1 Status       |
| <b>SIM 1</b>        | <b>SIM Absent</b>  |
| Cellular Carrier    | SIM 1 Phone Number |
| ---                 | ---                |
| Cellular Mode       | SIM 1 ICCID        |
| ---                 | ---                |
| Cellular Bands      | SIM 2 Status       |
| ---                 | <b>SIM Absent</b>  |
| Cellular IP Address | SIM 2 Phone Number |
| ---                 | ---                |
| IMSI                | SIM 2 ICCID        |
| ---                 | ---                |

| UI Setting                 | Description   |
|----------------------------|---|
| <b>Cellular SIM</b>        | Shows the SIM card used for establishing the cellular connection.         |
| <b>Cellular Carrier</b>    | Shows the cellular service provider being used.                           |
| <b>Cellular Mode</b>       | Shows the cellular connection technology being used, such as LTE or HSPA. |
| <b>Cellular Band</b>       | Shows the cellular band frequency being used.                             |
| <b>Cellular IP Address</b> | Shows the cellular IP address assigned by the cellular carrier.           |
| <b>IMSI</b>                | Shows the International Mobile Subscriber Identity number.                |
| <b>SIM 1 Status</b>        | Shows the status of the SIM card installed in SIM slot 1.                 |
| <b>SIM 1 Phone Number</b>  | Shows the phone number of the SIM card in SIM slot 1.                     |
| <b>SIM 1 ICCID</b>         | Shows the Integrated Circuit Card ID of the SIM card in SIM slot 1.       |
| <b>SIM 2 Status</b>        | Shows the status of the SIM card installed in SIM slot 2.                 |
| <b>SIM 2 Phone Number</b>  | Shows the phone number of the SIM card in SIM slot 2.                     |
| <b>SIM 2 ICCID</b>         | Shows the Integrated Circuit Card ID of the SIM card in SIM slot 2.       |

# Signal Status

**Signal Status**

Signal Strength  
---

Received Signal Strength Indicator (RSSI)  
---

Reference Signal Received Power(RSRP)  
---

Reference Signal Received Quality (RSRQ)  
---

Signal-to-interference-plus-noise Ratio (SINR)  
---

| UI Setting   | Description  |
|--|--|
| <b>Signal Strength</b>                               | Shows the current overall signal strength of the device.   |
| <b>RSRP (Reference Signal Received Power)</b>        | Shows the current RSRP.<br><b>Good:</b> Higher than -80 dBm<br><b>Average:</b> -80 to -90 dBm<br><b>Poor:</b> -90 to -100 dBm<br><b>Inadequate:</b> Less than -100 dBm |
| <b>RSSI (Received Signal Strength Indicator)</b>     | Shows the current RSSI.<br><b>Good:</b> Higher than -73 dBm<br><b>Average:</b> -73 to -89 dBm<br><b>Poor:</b> -89 to -113 dBm<br><b>Inadequate:</b> Less than -113 dBm |
| <b>RSRQ (Reference Signal Received Quality)</b>      | Shows the current RSRQ.<br><b>Good:</b> Higher than -10 dB<br><b>Average:</b> -10 to -15 dB<br><b>Poor:</b> -15 to -20 dB<br><b>Inadequate:</b> Less than -20 dB       |
| <b>SINR (Signal to Interference and Noise Ratio)</b> | Shows the current SINR.<br><b>Good:</b> Higher than 20 dB<br><b>Average:</b> 13 to 20 dB<br><b>Poor:</b> 0 to 13 dB<br><b>Inadequate:</b> Less than 0 dB               |

# Serial

## Menu Path: Serial

This page lets you configure your device's serial settings.

### Note

Availability of this feature may vary depending on your product model and version.

This page includes these tabs:

- Port Settings
- Operation Mode
- Data Packing
- Status
- Serial Data Logs

## Serial - User Privileges

Privileges to Serial settings are granted to the different authority levels as follows. Refer to [System > Account Management > User Accounts](#) for more information on user accounts.

| Settings | Admin | Supervisor | User |
|----------|-------|------------|------|
| Serial   | R/W   | R/W        | R    |

## Serial - Port Settings

### Menu Path: Serial - Port Settings

This page lets you enable or disable the serial port and configure the serial communication parameters. When enabled, the device allows for traditional serial (RS-232/422/485) devices to transmit data over the cellular network.

**Note**

The serial port settings on the device should match the parameters configured for the connected serial device. Refer to your serial device's user manual to determine the appropriate serial communication parameters.

|                  |          |   |
|------------------|----------|---|
| Serial Port *    | Disabled | ▼ |
| Interface Type * | RS-232   | ▼ |
| Baudrate *       | 115200   | ▼ |
| Data Bits *      | 8        | ▼ |
| Stop Bits *      | 1        | ▼ |
| Parity *         | None     | ▼ |
| Flow Control *   | RTS, CTS | ▼ |

| UI Setting            | Description   | Valid Range                                    | Default Value |
|-----------------------|---|--|---------------|
| <b>Serial Port</b>    | Enable or disable the serial port.                                | Enabled / Disabled                             | Disabled      |
| <b>Interface Type</b> | Select the serial interface type to use for the serial device.    | RS-232 / RS-422 / 2-wire-RS-485/ 2-wire-RS-485 | RS-232        |
| <b>Baud Rate</b>      | Specify the data transmission rate to and from the serial device. | 300 to 921600                                  | 115200        |
| <b>Data Bits</b>      | Specify the size for data characters.                             | 5 to 8   | 8             |

| UI Setting          | Description   | Valid Range                         | Default Value |
|---------------------|---|-------------------------------------|---------------|
| <b>Stop Bits</b>    | Specify the size for stop characters.   | 1 to 2                              | 1             |
| <b>Parity</b>       | Select the parity mode. Even and odd parity provide rudimentary error-checking. Space and mark parity are rarely used.  | None / Even / Odd / Space / Mark    | None          |
| <b>Flow Control</b> | Select the flow control method. This determines how the system will suspend and resume data transmissions to prevent data loss. RTS/CTS (hardware) flow control is recommended. | None / RTS/CTS / DTR/DSR / Xon/Xoff | RTS/CTS       |

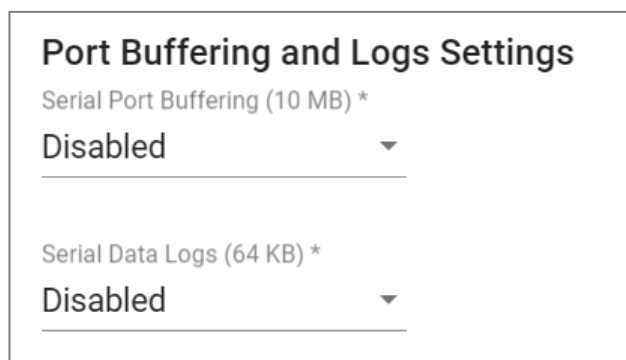

## Port Buffering and Logs Settings

| UI Setting                   | Description  | Valid Range        | Default Value |
|------------------------------|--|--------------------|---------------|
| <b>Serial Port Buffering</b> | <p>Enable or disable serial port buffering. When enabled, if the WAN connection goes down, the router will keep the serial data and retransmit the buffered data when the WAN connection is back. If disabled, serial data will be lost if the WAN connection goes down.</p> <div style="background-color: #f0f0f0; padding: 10px; margin-top: 10px;"> <p><b>Note</b></p> <ul style="list-style-type: none"> <li>• Port buffering can be used in Real COM, RFC2217, TCP Server, and TCP Client modes.</li> <li>• For other modes, the port buffering settings will have no effect.</li> <li>• The maximum buffer size is 10 MB.</li> <li>• Buffer data exceeding 10 MB will overwrite previous data.</li> </ul> </div> | Enabled / Disabled | Disabled      |



| UI Setting              | Description   | Valid Range        | Default Value |
|-------------------------|---|--------------------|---------------|
| <b>Serial Data Logs</b> | <p>Enable or disable serial data logs. If enabled, the router will store the serial data logs in the system RAM.</p> <div style="background-color: #f0f0f0; padding: 5px; margin-top: 10px;"> <p><b>Note</b></p> <p>The system RAM can save up to 64 kb of serial data logs. Serial log data will be cleared when the router is powered off.</p> </div> | Enabled / Disabled | Disabled      |

## Operation Mode

### Menu Path: Serial - Operation Mode

This page lets you set up and configure a serial operation mode. Refer to Serial Operation Modes for more information about the different modes.

### Operation Mode - Real COM

If you select **Real COM** as your **Operation Mode**, these settings will appear.

Operation Mode \*  
 Real COM ▼

---

### Connection Settings

TCP Alive Check Interval  
 7

---

1 - 99 min.

Max. Connections  
 1

---

1 - 2 connection

### Connection Down Settings

Set RTS Signal \*      Set DTR Signal \*  
 High ▼      High ▼

---

**APPLY**

## Connection Settings

| UI Setting                      | Description  | Valid Range | Default Value |
|---------------------------------|--|-------------|---------------|
| <b>TCP Alive Check Interval</b> | Specify the interval (in minutes) at which to check if the TCP connection is still alive. If there is no response from the other end of the connection after the specified time, the TCP connection will be terminated. A setting of 0 means the system will keep the TCP connection open and will not send any "keep alive" packets. Disabling this option can help free up device resources. | 1 to 99     | 7             |
| <b>Max. Connections</b>         | Specify the maximum number of simultaneous connections that the port will accept. Up to 2 hosts can simultaneously collect data from the same serial device.   | 1 to 2      | 1             |

## Connection Down Settings

| UI Setting            | Description   | Valid Range | Default Value |
|-----------------------|---|-------------|---------------|
| <b>Set RTS Signal</b> | Select the RTS signal method to use.<br><b>High:</b> The cellular or Ethernet connection status will not affect RTS signals.<br><b>Low:</b> If the cellular or Ethernet connection is lost, RTS signals will change to low. | High / Low  | High          |
| <b>Set DTR Signal</b> | Select the DTR signal method to use.<br><b>High:</b> The cellular or Ethernet connection status will not affect DTR signals.<br><b>Low:</b> If the cellular or Ethernet connection is lost, DTR signals will change to low. | High / Low  | High          |

## Operation Mode - TCP Server

If you select **TCP Server** as your **Operation Mode**, these settings will appear.

Operation Mode \*  
 TCP Server ▼

---

### Connection Settings

TCP Alive Check Interval  
 7  
 1 - 99 min.

Max. Connections  
 1  
 1 - 2 connection

TCP Data Port  
 4001  
 1 - 65535

TCP Command Port  
 966  
 1 - 65535

Serial Port Inactivity Time  
 0  
 0 - 65535 ms

### Connection Down Settings

Set RTS Signal \*  
 High ▼

Set DTR Signal \*  
 High ▼

**APPLY**

## Connection Settings

| UI Setting   | Description   | Valid Range | Default Value |
|--|---|-------------|---------------|
| <b>TCP Alive Check Interval</b>  | Specify the interval (in minutes) at which to check if the TCP connection is still alive. If there is no response from the other end of the connection after the specified time, the TCP connection will be terminated. A setting of 0 means the system will keep the TCP connection open and will not send any "keep alive" packets. | 1 to 99     | 7             |
| <p><b>Note</b><br/>           Disabling this option can help free up device resources.</p> |   |             |               |
| <b>Max. Connections</b>  | Specify the maximum number of simultaneous connections that the port will accept. Up to 2 hosts can simultaneously collect data from the same serial device.  | 1 to 2      | 1             |

| UI Setting                         | Description  | Valid Range | Default Value |
|------------------------------------|--|-------------|---------------|
| <b>TCP Data Port</b>               | Specify the TCP port number for the serial port used to listen to connections and for other devices to contact. To avoid conflicts with well-known TCP ports, the default port is 4001.  | 1 to 65535  | 4001          |
| <b>TCP Command Port</b>            | Specify the TCP port number for MOXA IP-Serial Library commands.<br><br><div style="background-color: #f0f0f0; padding: 10px; border: 1px solid #ccc;"> <p><b>Note</b></p> <p>It is not necessary to reference this port number in your application when using the Moxa IP-Serial Library since the library automatically obtains the number from the device server. Only change this setting if there is a port number conflict with another application or device.</p> </div>  | 1 to 65535  | 9006          |
| <b>Serial Port Inactivity Time</b> | Specify the time limit in milliseconds to keep the connection open if there is no data going to or from the serial device. If there is no activity for the specified time period, the connection will be terminated. A setting of 0 means the system will always keep the TCP connection open regardless of data activity.<br><br>For many applications, this option should be set to 0, as the serial device may be idle for long periods of time.<br><br><div style="background-color: #fff9c4; padding: 10px; border: 1px solid #ccc;"> <p><b>Warning</b></p> <p>Serial Port Inactivity Time setting should be greater than the Force Transmit Interval in Data Packing settings. Otherwise, the connection may be closed before the data in the buffer can be transmitted.</p> <p>To prevent the unintended loss of data due to the session being disconnected, it is highly recommended that this value is set large enough so that the intended data transfer is completed.</p> </div> | 1 to 65535  | 0             |

## Connection Down Settings

| UI Setting            | Description   | Valid Range | Default Value |
|-----------------------|---|-------------|---------------|
| <b>Set RTS Signal</b> | Select the RTS signal method to use.<br><br><b>High:</b> The cellular or Ethernet connection status will not affect RTS signals.<br><br><b>Low:</b> If the cellular or Ethernet connection is lost, RTS signals will change to low. | High / Low  | High          |

| UI Setting            | Description  | Valid Range | Default Value |
|-----------------------|--|-------------|---------------|
| <b>Set DTR Signal</b> | <p>Select the DTR signal method to use.</p> <p><b>High:</b> The cellular or Ethernet connection status will not affect DTR signals.</p> <p><b>Low:</b> If the cellular or Ethernet connection is lost, DTR signals will change to low.</p> | High / Low  | High          |

## Operation Mode - TCP Client

If you select **TCP Client** as your **Operation Mode**, these settings will appear.

Operation Mode \*

TCP Client ▼

---

**Connection Settings**

TCP Alive Check Interval

7

---

1 - 99 min.

Serial Port Inactivity Time

0

---

0 - 65535 ms



Connection Control \*

Startup/None ▼

---

**APPLY**

## Connection Settings

| UI Setting                         | Description  | Valid Range | Default Value |
|------------------------------------|--|-------------|---------------|
| <b>TCP Alive Check Interval</b>    | <p>Specify the interval (in minutes) at which to check if the TCP connection is still alive. If there is no response from the other end of the connection after the specified time, the TCP connection will be terminated. A setting of 0 means the system will keep the TCP connection open and will not send any “keep alive” packets.</p> <div style="background-color: #f0f0f0; padding: 10px; margin-top: 10px;"> <p> <b>Note</b></p> <p>Disabling this option can help free up device resources.</p> </div>   | 1 to 99     | 7             |
| <b>Serial Port Inactivity Time</b> | <p>Specify the time limit in milliseconds to keep the connection open if there is no data going to or from the serial device. If there is no activity for the specified time period, the connection will be terminated. A setting of 0 means the system will always keep the TCP connection open regardless of data activity.</p> <p>For many applications, this option should be set to 0, as the serial device may be idle for long periods of time.</p> <div style="background-color: #f0f0f0; padding: 10px; margin-top: 10px;"> <p> <b>Note</b></p> <p>The serial port inactivity time is only applied when the <b>Connection Control</b> option is set to <b>Any Character/Inactivity Time</b>.</p> </div> <div style="background-color: #fff9c4; padding: 10px; margin-top: 10px;"> <p> <b>Warning</b></p> <p><b>Serial Port Inactivity Time</b> setting should be greater than the <b>Force Transmit Interval</b> in <b>Data Packing</b> settings. Otherwise, the connection may be closed before the data in the buffer can be transmitted.</p> <p>To prevent the unintended loss of data due to the session being disconnected, it is highly recommended that this value is set large enough so that the intended data transfer is completed.</p> </div> | 1 to 65535  | 0             |

| UI Setting                | Description   | Valid Range   | Default Value |
|---------------------------|---|---|---------------|
| <b>Connection Control</b> | <p>Select a connection control method.</p> <p><b>Startup/None:</b> A TCP connection will be established on startup and will remain active indefinitely.</p> <p><b>Any Character/None:</b> A TCP connection will be established when any character is received from the serial interface and will remain active indefinitely.</p> <p><b>Any Character/Inactivity Time:</b> A TCP connection will be established when any character is received from the serial interface and will be disconnected after the specified Serial Port Inactivity Time.</p> <p><b>DSR On/DSR Off:</b> A TCP connection will be established when a DSR "On" signal is received and will be disconnected when a DSR "Off" signal is received.</p> <p><b>DSR On/None:</b> A TCP connection will be established when a DSR "On" signal is received and will remain active indefinitely.</p> <p><b>DCD On/DCD Off:</b> A TCP connection will be established when a DCD "On" signal is received and will be disconnected when a DCD "Off" signal is received.</p> <p><b>DCD On/None:</b> A TCP connection will be established when a DCD "On" signal is received and will remain active indefinitely.</p> | Startup/None / Any Character/None / Any Character/Inactivity Time / DSR On/DSR Off / DSR On/None / DCD On/DCD Off / DCD On/None | Startup/None  |

## TCP Client - Destination Settings

### ⓘ Limitations

You can create up to 4 TCP client destination entries.

### ⚠ Warning

Though up to 4 TCP client destination entries are supported, a low connection speed or throughput on one of the connections will affect the performance of the other active connections.



**Destination Settings**

 🔍 Search

| <input type="checkbox"/>   | IP Address     | Destination Data Port | Local Data Port |
|--|----------------|-----------------------|-----------------|
| <input type="checkbox"/>  | 19.122.111.111 | 4001                  | 60              |

Max. 4

| UI Setting                   | Description                                   |
|------------------------------|---|
| <b>IP Address</b>            | Shows the IP address of the remote host.      |
| <b>Destination Data Port</b> | Shows the TCP port number of the remote host. |
| <b>Local Data Port</b>       | Shows the designated local port.              |

### Add a Destination Entry (TCP Client)

#### Menu Path: Serial - Operation Mode (TCP Client)

Clicking the **Add** () icon on the **Serial - Operation Mode (TCP Client)** page will open this dialog box. This dialog lets you add a destination entry. Click **CREATE** to save your changes and add the new entry.

**Add Destination**

IP Address \*

Destination Data Port \*

Local Data Port \*

CANCEL CREATE

| UI Setting                   | Description  | Valid Range      | Default Value |
|------------------------------|--|------------------|---------------|
| <b>IP Address</b>            | Specify the IP address of the remote host.   | Valid IP address | N/A           |
| <b>Destination Data Port</b> | Specify the TCP port number of the remote host.  | 1 to 65535       | N/A           |
| <b>Local Data Port</b>       | Specify a designated local port or leave this field blank to let the system assign a port. | 1 to 65535       | N/A           |

**Add Destination**

IP Address \*

---

Destination Data Port \* 1 - 65535

---

Local Data Port \* 1 - 65535

---

CANCEL
CREATE

| UI Setting                   | Description  | Valid Range      | Default Value |
|------------------------------|--|------------------|---------------|
| <b>IP Address</b>            | Specify the IP address of the remote host.   | Valid IP address | N/A           |
| <b>Destination Data Port</b> | Specify the TCP port number of the remote host.  | 1 to 65535       | N/A           |
| <b>Local Data Port</b>       | Specify a designated local port or leave this field blank to let the system assign a port. | 1 to 65535       | N/A           |

### Delete a Destination Entry (TCP Client)

#### Menu Path: Serial - Operation Mode (TCP Server)

You can delete a destination entry by using the checkboxes to select the entries you want to delete, then clicking the **Delete** (  ) icon.

**Destination Settings**

 🔍 Search

| <input checked="" type="checkbox"/>   | IP Address     | Destination Data Port | Local Data Port |
|---|----------------|-----------------------|-----------------|
| <input checked="" type="checkbox"/>  | 19.122.111.111 | 4001                  | 60              |

Max: 4

## Operation Mode - UDP

If you select **UDP** as your **Operation Mode**, these settings will appear.

Operation Mode \*  
 UDP ▼

---

**Connection Settings**

UDP Data Port  
 4001

---

1 - 65535

**APPLY**

## Connection Settings

| UI Setting           | Description   | Valid Range | Default Value |
|----------------------|---|-------------|---------------|
| <b>UDP Data Port</b> | Enter the UDP port number for contacting the serial device. | 1 to 65535  | 4001          |

## UDP - Destination Settings

### Limitations

You can create up to 4 UDP destination entries.

Destination Settings



| <input type="checkbox"/> | Start IP Address | End IP Address | Destination Data Port |
|--------------------------|------------------|----------------|-----------------------|
|--------------------------|------------------|----------------|-----------------------|

Max. 4

| UI Setting                   | Description  |
|------------------------------|--|
| <b>Starting IP Address</b>   | Shows the starting IP address of the remote host IP range. |
| <b>End IP Address</b>        | Shows the ending IP address of the remote host IP range.   |
| <b>Destination Data Port</b> | Shows the UDP port number of the remote host.              |

### Add a Destination Entry (UDP)

#### Menu Path: Serial - Operation Mode (UDP)

Clicking the **Add (+)** icon on the **Serial - Operation Mode (UDP)** page will open this dialog box. This dialog lets you add a destination entry. Click **CREATE** to save your changes and add the new entry.

### Note

The maximum IP address range size is 64 addresses. However, when using multicast, you may enter IP addresses in the form xxx.xxx.xxx.255 in the Start IP Address field.

For example, enter 192.168.127.255 to allow the system to broadcast UDP packets to all hosts with IP addresses between 192.168.127.1 and 192.168.127.254.

### Add Destination

Start IP Address \*

---

End IP Address \*

---

Destination Data Port \* ↕

1 - 65535

CANCEL
CREATE

| UI Setting                   | Description  | Valid Range | Default Value |
|------------------------------|--|-------------|---------------|
| <b>Starting IP Address</b>   | Enter the starting IP address of the remote host IP range. | IP Address  | N/A           |
| <b>End IP Address</b>        | Enter the ending IP address of the remote host IP range.   | IP Address  | N/A           |
| <b>Destination Data Port</b> | Enter the UDP port number of the remote host.              | 1 to 65535  | N/A           |

## Delete a Destination Entry (UDP)

### Menu Path: Serial - Operation Mode (UDP)

You can delete a destination entry by using the checkboxes to select the entries you want to delete, then clicking the **Delete (🗑)** icon.

#### Destination Settings

🗑
🔍 Search

|                                     | IP Address  | Destination Data Port | Local Data Port |
|-------------------------------------|---|-----------------------|-----------------|
| <input checked="" type="checkbox"/> | <span style="font-size: small;">✎</span> 19.122.111.111 | 4001                  | 60              |

Max. 4

# Data Packing

## Menu Path: Serial - Data Packing

This page lets you configure the conditions and delimiter settings for serial port data buffering and transmission.

Packet Length  
  
 0 - 1024 bytes

Force Transmit Interval  
  
 0 - 65535 ms

### Delimiter Settings

Delimiter 1 Enable \*  
 ▼

Delimiter 1 \*  
  
 Hex digit

Delimiter 2 Enable \*  
 ▼

Delimiter 2 \*  
  
 Hex digit

Delimiter Process \*  
 ▼

**APPLY**

| UI Setting           | Description   | Valid Range | Default Value |
|----------------------|---|-------------|---------------|
| <b>Packet Length</b> | <p>Specify the Packet Length in bytes for the serial port buffer. The packet length refers to the maximum amount of data that is allowed to accumulate in the serial port buffer before sending.</p> <p>At the default packet length of 0, no maximum amount is specified and data in the buffer will be sent as specified by the delimiter settings or when the buffer is full.</p> <p>If a packet length of 1 to 1024 bytes is specified, data in the buffer will be sent as soon as it reaches the specified length.</p> | 0 to 1024   | 0             |

| UI Setting                     | Description   | Valid Range | Default Value |
|--------------------------------|---|-------------|---------------|
| <b>Force Transmit Interval</b> | <p>Specify the interval in milliseconds to force transmission of serial port data if no activity is recorded.</p> <p>This setting controls data packing by the amount of time that elapses between bits of data. As serial data is received, it accumulates in the device port's buffer. If serial data is not received for the specified amount of time, the data that is currently in the buffer is packed for network transmission.</p> <p>A setting of 0 means that data in the buffer will not be automatically packed when additional data is not received from the device.</p> | 0 to 65535  | 0             |

## Delimiter Settings

| UI Setting                  | Description  | Valid Range        | Default Value |
|-----------------------------|--|--------------------|---------------|
| <b>Delimiter 1/2 Enable</b> | <p>Enable or disable delimiter 1 or 2.</p> <p><b>Enabled:</b> The serial port will queue data in the buffer and send it to the cellular or Ethernet port when a specific hex character is received. When both Delimiter 1 and 2 are enabled and specified, both of them will be used to control when data should be sent.</p> <p><b>Disabled:</b> The serial port will not check for specific characters for data transmission.</p> <div style="background-color: #fff9c4; padding: 10px; margin-top: 10px;"> <p><b>⚠ Warning</b></p> <p>When <b>Delimiter</b> is enabled, the <b>Packet Length</b> must be set to 0.</p> </div> | Disabled / Enabled | Disabled      |
| <b>Delimiter 1/2</b>        | <p>Specify the character that acts as the delimiter to control when data should be sent.</p> <div style="background-color: #fff9c4; padding: 10px; margin-top: 10px;"> <p><b>⚠ Warning</b></p> <p>When the device port buffer is full, the data will be packed for network transmission regardless of the <b>Delimiter 1</b>, <b>Delimiter 2</b>, and <b>Force Transmit Interval</b> settings.</p> </div>  | 0x00 to 0xFF       | 0x00          |

| UI Setting               | Description   | Valid Range  | Default Value |
|--------------------------|---|--|---------------|
| <b>Delimiter Process</b> | <p>Select the delimiter process.</p> <p><b>Delimiter:</b> Data in the buffer will be transmitted when the delimiter is received.</p> <p><b>Delimiter +1:</b> Data in the buffer will be transmitted after 1 additional byte is received following the delimiter.</p> <p><b>Delimiter +2:</b> Data in the buffer will be transmitted after 2 additional bytes are received following the delimiter.</p> <p><b>Strip Delimiter:</b> Data in the buffer is stripped of the delimiter before being transmitted.</p> | Delimiter /<br>Delimiter +1 /<br>Delimiter +2 /<br>Strip Delimiter | Delimiter     |

## Serial - Status

### Menu Path: Serial - Status

This page lets you see detailed statistics and information about the serial port data and connections.

### Error Counter

| Error Counter     |                    |               |             |
|-------------------|--------------------|---------------|-------------|
| Frame Error Count | Parity Error Count | Overrun Count | Break Count |
| 0                 | 0                  | 0             | 0           |

| UI Setting                | Description   |
|---------------------------|---|
| <b>Frame Error Count</b>  | Shows the number of frame errors since the device was powered on.   |
| <b>Parity Error Count</b> | Shows the number of parity errors since the device was powered on.  |
| <b>Overrun Count</b>      | Shows the number of overrun errors since the device was powered on. |
| <b>Break Count</b>        | Shows the number of break errors since the device was powered on.   |



# Serial Counter

**Serial Counter**

|          |                |          |                |
|----------|----------------|----------|----------------|
| TX Count | TX Total Count | RX Count | RX Total Count |
| 0        | 0              | 0        | 0              |

| UI Setting            | Description  |
|-----------------------|--|
| <b>TX Count</b>       | Shows the number of packets transmitted.   |
| <b>TX Total Count</b> | Shows the total total number of packets transmitted since the device was powered on. |
| <b>RX Count</b>       | Shows the number of packets received.  |
| <b>RX Total Count</b> | Shows the total total number of packets received since the device was powered on.    |

# Serial State

**Serial State**

- DSR
- DTR
- RTS
- CTS
- DCD

| UI Setting          | Description  |
|---------------------|--|
| <b>Serial State</b> | Shows the status of the serial signal.<br><b>Green:</b> The signal pins are connected.<br><b>Grey:</b> The signal pins are disconnected. |

## Serial - Connection List

| Connection List |            |
|-----------------|------------|
| Search          |            |
| Operation Mode  | IP Address |

| UI Setting            | Description                                  |
|-----------------------|--|
| <b>Operation Mode</b> | Shows the operation mode for the connection. |
| <b>IP Address</b>     | Shows the IP address of the connection.      |

## Serial Data Logs

### Menu Path: Serial - Serial Data Logs

This page lets you see the device's serial data logs in ASCII or HEX format.

- Click the **Refresh icon** (🔄) icon to refresh the serial data logs.
- Click the **Clear Data Log icon** (🗑️) icon to delete all serial data logs.
- Click the **Export icon** (📄) icon to export all serial data logs to a file.
- Click **ASCII** or **HEX** to change the format of the logs.

|                        |                  | ASCII      | HEX     |
|------------------------|------------------|------------|---------|
| 2024/12/27 03:31:34[T] | 27/12/2411:34:29 | 0200:11:04 | 7631663 |
| 2024/12/27 03:31:37[T] | 27/12/2411:34:23 | 0200:05:41 | 3548649 |
| 2024/12/27 03:31:40[T] | 27/12/2411:34:26 | 0200:03:49 | 4965170 |
| 2024/12/27 03:31:43[T] | 27/12/2411:34:29 | 0200:06:24 | 1578927 |
| 2024/12/27 03:31:46[T] | 27/12/2411:34:32 | 0200:06:14 | 3935351 |
| 2024/12/27 03:31:49[T] | 27/12/2411:34:35 | 0200:04:48 | 3617708 |
| 2024/12/27 03:31:52[T] | 27/12/2411:34:38 | 0200:12:18 | 1434903 |

# Network Configuration

## Menu Path: Network Configuration

The Network Configuration settings area lets you configure settings related to your device's networking ports.

This settings area includes these sections:

- Ports
- Layer 2 Switching
- Network Interfaces

## Network Configuration - User Privileges

Privileges to Network Configuration settings are granted to the different authority levels as follows. Refer to [System > Account Management > User Accounts](#) for more information on user accounts.

| Settings                      | Admin | Supervisor | User |
|-------------------------------|-------|------------|------|
| <b>Ports</b>                  |       |            |      |
| <b>Port Settings</b>          | R/W   | R/W        | R    |
| <b>Link Aggregation</b>       | R/W   | R/W        | R    |
| <b>PoE</b>                    | R/W   | R/W        | R    |
| <b>Link Fault Passthrough</b> | R/W   | R/W        | R    |
| <b>LAN Bypass Gen3</b>        | R/W   | R/W        | R    |
| <b>Layer 2 Switching</b>      |       |            |      |
| <b>VLAN</b>                   | R/W   | R/W        | R    |
| <b>MAC Address Table</b>      | R/W   | R/W        | R    |
| <b>QoS</b>                    | R/W   | R/W        | R    |
| <b>Rate Limit</b>             | R/W   | R/W        | R    |

| Settings                  | Admin | Supervisor | User |
|---------------------------|-------|------------|------|
| <b>Multicast</b>          | R/W   | R/W        | R    |
| <b>Network Interfaces</b> | R/W   | R/W        | R    |

## Ports

### Menu Path: [Network Configuration](#) > [Ports](#)

This section includes these pages:

- [Port Settings](#)
- [Link Aggregation](#)
- [PoE](#)
- [Link Fault Passthrough](#)
- [LAN Bypass Gen3](#)

## Port Settings

### Menu Path: [Network Configuration](#) > [Ports](#) > [Port Settings](#)









This page includes these tabs:

- [Settings](#)
- [Status](#)

## Port Settings - Settings

### Menu Path: [Network Configuration](#) > [Ports](#) > [Port Settings - Settings](#)

This tab lets you view and adjust the settings for each port.

| Port Settings  |         |                 |             |              |              |          |  |
|--|---------|-----------------|-------------|--------------|--------------|----------|--|
| Setting  |         |                 |             | Status       |              |          |  |
| Q Search   |         |                 |             |              |              |          |  |
| Port   | Status  | Media Type      | Description | Speed/Duplex | Flow Control | MDI/MDIX |  |
|  3    | Enabled | 1000TX,RJ45     |             | Auto         | Disabled     | Auto     |  |
|  4    | Enabled | 1000TX,RJ45     |             | Auto         | Disabled     | Auto     |  |
|  5    | Enabled | 1000TX,RJ45     |             | Auto         | Disabled     | Auto     |  |
|  6    | Enabled | 1000TX,RJ45     |             | Auto         | Disabled     | Auto     |  |
|  8    | Enabled | 1000TX,RJ45     |             | Auto         | Disabled     | Auto     |  |
|  G1   | Enabled | 1000FX,miniGBIC |             | ---          | Disabled     | ---      |  |
|  G2   | Enabled | 1000FX,miniGBIC |             | ---          | Disabled     | ---      |  |
|  Trk1 | Enabled | ---             |             | ---          | ---          | ---      |  |
|  Trk2 | Enabled | ---             |             | ---          | ---          | ---      |  |

1 - 9 of 9

| UI Setting            | Description   |
|-----------------------|---|
| <b>Port</b>           | Shows which port this row describes.                                |
| <b>Status</b>         | Shows the status of the port.                                       |
| <b>Media Type</b>     | Shows the port's media type.  |
| <b>Description</b>    | Shows the description for the port.                                 |
| <b>Speed / Duplex</b> | Shows the speed and duplex mode for the port.                       |
| <b>Flow Control</b>   | Shows the whether flow control is enabled or disabled for the port. |
| <b>MDI / MDIX</b>     | Shows the MDI/MDIX setting for the port.                            |

## Edit Port Settings

### Menu Path: Network Configuration > Ports > Port Settings - Settings

Clicking the **Edit** () icon for a port on the **Network Configuration > Ports > Port Settings - Settings** page will open this dialog box. This dialog lets you change the settings for a port. Click **APPLY** to save your changes.

### Edit Port 3 Settings

Status \*  
Enabled ▾

Media Type  
1000TX,RJ45

Description  
0 / 127



Speed/Duplex Mode \*  
Auto ▾

Flow Control \*  
Disabled ▾ ⓘ

MDI/MDIX \*  
Auto ▾

CANCEL
APPLY

| UI Setting            | Description   | Valid Range  | Default Value     |
|-----------------------|---|--|-------------------|
| <b>Status</b>         | Enable or disable the port.   | Enabled / Disabled                                 | Enabled           |
| <b>Media Type</b>     | Displays the port's media type. This setting cannot be changed.   | N/A  | Port's media type |
| <b>Description</b>    | Enter a description for the port to make it easier to identify.   | 1 to 127 characters                                | N/A               |
| <b>Speed / Duplex</b> | <p>Select the speed and duplex mode for the port.</p> <p><b>Auto:</b> Allows the port to use IEEE 802.3u protocol to negotiate the best port speed and duplex mode to use for the connected device.</p> <p><b>100M-Full:</b> This will force the port to connect using 100 Mbps at full-duplex.</p> <p><b>100M-Half:</b> This will force the port to connect using 100 Mbps at half-duplex.</p> <p><b>10M-Full:</b> This will force the port to connect using 10 Mbps at full-duplex.</p> <p><b>10M-Half:</b> This will force the port to connect using 10 Mbps at half-duplex.</p> | Auto / 100M-Full / 100M-Half / 10M-Full / 10M-Half | Auto              |

| UI Setting          | Description  | Valid Range        | Default Value |
|---------------------|--|--------------------|---------------|
| <b>Flow Control</b> | <p>Enable or disable flow control for this port when the port's <b>Speed/Duplex</b> setting is set to <b>Auto</b>. Flow control helps manage the data transfer rate between the device and the connected Ethernet devices.</p> <div style="background-color: #f0f0f0; padding: 5px; margin-top: 10px;"> <p> <b>Note</b></p> <p>Flow Control can be enabled or disabled but is only effective in full-duplex. Back Pressure is enabled by default but works only in half-duplex. When using the SFP ports for WAN1 or WAN2 on the EDR-G9004, Flow Control will be ineffective.</p> </div> <div style="background-color: #f0f0f0; padding: 5px; margin-top: 10px;"> <p> <b>Note</b></p> <p>If <b>Speed/Duplex</b> is set to something other than <b>Auto</b>, <b>Flow Control</b> will be disabled.</p> </div> | Enabled / Disabled | Disabled      |
| <b>MDI / MDIX</b>   | <p>Select whether the port should use MDI or MDIX. The correct setting depends on both the connected device and the cabling used to connect to the device.</p> <ul style="list-style-type: none"> <li>• <b>Auto</b>: Allow the port to auto-detect whether to use MDI or MDIX for connected devices.</li> <li>• <b>MDI</b>: Force the port to use MDI (also known as "straight-through").</li> <li>• <b>MDIX</b>: Force the port to use MDIX (also known as "crossover").</li> </ul> <div style="background-color: #f0f0f0; padding: 5px; margin-top: 10px;"> <p> <b>Note</b></p> <p>Only choose MDI or MDIX if your connected Ethernet device has trouble auto-negotiating the correct port type.</p> </div>   | Auto / MDI / MDIX  | Auto          |

## Port Settings - Status

**Menu Path:** [Network Configuration](#) > [Ports](#) > [Port Settings - Status](#)

This tab lets you monitor the status of each port. Click the **Refresh** (  ) button to refresh the table.

| Port Settings   |         |             |             |             |              |          |            |
|---|---------|-------------|-------------|-------------|--------------|----------|------------|
| Setting   |         | Status      |             |             |              |          |            |
| <div style="display: flex; justify-content: space-between; align-items: center;"> <span>↻</span> <span>🔍 Search</span> </div> |         |             |             |             |              |          |            |
| Port  | Status  | Media Type  | Link Status | Description | Flow Control | MDI/MDIX | Port State |
| 3   | Enabled | 1000TX,RJ45 | 100M-Full   |             | Off          | MDI      | Forwarding |
| 4   | Enabled | 1000TX,RJ45 | --          |             | --           | --       | --         |
| 5   | Enabled | 1000TX,RJ45 | --          |             | --           | --       | --         |
| 6   | Enabled | 1000TX,RJ45 | 100M-Full   |             | Off          | MDI      | Forwarding |
| 8   | Enabled | 1000TX,RJ45 | 1G-Full     |             | Off          | MDI      | Forwarding |
| G1  | Enabled | N/A         | --          |             | --           | --       | --         |
| G2  | Enabled | N/A         | --          |             | --           | --       | --         |
| Trk1  | Enabled | --          | --          | --          | --           | --       | --         |
| Trk2  | Enabled | --          | 1G-Full     | --          | --           | --       | --         |
| 1 - 9 of 9  |         |             |             |             |              |          |            |

| UI Setting          | Description  |
|---------------------|--|
| <b>Port</b>         | Shows which port this row describes.   |
| <b>Status</b>       | Shows the status of the port.  |
| <b>Media Type</b>   | Shows the port's media type.   |
| <b>Link Status</b>  | Shows the speed and duplex mode the connection is currently using.<br>If the link is not active, a - will be shown.  |
| <b>Description</b>  | Shows the description for the port.  |
| <b>Flow Control</b> | Shows the whether flow control is currently on or off for the port.<br>If the link is not active, a - will be shown. |
| <b>MDI / MDIX</b>   | Shows whether the port is using MDI or MDIX for its connection.<br>If the link is not active, a - will be shown.     |
| <b>Port State</b>   | Shows the port state for the port.<br>If the link is not active, a - will be shown.                                  |



# Link Aggregation

## Menu Path: Network Configuration > Ports > Link Aggregation

This page lets you configure link aggregation for your device. Link aggregation (or port trunking) is the process of combining multiple physical network links into a single logical link to increase bandwidth, improve redundancy and availability, and provide load balancing across links.

**Note**

Ports in the same link aggregation must have the same speed.

**Note**

If a port is being used for Turbo Ring or Turbo Chain, it will not appear in the Link Aggregation list.

**Note**

For TN-4916 models with only 4 Gigabit ports, ports 1 to 8 cannot be aggregated with ports 9-12 due to design limitations.

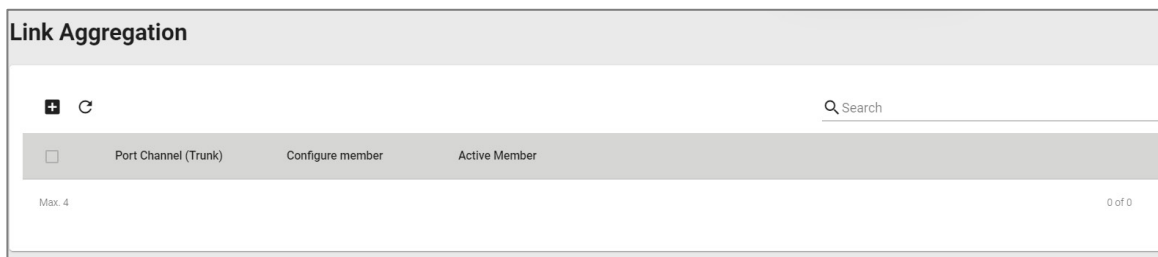

## Create Link Aggregation

### Menu Path: Network Configuration > Ports > Link Aggregation

Clicking the **Add (+)** icon on the **Network Configuration > Ports > Link Aggregation** page will open this dialog box. This dialog lets you create a new link aggregation with member ports.

**Create Link Aggregation**

If you want to activate new port trunking settings, the all functions related to the trunking ports will be set to default values.

Config Member Port \* 

CANCEL CREATE

| UI Setting                | Description   | Valid Range         | Default Value |
|---------------------------|---|---------------------|---------------|
| <b>Config Member Port</b> | Select the ports you want to include in the link aggregation group. | Port drop-down menu | N/A           |

## Edit Link Aggregation

**Menu Path: Network Configuration > Ports > Link Aggregation**

Clicking the **Edit** (✎) icon for a link aggregation on the **Network Configuration > Ports > Link Aggregation** page will open this dialog box. This dialog lets you edit an existing link aggregation with member ports.

**Edit Port Channel 1 Settings**

If you want to activate new port trunking settings, the all functions related to the trunking ports will be set to default values.

Config Member Port \* 

1

CANCEL APPLY

| UI Setting                | Description   | Valid Range         | Default Value |
|---------------------------|---|---------------------|---------------|
| <b>Config Member Port</b> | Select the ports you want to include in the link aggregation group. | Port drop-down menu | N/A           |

## Delete Link Aggregation

**Menu Path: Network Configuration > Ports > Link Aggregation**

You can delete link aggregations by using the checkboxes to select the link aggregations you want to delete, then clicking the **Delete** (🗑) icon.

| Link Aggregation                    |                      |                  |               |
|-------------------------------------|----------------------|------------------|---------------|
|                                     | Port Channel (Trunk) | Configure member | Active Member |
| <input checked="" type="checkbox"/> | 1                    | 1                |               |
| <input type="checkbox"/>            | 2                    | 2,7              | 7             |

Max. 4 1 - 2 of 2

## PoE

### Menu Path: Network Configuration > Ports > PoE

This section lets you configure your device's Power over Ethernet (PoE) settings. PoE allows your Moxa device to power other connected PoE Ethernet devices—such as security cameras, wireless access points, and sensors—through the Ethernet cable.

#### Note

PoE functionality is only available on specific PoE-enabled Moxa device models. Connected PoE devices must support the IEEE 802.3af/at standard in order to use this feature.

This page includes these tabs:

- General
- PD Failure Check
- Scheduling
- Status

## PoE - General

### Menu Path: Network Configuration > Ports > PoE - General

This page lets you enable or disable various PoE related features. Click **APPLY** to save your changes.

## PoE Settings

Power Output \*

Power Management Mode \*  
 ⓘ







Auto Power Cutting \*  
 ⓘ

System Power Budget \*  
 ⓘ  
30 - 95 Watt

**APPLY**

| UI Setting                   | Description   | Valid Range                      | Default Value   |
|------------------------------|---|----------------------------------|---|
| <b>Power Output</b>          | Enable or disable PoE for the device.   | Enabled / Disabled               | Enabled   |
| <b>Power Management Mode</b> | <p>Specify how the power budget for all ports should be calculated.</p> <ul style="list-style-type: none"> <li>• <b>Allocated Power:</b> This calculates the power budget based on the power allocation settings of all ports. For more information on per-port power allocation, refer to <a href="#">PoE - General - Edit Port Settings</a>.</li> <li>• <b>Consumed Power:</b> This calculates the power budget based on actual power consumed by all ports.</li> </ul> | Allocated Power / Consumed Power | Consumed Power  |
| <b>Auto Power Cutting</b>    | Enable or disable Auto Power Cutting, which allows PoE to be disabled for ports when total power consumption exceeds the system power budget threshold. Ports with lower priority will be disabled before ports with higher priority.   | Enabled / Disabled               | Disabled  |
| <b>System Power Budget</b>   | Specify the "total measured power" budget in watts to use for all PoE ports combined. This is used as a threshold for the Auto Power Cutting feature.   | (Depends on your device model)   | <p>(Depends on your device model)</p> <p>TN-4916 PoE models: 95 W</p> <p>TN-4908 PoE models: 50 W</p> |

## PoE Port List

|  <span style="float: right;">Q Search</span> |      |               |              |             |                  |                     |          |
|---|------|---------------|--------------|-------------|------------------|---------------------|----------|
|   | Port | PoE Supported | Power Output | Output Mode | Power Allocation | Legacy PD Detection | Priority |
|    | 1    | Yes           | Enabled      | Auto        | 0                | Disabled            | Low      |
|    | 2    | Yes           | Enabled      | Auto        | 0                | Disabled            | Low      |
|    | 3    | Yes           | Enabled      | Auto        | 0                | Disabled            | Low      |
|    | 4    | Yes           | Enabled      | Auto        | 0                | Disabled            | Low      |
|    | 5    | Yes           | Enabled      | Auto        | 0                | Disabled            | Low      |

| UI Setting                 | Description  |
|----------------------------|--|
| <b>Port</b>                | Shows which port the entry is for.   |
| <b>PoE Supported</b>       | Shows whether PoE is supported for the port.   |
| <b>Power Output</b>        | Shows whether PoE is enabled for the port.   |
| <b>Output Mode</b>         | Shows the PoE output mode for the port.  |
| <b>Power Allocation</b>    | Shows how much power in watts is allocated to the port. <div style="background-color: #f0f0f0; padding: 10px; margin-top: 10px;"> <p> <b>Note</b></p> <p>If the <b>Output Mode</b> for the port is set to <b>Auto</b>, the port's power allocation will be displayed as 0.</p> </div> |
| <b>Legacy PD Detection</b> | Shows whether legacy PD detection is enabled for the port.   |
| <b>Priority</b>            | Shows the priority of the port for use with the Auto Power Cutting feature. PoE will be disabled for ports with lower priority first when total power consumption exceeds the system power budget threshold.   |

## PoE - General - Edit Port Settings

### Menu Path: Network Configuration > Ports > PoE - General

Clicking the **Edit** (✎) icon for a port on the **Network Configuration > Ports > PoE - General** page will open this dialog box. This dialog lets you configure the PoE settings for a specific port. Click **APPLY** to save your changes.

### Edit Port 1 Settings

Power Output \*

Output Mode \*      Legacy PD Detection \*  
     

Power Allocation  
  
 0 - 36      Watt

Priority \*

Copy Configurations to Ports  ⓘ





| UI Setting          | Description   | Valid Range               | Default Value |
|---------------------|---|---------------------------|---------------|
| <b>Power Output</b> | Enable or disable PoE for the port.   | Enabled / Disabled        | Enabled       |
| <b>Output Mode</b>  | Specify whether to set the PoE output mode to Auto or Force.<br><b>Auto:</b> Power output will be determined by using 802.3at auto-detection.<br><b>High Power:</b> 36 watts will be allocated to the PD connected to the port if it requires more than 30 watts of power.<br><b>Force:</b> Power output will be determined by the <b>Power Allocation</b> setting for the port. This may be necessary for PDs that do not follow 802.3af/at standards. | Auto / High Power / Force | Auto          |

| UI Setting                  | Description   | Valid Range                            | Default Value |
|-----------------------------|---|--|---------------|
| <b>Legacy PD Detection</b>  | <p>Enable or disable Legacy PD Detection. Legacy PD Detection will trigger the system to output power to the connected PD when the capacitance of the PD is higher than 2.7 <math>\mu\text{F}</math> and less than 10 <math>\mu\text{F}</math>.</p> <p>It will take a few seconds for PoE power to be output through the port (if triggered) after enabling Legacy PD Detection.</p>  | Enabled / Disabled                     | Disabled      |
| <b>Power Allocation</b>     | <p>Specify the power in watts to allocate to a connected PD when the <b>Output Mode</b> is set to <b>Force</b>.</p> <div style="background-color: #f0f0f0; padding: 10px; margin-top: 10px;"> <p> <b>Note</b></p> <p>This setting cannot be adjusted if the <b>Output Mode</b> is set to <b>Auto</b> or <b>High Power</b>.</p> <p>It will be fixed as <b>0</b> in <b>Auto mode</b>, and as <b>36</b> in <b>High Power mode</b>.</p> </div> | 0 to 36 W                              | 0             |
| <b>Priority</b>             | <p>Specify the priority of the port to use with the <b>Auto Power Cutting</b> feature. If Auto Power Cutting is enabled, PoE will be disabled for ports when total power consumption exceeds the system power budget threshold. Ports with lower priority will be disabled before ports with higher priority.</p> <p>Refer to <a href="#">PoE Settings</a> for more information.</p>  | Critical / High / Low                  | Low           |
| <b>Copy Config to Ports</b> | Specify which ports you want to copy this configuration to.   | Select port(s) from the drop-down list | None          |

## PoE PD Failure Check

### Menu Path: Network Configuration > Ports > PoE - PD Failure Check

This tab lets you monitor the status of a powered device (PD) through its IP address. If the PD fails, the switch will not receive a PD response after the defined period, and the authentication process will be restarted. This function is extremely useful for ensuring network reliability and simplifying management.

|   |      | Q Search      |          |           |                        |                   |           |
|---|------|---------------|----------|-----------|------------------------|-------------------|-----------|
|   | Port | PoE Supported | Status   | Device IP | Check Frequency (sec.) | No Response Times | Action    |
|  | 1    | Yes           | Disabled |           | 10                     | 3                 | No Action |
|  | 2    | Yes           | Disabled |           | 10                     | 3                 | No Action |
|  | 3    | Yes           | Disabled |           | 10                     | 3                 | No Action |
|  | 4    | Yes           | Disabled |           | 10                     | 3                 | No Action |
|  | 5    | Yes           | Disabled |           | 10                     | 3                 | No Action |

| UI Setting                    | Description   |
|-------------------------------|---|
| <b>Port</b>                   | Shows which port the entry is for.  |
| <b>PoE Supported</b>          | Shows whether the port supports PoE.  |
| <b>Status</b>                 | Shows whether PD failure checking is enabled or disabled for the port.                            |
| <b>Device IP</b>              | Shows the IP that will be monitored for PD failure checks for the port.                           |
| <b>Check Frequency (sec.)</b> | Shows the frequency in seconds to perform PD failure checks for the port.                         |
| <b>No Response Times</b>      | Shows how many consecutive PD failure checks must fail before determining a PD is not responding. |
| <b>Action</b>                 | Shows what action will be taken if a PD failure is detected for the port.                         |

## PoE - PD Failure Check - Edit Port Settings

### Menu Path: Network Configuration > Ports > PoE - PD Failure Check

Clicking the **Edit (  )** icon for a port on the **Network Configuration > Ports > PoE - PD Failure Check** page will open this dialog box. This dialog lets you configure the PD failure check settings for each port. Click **APPLY** to save your changes.



### Edit Port 1 Settings

Status \*  
Disabled ▼

Device IP

Check Frequency \*                      No Response Times \*  
10                      3

5 - 300                      sec.                      1 - 10                      times

Action \*  
No Action ▼

Copy Configurations to Ports                      ▼                      i

CANCEL
APPLY

| UI Setting                          | Description  | Valid Range                            | Default Value |
|-------------------------------------|--|--|---------------|
| <b>Status</b>                       | Enable or disable the PD failure check function.   | Enabled / Disabled                     | Disabled      |
| <b>Device IP</b>                    | Specify the PD's IP address.   | IP address                             | None          |
| <b>Check Frequency</b>              | Specify how often PD failure checks will run.  | 5 to 300 seconds                       | 10            |
| <b>No Response Times</b>            | Specify the maximum number of IP checking cycles to try before determining a PD is not responding. | 1 to 10                                | 3             |
| <b>Action</b>                       | Decide what action to take when a PD failure is detected.  | No Action / Restart PD / Shutdown PD   | No Action     |
| <b>Copy configurations to ports</b> | Select the ports you want to copy this configuration to.   | Select port(s) from the drop-down list | None          |

### Edit Port 1 Settings

Status \*  
Disabled ▼

Device IP

Check Frequency \*      No Response Times \*  
10      3

5 - 300      sec.      1 - 10      times

Action \*  
No Action ▼

Copy Configurations to Ports      ▼      i

CANCEL
APPLY

| UI Setting               | Description  | Valid Range                           | Default Value |
|--------------------------|--|---------------------------------------|---------------|
| <b>Status</b>            | Enable or disable PD failure checking for the port.  | Enabled / Disabled                    | Disabled      |
| <b>Device IP</b>         | Specify the IP that will be monitored for PD failure checks for the port. This is normally set to the connected PD's IP. PD failure checks will ping this IP, and will result in a "fail" if there is no response from the IP.   | IP address                            | None          |
| <b>Check Frequency</b>   | Specify the frequency in seconds to perform PD failure checks for the port.  | 5 to 300                              | 10            |
| <b>No Response Times</b> | Specify how many consecutive PD failure checks must fail before determining a PD is not responding and executing the specified action for the rule.  | 1 to 10                               | 3             |
| <b>Action</b>            | Decide what action to take when a PD failure is determined.<br><br><b>No Action:</b> The PD failure will be logged, but no action will be taken.<br><br><b>Restart PD:</b> PoE power for the port will be stopped, and then start again to restart the connected PD.<br><br><b>Shut down PD:</b> PoE power for the port will be stopped. | No Action / Restart PD / Shut down PD | No Action     |

| UI Setting                          | Description  | Valid Range                            | Default Value |
|-------------------------------------|--|--|---------------|
| <b>Copy configurations to ports</b> | Select the ports you want to copy this configuration to. | Select port(s) from the drop-down list | None          |

## PoE - Scheduling

### Menu Path: Network Configuration > Ports > PoE - Scheduling

This tab lets you set schedules for each PoE port. Switch to Advanced Mode, click the Scheduling tab, and then click the + icon to create the scheduling settings.

#### 🔑 Limitations

You can create up to 20 PoE scheduling rules.

## System Time Status

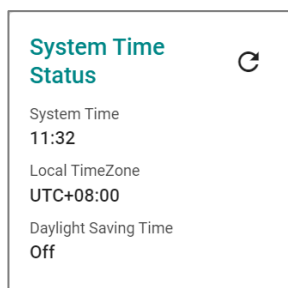

| UI Setting                  | Description  |
|-----------------------------|--|
| <b>System Time</b>          | Shows the device's current system time.  |
| <b>Local TimeZone</b>       | Shows the device's local time zone.  |
| <b>Daylight Saving Time</b> | Shows whether a daylight saving time adjustment is currently applied to the system time. |

## PoE Scheduling Rule List

|         | Rule Name | Status | Start Date | Schedule Time | Apply the rule to the port |
|---------|-----------|--------|------------|---------------|----------------------------|
| Max. 20 |           |        |            |               | 0 of 0                     |

| UI Setting                        | Description  |
|-----------------------------------|--|
| <b>Rule Name</b>                  | Shows the name for the scheduling rule the entry is for. |
| <b>Status</b>                     | Shows whether the rule is enabled or disabled.           |
| <b>Start Date</b>                 | Shows what date the rule will start on.                  |
| <b>Schedule Time</b>              | Shows when PoE will be enabled for ports using the rule. |
| <b>Apply the rule to the port</b> | Shows which ports will use this rule.                    |

### PoE - Scheduling - Create Rule

#### Menu Path: Network Configuration > Ports > PoE - Scheduling

Clicking the **Add (+)** icon on the **Network Configuration > Ports > PoE - Scheduling** page will open this dialog box. This dialog lets you create a PoE scheduling rule. Click **CREATE** to save your changes and add the new rule.

### PoE - Scheduling - Edit Rule

#### Menu Path: Network Configuration > Ports > PoE - Scheduling

Clicking the **Edit (✎)** icon on the **Network Configuration > Ports > PoE - Scheduling** page will open this dialog box. This dialog lets you edit an existing PoE scheduling rule.

Click **APPLY** to save your changes.

### Edit Rule

Rule Name \*  
OfficeHours  
11 / 63

Rule \*  
Enabled ▼

Start Date \*  
2024-12-01

Start Time \*  
08:00 AM

End Time \*  
06:00 PM

Repeat Execution \*  
Daily ▼

Apply the rule to the port \*  
4 ▼

CANCEL
APPLY

| UI Setting                    | Description   | Valid Range                            | Default Value |
|-------------------------------|---|--|---------------|
| <b>Rule Name</b>              | Specify a name for the scheduling rule.   | 1 to 63 characters                     | N/A           |
| <b>Enable</b>                 | Enable or disable the scheduling rule.  | Enabled / Disabled                     | Enabled       |
| <b>Start Date</b>             | Specify a start date for the rule. You can click the calendar icon to open a date picker to select a date.  | yyyy-mm-dd                             | N/A           |
| <b>Start Time</b>             | Specify a start time for the rule. PoE power to the specified ports will be supplied after the start time. You can click the clock icon to open a time picker to select a time. | hh:mm AM/PM                            | N/A           |
| <b>End Time</b>               | Specify an end time for the rule. PoE power to the specified ports will be stopped after the end time. You can click the clock icon to open a time picker to select a time.     | hh/mm AM/PM                            | N/A           |
| <b>Repeat Execution</b>       | Specify whether to repeat execution of the rule on a daily or weekly basis.   | None / Daily / Weekly                  | N/A           |
| <b>Apply the rule to port</b> | Specify which ports should use this rule.   | Select port(s) from the drop-down list | N/A           |

## PoE - Scheduling - Delete Rule

You can delete a rule by using the checkboxes to select the entries you want to delete, then clicking the **Delete** (  ) icon.

## PoE - Status

**Menu Path: Network Configuration > Ports > PoE - Status**

This tab lets you view the current PoE status of your ports.

## PoE - System Status

### System Status

Maximum Input Power  
**95 Watts**

Allocated Power  
0 Watts

Consumed Power  
0 Watts

Remaining Power Available   
**95 Watts**

| UI Setting                       | Description   |
|----------------------------------|---|
| <b>Maximum Input Power</b>       | Shows the maximum power budget of the device.       |
| <b>Allocated Power</b>           | Shows the total allocated PoE power.                |
| <b>Consumed Power</b>            | Shows the total consumed PoE power.                 |
| <b>Remaining Power Available</b> | Shows the remaining power available for the device. |

 **Note**

Remaining Power Available is calculated as Maximum Input Power minus Allocated Power.

## PoE Port Status List

| Port | PoE Supported | Power Output | Classification | Current (mA) | Voltage (V) | Consumption (W) | Device Type | Configuration suggestion | PD Failure Check Status |
|------|---------------|--------------|----------------|--------------|-------------|-----------------|-------------|--------------------------|-------------------------|
| 1    | Yes           | Off          | Unknown        | 0            | 0           | 0               | Unknown     | Disable PoE power output | Disabled                |
| 2    | Yes           | Off          | Unknown        | 0            | 0           | 0               | Unknown     | Disable PoE power output | Disabled                |
| 3    | Yes           | Off          | Unknown        | 0            | 0           | 0               | Unknown     | Disable PoE power output | Disabled                |
| 4    | Yes           | Off          | Unknown        | 0            | 0           | 0               | Not present | No suggestion            | Disabled                |
| 5    | Yes           | Off          | Unknown        | 0            | 0           | 0               | Unknown     | Disable PoE power output | Disabled                |

| UI Setting             | Description   |
|------------------------|---|
| <b>Port</b>            | Shows the number of the PoE port the entry is for.  |
| <b>PoE Supported</b>   | Shows whether the port supports PoE.  |
| <b>Power Output</b>    | Shows whether PoE power output is on or off for the port.   |
| <b>Classification</b>  | Shows the PoE power classification of the port.<br>Each PoE power classification has a different maximum power (in watts) by PSE output as follows:<br><b>0:</b> 15.4 watts<br><b>1:</b> 4 watts<br><b>2:</b> 7 watts<br><b>3:</b> 15.4 watts<br><b>4:</b> 30 watts   |
| <b>Current (mA)</b>    | Shows the amount of current in mA being supplied to the port.   |
| <b>Voltage (V)</b>     | Shows the voltage in V being used for the port.   |
| <b>Consumption (W)</b> | Shows the power consumption in W of the device connected to the port.   |
| <b>Device Type</b>     | Shows the device type of the device currently connected to the port.<br><b>Not Present:</b> There are no active connections to the port.<br><b>802.3at:</b> An IEEE 802.3at PD is connected to the port.<br><b>802.3af:</b> An IEEE 802.3af PD is connected to the port.<br><b>NIC:</b> A NIC is connected to the port.<br><b>Unknown:</b> An unknown PD is connected to the port.<br><b>N/A:</b> PoE is disabled for the port. |

| UI Setting                      | Description   |
|---------------------------------|---|
| <b>Configuration Suggestion</b> | <p>Shows configuration suggestions based on detected conditions.</p> <p><b>Disable PoE power output:</b> A NIC or unknown PD was detected; you may want to disable PoE power output for the port.</p> <p><b>Select Force Mode:</b> A higher/lower resistance or higher capacitance was detected; you may want to select <b>Force Mode</b> for the port.</p> <p><b>Select high power output:</b> An unknown classification was detected; you may want to select <b>High Power</b> output for the port.</p> <p><b>Raise the external power supply voltage to greater than 46 VDC:</b> When the external supply voltage is detected as less than 46 V, the system suggests raising the voltage.</p> <p><b>Enable PoE function for detection:</b> The system suggests enabling PoE.</p> <p><b>Select IEEE 802.3at auto mode:</b> When detecting an IEEE 802.3at PD, the system suggests selecting 802.3at Auto mode.</p> <p><b>Select IEEE 802.3af auto mode:</b> When detecting an IEEE 802.3af PD, the system suggests selecting 802.3af Auto mode.</p> |
| <b>PD Failure Check</b>         | <p>Shows the results of the last PD failure check, if checking is enabled. Refer to <a href="#">Network Configuration &gt; Ports &gt; PoE - PD Failure Check</a> for more information.</p> <ul style="list-style-type: none"> <li>• <b>Disable:</b> PD failure checking is not enabled for the port.</li> <li>• <b>Alive:</b> The port is alive, and passed the last PD failure check.</li> <li>• <b>Not Alive:</b> The port is not alive, and failed the last PD failure check.</li> </ul>   |

## Link Fault Passthrough

**Menu Path:** [Network Configuration](#) > [Ports](#) > [Link Fault Passthrough](#)

This page lets you enable and configure the Link Fault Passthrough function.

### Note

Availability of this feature may vary depending on your product model and version.

### Note

When Link Fault Passthrough is enabled, both ports need to be linked up. Otherwise, traffic between LAN ports or access from LAN ports to the device's web console might be shut down.



**Note**

Available ports may vary depending on the model, and port selection may be fixed for some models.

Status \*  
Enabled

Port 1  
1

Port 2  
2

APPLY

| UI Setting    | Description   | Valid Range            | Default Value |
|---------------|---|------------------------|---------------|
| <b>Status</b> | Enable or disable the Link Fault Passthrough function. When enabled, when any of the port links are down, the other port will be shut down. | Enabled / Disabled     | Disabled      |
| <b>Port 1</b> | Specify which port to use as Port 1 in the Link Fault Passthrough pair.   | Dropdown list of ports | 1             |
| <b>Port 2</b> | Specify which port to use as Port 2 in the Link Fault Passthrough pair.   | Dropdown list of ports | 2             |

## LAN Bypass Gen3

**Menu Path: Network Configuration > Ports > LAN Bypass Gen3**

This page lets you enable and configure different LAN bypass modes for your device.

## System Failure Bypass Configuration

### System Failure Bypass Configuration

Mode  
Disabled ▼

APPLY

| UI Setting  | Description  | Valid Range                               | Default Value       |
|-------------|--|---|---------------------|
| <b>Mode</b> | <p>Specify which system failure bypass mode to use. When triggered, system failure bypass allows traffic to continue to flow between LAN ports during system failure events, minimizing disruption and maintaining operational integrity.</p> <p><b>Disabled:</b> Disable system failure bypass. Traffic will not pass between LAN ports during device failure.</p> <p><b>Shutdown:</b> Enable system failure bypass only when there is a hardware failure, such as a power outage.</p> <p><b>Shutdown and Halted:</b> Enable bypass function for both hardware failures and software issues, such as the CPU becoming unresponsive.</p> | Disabled / Shutdown / Shutdown and Halted | Shutdown and Halted |

## System Runtime Bypass Configuration

### System Runtime Bypass Configuration

Status  
Disabled ▼

Auto Recovery Time  
5 i

0 - 43200 min.

APPLY

| UI Setting    | Description  | Valid Range        | Default Value |
|---------------|--|--------------------|---------------|
| <b>Status</b> | <p>Enable/ Disable the system runtime bypass feature. When system runtime bypass is enabled, this will temporarily allow traffic to flow through LAN ports unimpeded, ensuring continuous network operation.</p> | Disabled / Enabled | Disabled      |

| UI Setting                | Description   | Valid Range | Default Value |
|---------------------------|---|-------------|---------------|
| <b>Auto Recovery Time</b> | Specify the number of minutes after which the device will automatically disable system runtime bypass after it is enabled, and will then recover to normal LAN port behavior.<br><br>If this is set to 0, the device will not exit system runtime bypass after it is enabled. | 0 to 43200  | 5             |

## Layer 2 Switching

### Menu Path: Network Configuration > Layer 2 Switching

This section lets you configure the Layer 2 switching settings for your device.

This section includes these pages:

- VLAN
- MAC Address
- QoS
- Rate Limit
- Multicast

## VLAN

### Menu Path: Network Configuration > Layer 2 Switching > VLAN

This page lets you configure global VLAN settings so you can partition your network into separate VLANs.

This page includes these tabs:

- Global
- Settings
- Status

## VLAN Settings - Global

**Menu Path: Network Configuration > Layer 2 Switching > VLAN - Global**

This tab lets you configure the settings for the management VLAN and management port. Click **APPLY** to save your changes.

| UI Setting             | Description  | Valid Range                           | Default Value |
|------------------------|--|---------------------------------------|---------------|
| <b>Management VLAN</b> | Specify the management VLAN ID from the drop-down menu.  | 1 to 4093                             | 1             |
| <b>Management Port</b> | Specify a management port for this device to allow for quick and easy configuration of VLAN settings for multiple ports. | <i>(Depends on your device model)</i> | N/A           |

The following settings will appear after selecting a **Management Port**:

| UI Setting  | Description  | Valid Range             | Default Value |
|-------------|--|-------------------------|---------------|
| <b>Mode</b> | <p>Specify which VLAN mode the port should use:</p> <p><b>Access:</b> Define the port as an Access port. This is used when connecting to single devices without tags.</p> <p><b>Trunk:</b> Define the port as a Trunk port. This is used when connecting to another 802.1Q VLAN-aware router.</p> <p><b>Hybrid:</b> Define the port as a Hybrid port. This is used when connecting to another 802.1Q VLAN-aware router, or another LAN that combines tagged and/or untagged devices and/or other routers or hubs.</p> <div style="background-color: #f0f0f0; padding: 10px; margin-top: 10px;"> <p><b>Note</b></p> <p>If you do not intend to use the device purely as a Layer 2 switch, it is strongly recommended that you do not use trunk VLANs for most use cases.</p> </div> | Access / Trunk / Hybrid | Access        |

| UI Setting           | Description   | Valid Range                  | Default Value                               |
|----------------------|---|------------------------------|---|
| <b>PVID</b>          | Set the default VLAN ID to use for traffic from untagged devices that connect to the port.  | 1 to 4093                    | 1   |
| <b>Tagged VLAN</b>   | If the <b>Mode</b> is set to <b>Trunk</b> or <b>Hybrid</b> , you can specify what VLAN IDs tagged devices that connect to the port will use. Use commas to separate different VLAN IDs. | All Member VLANs / 1 to 4093 | Access mode: N/A<br>Trunk or Hybrid mode: 1 |
| <b>Untagged VLAN</b> | If the <b>Mode</b> is set to <b>Access</b> , assign a VLAN ID for untagged devices that connect to the port and remove tags upon egress. Use commas to separate different VLAN IDs.     | All Member VLANs / 1 to 4093 | Access mode: 1<br>Trunk or Hybrid mode: N/A |

## VLAN - Settings

**Menu Path:** [Network Configuration](#) > [Layer 2 Switching](#) > [VLAN - Settings](#)

This tab lets you configure management VLAN and port settings. Click **APPLY** to save your changes.

### Note

Please note that port numbers may vary depending on product model.

### Limitations

You can create up to 32 VLANs.

**VLAN**

Global Settings Status

+

| <input type="checkbox"/> | VLAN | Member Port                |
|--------------------------|------|----------------------------|
| <input type="checkbox"/> | 1    | 1, 2, 3, 4, 5, 6, 7, 9, 10 |
| <input type="checkbox"/> | 2    | 8                          |
| <input type="checkbox"/> | 40   |                            |
| <input type="checkbox"/> | 50   |                            |
| <input type="checkbox"/> | 4040 |                            |
| <input type="checkbox"/> | 4041 |                            |

Max. 32

↻

|  | Port | Mode   | PVID | Untagged VLAN | Tagged VLAN |
|--|------|--------|------|---------------|-------------|
|  | 3    | Access | 1    | 1,            |             |
|  | 4    | Access | 1    | 1,            |             |
|  | 5    | Access | 1    | 1,            |             |
|  | 6    | Access | 1    | 1,            |             |
|  | 8    | Access | 2    | 2,            |             |
|  | 9    | Access | 1    | 1,            |             |
|  | 10   | Access | 1    | 1,            |             |
|  | Trk1 | Access | 1    | 1,            |             |
|  | Trk2 | Access | 1    | 1,            |             |

The top table shows a list of VLANs.

| UI Setting         | Description                        |
|--------------------|------------------------------------|
| <b>VLAN</b>        | Shows the VID for the VLAN.        |
| <b>Member Port</b> | Shows which ports are in the VLAN. |

The bottom table shows a list of the device's ports and their VLAN settings.

| UI Setting           | Description                          |
|----------------------|--------------------------------------|
| <b>Port</b>          | Shows which port this row describes. |
| <b>Mode</b>          | Shows the VLAN mode for the port.    |
| <b>PVID</b>          | Shows the PVID for the port.         |
| <b>Untagged VLAN</b> | Shows the Untagged VLAN.             |

| UI Setting  | Description            |
|-------------|------------------------|
| Tagged VLAN | Shows the Tagged VLAN. |

## VLAN - Settings - Create VLAN

**Menu Path:** Network Configuration > Layer 2 Switching > VLAN - Settings

Clicking the **Add ( + )** icon on the **Network Configuration > Layer 2 Switching > PoE - Scheduling** page will open this dialog box. This dialog lets you create a VLAN. Click **CREATE** to save your changes and add the new VLAN.

| UI Setting | Description  | Valid Range   | Default Value |
|------------|--|---|---------------|
| <b>VID</b> | Specify the VID to use for the VLAN. You can create multiple VLANs at once by entering single VIDs or VID ranges separated by commas, such as 2, 4-8, 10-13. | 1 to 4094.<br>You can enter multiple VIDs and/or VID ranges, separated by commas. | N/A           |

## VLAN - Settings - Edit Port Settings

**Menu Path:** Network Configuration > Layer 2 Switching > VLAN - Settings

Clicking the **Edit ( ✎ )** icon for a port on the **Network Configuration > Layer 2 Switching > VLAN - Settings** page will open this dialog box. This dialog lets you edit the VLAN settings for a port. Click **APPLY** to save your changes.

**Edit Port 1 Settings**

Mode  
Access ▼

---

PVID  
1 ▼

---

Tagged VLAN  
..... ▼

---

Untagged VLAN  
1 ▼

---

CANCEL APPLY

| UI Setting   | Description  | Valid Range                  | Default Value |
|--|--|------------------------------|---------------|
| <b>Mode</b>  | Specify which VLAN mode the port should use:<br><br><b>Access:</b> Define the port as an Access port. This is used when connecting to single devices without tags.<br><br><b>Trunk:</b> Define the port as a Trunk port. This is used when connecting to another 802.1Q VLAN-aware router.<br><br><b>Hybrid:</b> Define the port as a Hybrid port. This is used when connecting to another 802.1Q VLAN-aware router, or another LAN that combines tagged and/or untagged devices and/or other routers or hubs. | Access / Trunk / Hybrid      | Access        |
| <b>PVID</b>  | Set the default VLAN ID to use for traffic from untagged devices that connect to the port.   | 1 to 4094                    | 1             |
| <b>Tagged VLAN (when editing settings for the Management Port)</b>   | If the <b>Mode</b> is set to <b>Trunk</b> or <b>Hybrid</b> , you can specify what VLAN IDs tagged devices that connect to the port will use. Use commas to separate different VLANs.   | All Member VLANs / 1 to 4094 | N/A           |
| <b>Untagged VLAN (when editing settings for the Management Port)</b> | If the <b>Mode</b> is set to <b>Access</b> , assign a VLAN ID for untagged devices that connect to the port and remove tags upon egress. Use commas to separate different VLAN IDs.  | All Member VLANs / 1 to 4094 | N/A           |

## VLAN - Settings - Delete VLAN

**Menu Path:** Network Configuration > Layer 2 Switching > VLAN - Settings

You can delete VLANs by using the checkboxes to select the VLANs you want to delete, then clicking the **Delete** (  ) icon.



**VLAN**

Global Settings Status

Delete

| VLAN                                   | Member Port                |
|--|----------------------------|
| <input type="checkbox"/> 1             | 1, 2, 3, 4, 5, 6, 7, 9, 10 |
| <input type="checkbox"/> 2             | 8                          |
| <input checked="" type="checkbox"/> 40 |                            |
| <input type="checkbox"/> 50            |                            |
| <input type="checkbox"/> 4040          |                            |
| <input type="checkbox"/> 4041          |                            |

Max. 32

## VLAN - Status

**Menu Path: Network Configuration > Layer 2 Switching > VLAN - Status**

This tab lets you monitor the status of the VLANs on your device.

**VLAN**

Global Settings Status

Search

| VLAN | Hybrid Port | Trunk Port | Access Port             |
|------|-------------|------------|-------------------------|
| 1    |             |            | 1, 2, 3, 4, 5, 6, 9, 10 |
| 2    |             |            | 8                       |
| 3    |             |            | 7                       |
| 4    |             |            |                         |
| 5    |             |            |                         |

1 - 5 of 5

| UI Setting         | Description  |
|--------------------|--|
| <b>VLAN</b>        | Shows the VID of the VLAN.                         |
| <b>Hybrid Port</b> | Shows ports acting as a Hybrid Port for the VLAN.  |
| <b>Trunk Port</b>  | Shows ports acting as a Trunk Port for the VLAN.   |
| <b>Access Port</b> | Shows ports acting as an Access Port for the VLAN. |

## MAC Address Table

**Menu Path: Network Configuration > Layer 2 Switching > MAC Address Table**

This page lets you view your device's MAC address table and set the aging time for MAC address entries.

### MAC Address Table Settings

Aging Time \*

5 - 300 sec.

| UI Setting        | Description   | Valid Range | Default Value |
|-------------------|---|-------------|---------------|
| <b>Aging Time</b> | Specify the aging time for MAC address entries in seconds. The aging time determines how long entries will be kept in the MAC address table in the device's memory before expiring. | 5 to 300    | 300           |

### MAC Address Table

↻
🔍 Search

| Index | VLAN ID | MAC Address       | Type           | Port |
|-------|---------|-------------------|----------------|------|
| 1     | 100     | 00:00:02:00:00:00 | Learnt Unicast | 8    |
| 2     | 100     | 00:0c:29:42:c4:03 | Learnt Unicast | 8    |
| 3     | 100     | 00:90:e8:53:5a:43 | Learnt Unicast | 8    |
| 4     | 100     | 00:90:e8:69:5d:b7 | Learnt Unicast | 8    |
| 5     | 100     | 00:90:e8:6c:5b:21 | Learnt Unicast | 8    |
| 6     | 100     | 00:90:e8:78:69:3b | Learnt Unicast | 8    |

| UI Setting   | Description                                |
|--------------|--|
| <b>Index</b> | Shows the index number of the MAC address. |

| UI Setting         | Description   |
|--------------------|---|
| <b>VLAN ID</b>     | Shows which VLAN ID is being used for the MAC address.  |
| <b>MAC Address</b> | Shows the MAC address.  |
| <b>Type</b>        | Shows what kind of MAC address entry this is:<br><b>Learnt Unicast:</b> Used for all learnt unicast MAC addresses.<br><b>Learnt Multicast:</b> Used for all learnt multicast MAC addresses.<br><b>Static Unicast:</b> Used for all static unicast MAC addresses.<br><b>Static Multicast:</b> Used for all static multicast MAC addresses. |
| <b>Port</b>        | Shows which port on the device the MAC address is connected to.   |

## QoS

### Menu Path: [Network Configuration](#) > [Layer 2 Switching](#) > [QoS](#)

This page lets you configure QoS settings to control network traffic prioritization.









This page includes these tabs:

- CoS Mapping
- DSCP Mapping
- Port Classification

### CoS Mapping

#### Menu Path: [Network Configuration](#) > [Layer 2 Switching](#) > [QoS - CoS Mapping](#)

This tab lets you configure CoS Mapping, which allows you to map 802.1p/1Q Layer 2 CoS tags to priority queues on the device.

| QoS   |                |                     |
|---|----------------|---------------------|
| CoS Mapping   | DSCP Mapping   | Port Classification |
| CoS   | Priority Queue |                     |
|  0 | 0              |                     |
|  1 | 0              |                     |
|  2 | 1              |                     |
|  3 | 1              |                     |
|  4 | 2              |                     |
|  5 | 2              |                     |
|  6 | 3              |                     |
|  7 | 3              |                     |

| UI Setting   | Description  |
|--------------|--|
| <b>CoS</b>   | Shows the CoS level. Higher numbers indicate higher priority.      |
| <b>Level</b> | Shows the priority queue. Higher numbers indicate higher priority. |

### CoS Mapping - Edit a CoS Mapping

#### Menu Path: Network Configuration > Layer 2 Switching > QoS - CoS Mapping

Clicking the **Edit** (  ) icon for an CoS level on the **Network Configuration > Layer 2 Switching > QoS - CoS Mapping** tab will open this dialog box. This dialog lets you map CoS levels to priority queues. Click **APPLY** to save your changes.

**Edit CoS 0 Settings**

Priority Queue \*

0 ▼

CANCEL APPLY

| UI Setting            | Description   | Valid Range                                     | Default Value |
|-----------------------|---|---|---------------|
| <b>Priority Queue</b> | Specify the priority queue to use for the CoS level. Higher numbers indicate higher priority. | 0 to 3<br><i>(Depends on your device model)</i> | 0             |

## DSCP Mapping

**Menu Path: Network Configuration > Layer 2 Switching > QoS - DSCP Mapping**

This tab lets you map Layer 3 DSCP levels to priority queues on the device.

| DSCP      | Level |
|-----------|-------|
| 0x0 (1)   | 0     |
| 0x4 (2)   | 0     |
| 0x8 (3)   | 0     |
| 0xc (4)   | 0     |
| 0x10 (5)  | 0     |
| 0x14 (6)  | 0     |
| 0x18 (7)  | 0     |
| 0x1c (8)  | 0     |
| 0x20 (9)  | 0     |
| 0x24 (10) | 0     |
| 0x28 (11) | 0     |
| 0x2c (12) | 0     |
| 0x30 (13) | 0     |
| 0x34 (14) | 0     |
| 0x38 (15) | 0     |
| 0x3c (16) | 0     |
| 0x40 (17) | 1     |

| UI Setting   | Description  |
|--------------|--|
| <b>DSCP</b>  | Shows the DSCP level. Higher numbers indicate higher priority.     |
| <b>Level</b> | Shows the priority queue. Higher numbers indicate higher priority. |

## DSCP Mapping - Edit a DSCP Mapping

### Menu Path: Network Configuration > Layer 2 Switching > QoS - DSCP Mapping

Clicking the **Edit** (✎) icon for an DSCP mapping on the **Network Configuration > Layer 2 Switching > QoS - DSCP Mapping** page will open this dialog box. This dialog lets you map DSCP levels to priority queues. Click **APPLY** to save your changes.

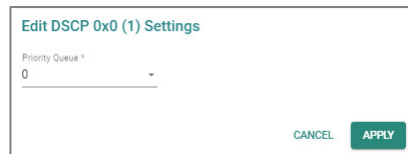

| UI Setting            | Description  | Valid Range                                     | Default Value |
|-----------------------|--|---|---------------|
| <b>Priority Queue</b> | Specify the priority queue to use for the DSCP level. Higher numbers indicate higher priority. | 0 to 3<br><i>(Depends on your device model)</i> | 0             |

## Port Classification

### Menu Path: Network Configuration > Layer 2 Switching > QoS - Port Classification

This tab lets you set up QoS queueing mechanisms.

#### ✎ Note

For TN-4900 Series 16-port models, port priority must be handled in 2 separate groups as follows, due to design limitations:

- Ports 1 to 8
- Ports G1 to G8  
or  
Ports 9 to 12 and G1 to G4  
(depends on your model)

**QoS**

CoS Mapping    DSCP Mapping    **Port Classification**

Scheduling Mechanism \*  
Weight Fair(8:4:2:1) ▼

**APPLY**

Q Search

| Port | Inspect ToS | Inspect CoS | Priority |
|------|-------------|-------------|----------|
| 3    | Enabled     | Enabled     | 3        |
| 4    | Enabled     | Enabled     | 3        |
| 5    | Enabled     | Enabled     | 3        |
| 6    | Enabled     | Enabled     | 3        |
| 8    | Enabled     | Enabled     | 3        |
| G1   | Enabled     | Enabled     | 3        |
| G2   | Enabled     | Enabled     | 3        |
| Trk1 | Enabled     | Enabled     | 3        |
| Trk2 | Enabled     | Enabled     | 3        |

1 - 9 of 9

| UI Setting                  | Description  | Valid Range   | Default Value        |
|-----------------------------|--|---|----------------------|
| <b>Scheduling Mechanism</b> | <p>Specify the scheduling mechanism to use for your device:</p> <p><b>Weight Fair(8:4:2:1):</b> In the weight fair scheme, an 8, 4, 2, 1 weighting is applied to the four priority levels on the device. This approach prevents lower priority frames from being starved of opportunities for transmission with only a slight delay to higher priority frames.</p> <p><b>Strict(High Priority First Always):</b> In the strict-priority scheme, all top-priority frames egress a port until that priority's queue is empty, and then the next lower priority queue's frames egress. This approach can cause the lower priorities to be starved of opportunities for transmitting any frames, but ensures that all high priority frames will egress the switch as soon as possible.</p> | Weight Fair(8:4:2:1) / Strict(High Priority First Always) | Weight Fair(8:4:2:1) |

The port classification table shows the following information:

| UI Setting         | Description   |
|--------------------|---|
| <b>Port</b>        | Shows which port this row describes.                              |
| <b>Inspect ToS</b> | Shows whether ToS is enabled or disabled for the port.            |
| <b>Inspect CoS</b> | Shows whether CoS inspection is enabled or disabled for the port. |

| UI Setting      | Description   |
|-----------------|---|
| <b>Priority</b> | Shows the priority for the port. Higher numbers indicate higher priority. |

## Port Classification - Edit Port Setting

### Menu Path: Network Configuration > Layer 2 Switching > QoS - Port Classification

Clicking the **Edit** (✎) icon for a port on the **Network Configuration > Layer 2 Switching > QoS - Port Classification** page will open this dialog box. This dialog lets you adjust the QoS classification settings for each port. Click **APPLY** to save your changes.

**Edit Port 3 Settings**

Inspect ToS\*

Inspect CoS\*

Priority\*

CANCEL APPLY

| UI Setting         | Description   | Valid Range         | Default Value |
|--------------------|---|---------------------|---------------|
| <b>Inspect ToS</b> | Enable or disable inspection of Type of Service (ToS) bits in the IPV4 frame to determine the priority of each frame. | Enabled or Disabled | Enabled       |
| <b>Inspect CoS</b> | Enable or disable inspection of 802.1p CoS tags in the MAC frame to determine the priority of each frame.             | Enabled or Disabled | Enabled       |
| <b>Priority</b>    | Specify the priority of the port. Higher numbers indicate higher priority.  | 0 to 7              | 3             |



# Rate Limit

## Menu Path: Network Configuration > Layer 2 Switching > Rate Limit

This page lets you control the bandwidth of ingress (incoming) and egress (outgoing) traffic through the device to protect end-devices that may not have the capability to handle large amounts of traffic.

### Note

Please note that available options may vary depending on the product model.

### Rate Limit







Ingress Policy \*  
Limit Broadcast

Ingress Action \*  
Drop Packet

**APPLY**

---

🔍 Search

| Port   | Ingress                 | Egress                  |
|--|-------------------------|-------------------------|
|  3  | Not Limited (100 Mbps)  | Not Limited (100 Mbps)  |
|  4  | Not Limited (1000 Mbps) | Not Limited (1000 Mbps) |
|  5  | Not Limited (1000 Mbps) | Not Limited (1000 Mbps) |
|  6  | Not Limited (100 Mbps)  | Not Limited (100 Mbps)  |
|  8  | Not Limited (1000 Mbps) | Not Limited (1000 Mbps) |
|  G1 | Not Limited (1000 Mbps) | Not Limited (1000 Mbps) |
|  G2 | Not Limited (1000 Mbps) | Not Limited (1000 Mbps) |

1 - 7 of 7

## Rate Limit Settings

Ingress Policy \*  
Limit Broadcast

Ingress Action \*  
Drop Packet

**APPLY**

### Rate Limit

Ingress Policy \*  
Limit Broadcast

---

Ingress Action \*  
Port Disable







Port Disable Period \*  
0

1 - 65535

APPLY

| UI Setting  | Description  | Valid Range   | Default Value   |
|---|--|---|-----------------|
| <b>Ingress Policy</b>   | <p>Select which kind of traffic ingress rate limiting will be applied to.</p> <p><b>Limit All:</b> Rate limit will be applied to all traffic.</p> <p><b>Limit Broadcast, Multicast and Flooded Unicast:</b> Rate limit will be applied to broadcast, multicast, and flooded unicast traffic only.</p> <p><b>Limit Broadcast, Multicast:</b> Rate limit will be applied to broadcast and multicast traffic only.</p> <p><b>Limit Broadcast:</b> Rate limit will be applied to broadcast traffic only.</p> | Limit All / Limit Broadcast, Multicast and Flooded Unicast / Limit Broadcast, Multicast / Limit Broadcast | Limit Broadcast |
| <b>Ingress Action</b>   | <p>Select the ingress action.</p> <p><b>Drop Packet:</b> The rate limit will discard incoming packets that do not comply with the ingress policy.</p> <p><b>Port Disable:</b> The rate limit will disable the port that do not comply with the ingress policy.</p>   | Drop Packet / Port Disable  | Drop Pakcet     |
| <b>Port Disabled Period</b><br><b>(Only if Ingress Action is set as Port Disable)</b> | <p>Select the port disable period during which the port will be disabled. Once this period is over, the port will be re-enabled. However, if the port does not comply with the ingress policy again, it will be disabled then.</p>   | 1-65535   | 0               |

## Rate Limit Port List

| Port   | Ingress                 | Egress                  |
|--|-------------------------|-------------------------|
|  3  | Not Limited (100 Mbps)  | Not Limited (100 Mbps)  |
|  4  | Not Limited (1000 Mbps) | Not Limited (1000 Mbps) |
|  5  | Not Limited (1000 Mbps) | Not Limited (1000 Mbps) |
|  6  | Not Limited (100 Mbps)  | Not Limited (100 Mbps)  |
|  8  | Not Limited (1000 Mbps) | Not Limited (1000 Mbps) |
|  G1 | Not Limited (1000 Mbps) | Not Limited (1000 Mbps) |
|  G2 | Not Limited (1000 Mbps) | Not Limited (1000 Mbps) |

1 - 7 of 7

| UI Setting     | Description  |
|----------------|--|
| <b>Port</b>    | Shows which port this row describes.                         |
| <b>Ingress</b> | Shows the ingress bandwidth rate limit method and bandwidth. |
| <b>Egress</b>  | Shows the egress bandwidth rate limit method and bandwidth.  |

### Rate Limit - Edit Port Settings

#### Menu Path: Network Configuration > Layer 2 Switching > Rate Limit

Clicking the **Edit** (  ) icon for a port on the **Network Configuration > Layer 2 Switching > Rate Limit** page will open this dialog box. This dialog lets you configure rate limit settings for each port. Click **APPLY** to save your changes.

**Edit Port 1/1 Settings**

Ingress \*

Egress \*

| UI Setting     | Description   | Valid Range  | Default Value |
|----------------|---|--|---------------|
| <b>Ingress</b> | Select the ingress rate limit (% of max. throughput) for all packets. | Not Limited / 3% / 5% / 10% /15% / 25% / 35% / 50% / 65% / 85% | Not Limited   |

| UI Setting    | Description  | Valid Range  | Default Value |
|---------------|--|--|---------------|
| <b>Egress</b> | Select the egress rate limit (% of max. throughput) for all packets. | Not Limited / 3% / 5% / 10% /15% / 25% / 35% / 50% / 65% / 85% | Not Limited   |

## Multicast

**Menu Path:** [Network Configuration](#) > [Layer 2 Switching](#) > [Multicast](#)

This section lets you adjust various settings for handling multicast traffic.

This section includes these pages:

- [IGMP Snooping](#)
- [Static Multicast Table](#)

### IGMP Snooping

**Menu Path:** [Network Configuration](#) > [Layer 2 Switching](#) > [Multicast](#) > [IGMP Snooping](#)

This page lets you configure IGMP snooping, which enables intelligent forwarding of multicast traffic in local area networks (LANs). By listening to IGMP messages sent between hosts and multicast routers, IGMP snooping can learn which multicast groups are active on the network and maintain a database of multicast group membership.

This page includes these tabs:

- [VLAN Settings](#)
- [Group Table](#)
- [Forwarding Table](#)

**IGMP Snooping**

VLAN Settings    Group Table    Forwarding Table

Query Interval \*  
125  
20 - 600    sec.

**APPLY**

↻

| VLAN ID | IGMP Snooping | Querier | Static Router Port |
|---------|---------------|---------|--------------------|
| 1       | Disabled      | V1/V2   | --                 |
| 2       | Disabled      | V1/V2   | --                 |
| 3       | Disabled      | V1/V2   | --                 |
| 4       | Disabled      | V1/V2   | --                 |
| 5       | Disabled      | V1/V2   | --                 |

## VLAN Settings

**Menu Path: Network Configuration > Layer 2 Switching > Multicast > IGMP Snooping - VLAN Settings**

This tab lets you configure IGMP snooping settings for each VLAN.

**IGMP Snooping**

VLAN Settings    Group Table    Forwarding Table

Query Interval \*  
125  
20 - 600    sec.

**APPLY**

↻

| VLAN ID | IGMP Snooping | Querier | Static Router Port |
|---------|---------------|---------|--------------------|
| 1       | Disabled      | V1/V2   | --                 |
| 2       | Disabled      | V1/V2   | --                 |
| 3       | Disabled      | V1/V2   | --                 |
| 4       | Disabled      | V1/V2   | --                 |
| 5       | Disabled      | V1/V2   | --                 |

## IGMP VLAN Settings

### IGMP Snooping

VLAN Settings
Group Table
Forwarding Table

Query Interval \*  
125  
20 - 600 sec.

APPLY

↻

| VLAN ID | IGMP Snooping | Querier | Static Router Port |
|---------|---------------|---------|--------------------|
| 1       | Disabled      | V1/V2   | --                 |
| 2       | Disabled      | V1/V2   | --                 |
| 3       | Disabled      | V1/V2   | --                 |
| 4       | Disabled      | V1/V2   | --                 |
| 5       | Disabled      | V1/V2   | --                 |

| UI Setting            | Description  | Valid Range       | Default Value |
|-----------------------|--|-------------------|---------------|
| <b>Query Interval</b> | Specify the query interval of the querier function globally. | 20 to 600 seconds | 125 seconds   |

## IGMP VLAN List

### IGMP Snooping

VLAN Settings
Group Table
Forwarding Table

Query Interval \*  
125  
20 - 600 sec.

APPLY

↻

| VLAN ID | IGMP Snooping | Querier | Static Router Port |
|---------|---------------|---------|--------------------|
| 1       | Disabled      | V1/V2   | --                 |
| 2       | Disabled      | V1/V2   | --                 |
| 3       | Disabled      | V1/V2   | --                 |
| 4       | Disabled      | V1/V2   | --                 |
| 5       | Disabled      | V1/V2   | --                 |

| UI Setting                | Description  |
|---------------------------|--|
| <b>VLAN ID</b>            | Shows which VLAN ID this row describes.  |
| <b>IGMP Snooping</b>      | Shows whether IGMP snooping is enabled or disabled for the VLAN.                                     |
| <b>Querier</b>            | Shows which version of IGMP snooping the VLAN will use.  |
| <b>Static Router Port</b> | Shows the static router port the VLAN will use to connect to the multicast router for IGMP snooping. |

## VLAN Settings - Edit VLAN Settings

### Menu Path: Network Configuration > Layer 2 Switching > Multicast > IGMP Snooping - VLAN Settings

Clicking the **Edit** (✎) icon for a VLAN on the **Network Configuration > Layer 2 Switching > Multicast > IGMP Snooping - VLAN Settings** page will open this dialog box. This dialog lets you enable and configure IGMP snooping for each VLAN. Click **APPLY** to save your changes.

| UI Setting           | Description   | Valid Range        | Default Value |
|----------------------|---|--------------------|---------------|
| <b>IGMP Snooping</b> | Enable or disable IGMP Snooping function for the VLAN.  | Enabled / Disabled | Disabled      |
| <b>Version</b>       | Specify which version of IGMP snooping to use:<br><b>V1/V2:</b> Enable the Moxa device to send IGMP snooping version 1 and 2 queries.<br><b>V3:</b> Enable the Moxa device to send IGMP snooping version 3 queries. | V1/V2 / V3         | V1/V2         |

| UI Setting                | Description  | Valid Range  | Default Value |
|---------------------------|--|--|---------------|
| <b>Static Router Port</b> | Select which ports will be used to connect to multicast routers for IGMP Snooping. The device will receive all multicast packets from the selected ports.<br><br><div style="border: 1px solid #ccc; padding: 5px; background-color: #f9f9f9;"> <p><b>Note</b></p> <p>If a router or Layer 3 switch is connected to the network, it will act as the querier, and the querier function will be disabled on all Moxa Layer 2 switches.</p> <p>If all switches on the network are Moxa Layer 2 switches, then only one Layer 2 switch will act as the querier.</p> </div> | 1/1 / 1/2 / 1/3 / 1/4 / 1/5 / 1/6 / 1/7 / 1/8 / 1/9 / 1/10 | N/A           |

## Group Table

**Menu Path: Network Configuration > Layer 2 Switching > Multicast > IGMP Snooping - Group Table**

This tab lets you see all currently active IGMP groups that were detected for each VLAN.

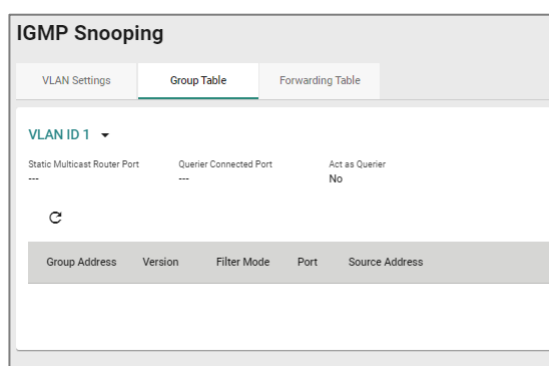

## VLAN Group Table List

You can use the VLAN drop-down to select which VLAN's group table is displayed.

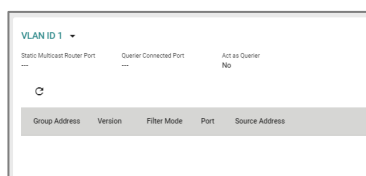



| UI Setting                          | Description  |
|-------------------------------------|--|
| <b>Static Multicast Router Port</b> | Shows the static multicast querier port(s) for the VLAN.   |
| <b>Querier Connected Port</b>       | Shows the port which is connected to the querier for the VLAN.                                       |
| <b>Act as a Querier</b>             | Shows whether or not this VLAN has been selected to act as a querier.                                |
| <b>Group Address</b>                | Shows the multicast group addresses for the VLAN.  |
| <b>Version</b>                      | Shows the IGMP snooping version for the group address.   |
| <b>Filter Mode</b>                  | If IGMP v3 is enabled for the VLAN ID, this shows whether the group address is Included or Excluded. |
| <b>Port</b>                         | Shows which ports are members of the group address.  |
| <b>Source Address</b>               | When IGMP v3 is enabled, this shows the multicast source address for the group address.              |

## Forwarding Table

### Menu Path: Network Configuration > Layer 2 Switching > Multicast > IGMP Snooping - Forwarding Table

This page lets you see the multicast stream forwarding status for each VLAN.

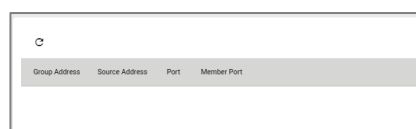
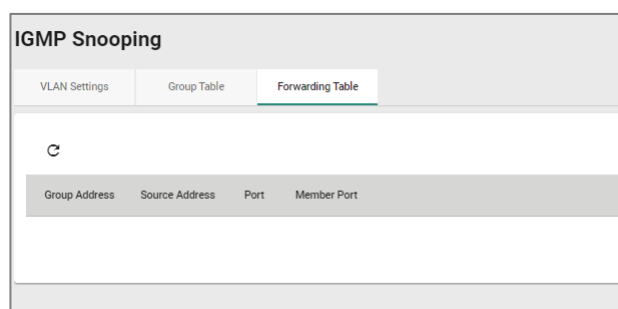

| UI Setting           | Description                           |
|----------------------|---------------------------------------|
| <b>Group Address</b> | Shows the multicast group IP address. |

| UI Setting            | Description   |
|-----------------------|---|
| <b>Source Address</b> | Shows the IP address the multicast group will receive multicast streams from. |
| <b>Port</b>           | Shows the port receiving the multicast stream.                                |
| <b>Member Port</b>    | Shows the port the multicast stream is forwarded to.                          |

## Static Multicast Table

### Menu Path: Network Configuration > Layer 2 Switching > Multicast > Static Multicast Table

This page lets you manage your device's static multicast entries.

#### Note

Please note that settings and available options will vary depending on the product model.

#### Note

Moxa's Router Series devices manage MAC address learning for VLANs using IVL (Independent VLAN Learning), which uses separate MAC address tables for each VLAN so that MAC address learning for different VLANs do not interfere with each other. This allows the same MAC address to be used in multiple VLANs without causing forwarding issues.

This may lead to a larger MAC address table size, as each VLAN maintains its own individual address table, and the number of MAC address entries will increase based on the number of VLAN member ports used.

#### Limitations

You can create up to 256 static multicast entries, though some models may support up to 1000 static multicast entries.

The number of entries is calculated as follows: Number of MAC address entries \* Number of VLAN IDs

For example, if the static multicast table contains 30 MAC addresses and is connected to 4 VLAN IDs, then the number of MAC address entries would be 30 MAC addresses \* 4 VLAN IDs = 120 static multicast entries.

| Static Multicast Table  |         |  |      |
|---|---------|--|------|
|  |         | Search                                 |      |
| <input type="checkbox"/>  | VLAN ID | MAC Address                            | Port |
| <input type="checkbox"/>  | 1       | 01:00:5e:01:02:03                      | 8    |
| <input type="checkbox"/>  | 1       | 01:00:5e:7f:ff:ff                      |      |
| <input type="checkbox"/>  | 1       | 01:00:5e:7f:ff:ff                      | 3    |
| Max. 256  |         | Items per page: 50 1 - 3 of 3  < < > > |      |

| UI Setting         | Description  |
|--------------------|--|
| <b>VLAN ID</b>     | Shows the VLAN ID used for the static multicast entry.         |
| <b>MAC Address</b> | Shows the MAC address used for the static multicast entry.     |
| <b>Port</b>        | Shows which ports are included for the static multicast entry. |

## Static Multicast Table - Create Static Multicast

### Menu Path: Network Configuration > Layer 2 Switching > Multicast > Static Multicast Table

Clicking the **Add** () icon on the **Network Configuration > Layer 2 Switching > Multicast > Static Multicast Table** page will open this dialog box. This dialog lets you add a static multicast entry. Click **CREATE** to save your changes and add the new static multicast entry.

#### Note

01:00:5E:XX:XX:XX on this page is the IP multicast MAC address, please activate IGMP Snooping for automatic classification.

### Create Static Multicast

VLAN ID \*

MAC Address \*  i

Port \*

CANCEL CREATE

| UI Setting         | Description  | Valid Range                 | Default Value |
|--------------------|--|-----------------------------|---------------|
| <b>VLAN ID</b>     | Specify the VLAN ID.   | Drop-down list of VLAN ID   | N/A           |
| <b>MAC Address</b> | Specify the static multicast MAC address.                              | Valid multicast MAC address | N/A           |
| <b>Port</b>        | Specify which ports you want to include in the static multicast group. | Drop-down list of ports     | N/A           |

### Static Multicast Table - Edit Static Multicast

#### Menu Path: Network Configuration > Layer 2 Switching > Multicast > Static Multicast Table

Clicking the **Edit (✎)** icon for an account on the **Network Configuration > Layer 2 Switching > Multicast > Static Multicast Table** page will open this dialog box. This dialog lets you edit an existing static multicast entry. Click **APPLY** to save your changes.

### Edit Static Multicast

VLAN ID \*

MAC Address \*  i

Port \*

CANCEL APPLY

| UI Setting     | Description          | Valid Range               | Default Value |
|----------------|----------------------|---------------------------|---------------|
| <b>VLAN ID</b> | Specify the VLAN ID. | Drop-down list of VLAN ID | N/A           |

| UI Setting         | Description  | Valid Range                 | Default Value |
|--------------------|--|-----------------------------|---------------|
| <b>MAC Address</b> | Specify the static multicast MAC address.                              | Valid multicast MAC address | N/A           |
| <b>Port</b>        | Specify which ports you want to include in the static multicast group. | Drop-down list of ports     | N/A           |

## Static Multicast Table - Delete Static Multicast

**Menu Path:** [Network Configuration](#) > [Layer 2 Switching](#) > [Multicast](#) > [Static Multicast Table](#)

You can delete user accounts by using the checkboxes to select the accounts you want to delete, then clicking the **Delete** (  ) icon.

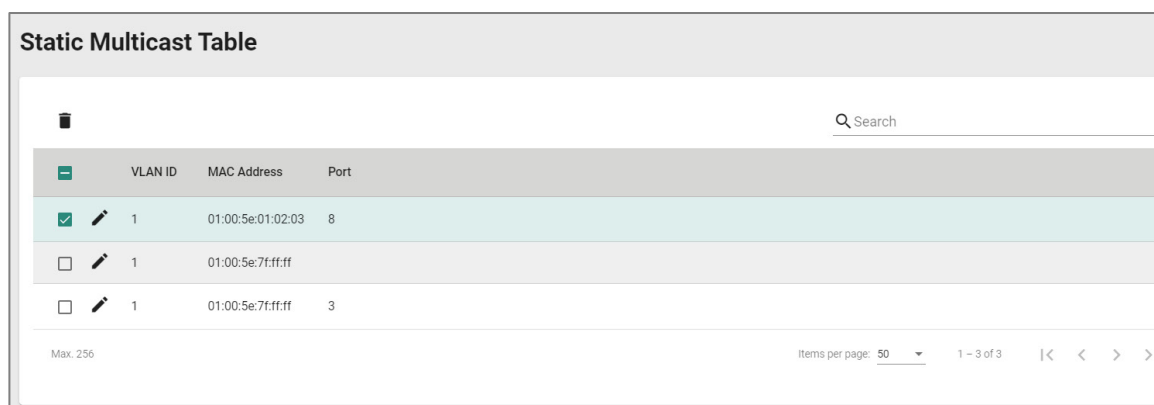

| Static Multicast Table              |         |                   |      |
|-------------------------------------|---------|-------------------|------|
|                                     | VLAN ID | MAC Address       | Port |
| <input checked="" type="checkbox"/> | 1       | 01:00:5e:01:02:03 | 8    |
| <input type="checkbox"/>            | 1       | 01:00:5e:7f:ff:ff |      |
| <input type="checkbox"/>            | 1       | 01:00:5e:7f:ff:ff | 3    |

Max. 256      Items per page: 50      1 - 3 of 3      |< < > >|

## Network Interfaces

**Menu Path:** [Network Configuration](#) > [Network Interfaces](#)

This page lets you configure the settings for the various interfaces of your device.

This page includes these tabs:

- LAN
- WAN/WAN1
- WAN2/DMZ
- Bridge

- MTU Configuration
- Secondary IP
- Virtual Interface

**Network Interfaces**

LAN    WAN    Bridge    MTU Configuration    Secondary IP    Virtual Interface

Search

| <input type="checkbox"/> | Name      | Status   | VLAN ID | Alias | IP Address      | Netmask       | Virtual MAC | Directed Broadcast | Source IP Overwrite |
|--------------------------|-----------|----------|---------|-------|-----------------|---------------|-------------|--------------------|---------------------|
| <input type="checkbox"/> | LAN       | Enabled  | 1       |       | 192.168.127.254 | 255.255.255.0 | --          | Disabled           | Disabled            |
| <input type="checkbox"/> | lan1      | Enabled  | 40      |       | 192.168.126.254 | 255.255.255.0 | --          | Disabled           | Disabled            |
| <input type="checkbox"/> | lan_test  | Enabled  | 50      |       | 192.168.125.29  | 255.255.255.0 | --          | Disabled           | Disabled            |
| <input type="checkbox"/> | lan_test2 | Disabled | 4040    |       | 192.168.9.2     | 255.255.255.0 | --          | Disabled           | Disabled            |

Max. 16    Items per page: 50    1 - 4 of 4    < > >>

## LAN

### Menu Path: Network Configuration > Network Interfaces - LAN

This tab lets you manage your LAN interfaces.



#### Limitations

You can create up to 16 LAN interfaces by configuring each port with unique VLAN ID numbers.

#### Note

For the TN-4900 Series, when the Connection Type is set to Dynamic IP for an interface, the interface's information including the IP and the file name/file server (Option 66/67) can be checked through the CLI interface.

## Network Interfaces List

| Network Interfaces  |  |         |                   |              |                 |               |             |                    |                     |
|---|--|---------|-------------------|--------------|-----------------|---------------|-------------|--------------------|---------------------|
| LAN   | WAN  | Bridge  | MTU Configuration | Secondary IP |                 |               |             |                    |                     |
|  |  |         |                   |              |                 |               |             |                    |                     |
| <input type="checkbox"/>  | Name   | Status  | VLAN ID           | Alias        | IP Address      | Netmask       | Virtual MAC | Directed Broadcast | Source IP Overwrite |
| <input type="checkbox"/>  |  LAN  | Enabled | 1                 | 0            | 192.168.127.254 | 255.255.255.0 | --          | Disabled           | Disabled            |
| <input type="checkbox"/>  |  lan2 | Enabled | 3                 |              | 192.168.126.1   | 255.255.255.0 | --          | Disabled           | Disabled            |
| Max. 16   |  |         |                   |              |                 |               |             |                    |                     |

| UI Setting                 | Description   |
|----------------------------|---|
| <b>Name</b>                | Shows the name of the interface.                                |
| <b>Status</b>              | Shows the status of the interface.                              |
| <b>VLAN ID</b>             | Shows the VLAN ID used for the interface.                       |
| <b>Alias</b>               | Shows the alias for the interface.                              |
| <b>IP Address</b>          | Shows the IP address of the interface.                          |
| <b>Netmask</b>             | Shows the subnet mask of the interface.                         |
| <b>Virtual MAC</b>         | Shows the virtual MAC address of the interface.                 |
| <b>Directed Broadcast</b>  | Shows whether directed broadcast is enabled for the interface.  |
| <b>Source IP Overwrite</b> | Shows whether source IP overwrite is enabled for the interface. |

### LAN - Create LAN Interface Entry

#### Menu Path: [Network Configuration](#) > [Network Interfaces - LAN](#)

Clicking the **Add** () icon on the **Network Configuration > Network Interfaces - LAN** page will open this dialog box. This dialog lets you create new LAN interface entries for your device. Click **CREATE** to save your changes and add the new interface.

### **🔔 Limitations**

You can create up to 16 LAN interfaces by configuring each port with unique VLAN ID numbers.

### **📌 Note**

The VLAN ID of the first LAN interface configured will be set as the management VLAN ID.

#### Create LAN Interface Entry

Name \*  
\_\_\_\_\_ 0 / 12

VLAN Interface \*  
Enabled ▾

VLAN ID \*  
\_\_\_\_\_ 1 - 4094

Alias  
\_\_\_\_\_ 0 / 31

Proxy ARP  
Disabled ▾

Connection Type \*  
Static IP ▾

Directed Broadcast \* ▾ Source IP Overwrite  
Disabled ▾ Disabled ▾

IP Address \* \_\_\_\_\_ Netmask \*  
24 (255.255.255.0) ▾

Virtual MAC  
00:00:00:00:00:00  
\_\_\_\_\_

CANCEL CREATE

| UI Setting            | Description                           | Valid Range        | Default Value |
|-----------------------|---------------------------------------|--------------------|---------------|
| <b>Name</b>           | Specify a name for the interface.     | 1 to 12 characters | N/A           |
| <b>VLAN Interface</b> | Enable or disable the VLAN interface. | Enabled / Disabled | Enabled       |



| UI Setting   | Description  | Valid Range            | Default Value      |
|--|--|------------------------|--------------------|
| <b>VLAN ID</b>   | Specify the VLAN ID.   | 1 to 4094              | N/A                |
| <b>Alias</b>   | Specify an alias for the VLAN interface.   | 1 to 31 characters     | N/A                |
| <b>Proxy ARP</b>   | Enable or disable proxy ARP for the interface.   | Enabled / Disabled     | Disabled           |
| <b>Connection Type</b>   | Select the connection type for the interface.  | Static IP / Dynamic IP | Static IP          |
|  | <p> <b>Note</b></p> <p>The LAN interfaces require static IP addresses; dynamic IPs are not supported.</p> |                        |                    |
| <b>Directed Broadcast</b>  | Enable or disable directed broadcast for the interface.  | Enabled / Disabled     | Disabled           |
| <b>Source IP Overwrite</b>   | Enable or disable source IP overwrite for the interface.   | Enabled / Disabled     | Disabled           |
| <b>IP Address</b><br>(Only when Connection Type set as Static IP)                | Specify the IP address of the interface.   | Valid IP address       | N/A                |
| <b>Netmask</b><br>(Only when Connection Type set as Static IP)                   | Specify the subnet mask of the interface.  | Valid subnet mask      | 24 (255.255.255.0) |
| <b>DHCP Client Option 66/67</b><br>(Only when Connection Type set as Dynamic IP) | Enable or disable DHCP Client Option 66/67 for the interface, if the device supports it.   | Enabled / Disabled     | Disabled           |
| <b>Virtual MAC</b>   | Specify the virtual MAC address of the interface.  | Valid MAC address      | 00:00:00:00:00:00  |

## LAN - Edit LAN Interface Entry

### Menu Path: Network Configuration > Network Interfaces - LAN

Clicking the **Edit** (  ) icon on the **Network Configuration > Network Interfaces - LAN** page will open this dialog box. This dialog lets you edit an existing LAN interface entry for your device. Click **SAVE** to save your changes.

## Edit LAN Interface Entry

Name \*  
 LAN 3 / 12

VLAN Interface \*  
 Enabled ▼

VLAN ID \*  
 1 ▼  
 1 - 4094

Alias 0 / 31

Directed Broadcast \*  
 Disabled ▼

Source IP Overwrite  
 Disabled ▼

IP Address \*  
 192.168.127.254

Netmask \*  
 24 (255.255.255.0) ▼

Virtual MAC  
 00:00:00:00:00:00

CANCEL

APPLY

| UI Setting            | Description                                    | Valid Range        | Default Value |
|-----------------------|--|--------------------|---------------|
| <b>Name</b>           | Specify a name for the interface.              | 1 to 12 characters | N/A           |
| <b>VLAN Interface</b> | Enable or disable the VLAN interface.          | Enabled / Disabled | Enabled       |
| <b>VLAN ID</b>        | Specify the VLAN ID.                           | 1 to 4094          | N/A           |
| <b>Alias</b>          | Specify an alias for the VLAN interface.       | 1 to 31 characters | N/A           |
| <b>Proxy ARP</b>      | Enable or disable proxy ARP for the interface. | Enabled / Disabled | Disabled      |

| UI Setting   | Description   | Valid Range            | Default Value         |
|--|---|------------------------|-----------------------|
| <b>Connection Type</b>   | Select the connection type for the interface.<br><br><div style="border: 1px solid #ccc; background-color: #f9f9f9; padding: 5px; margin: 5px 0;"> <p> <b>Note</b><br/>The LAN interfaces require static IP addresses; dynamic IPs are not supported.</p> </div> | Static IP / Dynamic IP | Static IP             |
| <b>Directed Broadcast</b>  | Enable or disable directed broadcast for the interface.   | Enabled / Disabled     | Disabled              |
| <b>Source IP Overwrite</b>   | Enable or disable source IP overwrite for the interface.  | Enabled / Disabled     | Disabled              |
| <b>IP Address</b><br>(Only when Connection Type set as Static IP)                | Specify the IP address of the interface.  | Valid IP address       | N/A                   |
| <b>Netmask</b><br>(Only when Connection Type set as Static IP)                   | Specify the subnet mask of the interface.   | Valid subnet mask      | 24<br>(255.255.255.0) |
| <b>DHCP Client Option 66/67</b><br>(Only when Connection Type set as Dynamic IP) | Enable or disable DHCP Client Option 66/67 for the interface, if the device supports it.  | Enabled / Disabled     | Disabled              |
| <b>Virtual MAC</b>   | Specify the virtual MAC address of the interface.   | Valid MAC address      | 00:00:00:00:00:00     |

## Delete LAN Interface Entry

### Menu Path: Network Configuration > Network Interfaces - LAN

You can delete interfaces by using the checkboxes to select the interfaces you want to delete, then clicking the **Delete** (  ) icon.

| Network Interfaces  |         |         |       |                 |               |                   |                    |                     |  |      |        |         |       |            |         |             |                    |                     |                              |         |   |   |                 |               |    |          |          |  |         |   |  |               |               |    |          |          |
|---|---------|---------|-------|-----------------|---------------|-------------------|--------------------|---------------------|--|------|--------|---------|-------|------------|---------|-------------|--------------------|---------------------|------------------------------|---------|---|---|-----------------|---------------|----|----------|----------|--|---------|---|--|---------------|---------------|----|----------|----------|
| LAN   |         | WAN     |       | Bridge          |               | MTU Configuration |                    | Secondary IP        |  |      |        |         |       |            |         |             |                    |                     |                              |         |   |   |                 |               |    |          |          |  |         |   |  |               |               |    |          |          |
| <div style="display: flex; align-items: center;"> <span style="margin-right: 10px;">Delete</span> <table border="1"> <thead> <tr> <th>Name</th> <th>Status</th> <th>VLAN ID</th> <th>Alias</th> <th>IP Address</th> <th>Netmask</th> <th>Virtual MAC</th> <th>Directed Broadcast</th> <th>Source IP Overwrite</th> </tr> </thead> <tbody> <tr> <td><input type="checkbox"/> LAN</td> <td>Enabled</td> <td>1</td> <td>0</td> <td>192.168.127.254</td> <td>255.255.255.0</td> <td>--</td> <td>Disabled</td> <td>Disabled</td> </tr> <tr> <td><input checked="" type="checkbox"/> lan2</td> <td>Enabled</td> <td>3</td> <td></td> <td>192.168.126.1</td> <td>255.255.255.0</td> <td>--</td> <td>Disabled</td> <td>Disabled</td> </tr> </tbody> </table> </div> |         |         |       |                 |               |                   |                    |                     |  | Name | Status | VLAN ID | Alias | IP Address | Netmask | Virtual MAC | Directed Broadcast | Source IP Overwrite | <input type="checkbox"/> LAN | Enabled | 1 | 0 | 192.168.127.254 | 255.255.255.0 | -- | Disabled | Disabled | <input checked="" type="checkbox"/> lan2 | Enabled | 3 |  | 192.168.126.1 | 255.255.255.0 | -- | Disabled | Disabled |
| Name  | Status  | VLAN ID | Alias | IP Address      | Netmask       | Virtual MAC       | Directed Broadcast | Source IP Overwrite |  |      |        |         |       |            |         |             |                    |                     |                              |         |   |   |                 |               |    |          |          |  |         |   |  |               |               |    |          |          |
| <input type="checkbox"/> LAN  | Enabled | 1       | 0     | 192.168.127.254 | 255.255.255.0 | --                | Disabled           | Disabled            |  |      |        |         |       |            |         |             |                    |                     |                              |         |   |   |                 |               |    |          |          |  |         |   |  |               |               |    |          |          |
| <input checked="" type="checkbox"/> lan2  | Enabled | 3       |       | 192.168.126.1   | 255.255.255.0 | --                | Disabled           | Disabled            |  |      |        |         |       |            |         |             |                    |                     |                              |         |   |   |                 |               |    |          |          |  |         |   |  |               |               |    |          |          |
| Max. 16   |         |         |       |                 |               |                   |                    |                     |  |      |        |         |       |            |         |             |                    |                     |                              |         |   |   |                 |               |    |          |          |  |         |   |  |               |               |    |          |          |

## WAN/WAN1

### Menu Path: Network Configuration > Network Interfaces - WAN/WAN1

This page lets you configure the settings for the WAN interfaces of your device. WAN interfaces are VLAN-based; when WAN is enabled for a VLAN ID, all ports associated with that VLAN ID will act as a single WAN interface.

#### Note

This tab may appear as WAN or WAN1 depending on your product model.

There are multiple types of WAN you can select for your **Connection Type**:

- Static IP
- Dynamic IP
- PPPoE

### Static IP

If you select **Static IP** as your **Connection Type**, these settings will appear.

### Network Interfaces

LAN
WAN
Bridge
MTU Configuration
Secondary IP

**VLAN ID**

VLAN ID  
2

**Connection**

Status: Enabled  
Connection Type: Static IP

**Directed Broadcast**

Status: Disabled

Source IP Overwrite: Disabled

**Address Information**

IP Address: 10.123.13.33    Netmask\*: 23 (255.255.254.0)    Gateway: 10.123.12.1

**PPTP Dialup**

Status: Disabled

IP Address: 0.0.0.0    Username:    Password:    0 / 30    0 / 30

MPPE Encryption: None

**Virtual MAC**

Virtual MAC: 00:00:00:00:00:00

**DNS Settings**

Primary DNS Server: 0.0.0.0    Secondary DNS Server: 0.0.0.0    Tertiary DNS Server: 0.0.0.0

APPLY

## VLAN ID

| UI Setting     | Description                                    | Valid Range | Default Value |
|----------------|--|-------------|---------------|
| <b>VLAN ID</b> | Select a VLAN ID to use for the WAN interface. | VLAN ID     | N/A           |

## Connection

| UI Setting             | Description  | Valid Range                    | Default Value |
|------------------------|--|--------------------------------|---------------|
| <b>Status</b>          | Enable or disable the WAN interface.                   | Enabled / Disabled             | Enabled       |
| <b>Connection Type</b> | Specify the connection type to use for the connection. | Static IP / Dynamic IP / PPPoE | Dynamic IP    |

## Directed Broadcast

| UI Setting                 | Description  | Valid Range        | Default Value |
|----------------------------|--|--------------------|---------------|
| <b>Status</b>              | Enable or disable directed broadcast for the interface.  | Enabled / Disabled | Disabled      |
| <b>Source IP Overwrite</b> | Enable or disable source IP overwrite for the interface. | Enabled / Disabled | Disabled      |

## Address Information

| UI Setting        | Description                                    | Valid Range       | Default Value |
|-------------------|--|-------------------|---------------|
| <b>IP Address</b> | Specify the IP address for the interface.      | Valid IP address  | 0.0.0.0       |
| <b>Netmask</b>    | Specify the subnet mask for the interface.     | Valid subnet mask | N/A           |
| <b>Gateway</b>    | Specify the gateway address for the interface. | Valid IP address  | 0.0.0.0       |

## PPTP Dialup

| UI Setting             | Description   | Valid Range        | Default Value |
|------------------------|---|--------------------|---------------|
| <b>Status</b>          | Enable or disable PPTP connection for the interface.          | Enabled / Disabled | Disabled      |
| <b>IP Address</b>      | Specify the PPTP service IP address.                          | Valid IP address   | 0.0.0.0       |
| <b>User Name</b>       | Enter the username to use for dialing in to the PPTP service. | 1 to 30 characters | N/A           |
| <b>Password</b>        | Enter the password to use for dialing in to the PPTP service. | 1 to 30 characters | N/A           |
| <b>MPPE Encryption</b> | Enable or disable MPPE encryption.                            | None / Encrypt     | None          |

## Virtual MAC

| UI Setting         | Description  | Valid Range       | Default Value     |
|--------------------|--|-------------------|-------------------|
| <b>Virtual MAC</b> | Specify the virtual MAC address for the interface. | Valid MAC address | 00.00.00.00.00.00 |

## DNS Settings

| UI Setting                  | Description                           | Valid Range | Default Value |
|-----------------------------|---------------------------------------|-------------|---------------|
| <b>Primary DNS Server</b>   | Specify the primary DNS IP address.   | IP Address  | 0.0.0.0       |
| <b>Secondary DNS Server</b> | Specify the secondary DNS IP address. | IP Address  | 0.0.0.0       |
| <b>Tertiary DNS Server</b>  | Specify the tertiary DNS IP address.  | IP Address  | 0.0.0.0       |

## Dynamic IP

If you select **Dynamic IP** as your **Connection Type**, these settings will appear.

 **Note**

Please note that settings and available options will vary depending on the product model.

### Network Interfaces

LAN
WAN
Bridge
MTU Configuration
Secondary IP

**VLAN ID**

VLAN ID  
3

**Connection**

Status  
Enabled

Connection Type  
Dynamic IP

**Directed Broadcast**

Status  
Disabled

Source IP Overwrite  
Disabled

**PPTP Dialup**

Status  
Disabled

IP Address  
0.0.0.0

Username  
0 / 30

Password  
0 / 30

MPPPE Encryption  
None

**DHCP Client Option 66/67**

Status  
Disabled

**Virtual MAC**

Virtual MAC  
00:00:00:00:00:00

**DNS Settings**

Primary DNS Server  
0.0.0.0

Secondary DNS Server  
0.0.0.0

Tertiary DNS Server  
0.0.0.0

APPLY

## VLAN ID

| UI Setting     | Description                                    | Valid Range | Default Value |
|----------------|--|-------------|---------------|
| <b>VLAN ID</b> | Select a VLAN ID to use for the WAN interface. | VLAN ID     | N/A           |

## Connection

| UI Setting             | Description  | Valid Range                    | Default Value |
|------------------------|--|--------------------------------|---------------|
| <b>Status</b>          | Enable or disable the WAN interface.                   | Enabled / Disabled             | Enabled       |
| <b>Connection Type</b> | Specify the connection type to use for the connection. | Static IP / Dynamic IP / PPPoE | Dynamic IP    |



## Directed Broadcast

| UI Setting                 | Description  | Valid Range        | Default Value |
|----------------------------|--|--------------------|---------------|
| <b>Status</b>              | Enable or disable directed broadcast for the interface.  | Enabled / Disabled | Disabled      |
| <b>Source IP Overwrite</b> | Enable or disable source IP overwrite for the interface. | Enabled / Disabled | Disabled      |

## PPTP Dialup

| UI Setting             | Description   | Valid Range        | Default Value |
|------------------------|---|--------------------|---------------|
| <b>Status</b>          | Enable or disable PPTP connection for the interface.          | Enabled / Disabled | Disabled      |
| <b>IP Address</b>      | Specify the PPTP service IP address.                          | Valid IP address   | 0.0.0.0       |
| <b>User Name</b>       | Enter the username to use for dialing in to the PPTP service. | 1 to 30 characters | N/A           |
| <b>Password</b>        | Enter the password to use for dialing in to the PPTP service. | 1 to 30 characters | N/A           |
| <b>MPPE Encryption</b> | Enable or disable MPPE encryption.                            | None / Encrypt     | None          |

## DHCP Client Option 66/67

| UI Setting    | Description                                 | Valid Range      | Default Value |
|---------------|---|------------------|---------------|
| <b>Status</b> | Enable or disable DHCP client option 66/67. | Enabled/Disabled | Disabled      |

## Virtual MAC

| UI Setting         | Description  | Valid Range       | Default Value     |
|--------------------|--|-------------------|-------------------|
| <b>Virtual MAC</b> | Specify the virtual MAC address for the interface. | Valid MAC address | 00.00.00.00.00.00 |

## DNS Settings

### Note

When using Dynamic IP, you can manually configure DNS servers here. Manually configured DNS servers will have a higher priority than DNS servers coming from the DHCP server.

| UI Setting                  | Description                           | Valid Range | Default Value |
|-----------------------------|---------------------------------------|-------------|---------------|
| <b>Primary DNS Server</b>   | Specify the primary DNS IP address.   | IP Address  | 0.0.0.0       |
| <b>Secondary DNS Server</b> | Specify the secondary DNS IP address. | IP Address  | 0.0.0.0       |
| <b>Tertiary DNS Server</b>  | Specify the tertiary DNS IP address.  | IP Address  | 0.0.0.0       |

## PPPoE

If you select **PPPoE** as your **Connection Type**, these settings will appear.

### Network Interfaces

LAN   **WAN**   Bridge   MTU Configuration   Secondary IP

VLAN ID  
VLAN ID  
2

Connection  
Status: Enabled  
Connection Type: PPPoE

Directed Broadcast  
Enabled  
Disabled

Source IP Overwrite  
Disabled

PPPoE Dialup  
Username \*   Password \*   Host Name  
0 / 30   0 / 30   0 / 30

Virtual MAC  
Virtual MAC  
00:00:00:00:00:00

DNS Settings  
Primary DNS Server: 0.0.0.0   Secondary DNS Server: 0.0.0.0   Tertiary DNS Server: 0.0.0.0

**APPLY**

## VLAN ID

| UI Setting     | Description                                    | Valid Range | Default Value |
|----------------|--|-------------|---------------|
| <b>VLAN ID</b> | Select a VLAN ID to use for the WAN interface. | VLAN ID     | N/A           |

## Connection

| UI Setting             | Description  | Valid Range                    | Default Value |
|------------------------|--|--------------------------------|---------------|
| <b>Status</b>          | Enable or disable the WAN interface.                   | Enabled / Disabled             | Enabled       |
| <b>Connection Type</b> | Specify the connection type to use for the connection. | Static IP / Dynamic IP / PPPoE | Dynamic IP    |

## Directed Broadcast

| UI Setting                 | Description  | Valid Range        | Default Value |
|----------------------------|--|--------------------|---------------|
| <b>Status</b>              | Enable or disable directed broadcast for the interface.  | Enabled / Disabled | Disabled      |
| <b>Source IP Overwrite</b> | Enable or disable source IP overwrite for the interface. | Enabled / Disabled | Disabled      |

## PPPoE Dialup

| UI Setting       | Description  | Valid Range        | Default Value |
|------------------|--|--------------------|---------------|
| <b>User Name</b> | Specify the username used to connect to the PPPoE service. | 1 to 30 characters | N/A           |
| <b>Password</b>  | Specify the password used to connect to the PPPoE service. | 1 to 30 characters | N/A           |
| <b>Host Name</b> | Specify the hostname of the PPPoE server.                  | 1 to 30 characters | N/A           |

## Virtual MAC

| UI Setting         | Description  | Valid Range       | Default Value     |
|--------------------|--|-------------------|-------------------|
| <b>Virtual MAC</b> | Specify the virtual MAC address for the interface. | Valid MAC address | 00.00.00.00.00.00 |

## DNS Settings

### Note

When using PPPoE, you can manually configure DNS servers here. Manually configured DNS servers will have a higher priority than DNS servers coming from the PPPoE server.

| UI Setting                  | Description                           | Valid Range | Default Value |
|-----------------------------|---------------------------------------|-------------|---------------|
| <b>Primary DNS Server</b>   | Specify the primary DNS IP address.   | IP Address  | 0.0.0.0       |
| <b>Secondary DNS Server</b> | Specify the secondary DNS IP address. | IP Address  | 0.0.0.0       |
| <b>Tertiary DNS Server</b>  | Specify the tertiary DNS IP address.  | IP Address  | 0.0.0.0       |

## WAN2/DMZ

### Menu Path: [Network Configuration](#) > [Network Interfaces - WAN2/DMZ](#)

This page lets you configure the settings for the WAN2 or DMZ interfaces of your device. WAN interfaces are VLAN-based; when WAN is enabled for a VLAN ID, all ports associated with that VLAN ID will act as a single WAN interface.

### Note

Availability of this feature may vary depending on your product model and version.

## Static IP

If you select **WAN2** as the **Interface Type** and **Static IP** for the **Connection Type**, these settings will appear.

### Network Interfaces

LAN
  WAN1
  WAN2/DMZ
  Bridge
  MTU Configuration
  Secondary IP

Interface Type

WAN2
  DMZ

**Connection**

Status: Enabled

Connection Type: Static IP

Proxy ARP: Disabled

**Address Information**

IP Address: 0.0.0.0

Netmask \*:

Gateway: 0.0.0.0  !

**PPTP Dialup**

Status: Disabled

IP Address: 0.0.0.0

Username:  0 / 30

Password:  0 / 30

MPPE Encryption: None

**DNS Settings**

Primary DNS Server: 0.0.0.0

Secondary DNS Server: 0.0.0.0

Tertiary DNS Server: 0.0.0.0

**APPLY**

## Connection

| UI Setting             | Description  | Valid Range                    | Default Value |
|------------------------|--|--------------------------------|---------------|
| <b>Status</b>          | Enable or disable the WAN interface.                   | Enabled / Disabled             | Enabled       |
| <b>Connection Type</b> | Specify the connection type to use for the connection. | Static IP / Dynamic IP / PPPoE | Dynamic IP    |
| <b>Proxy ARP</b>       | Enable or disable the Proxy ARP.                       | Enabled / Disabled             | Disabled      |

## Address Information

| UI Setting        | Description                                    | Valid Range       | Default Value |
|-------------------|--|-------------------|---------------|
| <b>IP Address</b> | Specify the IP address for the interface.      | Valid IP address  | 0.0.0.0       |
| <b>Netmask</b>    | Specify the subnet mask for the interface.     | Valid subnet mask | N/A           |
| <b>Gateway</b>    | Specify the gateway address for the interface. | Valid IP address  | 0.0.0.0       |

## PPTP Dialup

| UI Setting             | Description   | Valid Range        | Default Value |
|------------------------|---|--------------------|---------------|
| <b>Status</b>          | Enable or disable PPTP connection for the interface.          | Enabled / Disabled | Disabled      |
| <b>IP Address</b>      | Specify the PPTP service IP address.                          | Valid IP address   | 0.0.0.0       |
| <b>User Name</b>       | Enter the username to use for dialing in to the PPTP service. | 1 to 30 characters | N/A           |
| <b>Password</b>        | Enter the password to use for dialing in to the PPTP service. | 1 to 30 characters | N/A           |
| <b>MPPE Encryption</b> | Enable or disable MPPE encryption.                            | None / Encrypt     | None          |

## Virtual MAC

| UI Setting         | Description  | Valid Range       | Default Value     |
|--------------------|--|-------------------|-------------------|
| <b>Virtual MAC</b> | Specify the virtual MAC address for the interface. | Valid MAC address | 00.00.00.00.00.00 |

## DNS Settings

| UI Setting                | Description                         | Valid Range | Default Value |
|---------------------------|-------------------------------------|-------------|---------------|
| <b>Primary DNS Server</b> | Specify the primary DNS IP address. | IP Address  | 0.0.0.0       |

| UI Setting                  | Description                           | Valid Range | Default Value |
|-----------------------------|---------------------------------------|-------------|---------------|
| <b>Secondary DNS Server</b> | Specify the secondary DNS IP address. | IP Address  | 0.0.0.0       |
| <b>Tertiary DNS Server</b>  | Specify the tertiary DNS IP address.  | IP Address  | 0.0.0.0       |

## Dynamic IP

If you select **WAN2** as the **Interface Type** and **Dynamic IP** for the **Connection Type**, these settings will appear.

### Network Interfaces

LAN
WAN1
WAN2/DMZ
Bridge
MTU Configuration
Secondary IP

Interface Type

WAN2     DMZ

**Connection**

Status: Enabled ▾

Connection Type: Dynamic IP ▾

Proxy ARP: Disabled ▾

**PPTP Dialup**

Status: Disabled ▾

IP Address: 0.0.0.0

Username: \_\_\_\_\_ Password: \_\_\_\_\_

0 / 30                      0 / 30

MPPE Encryption: None ▾

**DHCP Client Option 66/67**

Status: Disabled ▾

**DNS Settings**

Primary DNS Server: 0.0.0.0

Secondary DNS Server: 0.0.0.0

Tertiary DNS Server: 0.0.0.0

APPLY

## Connection

| UI Setting             | Description  | Valid Range                    | Default Value |
|------------------------|--|--------------------------------|---------------|
| <b>Status</b>          | Enable or disable the WAN interface.                   | Enabled / Disabled             | Enabled       |
| <b>Connection Type</b> | Specify the connection type to use for the connection. | Static IP / Dynamic IP / PPPoE | Dynamic IP    |
| <b>Proxy ARP</b>       | Enable or disable the Proxy ARP.                       | Enabled / Disabled             | Disabled      |

## PPTP Dialup

| UI Setting             | Description   | Valid Range        | Default Value |
|------------------------|---|--------------------|---------------|
| <b>Status</b>          | Enable or disable PPTP connection for the interface.          | Enabled / Disabled | Disabled      |
| <b>IP Address</b>      | Specify the PPTP service IP address.                          | Valid IP address   | 0.0.0.0       |
| <b>User Name</b>       | Enter the username to use for dialing in to the PPTP service. | 1 to 30 characters | N/A           |
| <b>Password</b>        | Enter the password to use for dialing in to the PPTP service. | 1 to 30 characters | N/A           |
| <b>MPPE Encryption</b> | Enable or disable MPPE encryption.                            | None / Encrypt     | None          |

## DHCP Client Option 66/67

| UI Setting    | Description                                 | Valid Range      | Default Value |
|---------------|---|------------------|---------------|
| <b>Status</b> | Enable or disable DHCP client option 66/67. | Enabled/Disabled | Disabled      |



## DNS Settings

### Note

When using Dynamic IP, you can manually configure DNS servers here. Manually configured DNS servers will have a higher priority than DNS servers coming from the DHCP server.

| UI Setting                  | Description                           | Valid Range | Default Value |
|-----------------------------|---------------------------------------|-------------|---------------|
| <b>Primary DNS Server</b>   | Specify the primary DNS IP address.   | IP Address  | 0.0.0.0       |
| <b>Secondary DNS Server</b> | Specify the secondary DNS IP address. | IP Address  | 0.0.0.0       |
| <b>Tertiary DNS Server</b>  | Specify the tertiary DNS IP address.  | IP Address  | 0.0.0.0       |

## PPPoE

If you select **WAN2** as the **Interface Type** and **PPPoE** for the **Connection Type**, these settings will appear.

### Network Interfaces

- LAN
- WAN1
- WAN2/DMZ**
- Bridge
- MTU Configuration
- Secondary IP

Interface Type

WAN2  DMZ

Connection

Status: Enabled

Connection Type: PPPoE

Proxy ARP: Disabled

PPPoE Dialup

Username \* (0 / 30) Password \* (0 / 30) Host Name (0 / 30)

DNS Settings

Primary DNS Server: 0.0.0.0 Secondary DNS Server: 0.0.0.0 Tertiary DNS Server: 0.0.0.0

**APPLY**

## Connection

| UI Setting             | Description  | Valid Range                    | Default Value |
|------------------------|--|--------------------------------|---------------|
| <b>Status</b>          | Enable or disable the WAN interface.                   | Enabled / Disabled             | Enabled       |
| <b>Connection Type</b> | Specify the connection type to use for the connection. | Static IP / Dynamic IP / PPPoE | Dynamic IP    |
| <b>Proxy ARP</b>       | Enable or disable the Proxy ARP.                       | Enabled / Disabled             | Disabled      |

## PPPoE Dialup

| UI Setting       | Description  | Valid Range        | Default Value |
|------------------|--|--------------------|---------------|
| <b>User Name</b> | Specify the username used to connect to the PPPoE service. | 1 to 30 characters | N/A           |
| <b>Password</b>  | Specify the password used to connect to the PPPoE service. | 1 to 30 characters | N/A           |
| <b>Host Name</b> | Specify the hostname of the PPPoE server.                  | 1 to 30 characters | N/A           |

## DNS Settings

### Note

When using PPPoE, you can manually configure DNS servers here. Manually configured DNS servers will have a higher priority than DNS servers coming from the PPPoE server.

| UI Setting                  | Description                           | Valid Range | Default Value |
|-----------------------------|---------------------------------------|-------------|---------------|
| <b>Primary DNS Server</b>   | Specify the primary DNS IP address.   | IP Address  | 0.0.0.0       |
| <b>Secondary DNS Server</b> | Specify the secondary DNS IP address. | IP Address  | 0.0.0.0       |
| <b>Tertiary DNS Server</b>  | Specify the tertiary DNS IP address.  | IP Address  | 0.0.0.0       |

## DMZ

If you select **DMZ** as the **Interface Type**, these settings will appear.

### Network Interfaces

LAN
WAN1
WAN2/DMZ
Bridge
MTU Configuration
Secondary IP

Interface Type

WAN2
  DMZ

Address Information

IP Address

0.0.0.0

Netmask \*

▼

APPLY
DMZ Setup Wizard

## Address Information

| UI Setting        | Description                                | Valid Range       | Default Value |
|-------------------|--|-------------------|---------------|
| <b>IP Address</b> | Specify the IP address for the interface.  | Valid IP address  | 0.0.0.0       |
| <b>Netmask</b>    | Specify the subnet mask for the interface. | Valid subnet mask | N/A           |

## DMZ Setup Wizard

**Menu Path:** [Network Configuration](#) > [Network Interfaces - WAN2/DMZ](#)

Clicking the **DMZ Setup Wizard** button on the **Network Configuration > Network Interfaces - WAN2/DMZ** page will start a wizard to help you configure security policies for the DMZ.

### Step 1: Select Mode

Select between basic or advanced configuration mode.

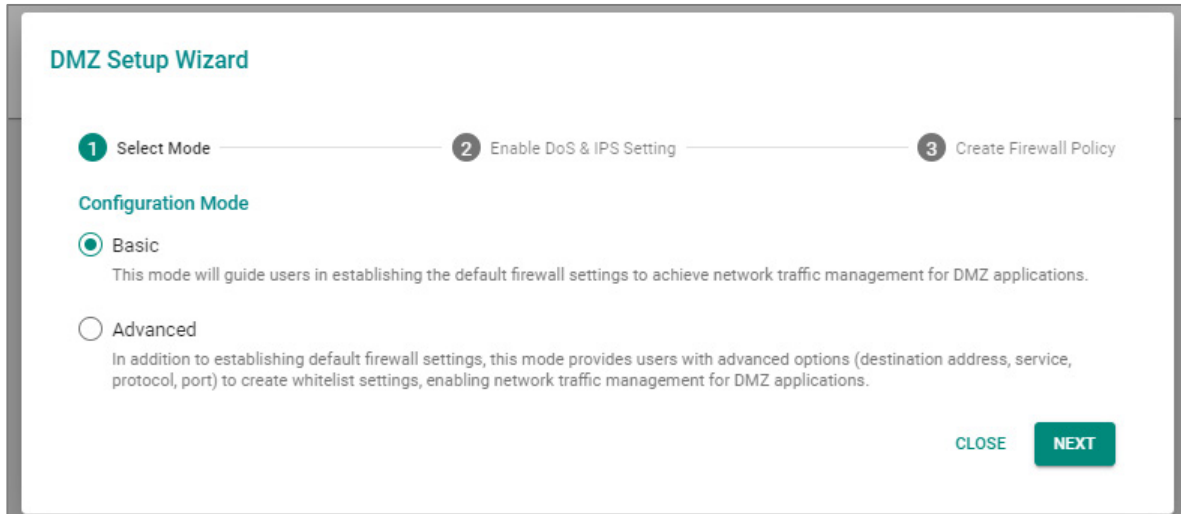

## Step 2: Enable DoS & IPS Setting

Select whether to enable DoS protection and IPS functionality.

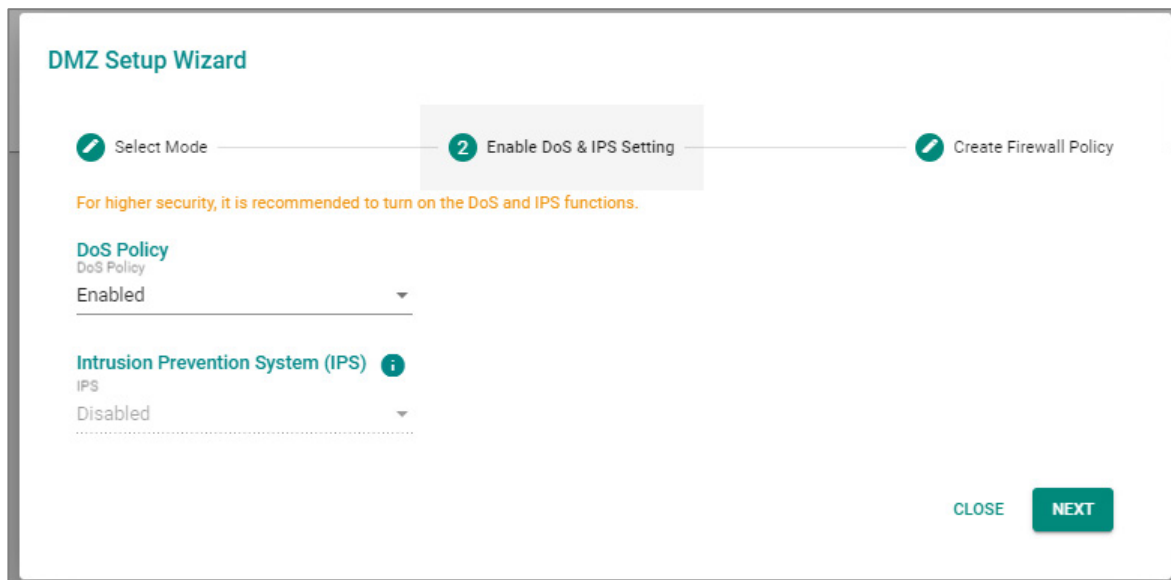

## Step 3: Create Firewall Policy

### Basic Mode

In basic mode, four policies are preconfigured for you so you don't need to set them manually.

- WAN1 to DMZ (Allow)
- DMZ to WAN1 (Allow)
- LAN to DMZ (Allow)
- DMZ to LAN (Deny)

**DMZ Setup Wizard**

1 Select Mode — 2 Enable DoS & IPS Setting — 3 Create Firewall Policy

Search

| Index ↑ | Status  | Name         | Event             | Incoming Interface | Outgoing Interface | Filter Mode           | Source Address |
|---------|---------|--------------|-------------------|--------------------|--------------------|-----------------------|----------------|
| 1       | Enabled | DMZ-FIXED-01 | Disabled /Warning | WAN1               | WAN2               | IP and Port Filtering | Any            |
| 2       | Enabled | DMZ-FIXED-02 | Disabled /Warning | WAN2               | WAN1               | IP and Port Filtering | Any            |
| 3       | Enabled | DMZ-FIXED-03 | Disabled /Warning | LAN                | WAN2               | IP and Port Filtering | Any            |
| 4       | Enabled | DMZ-FIXED-04 | Disabled /Warning | WAN2               | LAN                | IP and Port Filtering | Any            |

Max. 24      Items per page: 50      1 - 4 of 4      < >

CLOSE   APPLY

### Advanced Mode

In advanced mode, you will need to set up the correct destination address, service, protocol, and port whitelist policies according to each policy's requirements.

- WAN1 to DMZ (Deny)
- DMZ to WAN1 (Allow)
- LAN to DMZ (Deny)
- DMZ to LAN (Deny)

### DMZ Setup Wizard

1 Select Mode — 2 Enable DoS & IPS Setting — 3 Create Firewall Policy

+ Search

| Index ↑ | Status  | Name         | Event             | Incoming Interface | Outgoing Interface | Filter Mode           | Source Address |
|---------|---------|--------------|-------------------|--------------------|--------------------|-----------------------|----------------|
| 1       | Enabled | DMZ-FIXED-01 | Disabled /Warning | WAN1               | WAN2               | IP and Port Filtering | Any            |
| 2       | Enabled | DMZ-FIXED-02 | Disabled /Warning | WAN2               | WAN1               | IP and Port Filtering | Any            |
| 3       | Enabled | DMZ-FIXED-03 | Disabled /Warning | LAN                | WAN2               | IP and Port Filtering | Any            |
| 4       | Enabled | DMZ-FIXED-04 | Disabled /Warning | WAN2               | LAN                | IP and Port Filtering | Any            |

Max. 24      Items per page: 50      1 - 4 of 4      < > >> <<

CLOSE APPLY

You can also click the **Add (+)** button to add additional firewall policies.

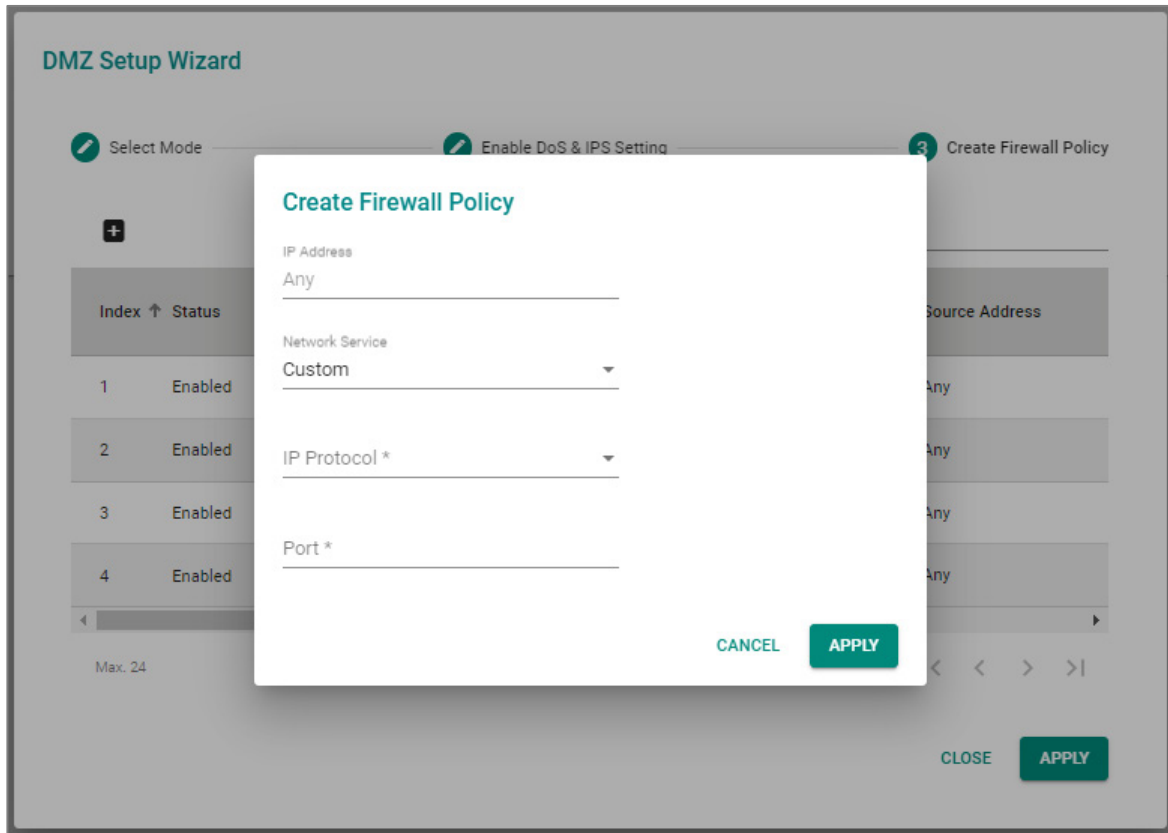

| UI Setting             | Description                  | Valid Range   | Default Value |
|------------------------|------------------------------|---|---------------|
| <b>IP Address</b>      | Specify the IP address.      | Valid IP address  | Any           |
| <b>Network Service</b> | Specify the network service. | Custom / TELNET / SSH / SMTP / FTP / HTTP / HTTPS / DNS | Custom        |
| <b>IP Protocol</b>     | Specify the IP protocol.     | TCP / UDP / TCP and UDP                                 | N/A           |
| <b>Port</b>            | Specify the port number.     | Valid port number                                       | N/A           |

To delete a firewall policy, select the checkbox next to it and click the **Delete(🗑)** button.

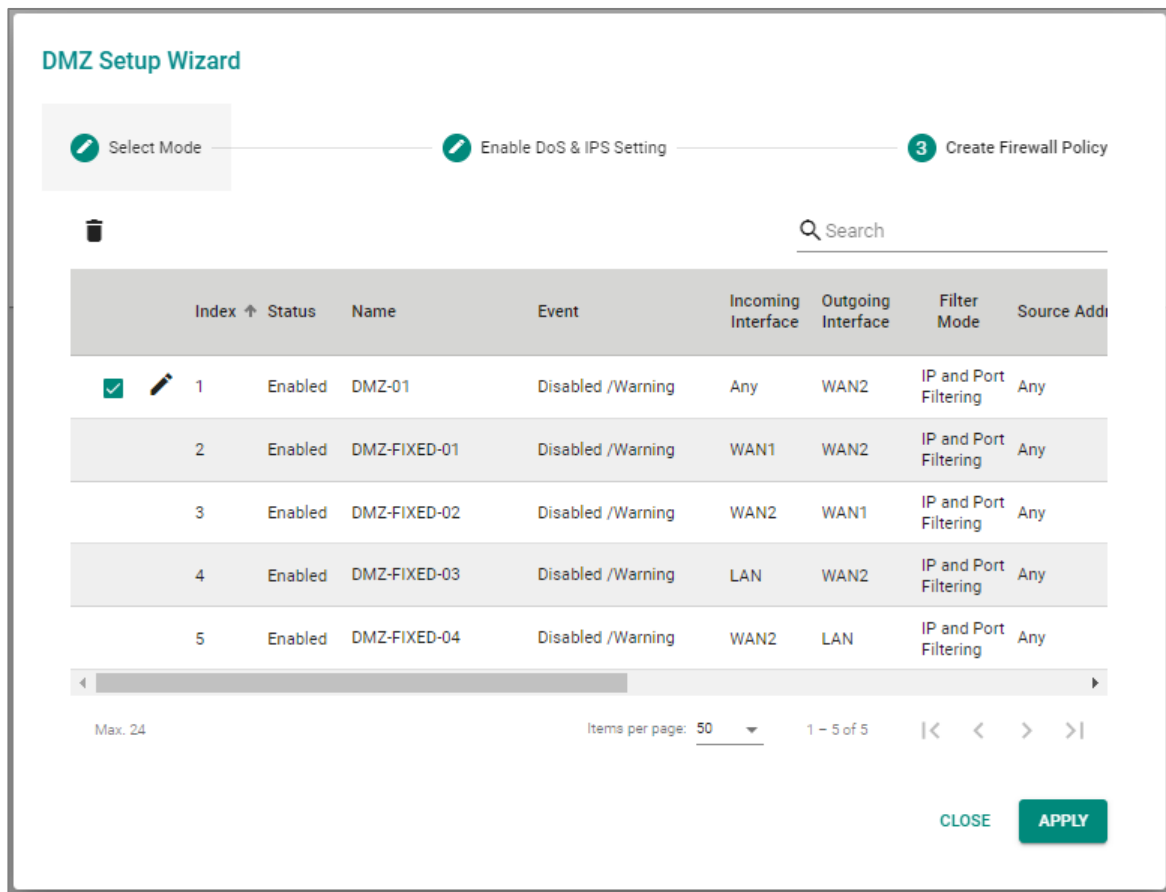

After confirming your changes, click the **APPLY** button to save your changes and finish the setup wizard.

## Bridge

**Menu Path: Network Configuration > Network Interfaces - Bridge**

This page lets you configure a bridge for your device.

You can set up these kinds of bridges:

- Port-based
- Zone-based

### Port-Based

If you select **Port-Based** as your **Bridge Type**, these settings will appear. Port-based bridges allow the device's firewall to filter traffic moving between bridge member ports.



### Bridge IP Configuration

Bridge Type

Port-Based
  Zone-Based

Name \*

BRG\_LAN

7 / 12

Status \*

Enabled ▼ i

IP Address \*      Subnet Mask \*

192.168.120.254      24 (255.255.255.0) ▼

Bridge Member ▼

APPLY

| UI Setting           | Description                                       | Valid Range             | Default Value     |
|----------------------|---|-------------------------|-------------------|
| <b>Bridge Type</b>   | Select which bridge type you want to use.         | Port-Based / Zone-Based | N/A               |
| <b>Name</b>          | Specify a name for the bridge.                    | 1 to 12 characters      | BRG_LAN           |
| <b>Status</b>        | Enable or disable the bridge.                     | Enabled / Disabled      | Disabled          |
| <b>IP Address</b>    | Specify an IP address for the bridge.             | Valid IP address        | 192.168.126.254   |
| <b>Subnet Mask</b>   | Specify a subnet mask for the bridge.             | Valid subnet mask       | 24(255.255.255.0) |
| <b>Bridge Member</b> | Select which ports will be members of the bridge. | Drop-down list of ports | N/A               |

## Zone-Based

If you select **Zone-Based** as your **Bridge Type**, these settings will appear. Zone-based bridges allow you to create zones based on VLANs. The device's firewall can filter traffic moving between different zones.

## 🔒 Limitations

You can create up to 4 different bridge zones.

### Bridge IP Configuration

Bridge Type

Port-Based  Zone-Based

Name \*  
ZONE\_BRG  
8 / 12

Status \*  
Disabled ⓘ

IP Address \*  
0.0.0.0

Subnet Mask \*  
0 (0.0.0.0) ▼

#### Zone 1

Name 0 / 12 Bridge Member ▼

#### Zone 2

Name 0 / 12 Bridge Member ▼

#### Zone 3

Name 0 / 12 Bridge Member ▼

#### Zone 4

Name 0 / 12 Bridge Member ▼

**APPLY**

| UI Setting         | Description                               | Valid Range             | Default Value |
|--------------------|---|-------------------------|---------------|
| <b>Bridge Type</b> | Select which bridge type you want to use. | Port-Based / Zone-Based | N/A           |
| <b>Name</b>        | Specify a name for the bridge.            | 1 to 12 characters      | ZONE_BRG      |
| <b>Status</b>      | Enable or disable the bridge.             | Enabled / Disabled      | Disabled      |
| <b>IP Address</b>  | Specify an IP address for the bridge.     | Valid IP address        | 0.0.0.0       |
| <b>Subnet Mask</b> | Specify a subnet mask for the bridge.     | Valid subnet mask       | 0 (0.0.0.0)   |

Each zone has the following settings:

| UI Setting           | Description  | Valid Range             | Default Value |
|----------------------|--|-------------------------|---------------|
| <b>Name</b>          | Specify a name for the bridge zone.                        | 1 to 12 characters      | N/A           |
| <b>Bridge Member</b> | Select which VLAN will determine the members of this zone. | Drop-down list of VLANs | N/A           |

## MTU Configuration

**Menu Path: Network Configuration > Network Interfaces - MTU**

This page lets you configure the MTU settings for your interfaces.

| Network Interfaces |      |             |                   |              |
|--------------------|------|-------------|-------------------|--------------|
| LAN                | WAN  | Bridge      | MTU Configuration | Secondary IP |
|                    |      |             |                   |              |
| Name               | MTU  | PRP Traffic |                   |              |
| WAN                | 1500 | --          |                   |              |
| LAN                | 1500 | --          |                   |              |
| lan2               | 1500 | --          |                   |              |
| Max: 16            |      |             |                   |              |

| UI Setting  | Description                                |
|-------------|--|
| <b>Name</b> | Shows the name of the interface.           |
| <b>MTU</b>  | Shows the MTU size used for the interface. |

| UI Setting         | Description                                     |
|--------------------|---|
| <b>PRP Traffic</b> | Shows the PRP traffic status for the interface. |

## MTU Configuration - Edit MTU Entry

### Menu Path: Network Configuration > Network Interfaces - MTU Configuration

Clicking the **Edit** (✎) icon for an interface on the **Network Configuration > Network Interfaces - MTU Configuration** page will open this dialog box. This dialog lets you edit the MTU settings for an interface. Click **APPLY** to save your changes.

| UI Setting   | Description   | Valid Range | Default Value     |
|--|---|-------------|-------------------|
| <b>Name</b>  | Shows the name of of this interface. This setting cannot be changed here. | N/A         | Name of interface |
| <b>MTU</b>   | Specify the MTU size to use for the interface.                            | 68 to 1578  | 1500              |
| <p> <b>Note</b><br/>Jumbo Frames are not currently supported.</p> |   |             |                   |

## Secondary IP

### Menu Path: Network Configuration > Network Interfaces - Secondary IP

This page lets you create secondary IPs for your interfaces. The Layer 3 interface can act as a secondary IP for a network interface, allowing a single interface to communicate with multiple networks, increasing network flexibility and availability.

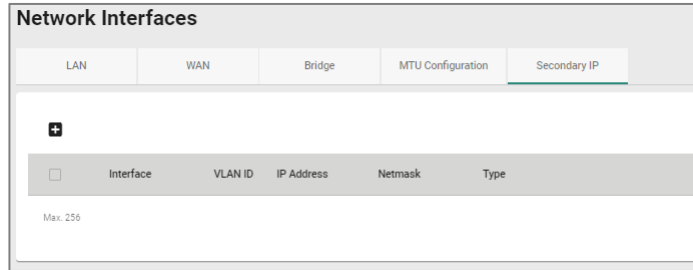

| UI Setting        | Description                                       |
|-------------------|---|
| <b>Interface</b>  | Shows which interface the secondary IP is for.    |
| <b>VLAN ID</b>    | Shows the VLAN ID used for the interface.         |
| <b>IP Address</b> | Shows the secondary IP address for the interface. |
| <b>Netmask</b>    | Shows the subnet mask of the secondary IP.        |
| <b>Type</b>       | Shows the type of the secondary IP.               |

## Secondary IP - Edit Secondary IP Entry

### Menu Path: Network Configuration > Network Interfaces - Secondary IP

Clicking the **Edit** (✎) icon on the **Network Configuration > Network Interfaces - Secondary IP** page will open this dialog box. This dialog lets you edit an existing secondary IP entry. Click **SAVE** to save your changes.

| UI Setting        | Description  | Valid Range                  | Default Value |
|-------------------|--|------------------------------|---------------|
| <b>Interface</b>  | Select which interface the secondary IP is for.    | Drop-down list of interfaces | N/A           |
| <b>IP Address</b> | Specify the IP address of the secondary interface. | Valid IP address             | N/A           |

| UI Setting     | Description   | Valid Range   | Default Value |
|----------------|---|---------------|---------------|
| <b>Netmask</b> | Specify the subnet mask of the secondary interface. | Valid netmask | N/A           |

## Secondary IP - Create Secondary IP Entry

### Menu Path: Network Configuration > Network Interfaces - Secondary IP

Clicking the **Add (+)** icon on the **Network Configuration > Network Interfaces - Secondary IP** page will open this dialog box. This dialog lets you create a secondary IP for an interface. Click **CREATE** to save your changes and add the new secondary IP.

#### **Limitations**

You can create up to 640 secondary IPs.

| UI Setting        | Description   | Valid Range                  | Default Value |
|-------------------|---|------------------------------|---------------|
| <b>Interface</b>  | Select which interface the secondary IP is for.     | Drop-down list of interfaces | N/A           |
| <b>IP Address</b> | Specify the IP address of the secondary interface.  | Valid IP address             | N/A           |
| <b>Netmask</b>    | Specify the subnet mask of the secondary interface. | Valid netmask                | N/A           |

## Delete Secondary IP

### Menu Path: Network Configuration > Network Interfaces - Secondary IP

You can delete secondary IP entries by using the checkboxes to select the entries you want to delete, then clicking the **Delete (🗑)** icon.

| <input checked="" type="checkbox"/> | Interface | VLAN ID | IP Address      | Netmask       | Type   |
|-------------------------------------|-----------|---------|-----------------|---------------|--------|
| <input checked="" type="checkbox"/> | LAN       | 1       | 192.168.100.100 | 255.255.255.0 | Manual |

Max. 640

Items per page: 50 1 - 1 of 1

## Virtual Interface

**Menu Path: Network Configuration > Network Interfaces - Virtual Interface**

This page lets you create virtual interfaces for your device.

## Loopback Interface List

**Network Interfaces**

LAN WAN Bridge MTU Configuration Secondary IP Virtual Interface

Loopback Interface

| <input checked="" type="checkbox"/> | Name | Status   | ID | IP Address  | Netmask         |
|-------------------------------------|------|----------|----|-------------|-----------------|
| <input checked="" type="checkbox"/> | test | Disabled | 1  | 192.168.1.1 | 255.255.255.254 |

Max. 10

Items per page: 50 1 - 1 of 1

| UI Setting        | Description  |
|-------------------|--|
| <b>Name</b>       | Shows the name of the loopback interface.                    |
| <b>Status</b>     | Shows whether the loopback interface is enabled or disabled. |
| <b>ID</b>         | Specify the ID of the loopback interface.                    |
| <b>IP Address</b> | Specify the IP address of the loopback interface.            |
| <b>Netmask</b>    | Specify the subnet mask of the loopback interface.           |

## Delete Loopback Interface

### Menu Path: Network Configuration > Network Interfaces - Virtual Interface

You can delete an interface by using the checkboxes to select the interfaces you want to delete, then clicking the **Delete (🗑)** icon.

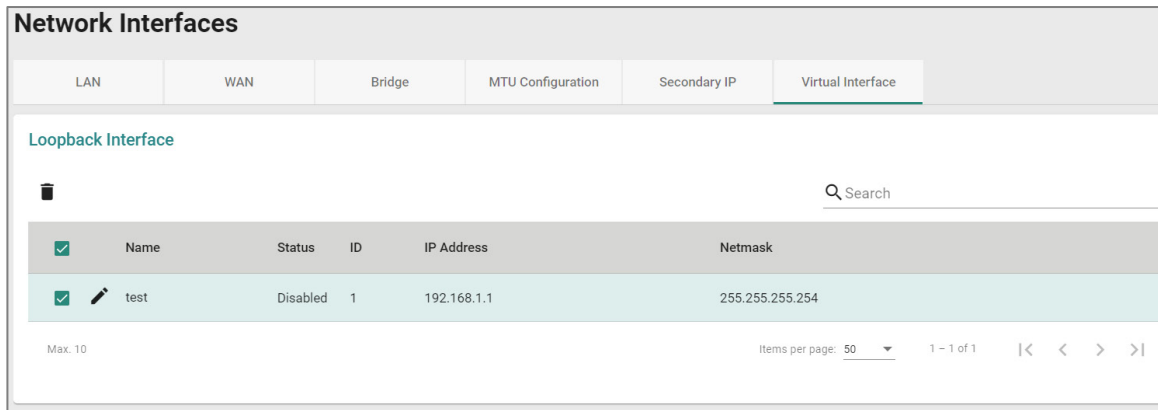

## Create Loopback Interface Entry

### Menu Path: Network Configuration > Network Interfaces - Virtual Interface

Clicking the **Add (+)** icon on the **Network Configuration > Network Interfaces - Virtual Interface** page will open this dialog box. This dialog lets you create a loopback interface.

Click **CREATE** to save your changes and add the new interface.

The dialog box is titled 'Create Loopback Interface Entry'. It contains the following fields:

- Name \*: Text input field with a character count of 0 / 12.
- Status \*: Dropdown menu.
- ID \*: Text input field with a character count of 1 - 64 and an information icon.
- IP Address \*: Text input field.
- Netmask \*: Dropdown menu.

At the bottom right, there are two buttons: 'CANCEL' and 'CREATE'.



| UI Setting        | Description   | Valid Range        | Default Value |
|-------------------|---|--------------------|---------------|
| <b>Name</b>       | Specify the name of the loopback interface.         | 1 to 12 characters | N/A           |
| <b>Status</b>     | Enable or disable the loopback interface.           | Enabled / Disabled | N/A           |
| <b>ID</b>         | Specify the ID for the loopback interface.          | 1 to 64            | N/A           |
| <b>IP Address</b> | Specify the IP address of the secondary interface.  | Valid IP address   | N/A           |
| <b>Netmask</b>    | Specify the subnet mask of the secondary interface. | Valid subnet mask  | N/A           |

# Redundancy

## Menu Path: Redundancy

The Redundancy settings area lets you configure redundancy settings to help you ensure network availability.

This settings area includes these sections:

- Layer 2 Redundancy
- Layer 3 Redundancy
- WAN Redundancy

## Redundancy - User Privileges

Privileges to Redundancy settings are granted to the different authority levels as follows. Refer to [System > Account Management > User Accounts](#) for more information on user accounts.

| Settings                  | Admin | Supervisor | User |
|---------------------------|-------|------------|------|
| <b>Layer 2 Redundancy</b> |       |            |      |
| <b>Spanning Tree</b>      | R/W   | R/W        | R    |
| <b>Turbo Ring V2</b>      | R/W   | R/W        | R    |
| <b>Turbo Chain</b>        | R/W   | R/W        | R    |
| <b>Layer 3 Redundancy</b> |       |            |      |
| <b>VRRP</b>               | R/W   | R/W        | R    |
| <b>WAN Redundancy</b>     | R/W   | R/W        | R    |

## Layer 2 Redundancy

### Menu Path: Redundancy > Layer 2 Redundancy

This section lets you manage various Layer 2 redundancy features for your device.

This section includes these pages:

- [Spanning Tree](#)
- [Turbo Ring V2](#)
- [Turbo Chain](#)

## Spanning Tree

**Menu Path:** [Redundancy](#) > [Layer 2 Redundancy](#) > [Spanning Tree](#)

This page lets you configure Spanning Tree Protocol (STP) settings for redundancy.

This page includes these tabs:

- [General](#)
- [Status](#)

### Spanning Tree - General

**Menu Path:** [Redundancy](#) > [Layer 2 Redundancy](#) > [Spanning Tree - General](#)

This page lets you configure spanning tree settings for your device.

## Spanning Tree Settings

### Spanning Tree

General

Status

Status \*  
Enabled 1

Bridge Priority \*  
32768

Forward Delay Time \*  
15 4-30 sec.

Hello Time \*  
2 1-2 sec.

Max Age \*  
20 6-40 sec.

APPLY

| Port | Status   | Edge  | Priority | Path Cost |
|------|----------|-------|----------|-----------|
| 3    | Disabled | False | 128      | 20000     |
| 4    | Disabled | False | 128      | 20000     |
| 5    | Disabled | False | 128      | 20000     |
| 6    | Disabled | False | 128      | 20000     |
| 8    | Disabled | False | 128      | 20000     |
| G1   | Disabled | False | 128      | 20000     |
| G2   | Disabled | False | 128      | 20000     |

1 - 7 of 7

| UI Setting                | Description   | Valid Range                      | Default Value |
|---------------------------|---|----------------------------------|---------------|
| <b>Status</b>             | Enable or disable Spanning Tree Protocol for the device.  | Enabled / Disabled               | Enabled       |
| <b>Bridge Priority</b>    | Specify the bridge priority. Lower numbers represent higher priority. A device with a higher bridge priority has a greater chance of being established as the root of the spanning tree topology.   | 0 to 61440, in multiples of 4096 | 32768         |
| <b>Forward Delay Time</b> | Specify the forwarding delay time. This is the amount of time this device will wait before checking to see if it should change to a different state.  | 4 to 30 seconds                  | 15            |
| <b>Hello Time</b>         | Specify the interval at which the device, if it is currently the root of the spanning tree topology, will send out periodic "Hello" messages to other devices on the network to check if the topology is healthy.   | 1 to 2 seconds                   | 2             |
| <b>Max Age</b>            | Specify the maximum age duration to wait for a "Hello" message from the root of the spanning tree topology before the device will reconfigure itself as root. If two or more devices on the network are recognized as a root, the devices will negotiate to determine which will act as the new root. | 6 to 40 seconds                  | 20            |

## Spanning Tree List

### Note

We recommend that you disable Spanning Tree Protocol on a port if it is connected to a device (such as a PLC or RTU) instead of network equipment, as this may cause unnecessary negotiation.







### Spanning Tree

General    Status

Status \*  
Enabled 

Bridge Priority \*    Forward Delay Time \*    Hello Time \*    Max Age \*  
32768    15    2    20  
4 - 30 sec.    1 - 2 sec.    6 - 40 sec.

**APPLY**

| Port   | Status   | Edge  | Priority | Path Cost |
|--|----------|-------|----------|-----------|
|  3    | Disabled | False | 128      | 20000     |
|  4    | Disabled | False | 128      | 20000     |
|  5  | Disabled | False | 128      | 20000     |
|  6  | Disabled | False | 128      | 20000     |
|  8  | Disabled | False | 128      | 20000     |
|  G1 | Disabled | False | 128      | 20000     |
|  G2 | Disabled | False | 128      | 20000     |

1 - 7 of 7

### UI Setting

### Description

**Port** Shows the port number.

**Status** Shows the status of the port as a node in the spanning tree topology.

**Edge** Shows whether the port is an edge port or not.

**Force Edge:** The port is fixed as an edge port and will always be in the forwarding state.

**False:** The port is not an edge port.

**Priority** Shows the priority of the port. Lower numbers indicate higher priority.

**Path Cost** Shows the path cost for the port. Higher path costs indicate that this port is less suitable as a node for the spanning tree topology.

If set to 0, the path cost will be automatically calculated based on different port speeds.

## Spanning Tree - Edit Port Settings

**Menu Path:** Redundancy > Layer 2 Redundancy > Spanning Tree - General

Clicking the **Edit** (✎) icon for an port on the **Redundancy > Layer 2 Redundancy > Spanning Tree - General** page will open this dialog box. This dialog lets you configure the spanning tree settings for a port. Click **APPLY** to save your changes.

**Edit Port 1/2 Settings**

Status \*  
Disabled

Edge \*  
False

Priority \*  
128

Path Cost \*  
20000  
1 - 200000000

CANCEL APPLY

| UI Setting       | Description   | Valid Range                  | Default Value |
|------------------|---|------------------------------|---------------|
| <b>Status</b>    | Enable or disable the port as a node in the spanning tree topology.   | Enabled / Disabled           | Disabled      |
| <b>Edge</b>      | Specify whether the port is an edge port or not.<br><br><b>Force Edge:</b> The port is fixed as an edge port and will always be in the forwarding state.<br><br><b>False:</b> The port is not an edge port.                                 | Force Edge / False           | False         |
| <b>Priority</b>  | Specify the priority of the port. Lower numbers indicate higher priority.   | 0 to 240, in multiples of 16 | 128           |
| <b>Path Cost</b> | Specify the path cost for the port. Higher path costs indicate that this port is less suitable as a node for the spanning tree topology.<br><br>If set to 0, the path cost will be automatically calculated based on different port speeds. | 1 to 200000000               | 20000         |

**Note**

The default value may vary depending on the maximum speed supported by the port.

## Spanning Tree - Status

**Menu Path:** Redundancy > Layer 2 Redundancy > Spanning Tree - Status

This page lets you see the current spanning tree status of your device and its ports.

## Root Information

### Spanning Tree

General **Status**

**Root Information** ↻

Root State  
---

↻

| Port | Status   | Edge  | Priority | Path Cost | Port State |
|------|----------|-------|----------|-----------|------------|
| 3    | Disabled | False | 128      | 20000     | ---        |
| 4    | Disabled | False | 128      | 20000     | ---        |
| 5    | Disabled | False | 128      | 20000     | ---        |
| 6    | Disabled | False | 128      | 20000     | ---        |
| 8    | Disabled | False | 128      | 20000     | ---        |
| G1   | Disabled | False | 128      | 20000     | ---        |
| G2   | Disabled | False | 128      | 20000     | ---        |

1 - 7 of 7

| UI Setting | Description |
|------------|-------------|
|------------|-------------|

|                   |   |
|-------------------|---|
| <b>Root State</b> | Shows whether the device is currently acting as the root of the spanning tree topology. |
|-------------------|---|

## Spanning Tree Port List

### Spanning Tree

General **Status**

**Root Information** ↻

Root State  
---

↻

| Port | Status   | Edge  | Priority | Path Cost | Port State |
|------|----------|-------|----------|-----------|------------|
| 3    | Disabled | False | 128      | 20000     | ---        |
| 4    | Disabled | False | 128      | 20000     | ---        |
| 5    | Disabled | False | 128      | 20000     | ---        |
| 6    | Disabled | False | 128      | 20000     | ---        |
| 8    | Disabled | False | 128      | 20000     | ---        |
| G1   | Disabled | False | 128      | 20000     | ---        |
| G2   | Disabled | False | 128      | 20000     | ---        |

1 - 7 of 7

| UI Setting        | Description   |
|-------------------|---|
| <b>Port</b>       | Shows the port number.  |
| <b>Enable</b>     | Shows whether Spanning Tree Protocol is enabled for the port.   |
| <b>Edge</b>       | Shows whether the port is an edge port or not.<br><b>Force Edge:</b> The port is fixed as an edge port and will always be in the forwarding state.<br><b>True:</b> The port is currently designated as an edge port.<br><b>False:</b> The port is not an edge port. |
| <b>Priority</b>   | Shows the priority of the port. Lower numbers indicate higher priority.   |
| <b>Path Cost</b>  | Shows the path cost for the port. Higher path costs indicate that this port is less suitable as a node for the spanning tree topology.<br>If set to 0, the path cost will be automatically calculated based on different port speeds.                               |
| <b>Port State</b> | Shows the current spanning tree status of the port.<br><b>Forwarding:</b> Indicates the port is allowing transmissions normally.<br><b>Blocking:</b> Indicates the port is blocking transmissions.  |

## Turbo Ring V2

**Menu Path:** [Redundancy](#) > [Layer 2 Redundancy](#) > [Turbo Ring V2](#)

This page lets you manage the Turbo Ring V2 redundancy feature for your device.

This page includes these tabs:

- General
- Status

### Turbo Ring V2 - General

**Menu Path:** [Redundancy](#) > [Layer 2 Redundancy](#) > [Turbo Ring V2 - General](#)

This page lets you configure the Turbo Ring settings for your device.



## Turbo Ring Settings

**Turbo Ring V2**

General | Status

Status: Disabled

APPLY

**Ring Settings**

| Ring ID | Status   | Master  | Ring Port 1 | Ring Port 2 |
|---------|----------|---------|-------------|-------------|
| Ring 1  | Disabled | Enabled | --          | 8           |
| Ring 2  | Enabled  | Enabled | 5           | 6           |

1-2 of 2

**Ring Coupling Settings**

Status: Disabled

Coupling Mode: [Dropdown]

Coupling Port: 3

APPLY

| UI Setting    | Description                                     | Valid Range        | Default Value |
|---------------|---|--------------------|---------------|
| <b>Status</b> | Enable or disable Turbo Ring V2 for the device. | Enabled / Disabled | Disabled      |

## Ring Settings

### Note

To set up a Dual-Ring architecture, you must enable both Ring 1 and Ring 2.

**Turbo Ring V2**

General | Status

Status: Disabled

APPLY

**Ring Settings**

| Ring ID | Status   | Master  | Ring Port 1 | Ring Port 2 |
|---------|----------|---------|-------------|-------------|
| Ring 1  | Disabled | Enabled | --          | 8           |
| Ring 2  | Enabled  | Enabled | 5           | 6           |

1-2 of 2

**Ring Coupling Settings**

Status: Disabled

Coupling Mode: [Dropdown]

Coupling Port: 3

APPLY

| UI Setting         | Description   |
|--------------------|---|
| <b>Ring ID</b>     | Shows the ring ID.  |
| <b>Status</b>      | Shows the status of the ring.   |
| <b>Master</b>      | Shows whether this device is designated as the master for the ring.   |
| <b>Ring Port 1</b> | Shows which port will act as ring port 1. If this device is designated as the master for the ring, this will be the primary ring connection.                              |
| <b>Ring Port 2</b> | Shows which port will act as ring port 2. If this device is designated as the master for the ring, this will be the backup ring connection, and will be blocked normally. |

## Turbo Ring V2 - Ring Settings

**Menu Path: Redundancy > Layer 2 Redundancy > Turbo Ring V2 - General**

Clicking the **Edit (✎)** icon for a ring on the **Redundancy > Layer 2 Redundancy > Turbo Ring V2 - General** page will open this dialog box. This dialog lets you adjust your device's settings for the ring. Click **APPLY** to save your changes.

The screenshot shows a dialog box titled "Ring 1 Settings". It contains four settings, each with a dropdown menu:

- Status \*: Enabled
- Master \*: Enabled
- Ring Port 1 \*: 3
- Ring Port 2 \*: 8

At the bottom right of the dialog, there are two buttons: "CANCEL" and "APPLY".

| UI Setting         | Description  | Valid Range                           | Default Value |
|--------------------|--|---------------------------------------|---------------|
| <b>Status</b>      | Enable or disable Turbo Ring V2 for the device.  | Enabled / Disabled                    | Disabled      |
| <b>Master</b>      | Enable or disable whether this device will be designated as the master for the ring.   | Enabled / Disabled                    | Disabled      |
| <b>Ring Port 1</b> | Specify which port will act as ring port 1. If this device is designated as the master for the ring, this will be the primary ring connection. | Select a port from the drop-down menu | 7             |

| UI Setting         | Description   | Valid Range                           | Default Value |
|--------------------|---|---------------------------------------|---------------|
| <b>Ring Port 2</b> | Specify which port will act as ring port 2. If this device is designated as the master for the ring, this will be the backup ring connection, and will be blocked normally. | Select a port from the drop-down menu | 8             |

## Ring Coupling Settings

### Ring Coupling Settings

Status \*

Coupling Mode \*

Primary Port \*      Backup Port \*  
     

**APPLY**

| UI Setting  | Description  | Valid Range                              | Default Value |
|---|--|--|---------------|
| <b>Status</b>   | Enable or disable ring coupling for the device.  | Enabled / Disabled                       | Disabled      |
| <b>Coupling Mode (if Status is Enabled)</b>           | Specify the coupling mode for the device.<br><b>Dual Homing:</b> This device will handle both the primary path and backup path for ring coupling.<br><b>Backup Path:</b> This device only handles the backup path for ring coupling; the primary path will be handled by another device.<br><b>Primary Path:</b> This device only handles the primary path for ring coupling; the backup path will be handled by another device. | Dual Homing / Backup Path / Primary Path | N/A           |
| <b>Primary Port (if Coupling Mode is Dual Homing)</b> | Specify the port that connects to the primary path for ring coupling.  | Select a port from the drop-down menu    | 3             |

| UI Setting  | Description  | Valid Range                           | Default Value |
|---|--|---------------------------------------|---------------|
| <b>Backup Port</b><br>(if Coupling Mode is Dual Homing)                   | Specify the port that connects to the backup path for ring coupling.             | Select a port from the drop-down menu | N/A           |
| <b>Coupling Port</b><br>(if Coupling Mode is Primary Path or Backup Path) | Specify the port that connects to primary path or backup path for ring coupling. | Select a port from the drop-down menu | 3             |

## Turbo Ring V2 - Status

**Menu Path:** [Redundancy](#) > [Layer 2 Redundancy](#) > [Turbo Ring V2 - Status](#)

This page lets you see the current status of your rings and ring couplings.

### Ring Status

| UI Setting       | Description  |
|------------------|--|
| <b>Ring ID</b>   | Shows the ID number of the ring.   |
| <b>Master ID</b> | Shows the MAC address of the ring master.  |
| <b>Status</b>    | Shows the current status of the ring.<br><b>Healthy:</b> The ring and its related ports are working properly.<br><b>Break:</b> One or more rings are broken. |

| UI Setting         | Description   |
|--------------------|---|
| <b>Master</b>      | Shows whether this device is acting as a master or slave in the ring. |
| <b>Ring Port 1</b> | Shows which port is acting as the first ring port.                    |
| <b>Ring Port 2</b> | Shows which port is acting as the second ring port.                   |

## Ring Coupling Status

| UI Setting           | Description                                      |
|----------------------|--|
| <b>Coupling Mode</b> | Shows the mode being used for the ring coupling. |
| <b>Primary Port</b>  | Shows the primary port for the ring coupling.    |
| <b>Backup Port</b>   | Shows the backup port for the ring coupling.     |

## Turbo Chain

### Menu Path: [Redundancy](#) > [Layer 2 Redundancy](#) > [Turbo Chain](#)

This page lets you configure Turbo Chain settings for redundancy.

This page includes these tabs:

- Settings
- Status

## Turbo Chain - Settings

**Menu Path:** Redundancy > Layer 2 Redundancy > Turbo Chain - Settings

This section lets you enable and configure Turbo Chain for your device.

Status \*  
Disabled ▾

Chain Role \*  
Member ▾

Member Port 1 \*  
G1 ▾

Member Port 2 \*  
G2 ▾

**APPLY**

| UI Setting           | Description                              | Valid Range             | Default Value |
|----------------------|--|-------------------------|---------------|
| <b>Turbo Chain</b>   | Enable or disable Turbo Chain.           | Enabled / Disabled      | Disabled      |
| <b>Chain Role</b>    | Select the chain role of the device.     | Head / Member / Tail    | Member        |
| <b>Member Port 1</b> | Select which port will be Member Port 1. | Drop-down menu of ports | 1/9           |
| <b>Member Port 2</b> | Select which port will be Member Port 2. | Drop-down menu of ports | 1/10          |

## Turbo Chain - Status

**Menu Path:** Redundancy > Layer 2 Redundancy > Turbo Chain - Status

This page lets you view the current status of Turbo Chain for your device.

**Chain Information** ↻

|   |   |
|---|---|
| Status<br><b>Disabled</b>               | Chain Role<br><b>Member</b>             |
| Member 1 Port Status<br><b>Disabled</b> | Member 2 Port Status<br><b>Disabled</b> |

| UI Setting         | Description                      |
|--------------------|----------------------------------|
| <b>Turbo Chain</b> | Shows the status of Turbo Chain. |

| UI Setting                  | Description                           |
|-----------------------------|---------------------------------------|
| <b>Chain Role</b>           | Shows the chain role for your device. |
| <b>Member Port 1 Status</b> | Shows the status of Member Port 1.    |
| <b>Member Port 2 Status</b> | Shows the status of Member Port 2.    |

## Layer 3 Redundancy

### Menu Path: Redundancy > Layer 3 Redundancy

This section lets you configure the Layer 3 redundancy features of your device.

This section includes these pages:

- VRRP

## VRRP

### Menu Path: Redundancy > Layer 3 Redundancy > VRRP

This page lets you configure the VRRP settings for your device.

This page includes these tabs:

- Settings
- Status

## VRRP - Settings

### Menu Path: Redundancy > Layer 3 Redundancy > VRRP - Settings

This page lets you configure the VRRP settings for your device.

#### Note

Virtual Router Redundancy Protocol (VRRP) helps solve some problems with static configurations. VRRP enables a group of routers to form a single virtual router with a virtual IP address. The LAN clients can then be configured with the virtual router's virtual IP address as their default gateway. This virtual router consisting of a group of routers is also known as a VRRP group.

## 🔒 Limitations

You can create up to 16 virtual routers.

## VRRP Settings

| UI Setting   | Description  | Valid Range                        | Default Value |
|--|--|------------------------------------|---------------|
| <b>VRRP</b>  | Enable or disable VRRP for the device.   | Enabled / Disabled                 | Disabled      |
| <b>Version</b>   | Select the VRRP version to use.  | Version 2 / Version 3              | Version 3     |
| <b>Event</b>   | Select the event for VRRP.   | No Event / Link Status / DI Status | No Event      |
| <b>On - VRRP Priority (If Event is Link Status or DI Status)</b> | Specify the VRRP Priority when the event is On.<br><br><div style="background-color: #f0f0f0; padding: 5px;"> <p><b>Note</b></p> <p>If this is 0, the device will use the priority assigned to each VRRP interface.</p> </div> | 0 to 254                           | 0             |



| UI Setting  | Description   | Valid Range             | Default Value |
|---|---|-------------------------|---------------|
| <b>Off - VRRP Priority<br/>(If Event is Link Status or DI Status)</b> | Specify the VRRP Priority when the event is Off.<br><br><div style="border: 1px solid #ccc; background-color: #f9f9f9; padding: 5px; margin-top: 10px;"> <p><b>Note</b></p> <p>If this is 0, the device will use the priority assigned to each VRRP interface.</p> </div> | 0 to 254                | 0             |
| <b>Monitored Port<br/>(If Event is Link Status)</b>                   | Select the port to monitor.   | Drop-down list of ports | 1             |

## VRRP List

The screenshot shows the VRRP configuration page. At the top, there are tabs for 'Settings' and 'Status'. Under 'Settings', there are dropdown menus for 'VRRP' (set to 'Disabled') and 'Version' (set to 'Version 3'), with an 'APPLY' button below. Below the settings is a table with columns: Status, Index, Interface, IP Address, VIP, VRID, Prio., Adv Int(ms), Preemption, Accept, Tracking Interface, and Tracking Ping. The table is currently empty, with a search bar and 'Max 10' entries visible.

| UI Setting        | Description   |
|-------------------|---|
| <b>Status</b>     | Shows the status of the VRRP interface.   |
| <b>Index</b>      | Shows the index number used to identify the VRRP interface.   |
| <b>Interface</b>  | Shows which network interface is used for the VRRP interface.   |
| <b>IP Address</b> | Shows the IP address of the VRRP interface.   |
| <b>VIP</b>        | Shows the virtual router IP address for the VRRP interface.   |
| <b>VRID</b>       | Shows the virtual router ID for the VRRP interface, which is used to assign the virtual router to a VRRP group. |
| <b>Prio.</b>      | Shows the priority of the VRRP interface. Higher numbers indicate higher priority, with 254 being the highest.  |

| UI Setting                | Description  |
|---------------------------|--|
| <b>Adv int(ms)</b>        | Shows the advertisement interval for the VRRP interface in milliseconds.   |
| <b>Preemption</b>         | Shows the preemption status of the VRRP interface.   |
| <b>Accept</b>             | Shows whether Accept Mode is enabled for the VRRP interface. When enabled, the virtual router designated as the master will allow others to access its own virtual IP address. |
| <b>Tracking Interface</b> | Shows whether Native Interface Tracking is enabled for the VRRP interface.   |
| <b>Tracking Ping</b>      | Shows the tracking ping status of the VRRP interface.  |

## VRRP - Edit Virtual Router

### Menu Path: Redundancy > Layer 3 Redundancy > VRRP - Settings

Clicking the Edit (/) icon for a VRRP interface on the Redundancy > Layer 3 Redundancy > VRRP - Settings page will open this dialog box. This dialog lets you edit an existing virtual router. Click APPLY to save your changes.

**Edit Virtual Router**

**VRRP Interface Setting**

Status  
Disabled

Interface  
WAN

Virtual IP \* 1.1.1.1      Virtual Router ID \* 1      Priority \* 100  
1 - 255      1 - 254

Accept Mode  
Enabled

Preemption  
Enabled      Preempt Delay \* 120  
0 - 300 sec.

Advertisement Interval \* 100  
10 - 30000 msec.

**VRRP Tracking**

Native Interface Tracking  
Disabled

**Object Ping Tracking**



Target IP  
Leave empty or set to 0.0.0.0 to disable

Interval \* 1      Timeout \* 3  
1 - 100 sec.      1 - 100 sec.

Success Count \* 3      Failure Count \* 3  
1 - 100      1 - 100

CANCEL    APPLY

## VRRP Interface Setting Entry

| UI Setting                                      | Description  | Valid Range                  | Default Value |
|---|--|------------------------------|---------------|
| <b>Status</b>                                   | Enable or disable the VRRP interface.  | Enabled / Disabled           | Disabled      |
| <b>Interface</b>                                | Specify which network interface to use for the VRRP interface.   | Drop-down list of interfaces |               |
| <b>Virtual IP</b>                               | Specify the virtual router IP address for the VRRP interface.<br><br><div style="background-color: #f0f0f0; padding: 5px;"> <p> <b>Note</b></p> <p>Devices in the same VRRP group must be in the same subnet.</p> </div>  | Valid IP address             | N/A           |
| <b>Virtual Router ID</b>                        | Specify the virtual router ID to use for the VRRP interface. The virtual router ID is used to assign the virtual router to a VRRP group.<br><br><div style="background-color: #f0f0f0; padding: 5px;"> <p> <b>Note</b></p> <p>Devices that operate as master/backup should have the same ID. Each interface supports one virtual router ID.</p> </div> | 1-255                        | 1             |
| <b>Priority</b>                                 | Specify the priority of the VRRP interface. Higher numbers indicate higher priority, with 254 being the highest.<br><br><div style="background-color: #f0f0f0; padding: 5px;"> <p> <b>Note</b></p> <p>If multiple devices have the same priority, the device with the highest IP address will have priority.</p> </div>                               | 1-254                        | 100           |
| <b>Accept Mode</b>                              | Enable or disable Accept Mode for the VRRP interface. When enabled, the virtual router designated as the master will allow others to access its own virtual IP address.  | Enabled / Disabled           | Enabled       |
| <b>Preemption</b>                               | Enable or disable preemption for the VRRP interface. When enabled, preemption will decide if the master will retake authority or not after being unavailable.  | Enabled / Disabled           | Enabled       |
| <b>Preempt Delay (if Preemption is Enabled)</b> | Specify the preemption delay in seconds to use for the VRRP interface. The preempt delay is the amount of time the master will wait before retaking authority back in order to prevent the master from acting before the network connection is ready.  | 0-300 sec                    | 120           |

| UI Setting                    | Description  | Valid Range | Default Value |
|-------------------------------|--|-------------|---------------|
| <b>Advertisement Interval</b> | Specify the advertisement interval in milliseconds for the VRRP interface. This determines the interval for the master sending packets to all slave devices to inform them who the master device is. | 10-30000 ms | 100           |

## VRRP Tracking

### Note

If either Native Interface Tracking or Object Ping Tracking determines a connection failure, the VRRP status will be switched to INIT mode.

| UI Setting  | Description  | Valid Range                             | Default Value |
|---|--|---|---------------|
| <b>Native Tracking Interface</b>  | Disable or specify which interface to use for Native Interface Tracking for the VRRP interface. When enabled, if all interfaces on the device are disconnected, it will be considered to be a disconnection. | Disabled / Drop-down list of interfaces | Disabled      |
| <b>Target IP</b>  | Specify the target IP to ping to verify if the connection to the destination is working. Leaving this field empty or entering 0.0.0.0 will disable object ping tracking for the VRRP interface.              | Valid IP address                        | N/A           |
| <div style="background-color: #f0f0f0; padding: 5px;"> <p> <b>Note</b></p> <p>Moxa devices will decide which interface/source IP to use for pinging the target IP based on the routing table.</p> </div> |  |   |               |
| <b>Interval</b>   | Specify the interval in seconds the device will use for pinging the target IP.   | 1-100 sec                               | 1             |
| <b>Timeout</b>  | Specify the timeout duration in seconds the device will wait for a response before timing out.   | 1-100 sec                               | 3             |
| <b>Success Count</b>  | Specify the success count, which indicates how many responses the device must receive to consider the connection as working.   | 1-100                                   | 3             |
| <b>Failure Count</b>  | Specify the failure count, which indicates how many times the target IP fails to respond before the device considers the connection as not working.  | 1-100                                   | 3             |

## VRRP - Create Virtual Router

### Menu Path: Redundancy > Layer 3 Redundancy > VRRP - Settings

Clicking the **Add (+)** icon on the **Redundancy > Layer 3 Redundancy > VRRP - Settings** page will open this dialog box. This dialog lets you create a new virtual router for your device. Click **CREATE** to save your changes and add the new account.

#### **o** Limitations

You can create up to 16 virtual routers.

**Create Virtual Router**

**VRRP Interface Setting**

Status  
Disabled

Interface  
WAN

Virtual IP \*      Virtual Router ID \*      Priority \*  
1      1      100  
1 - 255      1 - 254

Accept Mode  
Enabled

Preemption      Preempt Delay \*  
Enabled      120  
0 - 300      sec.

Advertisement Interval \*  
100  
10 - 30000      millsec.

**VRRP Tracking**

Native Interface Tracking  
Disabled

**Object Ping Tracking**

Target IP  
Leave empty or set to 0.0.0.0 to disable



Interval \*      Timeout \*  
1      3  
1 - 100      sec.      1 - 100      sec.

Success Count \*      Failure Count \*  
3      3  
1 - 100      1 - 100

CANCEL      **CREATE**

## VRRP Interface Setting Entry

| UI Setting    | Description                           | Valid Range        | Default Value |
|---------------|---------------------------------------|--------------------|---------------|
| <b>Status</b> | Enable or disable the VRRP interface. | Enabled / Disabled | Disabled      |

| UI Setting                                      | Description   | Valid Range                  | Default Value |
|---|---|------------------------------|---------------|
| <b>Interface</b>                                | Specify which network interface to use for the VRRP interface.  | Drop-down list of interfaces |               |
| <b>Virtual IP</b>                               | Specify the virtual router IP address for the VRRP interface.<br><br><div style="background-color: #f0f0f0; padding: 5px;"> <p> <b>Note</b></p> <p>Devices in the same VRRP group must be in the same subnet.</p> </div>   | Valid IP address             | N/A           |
| <b>Virtual Router ID</b>                        | Specify the virtual router ID to use for the VRRP interface. The virtual router ID is used to assign the virtual router to a VRRP group.<br><br><div style="background-color: #f0f0f0; padding: 5px;"> <p> <b>Note</b></p> <p>Devices that operate as master/backup should have the same ID. Each interface supports one virtual router ID.</p> </div> | 1-255                        | 1             |
| <b>Priority</b>                                 | Specify the priority of the VRRP interface. Higher numbers indicate higher priority, with 254 being the highest.<br><br><div style="background-color: #f0f0f0; padding: 5px;"> <p> <b>Note</b></p> <p>If multiple devices have the same priority, the device with the highest IP address will have priority.</p> </div>                              | 1-254                        | 100           |
| <b>Accept Mode</b>                              | Enable or disable Accept Mode for the VRRP interface. When enabled, the virtual router designated as the master will allow others to access its own virtual IP address.   | Enabled / Disabled           | Enabled       |
| <b>Preemption</b>                               | Enable or disable preemption for the VRRP interface. When enabled, preemption will decide if the master will retake authority or not after being unavailable.   | Enabled / Disabled           | Enabled       |
| <b>Preempt Delay (if Preemption is Enabled)</b> | Specify the preemption delay in seconds to use for the VRRP interface. The preempt delay is the amount of time the master will wait before retaking authority back in order to prevent the master from acting before the network connection is ready.   | 0-300 sec                    | 120           |
| <b>Advertisement Interval</b>                   | Specify the advertisement interval in milliseconds for the VRRP interface. This determines the interval for the master sending packets to all slave devices to inform them who the master device is.  | 10-30000 ms                  | 100           |

## VRRP Tracking

### Note

If either Native Interface Tracking or Object Ping Tracking determines a connection failure, the VRRP status will be switched to INIT mode.

| UI Setting                       | Description  | Valid Range                             | Default Value |
|----------------------------------|--|---|---------------|
| <b>Native Tracking Interface</b> | Disable or specify which interface to use for Native Interface Tracking for the VRRP interface. When enabled, if all interfaces on the device are disconnected, it will be considered to be a disconnection.   | Disabled / Drop-down list of interfaces | Disabled      |
| <b>Target IP</b>                 | Specify the target IP to ping to verify if the connection to the destination is working. Leaving this field empty or entering 0.0.0.0 will disable object ping tracking for the VRRP interface.<br><div data-bbox="389 837 1046 1032" style="background-color: #f0f0f0; padding: 5px;"><h3> Note</h3><p>Moxa devices will decide which interface/source IP to use for pinging the target IP based on the routing table.</p></div> | Valid IP address                        | N/A           |
| <b>Interval</b>                  | Specify the interval in seconds the device will use for pinging the target IP.   | 1-100 sec                               | 1             |
| <b>Timeout</b>                   | Specify the timeout duration in seconds the device will wait for a response before timing out.   | 1-100 sec                               | 3             |
| <b>Success Count</b>             | Specify the success count, which indicates how many responses the device must receive to consider the connection as working.   | 1-100                                   | 3             |
| <b>Failure Count</b>             | Specify the failure count, which indicates how many times the target IP fails to respond before the device considers the connection as not working.  | 1-100                                   | 3             |

## Delete Virtual Router

### Menu Path: [Redundancy](#) > [Layer 3 Redundancy](#) > [VRRP - Settings](#)

You can delete VRRP interfaces by using the checkboxes to select the interfaces you want to delete, then clicking the **Delete** (  ) icon.

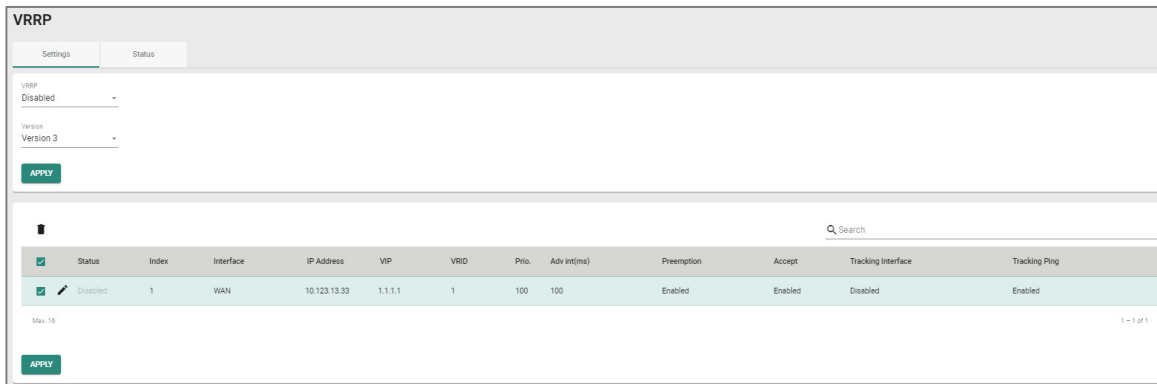

## VRRP - Status

**Menu Path: Redundancy > Layer 3 Redundancy > VRRP - Status**

This page lets you see the status of your device's VRRP interfaces.



| UI Setting       | Description   |
|------------------|---|
| <b>Status</b>    | Shows the status of the VRRP interface.   |
| <b>Index</b>     | Shows the index number used to identify the VRRP interface.   |
| <b>Interface</b> | Shows which network interface is used for the VRRP interface.   |
| <b>VRID</b>      | Shows the virtual router ID for the VRRP interface, which is used to assign the virtual router to a VRRP group.   |
| <b>State</b>     | Shows the state of the VRRP interface.<br><b>Init State:</b> This is the initial state when a virtual router starts up.<br><b>Master State:</b> The virtual router is acting as a master, and is responsible for forwarding packets sent to the virtual IP address and acting as the default gateway for the devices in the network.<br><b>Backup State:</b> The virtual router is in the backup state, and waiting to take over the master role if the current master fails. |



| UI Setting            | Description  |
|-----------------------|--|
| <b>Master Address</b> | Shows IP address of the current master for the VRRP interface. |

## WAN Redundancy

### Menu Path: [Redundancy](#) > [WAN Redundancy](#)

This section lets you configure the WAN Redundancy features of your device.

This page includes these tabs:

- Settings
- Status

#### **Note**

Please note that settings and available options will vary depending on the product model.

## WAN Redundancy - Settings

### Menu Path: [Redundancy](#) > [WAN Redundancy - Settings](#)

This page lets you configure the WAN Redundancy settings for your device.

## WAN Redundancy

Settings

Status

WAN Redundancy Mode \*

Disabled

WAN Switching Mode \*

Failback

Ping Check

Disabled

Ping Interval \*

5

1 - 3600

Ping Success Retry Times \*

3

sec.

1 - 10 times

Ping Failure Retry Times \*

3

1 - 10

times

Ping Timeout \*

5

1 - 10

sec.

APPLY

### WAN Backup Priority

Priority

Interface

WAN Redundancy

Host IP Address



1

Ethernet WAN 1

Enabled

0.0.0.0



2

Ethernet WAN 2

Disabled

0.0.0.0

WAN Redundancy Mode \*

Disabled

WAN Switching Mode \*

Failback

Ping Check

Disabled

Ping Interval \*

5

1 - 3600

Ping Success Retry Times \*

3

sec.

1 - 10 times

Ping Failure Retry Times \*

3

1 - 10

times

Ping Timeout \*

5

1 - 10



sec.

APPLY

| UI Setting                      | Description   | Valid Range         | Default Value |
|---------------------------------|---|---------------------|---------------|
| <b>WAN Redundancy Mode</b>      | <p>Select the WAN Redundancy Mode.</p> <p><b>Disabled:</b> Disable redundancy. If the connection on the WAN interface becomes unavailable, the connection will be lost.</p> <p><b>Backup:</b> If the connection on the active WAN interface becomes unavailable, the system will automatically switch to the other WAN interface to recover the connection.</p>                                 | Disabled / Backup   | Disabled      |
| <b>WAN Switching Mode</b>       | <p>Select the WAN Switching Mode.</p> <p><b>Failover:</b> The system will only switch to the backup WAN interface when the current WAN interface becomes unavailable.</p> <p><b>Failback:</b> The system will switch to the backup WAN interface when the current WAN interface becomes unavailable. When the original higher priority WAN interface recovers, the system will switch back.</p> | Failover / Failback | Failback      |
| <b>Ping Check</b>               | Enable or disable ping checks to determine whether a connection is still alive.   | Enabled/Disabled    | Disabled      |
| <b>Ping Interval</b>            | Specify the interval in seconds at which the device will perform a connection alive check.  | 1 to 3600           | 5             |
| <b>Ping Failure Retry Times</b> | Specify the number of times the device will ping the configured host IP through the active WAN interface. If the ping check consecutively fails for the specified number of retries, the device will consider the WAN interface unavailable and will switch to the backup WAN interface. The host IP is configured per WAN interface.   | 1 to 10             | 3             |
| <b>Ping Success Retry Times</b> | Specify the number of times the device will ping the configured host IP through the higher priority WAN interface in Failback mode. If the ping check consecutively succeeds for the specified number of retries, the device will consider the WAN interface recovered and will switch back to that WAN interface. The host IP is configured per WAN interface.                                 | 1 to 10             | 3             |
| <b>Ping Timeout</b>             | Specify the timeout duration in seconds the device will wait for a response before timing out.  | 1 to 10             | 5             |

**WAN Backup Priority**

☰

| Priority  | Interface    | WAN Redundancy | Host IP Address |
|---|--------------|----------------|-----------------|
|  1 | Ethernet WAN | Enabled        | 1.1.1.1         |
|  2 | Cellular     | Disabled       | 0.0.0.0         |

| UI Setting             | Description                                 |
|------------------------|---|
| <b>Priority</b>        | Shows the WAN Backup Priority.              |
| <b>Interface</b>       | Shows the interface of WAN Backup Priority. |
| <b>WAN Redundancy</b>  | Shows the status of WAN Redundancy.         |
| <b>Host IP Address</b> | Shows the Host IP Address.                  |

## WAN Redundancy - Edit WAN Backup Priority

**Menu Path:** Redundancy > WAN Redundancy > Settings

Clicking the **Edit** (  ) icon for an entry on the **Redundancy > WAN Redundancy > Settings** page will open this dialog box. This dialog lets you edit the WAN Redundancy settings for an interface. Click **APPLY** to save your changes.

**Edit Cellular Interface Settings**

WAN Redundancy \*

Disabled 

Host IP Address

0.0.0.0

CANCEL **APPLY**

| UI Setting             | Description   | Valid Range        | Default Value |
|------------------------|---|--------------------|---------------|
| <b>WAN Redundancy</b>  | Enable or disable using WAN Redundancy for the interface.         | Enabled / Disabled | Disabled      |
| <b>Host IP Address</b> | Specify the IP address for performing the connection alive check. | Valid IP address   | 0.0.0.0       |

## WAN Redundancy - Status

**Menu Path:** Redundancy > WAN Redundancy - Status

This page lets you see the status of your device's WAN Redundancy.

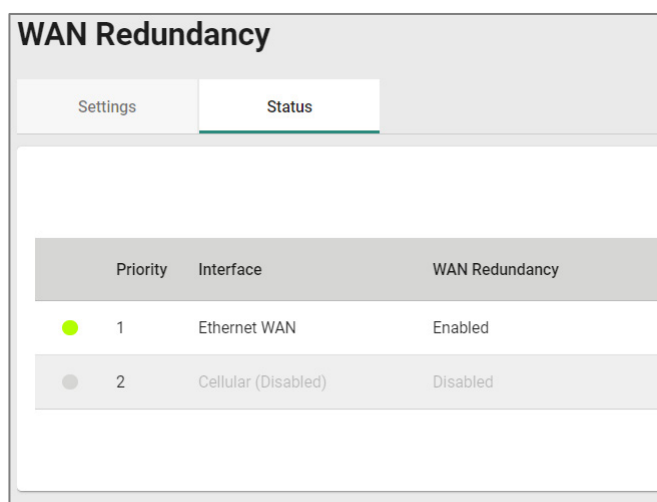

| WAN Redundancy |                     |                |
|----------------|---------------------|----------------|
| Settings       | Status              |                |
| Priority       | Interface           | WAN Redundancy |
| ● 1            | Ethernet WAN        | Enabled        |
| ● 2            | Cellular (Disabled) | Disabled       |

| UI Setting            | Description   |
|-----------------------|---|
| <b>Light</b>          | Green: the WAN interface is in use.<br>Gray: the WAN interface is not in use. |
| <b>Priority</b>       | Shows the priority of WAN Redundancy.   |
| <b>Interface</b>      | Shows the interface for WAN Redundancy.                                       |
| <b>WAN Redundancy</b> | Shows the status of WAN Redundancy.   |

# Network Service

## Menu Path: Network Service

The Network Service settings area lets you configure the main system settings for your device.

This settings area includes these sections:

- DHCP Server
- Dynamic DNS
- DNS Server

## Network Service - User Privileges

Privileges to Network Service settings are granted to the different authority levels as follows. Refer to [System > Account Management > User Accounts](#) for more information on user accounts.

| Settings    | Admin | Supervisor | User |
|-------------|-------|------------|------|
| DHCP Server | R/W   | R/W        | R    |
| Dynamic DNS | R/W   | R/W        | R    |
| DNS Server  | R/W   | R/W        | R    |

## DHCP Server

### Menu Path: Network Service > DHCP Server

This page lets you manage the DHCP server settings of your device.

This page includes these tabs:

- General
- DHCP
- MAC-based IP Assignment

- Port-based IP Assignment
- Lease Table
- DHCP Relay Agent

## DHCP Server - General

**Menu Path: Network Service > DHCP Server - General**

This page lets you enable the DHCP server feature of your device. Click **APPLY** to save your changes.

| UI Setting  | Description  | Valid Range   | Default Value |
|-------------|--|---|---------------|
| <b>Mode</b> | Select the DHCP Server Mode. Each mode has its own configuration settings. | Disabled / DHCP / MAC-based assignment / Port-based IP assignment | Disabled      |

## DHCP

**Menu Path: Network Service > DHCP Server - DHCP**

This page lets you set up your device's DHCP server settings to automatically assign an IP address from a user-configured IP address pool to connected Ethernet devices.

### Note

The DHCP Server is only available for LAN interfaces. The DHCP pool's Starting/Ending IP Address must be in the same LAN subnet.

## 🔒 Limitations

You can create up to 32 DHCP server pools.

## DHCP Server Pools

| Status   | Pool IP Range                   | Subnet Mask   | Lease Time (min.) | Default Gateway | DNS Server 1 | DNS Server 2 | NTP Server |
|----------|---------------------------------|---------------|-------------------|-----------------|--------------|--------------|------------|
| Disabled | 192.168.127.1 - 192.168.127.253 | 255.255.255.0 | 60                | 192.168.127.254 | 0.0.0.0      | 0.0.0.0      | 0.0.0.0    |

| UI Setting           | Description  |
|----------------------|--|
| <b>Status</b>        | Shows the status of the DHCP server pool.  |
| <b>Pool IP Range</b> | Shows the IP range of the pool.  |
| <b>Subnet Mask</b>   | Shows the subnet mask to use for DHCP clients in the pool.                             |
| <b>Lease Time</b>    | Shows the lease time to use for IP addresses assigned by the DHCP server for the pool. |
| <b>DNS Server 1</b>  | Shows the IP address to use for the first DNS server for DHCP clients in the pool.     |
| <b>DNS Server 2</b>  | Shows the IP address to use for the second DNS server for DHCP clients in the pool.    |
| <b>NTP Server</b>    | Shows the IP address to use for the NTP server for DHCP clients in the pool.           |

## Edit DHCP Server Pool

### Menu Path: Network Service > DHCP Server - DHCP

Clicking the **Edit** (✎) icon for an pool on the **Network Service > DHCP Server - DHCP** page will open this dialog box. This dialog lets you edit an existing DHCP server pool. Click **APPLY** to save your changes.



### Edit DHCP Server Pool

Status \*  
Disabled

Starting IP Address \*      Subnet Mask \*  
192.168.127.1      24 (255.255.255.0)

Ending IP Address \*  
192.168.127.253

Default Gateway  
192.168.127.254

Lease Time \*  
60  
5 - 527039 min.

DNS Server 1      DNS Server 2  
0.0.0.0      0.0.0.0

NTP Server  
0.0.0.0

CANCEL
APPLY

| UI Setting                 | Description   | Valid Range        | Default Value |
|----------------------------|---|--------------------|---------------|
| <b>Status</b>              | Enable or disable DHCP server functionality.  | Enabled / Disabled | N/A           |
| <b>Starting IP Address</b> | Specify the starting IP address of the DHCP IP pool.  | Valid IP address   | N/A           |
| <b>Subnet Mask</b>         | Specify the subnet mask for DHCP clients in the pool.<br><br><div style="background-color: #f0f0f0; padding: 10px; border: 1px solid #ccc;"> <p><b>Note</b></p> <p>When configuring the DHCP Server, ensure the subnet mask is correctly set and the starting IP address, ending IP addresses, and IP addresses of all devices in the pool fall within this range.</p> <p>Exclude the reserved .0 (network) and .255 (broadcast) addresses to avoid conflicts.</p> </div> | Valid subnet mask  | N/A           |
| <b>Ending IP Address</b>   | Specify the ending IP address of the DHCP IP pool.  | Valid IP address   | N/A           |
| <b>Default Gateway</b>     | Specify the default gateway to use for DHCP clients in the pool.  | Valid IP address   | N/A           |
| <b>Lease Time</b>          | Specify the lease time in minutes to use for IP addresses assigned to DHCP clients in the pool.   | 5 to 527039        | 1440          |

| UI Setting          | Description   | Valid Range      | Default Value |
|---------------------|---|------------------|---------------|
| <b>DNS Server 1</b> | Specify the IP address to use for the first DNS server for DHCP clients in the pool.  | Valid IP address | N/A           |
| <b>DNS Server 2</b> | Specify the IP address to use for the second DNS server for DHCP clients in the pool. | Valid IP address | N/A           |
| <b>NTP Server</b>   | Specify the IP address to use for the NTP server for DHCP clients in the pool.        | Valid IP address | N/A           |

## DHCP - Create DHCP Server Pool

### Menu Path: Network Service > DHCP Server - DHCP

Clicking the Add (/) icon on the Network Service > DHCP Server - DHCP page will open this dialog box. This dialog lets you create a new DHCP server pool. Click CREATE to save your changes and add the new account.

#### Create DHCP Server Pool

Status \*  
Enabled ▼

Starting IP Address \*      Subnet Mask \* ▼

Ending IP Address \*

Default Gateway

Lease Time \*  
1440  
5 - 527039 min.

DNS Server 1      DNS Server 2

NTP Server

CANCEL      CREATE

| UI Setting                 | Description  | Valid Range        | Default Value |
|----------------------------|--|--------------------|---------------|
| <b>Status</b>              | Enable or disable DHCP server functionality.   | Enabled / Disabled | N/A           |
| <b>Starting IP Address</b> | Specify the starting IP address of the DHCP IP pool.   | Valid IP address   | N/A           |
| <b>Subnet Mask</b>         | Specify the subnet mask for DHCP clients in the pool.<br><br><div style="background-color: #f0f0f0; padding: 5px; margin-top: 10px;"> <p><b>Note</b></p> <p>When configuring the DHCP Server, ensure the subnet mask is correctly set and the starting IP address, ending IP addresses, and IP addresses of all devices in the pool fall within this range.</p> <p>Exclude the reserved .0 (network) and .255 (broadcast) addresses to avoid conflicts.</p> </div> | Valid subnet mask  | N/A           |
| <b>Ending IP Address</b>   | Specify the ending IP address of the DHCP IP pool.   | Valid IP address   | N/A           |
| <b>Default Gateway</b>     | Specify the default gateway to use for DHCP clients in the pool.   | Valid IP address   | N/A           |
| <b>Lease Time</b>          | Specify the lease time in minutes to use for IP addresses assigned to DHCP clients in the pool.  | 5 to 527039        | 1440          |
| <b>DNS Server 1</b>        | Specify the IP address to use for the first DNS server for DHCP clients in the pool.   | Valid IP address   | N/A           |
| <b>DNS Server 2</b>        | Specify the IP address to use for the second DNS server for DHCP clients in the pool.  | Valid IP address   | N/A           |
| <b>NTP Server</b>          | Specify the IP address to use for the NTP server for DHCP clients in the pool.   | Valid IP address   | N/A           |

## DHCP - Delete DHCP Server Pool

### Menu Path: Network Service > DHCP Server - DHCP

You can delete a DHCP server pool by clicking the **Delete (🗑)** icon for the pool.

**DHCP Server**

General | **DHCP** | MAC-based IP Assignment | Port-based IP Assignment | Lease Table | DHCP Relay Agent

+ Search

| Status       | Pool IP Range                   | Subnet Mask   | Lease Time (min.) | Default Gateway | DNS Server 1 | DNS Server 2 | NTP Server |
|--------------|---------------------------------|---------------|-------------------|-----------------|--------------|--------------|------------|
| ✎ 🗑 Disabled | 192.168.127.1 - 192.168.127.253 | 255.255.255.0 | 60                | 192.168.127.254 | 0.0.0.0      | 0.0.0.0      | 0.0.0.0    |

Max. 32 1 - 1 of 1 < >

## DHCP Server - MAC-based IP Assignment

**Menu Path: Network Service > DHCP Server - MAC-based IP Assignment**

This page lets you manage the DHCP server's MAC-based IP assignments.

**Note**

MAC-based IP assignment is a method of managing IP address allocation on a DHCP server by associating specific IP addresses with the unique MAC addresses of devices on a network. This approach allows network administrators to ensure that certain devices always receive the same IP address, regardless of their connection order or lease duration. By configuring the DHCP server with a table of MAC addresses and their corresponding IP addresses, administrators can have greater control over IP address allocation and enhance network security and management.

**Limitations**

You can create up to 256 MAC-based IP assignments.

**DHCP Server**

General | DHCP | **MAC-based IP Assignment** | Port-based IP Assignment | Lease Table | DHCP Relay Agent

+ Search

| <input type="checkbox"/> | Status       | Name               | IP Address      | Subnet Mask   | MAC Address       | Lease Time (min.) | Default Gateway | DNS Server 1 | DNS Server 2 |
|--------------------------|--------------|--------------------|-----------------|---------------|-------------------|-------------------|-----------------|--------------|--------------|
| <input type="checkbox"/> | ✎ 🗑 Disabled | UserManualCASEtest | 192.168.127.101 | 255.255.255.0 | 00:09:ad:00:aa:01 | 1440              | 0.0.0.0         | 0.0.0.0      | 0.0.0.0      |

Max. 256 Items per page: 50 1 - 1 of 1 < >

| UI Setting             | Description  |
|------------------------|--|
| <b>Status</b>          | Shows the status of the MAC-based IP assignment.                   |
| <b>Name</b>            | Shows the hostname for the device.                                 |
| <b>IP Address</b>      | Shows the IP address of the device.                                |
| <b>Subnet Mask</b>     | Shows the subnet mask of the device.                               |
| <b>MAC Address</b>     | Shows the MAC address of the device.                               |
| <b>Default Gateway</b> | Shows the default gateway of the device.                           |
| <b>Lease Time</b>      | Shows the lease time for IP addresses assigned by the DHCP server. |
| <b>DNS Server 1</b>    | Shows the IP address for the first DNS server.                     |
| <b>DNS Server 2</b>    | Shows the IP address for the second DNS server.                    |
| <b>NTP Server</b>      | Shows the IP address for the NTP server.                           |

## MAC-based IP Assignment - Edit Entry

### Menu Path: Network Service > DHCP Server - MAC-based IP Assignment

Clicking the **Edit** (↗) icon for an assignment on the **Network Service > DHCP Server - MAC-based IP Assignment** page will open this dialog box. This dialog lets you edit an existing IP assignment. Click **APPLY** to save your changes.

### Edit Entry Settings

Status  
Disabled ▼

Name \*  
ExistingAssignment 18 / 63

IP Address \* Subnet Mask \*  
192.168.127.101 24 (255.255.255.0) ▼

MAC Address \*  
00:00:00:00:00:00

Default Gateway  
0.0.0.0

Lease Time \*  
1440 min.

DNS Server 1 DNS Server 2  
0.0.0.0 0.0.0.0

NTP Server  
0.0.0.0

CANCEL
APPLY

| UI Setting             | Description  | Valid Range        | Default Value |
|------------------------|--|--------------------|---------------|
| <b>Status</b>          | Enable or disable this MAC-based IP assignment.                | Enabled / Disabled | N/A           |
| <b>Name</b>            | Enter a hostname for the IP assignment.                        | Max. 63 characters | N/A           |
| <b>IP Address</b>      | Specify the IP address for the IP assignment.                  | Valid IP address   | N/A           |
| <b>Subnet Mask</b>     | Specify the subnet mask for the IP assignment.                 | Valid subnet mask  | N/A           |
| <b>MAC Address</b>     | Specify the MAC address that this IP assignment will apply to. | Valid MAC address  | N/A           |
| <b>Default Gateway</b> | Specify the default gateway for the IP assignment.             | Valid IP address   | N/A           |
| <b>Lease Time</b>      | Specify the lease time for for the IP assignment.              | 5 - 99999 minutes  | 1440          |
| <b>DNS Server 1</b>    | Specify the primary DNS server for the IP assignment.          | Valid IP address   | N/A           |
| <b>DNS Server 2</b>    | Specify the secondary DNS server for the IP assignment.        | Valid IP address   | N/A           |

| UI Setting        | Description                                   | Valid Range      | Default Value |
|-------------------|---|------------------|---------------|
| <b>NTP Server</b> | Specify the NTP server for the IP assignment. | Valid IP address | N/A           |

## MAC-based IP Assignment - Create Entry

### Menu Path: Network Service > DHCP Server - MAC-based IP Assignment

Clicking the **Add (+)** icon on the **Network Service > DHCP Server - MAC-based IP Assignment** page will open this dialog box. This dialog lets you add a new MAC-based IP assignment. Click **CREATE** to save your changes and add the new assignment.

**Create Entry**

Status

Name \*

IP Address \*  Subnet Mask \*

MAC Address \*

Default Gateway

Lease Time \*  min.  
5 - 99999

DNS Server 1  DNS Server 2

NTP Server

| UI Setting        | Description                                     | Valid Range        | Default Value |
|-------------------|---|--------------------|---------------|
| <b>Status</b>     | Enable or disable this MAC-based IP assignment. | Enabled / Disabled | N/A           |
| <b>Name</b>       | Enter a hostname for the IP assignment.         | Max. 63 characters | N/A           |
| <b>IP Address</b> | Specify the IP address for the IP assignment.   | Valid IP address   | N/A           |

| UI Setting             | Description  | Valid Range       | Default Value |
|------------------------|--|-------------------|---------------|
| <b>Subnet Mask</b>     | Specify the subnet mask for the IP assignment.                 | Valid subnet mask | N/A           |
| <b>MAC Address</b>     | Specify the MAC address that this IP assignment will apply to. | Valid MAC address | N/A           |
| <b>Default Gateway</b> | Specify the default gateway for the IP assignment.             | Valid IP address  | N/A           |
| <b>Lease Time</b>      | Specify the lease time for for the IP assignment.              | 5 - 99999 minutes | 1440          |
| <b>DNS Server 1</b>    | Specify the primary DNS server for the IP assignment.          | Valid IP address  | N/A           |
| <b>DNS Server 2</b>    | Specify the secondary DNS server for the IP assignment.        | Valid IP address  | N/A           |
| <b>NTP Server</b>      | Specify the NTP server for the IP assignment.                  | Valid IP address  | N/A           |

## MAC-based IP Assignment - Delete Entry

### Menu Path: Network Service > DHCP Server - MAC-based IP Assignment

You can delete a MAC-based IP assignment by using the checkboxes to select the entries you want to delete, then clicking the **Delete** (🗑️) icon.

The screenshot shows the DHCP Server configuration interface. The 'MAC-based IP Assignment' tab is selected. A table displays the following entry:

|                                     | Status   | Name               | IP Address      | Subnet Mask   | MAC Address       | Lease Time (min.) | Default Gateway | DNS Server 1 | DNS Server 2 |
|-------------------------------------|----------|--------------------|-----------------|---------------|-------------------|-------------------|-----------------|--------------|--------------|
| <input checked="" type="checkbox"/> | Disabled | UserManualCASEtest | 192.168.127.101 | 255.255.255.0 | 00:09:ad:00:aa:01 | 1440              | 0.0.0.0         | 0.0.0.0      | 0.0.0.0      |

At the bottom of the table, there is a pagination control showing 'Max. 256' and 'Items per page: 50'.

## DHCP Server - Port-based IP Assignment

### Menu Path: Network Service > DHCP Server - Port-based IP Assignment

This page lets you manage port-based IP assignment for your device's DHCP server.



### Note

Port-based IP assignment is a method of managing IP address allocation on a DHCP server by associating specific IP addresses with the physical ports on network equipment, such as switches or routers. This approach provides network administrators with the ability to assign predetermined IP addresses to devices based on the network port they are connected to.

### Limitations

You can create up to 10 port-based IP assignments.

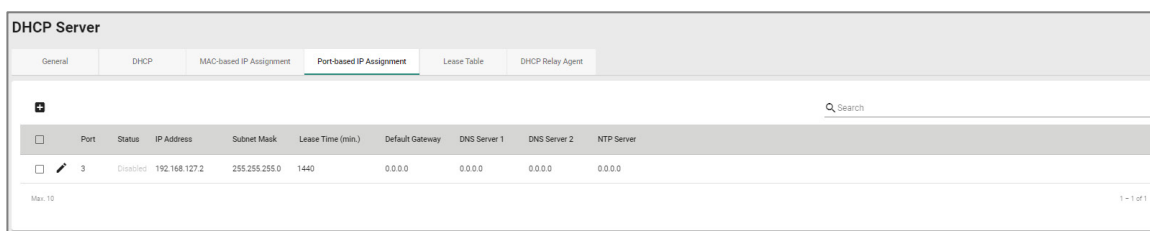

The screenshot shows the DHCP Server configuration interface. The 'Port-based IP Assignment' tab is active. A table lists one assignment with the following details:

| Port | Status   | IP Address    | Subnet Mask   | Lease Time (min.) | Default Gateway | DNS Server 1 | DNS Server 2 | NTP Server |
|------|----------|---------------|---------------|-------------------|-----------------|--------------|--------------|------------|
| 3    | Disabled | 192.168.127.2 | 255.255.255.0 | 1440              | 0.0.0.0         | 0.0.0.0      | 0.0.0.0      | 0.0.0.0    |

### Limitations

You can create up to 10 port-based IP assignments.

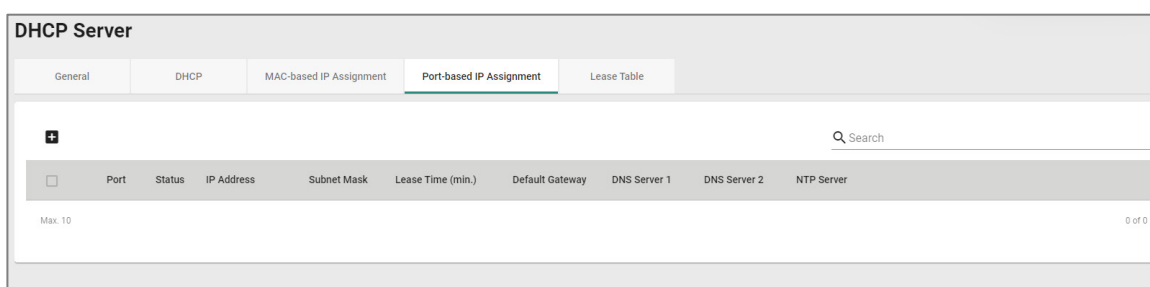

The screenshot shows the DHCP Server configuration interface. The 'Port-based IP Assignment' tab is active. The table below it is empty, indicating no assignments are currently configured.

| Port | Status | IP Address | Subnet Mask | Lease Time (min.) | Default Gateway | DNS Server 1 | DNS Server 2 | NTP Server |
|------|--------|------------|-------------|-------------------|-----------------|--------------|--------------|------------|
|------|--------|------------|-------------|-------------------|-----------------|--------------|--------------|------------|

### UI Setting

### Description

#### Status

Shows the status of Port-based IP Assignment.

#### Port

Shows the physical port on the device to associate the IP with.

| UI Setting             | Description  |
|------------------------|--|
| <b>IP Address</b>      | Shows the IP address of the device.                                |
| <b>Subnet Mask</b>     | Shows the subnet mask of the device.                               |
| <b>Default Gateway</b> | Shows the default gateway of the device.                           |
| <b>Lease Time</b>      | Shows the lease time for IP addresses assigned by the DHCP server. |
| <b>DNS Server 1</b>    | Shows the IP address for the first DNS server.                     |
| <b>DNS Server 2</b>    | Shows the IP address for the second DNS server.                    |
| <b>NTP Server</b>      | Shows the IP address for the NTP server.                           |

## Edit Port-based IP Assignment

### Menu Path: Network Service > DHCP Server - Port-based IP Assignment

Clicking the **Edit (✎)** icon for an entry on the **Network Service > DHCP Server - Port-based IP Assignment** page will open this dialog box. This dialog lets you edit an existing port-based IP assignment. Click **APPLY** to save your changes.

| UI Setting    | Description   | Valid Range             | Default Value |
|---------------|---|-------------------------|---------------|
| <b>Status</b> | Enable or disable this port-based IP assignment.                                | Enabled / Disabled      | N/A           |
| <b>Port</b>   | Select the physical port on the device to associate the IP with for this entry. | Drop-down list of ports | N/A           |

| UI Setting             | Description   | Valid Range       | Default Value |
|------------------------|---|-------------------|---------------|
| <b>IP Address</b>      | Specify the IP address of the connected device for this entry.                      | Valid IP address  | N/A           |
| <b>Subnet Mask</b>     | Specify the subnet mask of the connected device for this entry.                     | Valid subnet mask | N/A           |
| <b>Default Gateway</b> | Specify the default gateway of the connected device for this entry.                 | Valid IP address  | N/A           |
| <b>Lease Time</b>      | Specify the lease time for IP addresses assigned by the DHCP server for this entry. | 5 - 99999 minutes | 1440          |
| <b>DNS Server 1</b>    | Specify the IP address for the first DNS server for DHCP clients for this entry.    | Valid IP address  | N/A           |
| <b>DNS Server 2</b>    | Specify the IP address for the second DNS server for DHCP clients for this entry.   | Valid IP address  | N/A           |
| <b>NTP Server</b>      | Specify the IP address for the NTP server for DHCP clients for this entry.          | Valid IP address  | N/A           |

## Create Port-based IP Assignment

### Menu Path: Network Service > DHCP Server - Port-based IP Assignment

Clicking the Add (/) icon on the Network Service > DHCP Server - Port-based IP Assignment page will open this dialog box. This dialog lets you create a new port-based IP assignment. Click CREATE to save your changes and add the new account.

### Create Entry

Status

Port \*

IP Address \*  Subnet Mask \*

Default Gateway

Lease Time \*  
1440  
5 - 99999 min.

DNS Server 1  DNS Server 2

NTP Server

| UI Setting             | Description   | Valid Range             | Default Value |
|------------------------|---|-------------------------|---------------|
| <b>Status</b>          | Enable or disable this port-based IP assignment.                                    | Enabled / Disabled      | N/A           |
| <b>Port</b>            | Select the physical port on the device to associate the IP with for this entry.     | Drop-down list of ports | N/A           |
| <b>IP Address</b>      | Specify the IP address of the connected device for this entry.                      | Valid IP address        | N/A           |
| <b>Subnet Mask</b>     | Specify the subnet mask of the connected device for this entry.                     | Valid subnet mask       | N/A           |
| <b>Default Gateway</b> | Specify the default gateway of the connected device for this entry.                 | Valid IP address        | N/A           |
| <b>Lease Time</b>      | Specify the lease time for IP addresses assigned by the DHCP server for this entry. | 5 - 99999 minutes       | 1440          |
| <b>DNS Server 1</b>    | Specify the IP address for the first DNS server for DHCP clients for this entry.    | Valid IP address        | N/A           |
| <b>DNS Server 2</b>    | Specify the IP address for the second DNS server for DHCP clients for this entry.   | Valid IP address        | N/A           |
| <b>NTP Server</b>      | Specify the IP address for the NTP server for DHCP clients for this entry.          | Valid IP address        | N/A           |

## Delete Port-based IP Assignment

### Menu Path: Network Service > DHCP Server - Port-based IP Assignment

You can delete a port-based IP assignment by using the checkboxes to select the entries you want to delete, then clicking the **Delete** (  ) icon.

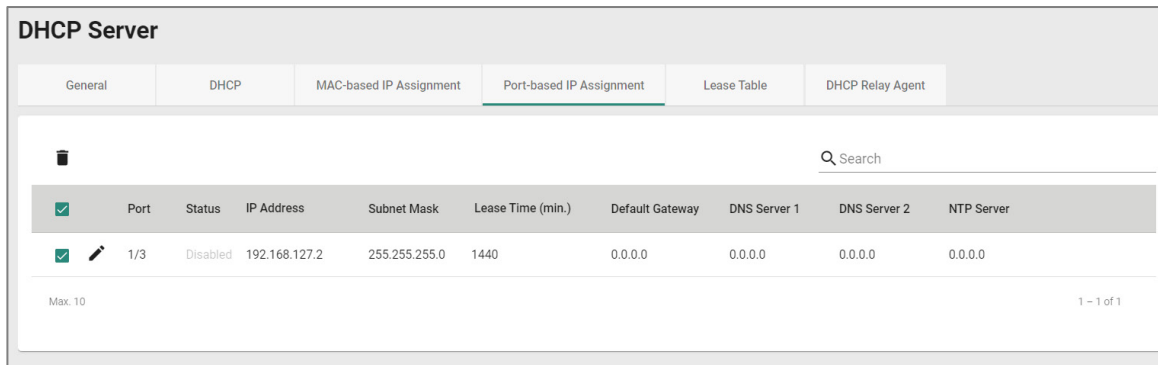

**DHCP Server**

General | DHCP | MAC-based IP Assignment | **Port-based IP Assignment** | Lease Table | DHCP Relay Agent



| <input checked="" type="checkbox"/> | Port | Status   | IP Address    | Subnet Mask   | Lease Time (min.) | Default Gateway | DNS Server 1 | DNS Server 2 | NTP Server |
|-------------------------------------|------|----------|---------------|---------------|-------------------|-----------------|--------------|--------------|------------|
| <input checked="" type="checkbox"/> | 1/3  | Disabled | 192.168.127.2 | 255.255.255.0 | 1440              | 0.0.0.0         | 0.0.0.0      | 0.0.0.0      | 0.0.0.0    |

Max. 10 1 - 1 of 1

## DHCP Server - Lease Table

### Menu Path: Network Service > DHCP Server - Lease Table

This page lets you see an overview of the device's current DHCP clients.

## Lease Table

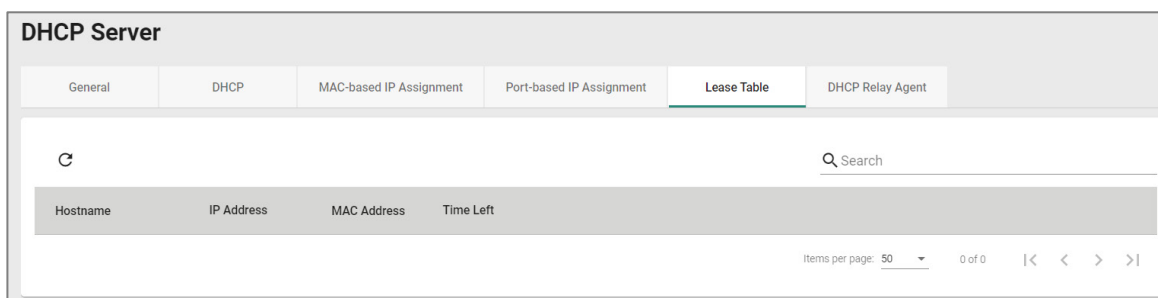

**DHCP Server**

General | DHCP | MAC-based IP Assignment | Port-based IP Assignment | **Lease Table** | DHCP Relay Agent



| Hostname | IP Address | MAC Address | Time Left |
|----------|------------|-------------|-----------|
|----------|------------|-------------|-----------|

Items per page: 50 0 of 0 |< < > >|

| UI Setting         | Description                              |
|--------------------|--|
| <b>Hostname</b>    | Shows the hostname of the DHCP lease.    |
| <b>IP Address</b>  | Shows the IP address of the DHCP lease.  |
| <b>MAC Address</b> | Shows the MAC address of the DHCP lease. |

| UI Setting       | Description                             |
|------------------|---|
| <b>Time Left</b> | Shows the time left for the DHCP lease. |

## DHCP Relay Agent

**Menu Path: Network Service > DHCP Server - DHCP Relay Agent**

This page allows you to configure the DHCP relay agent, including the settings for remote DHCP server(s) and option-82 related attributes.

### DHCP Relay Agent Settings

**DHCP Server**

General
DHCP
MAC-based IP Assignment
Port-based IP Assignment
Lease Table
DHCP Relay Agent

**Server IP Address**

Interface ▼

DHCP Relay Server-1 \*  
0.0.0.0

DHCP Relay Server-2 \*  
0.0.0.0

DHCP Relay Server-3 \*  
0.0.0.0

DHCP Relay Server-4 \*  
0.0.0.0

**DHCP Option 82**

Enable Option 82 \*    Type \*    Interface \*

Enabled    Interface    LAN

Value    Display

192.168.127.254    c0a87ffe

15 / 32

APPLY

### Server IP Address











| UI Setting       | Description                               | Valid Range                  | Default Value |
|------------------|---|------------------------------|---------------|
| <b>Interface</b> | Select a preconfigured network interface. | Drop-down menu of interfaces | None          |

| UI Setting                 | Description                                    | Valid Range      | Default Value |
|----------------------------|--|------------------|---------------|
| <b>DHCP Relay Server-1</b> | Specify the IP address of the 1st DHCP server. | Valid IP address | 0.0.0.0       |
| <b>DHCP Relay Server-2</b> | Specify the IP address of the 2nd DHCP server. | Valid IP address | 0.0.0.0       |
| <b>DHCP Relay Server-3</b> | Specify the IP address of the 3rd DHCP server. | Valid IP address | 0.0.0.0       |
| <b>DHCP Relay Server-4</b> | Specify the IP address of the 4th DHCP server. | Valid IP address | 0.0.0.0       |

## DHCP Option 82

| UI Setting                 | Description  | Valid Range                         | Default Value                       |
|----------------------------|--|-------------------------------------|-------------------------------------|
| <b>Enable Option 82</b>    | Enable or disable DHCP Option 82.  | Enabled / Disabled                  | Disabled                            |
| <b>Type</b>                | Specify the type of DHCP Option 82 to use.<br><b>Interface:</b> Uses the router's interfaces as the remote ID sub.<br><b>MAC:</b> Uses the router's MAC addresses as the remote ID sub.<br><b>Client-ID:</b> Uses a combination of the router's MAC address and IP address as the remote ID sub.<br><b>Other:</b> Uses the user-designated ID sub. | Interface / MAC / Client-ID / Other | Interface                           |
| <b>Interface</b>           | Select the interface to use for DHCP Option 82.  | Drop-down menu of interfaces        | N/A                                 |
| <b>Value</b>               | Shows the corresponding value of the selected <b>Type</b> .<br>If <b>Type</b> is <b>Other</b> , specify the value to use.  | 0 to 32 characters                  | Depends on the selected <b>Type</b> |
| <b>Display (View-only)</b> | Shows the <b>Value</b> in hexadecimal.   | N/A                                 | N/A                                 |

## DHCP Function Table

| DHCP Function Table  |            |           | Search |
|--|------------|-----------|--------|
| Port   | Circuit-ID | Option 82 |        |
|  1/1  | 01000101   | Disabled  |        |
|  1/2  | 01000102   | Disabled  |        |
|  1/3  | 01000103   | Disabled  |        |
|  1/4  | 01000104   | Disabled  |        |
|  1/5  | 01000105   | Disabled  |        |
|  1/6  | 01000106   | Disabled  |        |
|  1/7  | 01000107   | Disabled  |        |
|  1/8  | 01000208   | Disabled  |        |
|  1/9  | 01000109   | Disabled  |        |
|  1/10 | 0100010a   | Disabled  |        |

1 - 10 of 10

| UI Setting        | Description  |
|-------------------|--|
| <b>Port</b>       | Shows the number of the port the entry is for.               |
| <b>Circuit-ID</b> | Shows the Circuit-ID of the port.                            |
| <b>Option 82</b>  | Shows whether Option 82 is enabled or disabled for the port. |

## Dynamic DNS

### Menu Path: Network Service > Dynamic DNS

This page lets you configure your device to use a free dynamic DNS service to enable you to access your device through a domain name rather than an IP. Click **APPLY** to save your changes.



## Dynamic DNS

Service \*  
Disabled ▼

Service Name

Username  
 0 / 45

Password   
 0 / 45

Confirm Password   
 0 / 45

Domain Name  
 0 / 45

APPLY

| UI Setting                      | Description   | Valid Range  | Default Value |
|---------------------------------|---|--|---------------|
| <b>Service</b>                  | Select a dynamic DNS service to use, or disable dynamic DNS.                              | Disabled / freedns.afraid.org / 3322.org / DynDns.org / NO-IP.com            | Disabled      |
| <b>Service Name (View-only)</b> | Shows the name of the selected dynamic DNS service.                                       | freedns.afraid.org / www.3322.org / members.dyndns.org / dynupdate.no-ip.com | N/A           |
| <b>Username</b>                 | Specify the username to connect to the dynamic DNS service.                               | 1 to 45 characters   | N/A           |
| <b>Password</b>                 | Specify the password to connect to the dynamic DNS service.                               | 1 to 45 characters   | N/A           |
| <b>Confirm Password</b>         | Confirm the password to connect to the dynamic DNS service.                               | 1 to 45 characters   | N/A           |
| <b>Domain Name</b>              | Specify the domain name to use to connect to your device through the dynamic DNS service. | 1 to 45 characters   | N/A           |

# DNS Server

**Menu Path:** [Network Service > DNS Server](#)

This page lets you configure the DNS server settings.

This page includes these tabs:

- Global
- Settings
- Status

 **Note**

Availability of this feature may vary depending on your product model and version.

## DNS Server - Global

**Menu Path:** [Network Service > DNS Server - Global](#)

This page lets you configure the DNS server related settings. Click **APPLY** to save your changes.

## DNS Server Settings

### DNS Server

- Global
- Settings
- Status

DNS Server \*  
Disabled ▼

DNS Reverse Lookup \*  
Disabled ▼

**APPLY**

| UI Setting                | Description  | Valid Range        | Default Value |
|---------------------------|--|--------------------|---------------|
| <b>DNS Server</b>         | Enable or disable the DNS server for your device.  | Enabled / Disabled | Disabled      |
| <b>DNS Reverse Lookup</b> | Enable or disable DNS reverse lookup for your device. DNS reverse lookup allows the router to identify the hostname (device name) associated with a known IP address on the network. | Enabled / Disabled | Disabled      |

## DNS Server - Settings

**Menu Path:** [Network Service](#) > [DNS Server - Settings](#)

This page lets you configure the DNS server zone settings.

**🔌 Limitations**

You can create up to 16 DNS zones.

**🔌 Limitations**

You can create up to 256 resource records for each zone.

# Routing

## Menu Path: Routing

The Routing settings area lets you configure settings related to how your device routes network traffic.

This settings area includes these sections:

- Unicast Route
- Multicast Route
- Broadcast Forwarding

## Routing - User Privileges

Privileges to Routing settings are granted to the different authority levels as follows.

Refer to [System > Account Management > User Accounts](#) for more information on user accounts.

| Settings                          | Admin | Supervisor | User |
|-----------------------------------|-------|------------|------|
| <b>Unicast Routing</b>            |       |            |      |
| <b>Static Routes</b>              | R/W   | R/W        | R    |
| <b>RIP</b>                        | R/W   | R/W        | R    |
| <b>OSPF</b>                       | R/W   | R/W        | R    |
| <b>Routing Table</b>              | R     | R          | R    |
| <b>Multicast Route</b>            |       |            |      |
| <b>Multicast Route Settings</b>   | R/W   | R/W        | R    |
| <b>Static Multicast Route</b>     | R/W   | R/W        | R    |
| <b>Multicast Forwarding Table</b> | R     | R          | R    |
| <b>Broadcast Forwarding</b>       | R/W   | R/W        | R    |

# Unicast Route

## Menu Path: Routing > Unicast Route

This section lets you manage unicast routes for your device.

This section includes these pages:

- Static Routes
- RIP
- OSPF
- Routing Table

## Static Routes

### Menu Path: Routing > Unicast Route > Static Routes

This page lets you manage static routes for your device, which allows you to specify the next hop (or router) that the device will forward data to for a specific subnet. Static routes will be added to the routing table and stored on the device.

#### Limitations

You can create up to 512 static routes.

## Static Route List

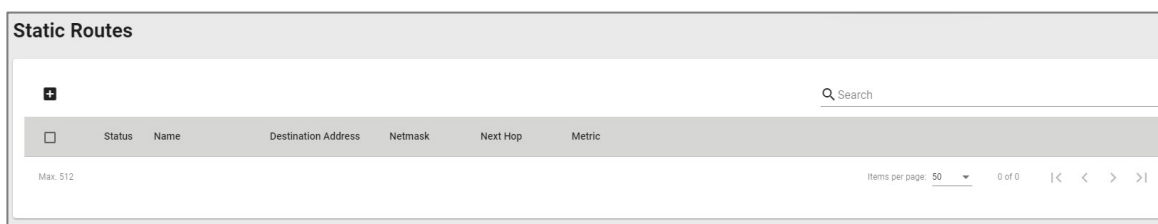

| Status | Name | Destination Address | Netmask | Next Hop | Metric |
|--------|------|---------------------|---------|----------|--------|
|--------|------|---------------------|---------|----------|--------|

| UI Setting    | Description                           |
|---------------|---------------------------------------|
| <b>Status</b> | Shows the status of the static route. |
| <b>Name</b>   | Shows the name of the static route.   |

| UI Setting                 | Description   |
|----------------------------|---|
| <b>Destination Address</b> | Shows the destination IP address for the static route.  |
| <b>Netmask</b>             | Shows the subnet mask for the destination IP address.   |
| <b>Next Hop</b>            | Shows the next router on the path to the destination IP address.  |
| <b>Metric</b>              | Shows the metric value used to determine the priority of the static route. Lower values have higher priority. |

## Edit a Static Route

### Menu Path: [Routing](#) > [Unicast Route](#) > [Static Routes](#)

Clicking the **Edit** (✎) icon for an entry on the **Routing > Unicast Route > Static Routes** page will open this dialog box. This dialog lets you edit an existing static route. Click **APPLY** to save your changes.

**Edit static route**

Status \*  
Disabled

Name \*  
test

Destination Address \* 4 / 10  
192.168.122.1

Subnet Mask \*  
24 (255.255.255.0)

Next Hop \*  
192.168.122.2

Metric \*  
1

1 - 254

CANCEL APPLY

| UI Setting                 | Description  | Valid Range              | Default Value |
|----------------------------|--|--------------------------|---------------|
| <b>Status</b>              | Enable or disable the static route.                      | Enabled / Disabled       | N/A           |
| <b>Name</b>                | Specify a name for the static route.                     | Max. 10 characters       | N/A           |
| <b>Destination Address</b> | Specify the destination IP address for the static route. | Valid IP address         | N/A           |
| <b>Subnet Mask</b>         | Specify the subnet mask for the destination IP address.  | Drop-down list of values | N/A           |

| UI Setting      | Description  | Valid Range      | Default Value |
|-----------------|--|------------------|---------------|
| <b>Next Hop</b> | Specify the next router on the path to the destination IP.   | Valid IP address | N/A           |
| <b>Metric</b>   | Specify the metric value to determine the priority of the static route. Lower values have higher priority. | 1 to 254         | N/A           |

## Create New Static Route

### Menu Path: Routing > Unicast Route > Static Routes

Clicking the **Add (+)** icon on the **Routing > Unicast Route > Static Routes** page will open this dialog box. This dialog lets you create a new static route. Click **CREATE** to save your changes and add the new account.

**Create new static route**

Status \*

Name \*  0 / 10

Destination Address \*  Subnet Mask \*

Next Hop \*  Metric \*  1 - 254

| UI Setting                 | Description  | Valid Range              | Default Value |
|----------------------------|--|--------------------------|---------------|
| <b>Status</b>              | Enable or disable the static route.                      | Enabled / Disabled       | N/A           |
| <b>Name</b>                | Specify a name for the static route.                     | Max. 10 characters       | N/A           |
| <b>Destination Address</b> | Specify the destination IP address for the static route. | Valid IP address         | N/A           |
| <b>Subnet Mask</b>         | Specify the subnet mask for the destination IP address.  | Drop-down list of values | N/A           |



| UI Setting      | Description  | Valid Range      | Default Value |
|-----------------|--|------------------|---------------|
| <b>Next Hop</b> | Specify the next router on the path to the destination IP.   | Valid IP address | N/A           |
| <b>Metric</b>   | Specify the metric value to determine the priority of the static route. Lower values have higher priority. | 1 to 254         | N/A           |

## Delete Static Route

### Menu Path: [Routing](#) > [Unicast Route](#) > [Static Routes](#)

You can delete entries by using the checkboxes to select the entries you want to delete, then clicking the **Delete** (  ) icon.

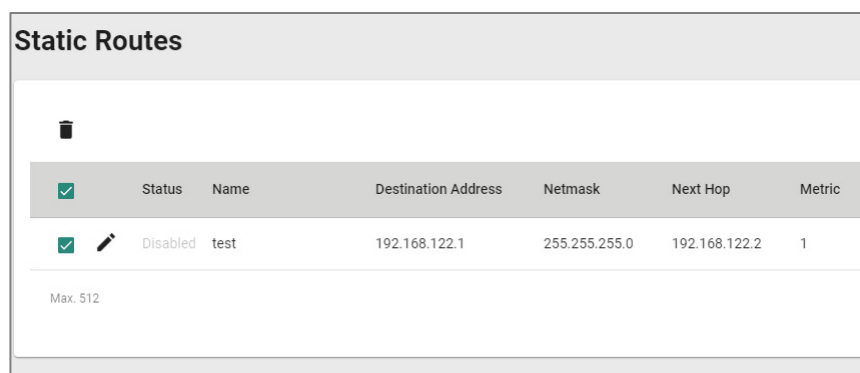

| Static Routes                       |          |      |                     |               |               |        |
|-------------------------------------|----------|------|---------------------|---------------|---------------|--------|
| <input checked="" type="checkbox"/> | Status   | Name | Destination Address | Netmask       | Next Hop      | Metric |
| <input checked="" type="checkbox"/> | Disabled | test | 192.168.122.1       | 255.255.255.0 | 192.168.122.2 | 1      |
| Max. 512                            |          |      |                     |               |               |        |

## RIP

### Menu Path: [Routing](#) > [Unicast Route](#) > [RIP](#)

This page lets you configure RIP (Routing Information Protocol), a distance-vector routing protocol that employs the hop count as a routing metric. RIP prevents routing from looping by implementing a limit on the number of hops allowed in a path from the source to a destination. Click **APPLY** to save your changes.

## RIP Settings

### RIP

Status \*  
Disabled

Version \*  
V2

Redistribute

**APPLY**

---

Search

| Status   | Interface | IP Address      | VLAN ID |
|----------|-----------|-----------------|---------|
| Disabled | WAN       | 10.123.13.33    | 2       |
| Disabled | LAN       | 192.168.127.254 | 1       |
| Disabled | Ian2      | 192.168.126.1   | 3       |

Max. 16 Items per page: 50 1 - 3 of 3 |< > >>

| UI Setting   | Description  | Valid Range               | Default Value |
|--|--|---------------------------|---------------|
| <b>Status</b>  | Enable or disable RIP protocol.  | Enabled / Disabled        | Disabled      |
| <b>Version</b>   | Set the RIP protocol version:<br><br><b>V1:</b> RIP V1 uses classful routing. This means that network addresses are assigned to specific classes, and the subnet mask is determined by the class of the network address.<br><br><b>V2:</b> RIP V2 uses classless routing. This means that network addresses can be assigned in a more flexible way, and the subnet mask can be specified independently of the network address class. | V1 / V2                   | V2            |
| <b>Redistribute</b>  | Set which rules to enable for RIP redistribution. You can enable multiple redistribution rules.<br><br><b>Connected:</b> Entries learned from directly connected interfaces will be re-distributed.<br><br><b>Static:</b> Entries set in a static route will be re-distributed.<br><br><b>OSPF:</b> Entries learned from the OSPF will be re-distributed.  | Connected / Static / OSPF | N/A           |
| <p> <b>Note</b></p> <p><i>Redistribute</i> in RIP refers to the process of importing routing information from other routing protocols into the RIP routing table, allowing for interconnectivity between different protocols and complex networks.</p> |  |                           |               |

## RIP Interface List



This list shows all of your device interfaces and the RIP settings applied to each one.

### Note

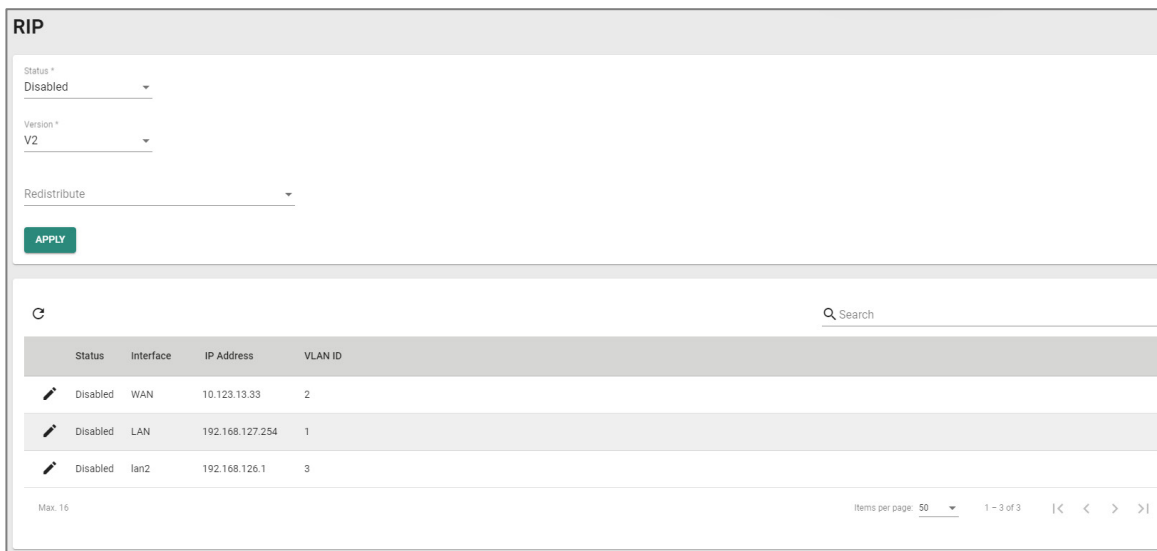
Interfaces and their settings can be configured in Network Configuration > Network Interfaces. VLAN IDs can be configured in Network Configuration > Layer 2 Switching > VLAN.



The screenshot shows the RIP configuration page. At the top, there are dropdown menus for Status (set to Disabled), Version (set to V2), and Redistribute. Below these is an APPLY button. A search bar is located above a table. The table has columns for Status, Interface, IP Address, and VLAN ID. It contains three rows of data. At the bottom right, there is a pagination control showing 'Items per page: 50' and '1 - 3 of 3'.

| Status   | Interface | IP Address      | VLAN ID |
|--|-----------|-----------------|---------|
|  Disabled  | WAN       | 10.123.13.33    | 2       |
|  Disabled | LAN       | 192.168.127.254 | 1       |
|  Disabled | Ian2      | 192.168.126.1   | 3       |

### UI Setting

### Description

#### Status

Shows whether RIP is enabled or disabled for the interface.

#### Interface (View Only)

Shows the name of the interface.

#### IP Address (View Only)

Shows the IP address of the interface.

#### VLAN ID (View Only)

Shows the VLAN ID of the interface.

## Edit RIP

### Menu Path: Routing > Unicast Route > RIP

Clicking the **Edit** (✎) icon for an interface on the **Routing > Unicast Route > RIP** page will open this dialog box. This dialog lets you edit the RIP settings for the interface. Click **APPLY** to save your changes.

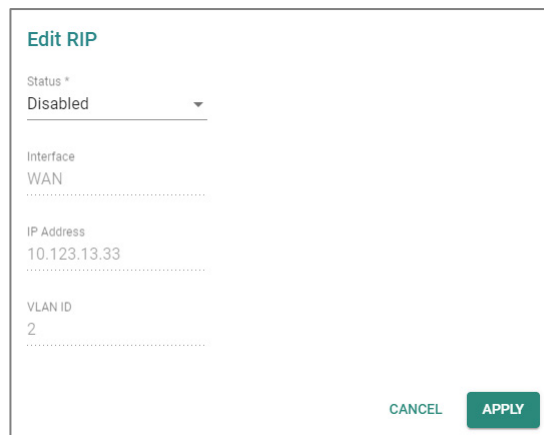

| UI Setting                       | Description                              | Valid Range          | Default Value |
|----------------------------------|--|----------------------|---------------|
| <b>Status</b>                    | Enable or disable RIP for the interface. | Enabled / Disabled   | Disabled      |
| <b>Interface</b><br>(View Only)  | Shows the name of the interface.         | Interface name       | N/A           |
| <b>IP Address</b><br>(View Only) | Shows the IP address of the interface.   | Interface IP address | N/A           |
| <b>VLAN ID</b><br>(View Only)    | Shows the VLAN ID of the interface.      | Interface VLAN ID    | N/A           |

## OSPF

### Menu Path: Routing > Unicast Route > OSPF

This section lets you configure OSPF (Open Shortest Path First) routing for your device.

This section includes these pages:

- OSPF Settings
- OSPF Status

## OSPF Settings

**Menu Path: Routing > Unicast Route > OSPF > OSPF Settings**

This page lets you configure OSPF settings for your device.

This page includes these tabs:

- General
- Area
- Interface
- Aggregation
- Virtual Link

### OSPF Settings - General

**Menu Path: Routing > Unicast Route > OSPF > OSPF Settings - General**

This page lets you adjust the basic settings for OSPF. Click APPLY to save your changes.

OSPF Settings

General Area Interface Aggregation Virtual Link

OSPF Settings \*  
Disabled

Router ID \*  
0.0.0.0

Current Router ID  
0.0.0.0

Redistribute

APPLY

| UI Setting           | Description                             | Valid Range        | Default Value |
|----------------------|---|--------------------|---------------|
| <b>OSPF Settings</b> | Enable or disable OSPF for your device. | Enabled / Disabled | Disabled      |

| UI Setting                           | Description   | Valid Range              | Default Value |
|--------------------------------------|---|--------------------------|---------------|
| <b>Router ID</b>                     | Specify the Router ID of your Moxa router.<br><br><div style="background-color: #f0f0f0; padding: 5px;"> <p><b>Note</b></p> <p>The router ID, which must be established for every OSPF instance, should be written in the dot-decimal format of an IP address (e.g., 1.2.3.4) and does not need to be part of any routable subnet on the network, since it is an IP address.</p> </div>   | Router ID                | 0.0.0.0       |
| <b>Current Router ID (View-only)</b> | Specify the current Router ID of your Moxa router.<br><br><div style="background-color: #f0f0f0; padding: 5px;"> <p><b>Note</b></p> <p>When the Router ID is set to 0.0.0.0, the Current Router ID will automatically use the highest interface IP address.</p> </div>  | Current Router ID        | 0.0.0.0       |
| <b>Redistribute</b>                  | Specify the OSPF redistribution method:<br><br><b>Connected:</b> Entries learned from the directly connected interfaces will be redistributed.<br><br><b>Static:</b> Entries set in a static route will be redistributed.<br><br><b>RIP:</b> Entries learned from RIP will be redistributed.<br><br><div style="background-color: #f0f0f0; padding: 5px;"> <p><b>Note</b></p> <p><i>Redistributing</i> in OSPF refers to the process of importing routing information from other routing protocols—such as RIP, EIGRP, etc.—into the OSPF routing table.</p> </div> | Connected / Static / RIP | N/A           |

## OSPF Settings - Area

### Menu Path: [Routing](#) > [Unicast Route](#) > [OSPF](#) > [OSPF Settings - Area](#)

This page lets you define OSPF areas.

#### **Note**

Areas are used to divide a large network into smaller network areas. Each area maintains a separate link state database whose information may be summarized towards the rest of the network by the connecting router. Thus, the topology of an area is unknown outside of the area. This reduces the amount of routing traffic between parts of an autonomous system.

### 🔒 Limitations

You can create up to 5 OSPF areas.

## OSPF Area List

OSPF Settings

General Area Interface Aggregation Virtual Link

+ Search

| <input type="checkbox"/> | Area ID | Area Type | Metric |
|--------------------------|---------|-----------|--------|
|--------------------------|---------|-----------|--------|

Max. 5 Items per page: 50 0 of 0 |< < > >|

| UI Setting   | Description                                       |
|--|---|
| <b>Area ID</b>   | Shows the area's ID.                              |
| <b>Area Type</b>                                       | Shows the type of OSPF routing used for the area. |
| <b>Metric</b><br><b>(Only for Metric is Stub/NSSA)</b> | Shows the metric value/cost for OSPF in the area. |

## Edit Area

### Menu Path: Routing > Unicast Route > OSPF > OSPF Settings - Area

Clicking the **Edit** (✎) icon for an OSPF area on the **Insert > Path Here** page will open this dialog box. This dialog lets you modify an existing OSPF area. Click **APPLY** to save your changes.

Edit Area

Area ID \*  
0.0.0.0

Area Type \*  
Normal

CANCEL APPLY

| UI Setting                                | Description   | Valid Range          | Default Value |
|---|---|----------------------|---------------|
| <b>Area ID</b>                            | Specify an ID for this OSPF area.   | N/A                  | N/A           |
| <b>Area Type</b>                          | Specify the type of OSPF routing to use for this area:<br><b>Normal:</b> A normal (or standard) area is an OSPF area that allows both intra-area and inter-area routing.<br><b>Stub:</b> A stub area is an OSPF area that does not allow external routes to be imported into the area.<br><b>NSSA:</b> An NSSA (Not-So-Stubby Area) is a special type of OSPF area that allows external routing information to be imported into the area, but does not allow the area to propagate that information to other areas. | Normal / Stub / NSSA | Normal        |
| <b>Metric (if Metric is Stub or NSSA)</b> | Specify the metric value/cost to use for this area.<br><div style="background-color: #f0f0f0; padding: 5px; margin-top: 10px;"> <p><b>Note</b></p> <p>Metrics are used to calculate the shortest path for data to travel through the network, and are determined by assigning cost values to the interfaces connecting to each router. The lower the cost value, the more the path will be preferred.</p> </div>  | 1 to 65535           | 1             |

## Create Area

### Menu Path: Routing > Unicast Route > OSPF > OSPF Settings - Area

Clicking the **Add (+)** icon on the **Routing > Unicast Route > OSPF > OSPF Settings - Area** page will open this dialog box. This dialog lets you create a new OSPF area. Click **CREATE** to save your changes and add the new area.

**Create Area**

Area ID \*

Area Type \*

Normal ▼

CANCEL
CREATE



| UI Setting                                | Description   | Valid Range          | Default Value |
|---|---|----------------------|---------------|
| <b>Area ID</b>                            | Specify an ID for this OSPF area.   | N/A                  | N/A           |
| <b>Area Type</b>                          | Specify the type of OSPF routing to use for this area:<br><b>Normal:</b> A normal (or standard) area is an OSPF area that allows both intra-area and inter-area routing.<br><b>Stub:</b> A stub area is an OSPF area that does not allow external routes to be imported into the area.<br><b>NSSA:</b> An NSSA (Not-So-Stubby Area) is a special type of OSPF area that allows external routing information to be imported into the area, but does not allow the area to propagate that information to other areas. | Normal / Stub / NSSA | Normal        |
| <b>Metric (if Metric is Stub or NSSA)</b> | Specify the metric value/cost to use for this area.<br><div style="background-color: #f0f0f0; padding: 5px; margin-top: 10px;"> <p><b>Note</b></p> <p>Metrics are used to calculate the shortest path for data to travel through the network, and are determined by assigning cost values to the interfaces connecting to each router. The lower the cost value, the more the path will be preferred.</p> </div>  | 1 to 65535           | 1             |

## Delete Area

### Menu Path: Routing > Unicast Route > OSPF > OSPF Settings - Area

You can delete an OSPF area by using the checkboxes to select the entries you want to delete, then clicking the **Delete (🗑)** icon.

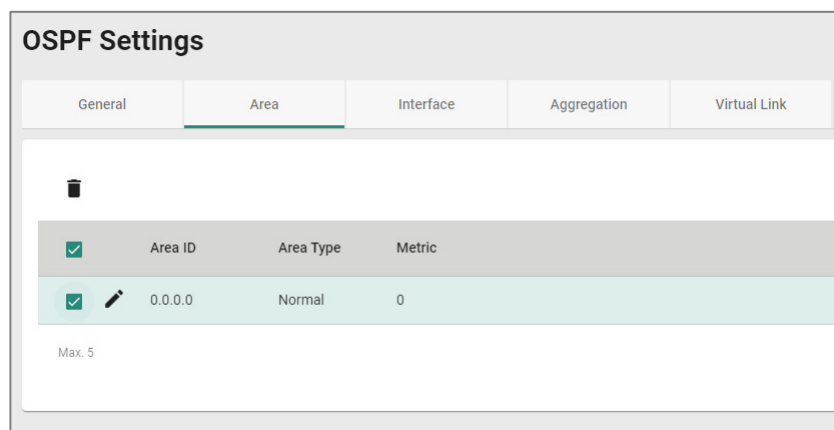

## OSPF Settings - Interface

### Menu Path: Routing > Unicast Route > OSPF > OSPF Settings - Interface

This page lets you configure the OSPF settings for each of your interfaces. To manage your interfaces, refer to [Network Configuration > Network Interfaces](#).

| OSPF Settings            |           |              |             |                       |                      |      |                    |           |            |        |            |  |
|--------------------------|-----------|--------------|-------------|-----------------------|----------------------|------|--------------------|-----------|------------|--------|------------|--|
| General                  | Area      | Interface    | Aggregation | Virtual Link          |                      |      |                    |           |            |        |            |  |
| + Search                 |           |              |             |                       |                      |      |                    |           |            |        |            |  |
| <input type="checkbox"/> | Interface | IP Address   | Area ID     | Hello Interval (sec.) | Dead Interval (sec.) | Role | Priority           | Auth Type | MD5 Key ID | Metric |            |  |
| <input type="checkbox"/> | WAN       | 10.123.13.33 | 0.0.0.0     | 10                    | 40                   | DR   | 1                  | MD5       | 12         | 1      |            |  |
| Max. 16                  |           |              |             |                       |                      |      | Items per page: 50 |           |            |        | 1 - 1 of 1 |  |

| UI Setting   | Description  |
|--|--|
| <b>Interface</b>                                       | Shows which interface this entry describes.                        |
| <b>IP Address</b>                                      | Shows the IP address of the interface.                             |
| <b>Area ID</b>   | Shows the OSPF area ID used for the interface.                     |
| <b>Hello Interval</b>                                  | Shows the hello message interval for the interface.                |
| <b>Dead Interval</b>                                   | Shows the dead interval for the interface.                         |
| <b>Role</b>  | Shows the role of the interface.                                   |
| <b>Priority</b>  | Shows the priority of the interface.                               |
| <b>Auth Type</b>                                       | Shows the authentication type used to authenticate OSPF neighbors. |
| <b>MD5 Key ID</b><br><b>(Only if Auth Type is MD5)</b> | Shows the MD5 key ID used to authenticate OSPF neighbors.          |
| <b>Metric</b>  | Shows the metric value/cost to OSPF.                               |

**Note**

Metrics are used to calculate the shortest path for data to travel through the network, and are determined by assigning cost values to the interfaces connecting to each router. The lower the cost value, the more the path will be preferred.

## OSPF Settings - Edit Interface

### Menu Path: Routing > Unicast Route > OSPF > OSPF Settings - Interface

Clicking the **Edit** (✎) icon for an entry on the **Insert > Path Here** page will open this dialog box. This dialog lets you edit existing OSPF settings for an interface. Click **APPLY** to save your changes.

The screenshot shows a dialog box titled "Edit Interface WAN". It contains the following fields and values:

- Interface: WAN
- Area ID: 0.0.0.0
- Priority: 1
- 0-255: (range indicator)
- Hello Interval: 10
- Dead Interval: 40
- 1-65535 sec: (range indicator)
- Auth Type: None
- Metric: 1
- 1-65535: (range indicator)

Buttons: CANCEL, APPLY

| UI Setting            | Description   | Valid Range            | Default Value |
|-----------------------|---|------------------------|---------------|
| <b>Interface</b>      | Specify which interface to assign to an OSPF area.  | Dropdown of interfaces | N/A           |
| <b>Area ID</b>        | Specify an OSPF area ID to assign to the interface.<br><br><div style="background-color: #f0f0f0; padding: 5px;"> <p><b>Note</b></p> <p>To manage OSPF areas, refer to <a href="#">Routing &gt; Unicast Route &gt; OSPF &gt; OSPF Settings - Area</a>.</p> </div>   | Dropdown of area IDs   | N/A           |
| <b>Priority</b>       | Specify the priority of the interface.  | 0 to 255               | 1             |
| <b>Hello Interval</b> | Set the hello message interval for the interface. The hello interval is the amount of time between sends of hello packets, which indicate that the device is still alive. The value of all hello intervals must be the same within a network.   | 1 to 65535 second(s)   | 10            |
| <b>Dead Interval</b>  | Set the dead interval for the interface. The dead interval is the amount of time a device will wait for a hello packet. If a hello packet is not received in this time, it will consider the other device to be dead or unavailable. By default, the dead interval is set to be four times the value of the hello interval. | 1 to 65535 second(s)   | 40            |

| UI Setting   | Description  | Valid Range         | Default Value |
|--|--|---------------------|---------------|
| <b>Auth Type</b>                                     | <p>Specify the authentication type to use when authenticating OSPF neighbors.</p> <p><b>None:</b> No authentication method will be used for neighbor authentication.</p> <p><b>Simple:</b> Neighbors will be authenticated using an auth key.</p> <p><b>MD5:</b> Neighbors will be authenticated more securely by using an auth key and an MD5 key ID.</p>   | None / Simple / MD5 | N/A           |
| <b>Auth Key (Only if Auth Type is Simple or MD5)</b> | <p>Specify the auth key to use for neighbor authentication.</p> <p><b>If the Auth Type is Simple,</b> the auth key will be a pure-text password.</p> <p><b>If the Auth Type is MD5,</b> the auth key will be an encrypted password.</p>  | 1 to 8 characters   | N/A           |
| <b>MD5 Key ID (Only if Auth Type is MD5)</b>         | <p>Specify the MD5 key ID to use for neighbor authentication.</p> <div style="background-color: #f0f0f0; padding: 5px; margin-top: 10px;"> <p><b>Note</b></p> <p>MD5 authentication method uses MD5 to calculate a hash value from the contents of the OSPF packet and the authentication key. This hash value is transmitted in the packet, along with a key ID.</p> </div>                             | 1 to 255            | 1             |
| <b>Metric</b>  | <p>Specify the metric value/cost for OSPF.</p> <div style="background-color: #f0f0f0; padding: 5px; margin-top: 10px;"> <p><b>Note</b></p> <p>Metrics are used to calculate the shortest path for data to travel through the network, and are determined by assigning cost values to the interfaces connecting to each router. The lower the cost value, the more the path will be preferred.</p> </div> | 1 to 65535          | 1             |

## OSPF Settings - Create Interface

**Menu Path:** Routing > Unicast Route > OSPF > OSPF Settings - Interface

Clicking the **Add (+)** icon on the **Insert > Path Here** page will open this dialog box. This dialog lets you select an interface and configure OSPF settings for it. Click **CREATE** to save your changes and add the new entry.

**Note**

You cannot create new interfaces in this dialog; you can only select existing interfaces. To create a new interface, refer to Network Configuration > Network Interfaces.

### Create Interface

Interface \* ▼

---

Area ID \* ▼

---

Priority \*

1

---

0 - 255

Hello Interval \* Dead Interval \*

10 40

---

1 - 65535 sec. 1 - 65535 sec.

Auth Type \*

None ▼

---

Metric \*



1

---

1 - 65535

CANCEL
CREATE

| UI Setting   | Description   | Valid Range            | Default Value |
|--|---|------------------------|---------------|
| <b>Interface</b>   | Specify which interface to assign to an OSPF area.  | Dropdown of interfaces | N/A           |
| <b>Area ID</b>   | Specify an OSPF area ID to assign to the interface.   | Dropdown of area IDs   | N/A           |
| <div style="background-color: #f0f0f0; padding: 5px; border: 1px solid #ccc;"> <p><b>Note</b></p> <p>To manage OSPF areas, refer to <a href="#">Routing &gt; Unicast Route &gt; OSPF &gt; OSPF Settings - Area</a>.</p> </div> |   |                        |               |
| <b>Priority</b>  | Specify the priority of the interface.  | 0 to 255               | 1             |
| <b>Hello Interval</b>  | Set the hello message interval for the interface. The hello interval is the amount of time between sends of hello packets, which indicate that the device is still alive. The value of all hello intervals must be the same within a network. | 1 to 65535 second(s)   | 10            |

| UI Setting   | Description   | Valid Range          | Default Value |
|--|---|----------------------|---------------|
| <b>Dead Interval</b>                                 | Set the dead interval for the interface. The dead interval is the amount of time a device will wait for a hello packet. If a hello packet is not received in this time, it will consider the other device to be dead or unavailable. By default, the dead interval is set to be four times the value of the hello interval.   | 1 to 65535 second(s) | 40            |
| <b>Auth Type</b>                                     | Specify the authentication type to use when authenticating OSPF neighbors.<br><b>None:</b> No authentication method will be used for neighbor authentication.<br><b>Simple:</b> Neighbors will be authenticated using an auth key.<br><b>MD5:</b> Neighbors will be authenticated more securely by using an auth key and an MD5 key ID.   | None / Simple / MD5  | N/A           |
| <b>Auth Key (Only if Auth Type is Simple or MD5)</b> | Specify the auth key to use for neighbor authentication.<br><b>If the Auth Type is Simple,</b> the auth key will be a pure-text password.<br><b>If the Auth Type is MD5,</b> the auth key will be an encrypted password.  | 1 to 8 characters    | N/A           |
| <b>MD5 Key ID (Only if Auth Type is MD5)</b>         | Specify the MD5 key ID to use for neighbor authentication.<br><br> <b>Note</b><br>MD5 authentication method uses MD5 to calculate a hash value from the contents of the OSPF packet and the authentication key. This hash value is transmitted in the packet, along with a key ID.                             | 1 to 255             | 1             |
| <b>Metric</b>  | Specify the metric value/cost for OSPF.<br><br> <b>Note</b><br>Metrics are used to calculate the shortest path for data to travel through the network, and are determined by assigning cost values to the interfaces connecting to each router. The lower the cost value, the more the path will be preferred. | 1 to 65535           | 1             |

## OSPF Settings - Delete Interface

### Menu Path: [Routing](#) > [Unicast Route](#) > [OSPF](#) > [OSPF Settings - Interface](#)

You can delete an entry by using the checkboxes to select the entries you want to delete, then clicking the **Delete** (  ) icon.

**Note**

Please note that this will delete the OSPF settings for the interface, but it will not delete the interface itself.

| Interface | IP Address   | Area ID | Hello Interval (sec.) | Dead Interval (sec.) | Role    | Priority | Auth Type | Auth Key | MD5 Key ID | Metric |
|-----------|--------------|---------|-----------------------|----------------------|---------|----------|-----------|----------|------------|--------|
| WAN       | 10.123.13.33 | 0.0.0.0 | 10                    | 40                   | Unknown | 1        | None      |          | 1          | 1      |

### OSPF Settings - Aggregation

**Menu Path: Routing > Unicast Route > OSPF > OSPF Settings - Aggregation**

This page lets you aggregate different OSPF areas into a single routing table entry.

**Limitations**

You can create up to 5 OSPF aggregations.

| Area ID | IP Address | Subnet Mask |
|---------|------------|-------------|
|---------|------------|-------------|

| UI Setting        | Description                       |
|-------------------|-----------------------------------|
| <b>Area ID</b>    | Shows the area ID.                |
| <b>IP Address</b> | Shows the IP address of the area. |

| UI Setting         | Description                    |
|--------------------|--------------------------------|
| <b>Subnet Mask</b> | Shows the network subnet mask. |

## Edit an Aggregation

### Menu Path: Routing > Unicast Route > OSPF > OSPF Settings - Aggregation

Clicking the **Edit** (✎) icon for an entry on the **Routing > Unicast Route > OSPF > OSPF Settings - Aggregation** page will open this dialog box. This dialog lets you modify an existing aggregation. Click **APPLY** to save your changes.

| UI Setting         | Description  | Valid Range                   | Default Value |
|--------------------|--|-------------------------------|---------------|
| <b>Area ID</b>     | Select the area ID that you want to use for the aggregation. | Dropdown list of area IDs     | N/A           |
| <b>IP Address</b>  | Specify the IP address to use for the area.                  | Valid IP address              | N/A           |
| <b>Subnet Mask</b> | Select the network subnet mask to use for the area.          | Dropdown list of subnet masks | N/A           |

## Create an Aggregation

### Menu Path: Routing > Unicast Route > OSPF > OSPF Settings - Aggregation

Clicking the **Add** (+) icon on the **Routing > Unicast Route > OSPF > OSPF Settings - Aggregation** page will open this dialog box. This dialog lets you create an OSPF aggregation. Click **CREATE** to save your changes and add the new aggregation.



### Create Aggregation

Area ID \*
▼

IP Address \*
Subnet Mask \*
▼

CANCEL
CREATE

| UI Setting         | Description  | Valid Range                   | Default Value |
|--------------------|--|-------------------------------|---------------|
| <b>Area ID</b>     | Select the area ID that you want to use for the aggregation. | Dropdown list of area IDs     | N/A           |
| <b>IP Address</b>  | Specify the IP address to use for the area.                  | Valid IP address              | N/A           |
| <b>Subnet Mask</b> | Select the network subnet mask to use for the area.          | Dropdown list of subnet masks | N/A           |

## Delete an Aggregation

**Menu Path: Routing > Unicast Route > OSPF > OSPF Settings - Aggregation**

You can delete an entry by using the checkboxes to select the entries you want to delete, then clicking the **Delete (🗑)** icon.

### OSPF Settings

General
Area
Interface
Aggregation
Virtual Link

🗑

|                                     | Area ID | IP Address   | Subnet Mask     |
|-------------------------------------|---------|--------------|-----------------|
| <input checked="" type="checkbox"/> | 0.0.0.0 | 192.167.12.1 | 255.255.255.254 |

Max. 5

## Virtual Link

### Menu Path: Routing > Unicast Route > OSPF > OSPF Settings - Virtual Link

This page lets you configure virtual links, which can be used to connect areas in an OSPF autonomous system when physical connection to the backbone area is not possible.

#### Limitations

You can create up to 5 OSPF virtual links.

## Virtual Link List

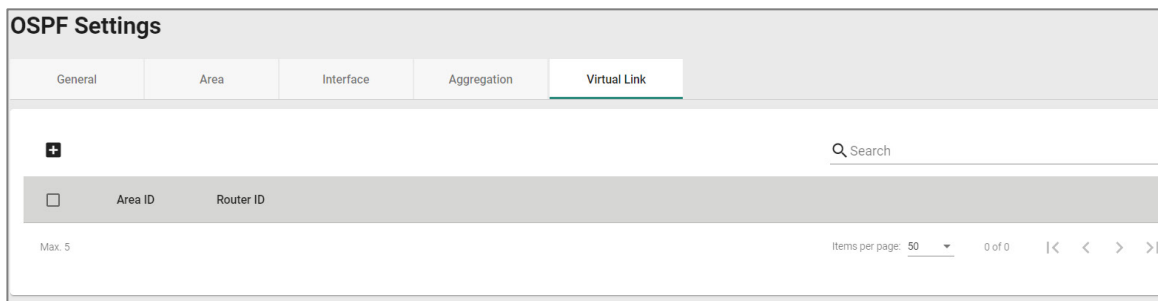

| UI Setting       | Description                               |
|------------------|---|
| <b>Area ID</b>   | Shows the area ID for the virtual link.   |
| <b>Router ID</b> | Shows the router ID for the virtual link. |

## Edit Virtual Link

### Menu Path: Routing > Unicast Route > OSPF > OSPF Settings - Virtual Link

Clicking the **Edit** (✎) icon for an entry on the **Insert > Path Here** page will open this dialog box. This dialog lets you modify an existing virtual link. Click **APPLY** to save your changes.

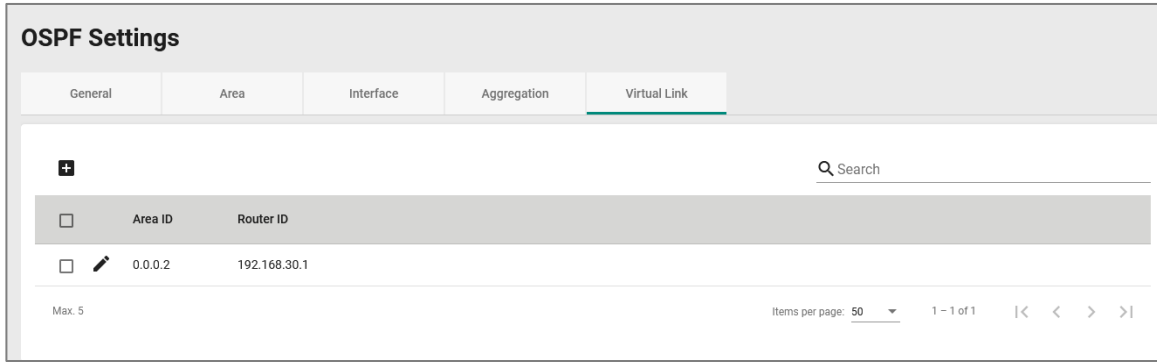

| UI Setting       | Description                                  | Valid Range               | Default Value |
|------------------|--|---------------------------|---------------|
| <b>Area ID</b>   | Select the area to use for the virtual link. | Dropdown list of area IDs | N/A           |
| <b>Router ID</b> | Specify the router ID for the virtual link.  | Valid router ID           | N/A           |

**Note**

To establish a virtual link in OSPF, you must input the corresponding router ID obtained from the Area Border Router (ABR) configuration. For Moxa routers, the router ID can be found in **Routing > Unicast Route > OSPF > OSPF Settings - General**.

## Create a Virtual Link

**Menu Path: Routing > Unicast Route > OSPF > OSPF Settings - Virtual Link**

Clicking the **Add (+)** icon on the **Insert > Path Here** page will open this dialog box. This dialog lets you create an OSPF virtual link. Click **CREATE** to save your changes and add the entry.

**Create Virtual Link**

Area ID \*

Router ID \*

| UI Setting       | Description  | Valid Range               | Default Value |
|------------------|--|---------------------------|---------------|
| <b>Area ID</b>   | Select the area to use for the virtual link.   | Dropdown list of area IDs | N/A           |
| <b>Router ID</b> | Specify the router ID for the virtual link.<br><br><div style="background-color: #f0f0f0; padding: 5px;"> <p><b>Note</b></p> <p>To establish a virtual link in OSPF, you must input the corresponding router ID obtained from the Area Border Router (ABR) configuration. For Moxa routers, the router ID can be found in <b>Routing &gt; Unicast Route &gt; OSPF &gt; OSPF Settings - General</b>.</p> </div> | Valid router ID           | N/A           |

## Delete Virtual Link

**Menu Path: Routing > Unicast Route > OSPF > OSPF Settings - Virtual Link**

You can delete an entry by using the checkboxes to select the entries you want to delete, then clicking the **Delete** (🗑️) icon.

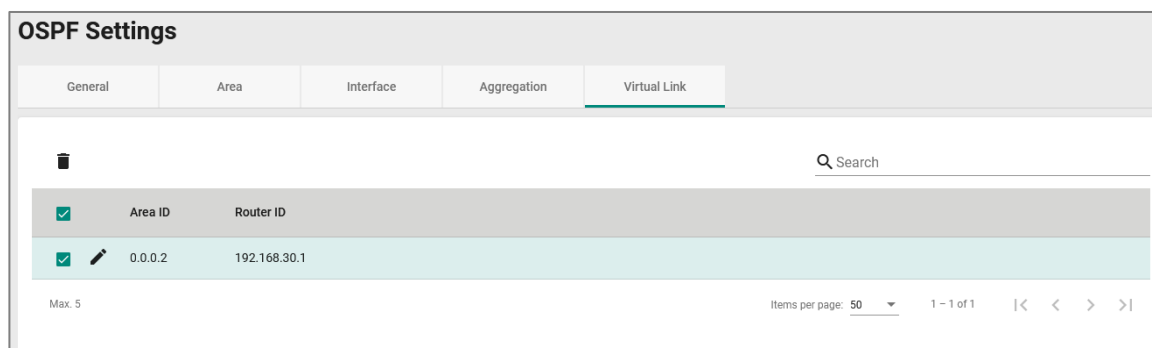

## OSPF Status

**Menu Path: Routing > Unicast Route > OSPF > OSPF Status**

This page lets you view the OSPF routing status of your device.

This page includes these tabs:

- Neighbor
- Database

## Neighbor

### Menu Path: Routing > Unicast Route > OSPF > OSPF Status - Neighbor

This page lets you see the status of OSPF neighbors. OSPF neighbors are devices that share their link-state information with other devices in the network.

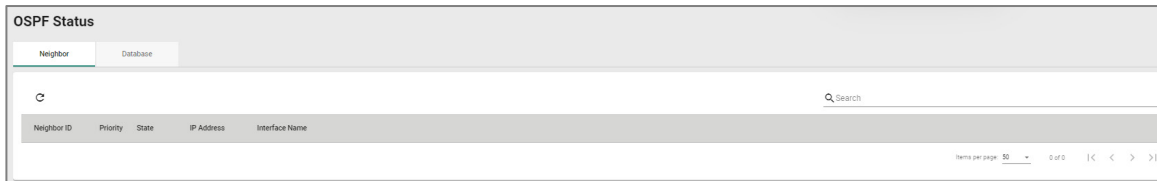

| UI Setting            | Description  |
|-----------------------|--|
| <b>Neighbor ID</b>    | Shows the unique identifier for the OSPF neighbor.   |
| <b>Priority</b>       | Shows priority value that the neighbor has assigned to itself.   |
| <b>State</b>          | Shows the current state of the OSPF neighbor relationship: <ul style="list-style-type: none"><li>• <b>Down:</b> The initial state before any OSPF communication has occurred between two routers.</li><li>• <b>Init:</b> The state where the local router has sent an OSPF Hello packet to a neighbor but has not yet received a response.</li><li>• <b>2-way:</b> The state where both routers have exchanged Hello packets and can become neighbors, but they have not yet established a bidirectional relationship.</li><li>• <b>Exstart:</b> The state where the routers determine which one will be the master and which one will be the slave during the database exchange process.</li><li>• <b>Exchange:</b> The state where the routers exchange link-state advertisement (LSA) headers and determine which LSAs need to be sent.</li><li>• <b>Loading:</b> The state where the routers exchange LSAs to synchronize their link-state databases.</li><li>• <b>Full:</b> The final state where the routers have a complete and accurate view of the network topology and are ready to forward traffic.</li></ul> |
| <b>IP Address</b>     | Shows the IP address of the neighbor router's interface used for OSPF communication.   |
| <b>Interface Name</b> | Shows the name of the local interface used for OSPF communication with the neighbor.   |

## Database

### Menu Path: Routing > Unicast Route > OSPF > OSPF Status - Database

This page lets you see the list of link-state advertisements (LSAs) that describe the network topology, which is used to calculate the shortest path to a destination.

| OSPF Status                      |      |          |            |           |       |  |
|----------------------------------|------|----------|------------|-----------|-------|--|
| Neighbor                         |      | Database |            |           |       |  |
| C                                |      |          |            |           |       |  |
| Search                           |      |          |            |           |       |  |
| LSA Type                         | Area | Link ID  | ADV Router | Age (sec) | Route |  |
| Items per page: 50 0 of 0 < > >> |      |          |            |           |       |  |

| UI Setting        | Description  | Valid Range | Default Value |
|-------------------|--|-------------|---------------|
| <b>LSA Type</b>   | Shows the type of the LSA, which describes the contents of the OSPF LSA packet.<br><br><b>Router LSA:</b> Describes the links attached to a router and is flooded within the same area as the router.<br><br><b>Network LSA:</b> Describes the routers attached to a multi-access network.<br><br><b>Summary LSA:</b> Advertises reachability information between OSPF areas.<br><br><b>AS External LSA:</b> Advertises routes to networks outside the OSPF domain.<br><br><b>NSSA External LSA:</b> Similar to the Type 5 LSA, but used in a Not-So-Stubby Area (NSSA) to advertise external routes.<br><br><b>Link-local LSA:</b> Used to advertise IPv6 link-local addresses and is flooded throughout the same link-local scope. | N/A         | N/A           |
| <b>Area</b>       | Identifies the area of the network to which the LSA belongs.   | N/A         | N/A           |
| <b>Link ID</b>    | Identifies the endpoint of the link described by the LSA.  | N/A         | N/A           |
| <b>ADV Router</b> | Identifies the router that the LSA originated from.  | N/A         | N/A           |
| <b>Route</b>      | OSPF uses the information in the LSAs to calculate the shortest path to a destination.   | N/A         | N/A           |

## Routing Table

**Menu Path: Routing > Unicast Route > Routing Table**

This page lets you see the current routing table for your device.

| Routing Table |           |                     |                 |           |        |  |
|---------------|-----------|---------------------|-----------------|-----------|--------|--|
| C             |           |                     |                 |           |        |  |
| Search        |           |                     |                 |           |        |  |
| Index         | Type      | Destination Address | Next Hop        | Interface | Metric |  |
| 1             | default   | 0.0.0.0/0           | 10.123.12.1     | WAN       | 1      |  |
| 2             | connected | 10.123.12.0/23      | 10.123.13.33    | WAN       | 1      |  |
| 3             | connected | 192.168.127.0/24    | 192.168.127.254 | LAN       | 1      |  |
| 1 - 3 of 3    |           |                     |                 |           |        |  |

| UI Setting                 | Description  |
|----------------------------|--|
| <b>Index</b>               | Shows the unique identifier for the routing table entry.                                       |
| <b>Type</b>                | Shows the source type of the route.  |
| <b>Destination Address</b> | Shows the address of the destination network for the route.                                    |
| <b>Next Hop</b>            | Shows the IP address of the next hop router or gateway that the packet should be forwarded to. |
| <b>Interface</b>           | Shows the outgoing interface that should be used to reach the destination network.             |
| <b>Metric</b>              | Shows the metric value/cost of the route to the destination network.                           |

 **Note**

Metrics are used to calculate the shortest path for data to travel through the network, and are determined by assigning cost values to the interfaces connecting to each router. The lower the cost value, the more the path will be preferred.

## Multicast Route

### Menu Path: [Routing](#) > [Multicast Route](#)

This section lets you configure multicast routing for your device.

This section includes these pages:

- Multicast Route Settings
- Static Multicast Route
- Multicast Forwarding Table

# Multicast Route Settings

**Menu Path:** Routing > Multicast Route > Multicast Route Settings

This page lets you enable or disable multicast routing. Click **APPLY** to save your changes.

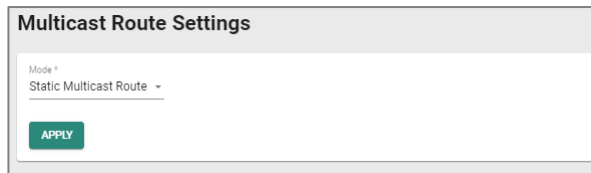

| UI Setting  | Description                          | Valid Range                       | Default Value |
|-------------|--------------------------------------|-----------------------------------|---------------|
| <b>Mode</b> | Enable or disable multicast routing. | Disabled / Static Multicast Route | Disabled      |

# Static Multicast Route

**Menu Path:** Routing > Multicast Route > Static Multicast Route

This page lets you manage multicast routes for your device.

**⚠ Limitations**  
 You can create up to 256 static multicast routes.

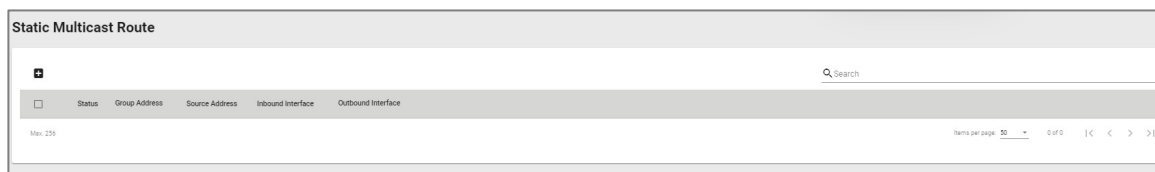

| UI Setting               | Description  |
|--------------------------|--|
| <b>Status</b>            | Shows whether the static multicast route is enabled or disabled. |
| <b>Group Address</b>     | Shows the group IP address for the route.                        |
| <b>Source Address</b>    | Shows the source address for the route.                          |
| <b>Inbound Interface</b> | Shows the inbound interface for the route.                       |



| UI Setting                | Description                                  |
|---------------------------|--|
| <b>Outbound Interface</b> | Shows the outbound interfaces for the route. |

## Edit Static Multicast Route

### Menu Path: Routing > Multicast Route > Static Multicast Route

Clicking the **Edit** (✎) icon for an entry on the **Routing > Multicast Route > Static Multicast Route** page will open this dialog box. This dialog lets you modify an existing static multicast route. Click **APPLY** to save your changes.

| UI Setting   | Description   | Valid Range                  | Default Value |
|--|---|------------------------------|---------------|
| <b>Status</b>  | Enable or disable this route.   | Enabled / Disabled           | Enabled       |
| <b>Group Address</b>   | Specify the group IP address for this route.  | N/A                          | N/A           |
| <b>Source Address Type</b>   | Specify the type of source address to use for this route.<br><b>Any:</b> Allow any IP to be the source address.<br><b>Specify Source:</b> Use the specified <b>Source Address</b> . | Any / Specify Source         | Any           |
| <b>Source Address</b><br>(Only if Source Address Type is Specify Source) | Specify the source IP address to use for this route.  | N/A                          | N/A           |
| <b>Inbound Interface</b>   | Select which interface broadcast packets will come from.  | Drop-down list of interfaces | N/A           |

| UI Setting                | Description  | Valid Range                  | Default Value |
|---------------------------|--|------------------------------|---------------|
| <b>Outbound Interface</b> | Select which interfaces the broadcast packets will be routed to. | Drop-down list of interfaces | N/A           |

## Create Static Multicast Route

### Menu Path: Routing > Multicast Route > Static Multicast Route

Clicking the **Add (+)** icon on the **Routing > Multicast Route > Static Multicast Route** page will open this dialog box. This dialog lets you add a new static multicast route. Click **CREATE** to save your changes and add the new account.

| UI Setting  | Description   | Valid Range                  | Default Value |
|---|---|------------------------------|---------------|
| <b>Status</b>   | Enable or disable this route.   | Enabled / Disabled           | Enabled       |
| <b>Group Address</b>  | Specify the group IP address for this route.  | N/A                          | N/A           |
| <b>Source Address Type</b>  | Specify the type of source address to use for this route.<br><b>Any:</b> Allow any IP to be the source address.<br><b>Specify Source:</b> Use the specified <b>Source Address</b> . | Any / Specify Source         | Any           |
| <b>Source Address<br/>(Only if Source Address Type is Specify Source)</b> | Specify the source IP address to use for this route.  | N/A                          | N/A           |
| <b>Inbound Interface</b>  | Select which interface broadcast packets will come from.  | Drop-down list of interfaces | N/A           |

| UI Setting                | Description  | Valid Range                  | Default Value |
|---------------------------|--|------------------------------|---------------|
| <b>Outbound Interface</b> | Select which interfaces the broadcast packets will be routed to. | Drop-down list of interfaces | N/A           |

## Delete Static Multicast Route

### Menu Path: Routing > Multicast Route > Static Multicast Route

You can delete an entry by using the checkboxes to select the entries you want to delete, then clicking the **Delete** (  ) icon.

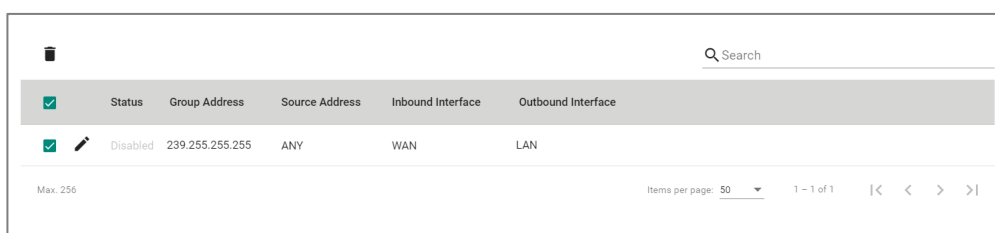

## Multicast Forwarding Table

### Menu Path: Routing > Multicast Route > Multicast Forwarding Table

This page lets you see the multicast forwarding table for your device.

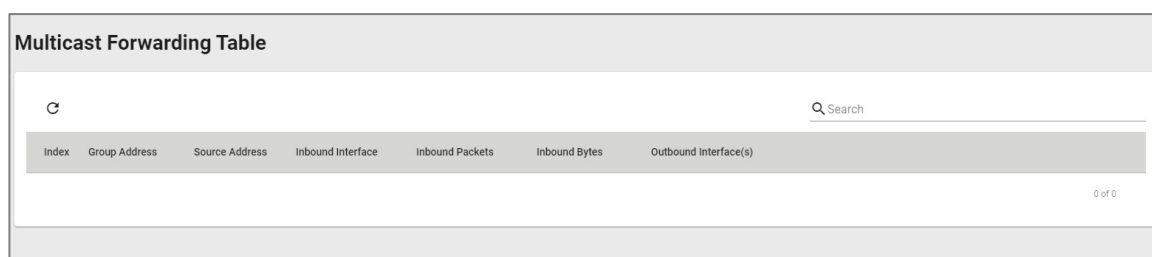

| UI Setting               | Description                               |
|--------------------------|---|
| <b>Index</b>             | Shows the index of the entry.             |
| <b>Group Address</b>     | Shows the group IP address of the entry.  |
| <b>Source Address</b>    | Shows the source address of the entry.    |
| <b>Inbound Interface</b> | Shows the inbound interface of the entry. |

| UI Setting                   | Description   |
|------------------------------|---|
| <b>Inbound Packets</b>       | Shows the number of inbound packets for the entry.              |
| <b>Inbound Bytes</b>         | Shows the size of the inbound payload (in bytes) for the entry. |
| <b>Outbound Interface(s)</b> | Shows the outbound interfaces of the entry.                     |

## Broadcast Forwarding

### Menu Path: [Routing](#) > [Broadcast Forwarding](#)

This page lets you set up broadcast forwarding. Broadcast forwarding enables users to specify the interface and UDP ports that broadcast packets will use to pass through the router, allowing devices to be queried on the network, such as Modbus devices.

#### Limitations

You can create up to 32 broadcast forwarding entries.

## Broadcast Forwarding Settings

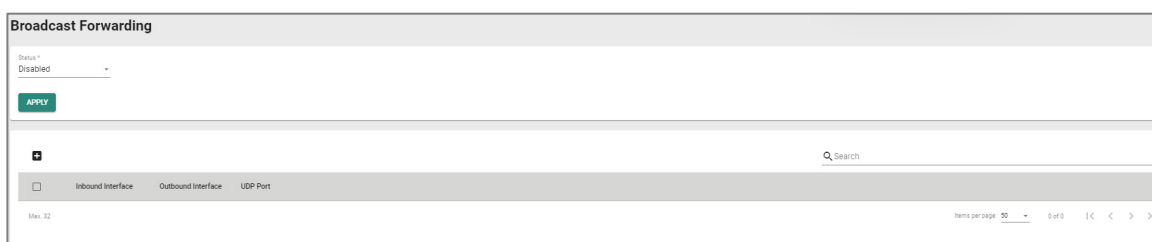

| UI Setting    | Description                             | Valid Range        | Default Value |
|---------------|---|--------------------|---------------|
| <b>Status</b> | Enable or disable broadcast forwarding. | Enabled / Disabled | Disabled      |

## Broadcast Forwarding List

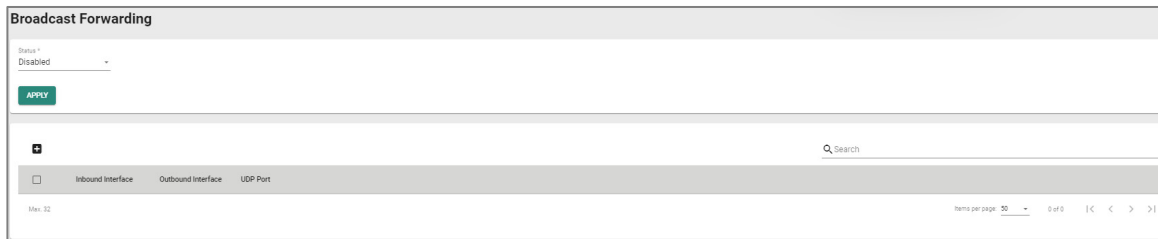

| UI Setting                | Description  |
|---------------------------|--|
| <b>Inbound Interface</b>  | Shows which interface broadcast packets will come from.              |
| <b>Outbound Interface</b> | Shows which interface broadcast packets will pass through.           |
| <b>UDP Port</b>           | Shows the UDP ports the device will listen to for broadcast packets. |

## Edit Broadcast Forwarding

**Menu Path:** Routing > Broadcast Forwarding

Clicking the **Edit** (✎) icon for an entry on the

**Unable to render include or excerpt-include. Could not retrieve page.**

page will open this dialog box. This dialog lets you modify an existing broadcast forwarding rule. Click **APPLY** to save your changes.

**Edit Broadcast Forwarding**

Inbound Interface \*

Outbound Interface \*

UDP Port \*

| UI Setting               | Description  | Valid Range                  | Default Value |
|--------------------------|--|------------------------------|---------------|
| <b>Inbound Interface</b> | Select which interface broadcast packets will come from. | Drop-down list of interfaces | N/A           |

| UI Setting                | Description  | Valid Range                                   | Default Value |
|---------------------------|--|---|---------------|
| <b>Outbound Interface</b> | Select which interface broadcast packets will pass through.  | Drop-down list of interfaces                  | N/A           |
| <b>UDP Port</b>           | Specify which UDP ports the device will listen to for broadcast packets. You can enter up to 8 ports, separated by commas. | 1 to 65535, up to 8 ports separated by commas | N/A           |

## Create Broadcast Forwarding

### Menu Path: Routing > Broadcast Forwarding



Clicking the **Add (+)** icon on the **Routing > Broadcast Forwarding** page will open this dialog box. This dialog lets you create a new broadcast forwarding rule. Click **CREATE** to save your changes and add the new rule.

| UI Setting                | Description  | Valid Range                                   | Default Value |
|---------------------------|--|---|---------------|
| <b>Inbound Interface</b>  | Select which interface broadcast packets will come from.   | Drop-down list of interfaces                  | N/A           |
| <b>Outbound Interface</b> | Select which interface broadcast packets will pass through.  | Drop-down list of interfaces                  | N/A           |
| <b>UDP Port</b>           | Specify which UDP ports the device will listen to for broadcast packets. You can enter up to 8 ports, separated by commas. | 1 to 65535, up to 8 ports separated by commas | N/A           |

## Delete Broadcast Forwarding

### Menu Path: Routing > Broadcast Forwarding

You can delete an entry by using the checkboxes to select the entries you want to delete, then clicking the **Delete (🗑)** icon.

|                                      | <input checked="" type="checkbox"/> | Inbound Interface | Outbound Interface | UDP Port |
|---|-------------------------------------|-------------------|--------------------|----------|
| <input checked="" type="checkbox"/>  |                                     | LAN               | WAN                | 1        |

Max. 32

# NAT

## Menu Path: NAT

This page allows you to manage your Network Address Translation (NAT) rules.

### Note

NAT currently supports the following ALG protocols: FTP, TFTP, SNMP.

### Limitations

You can create up to 512 NAT rules.

## NAT - User Privileges

Privileges to NAT settings are granted to the different authority levels as follows. Refer to [System > Account Management > User Accounts](#) for more information on user accounts.

| Settings | Admin | Supervisor | User |
|----------|-------|------------|------|
| NAT      | R/W   | R/W        | R    |

## NAT Rule List

| Status   | Description               | Index | Mode    | Protocol       | Incoming Interface | Src. IP:Port (Original Packet) | Det. IP:Port (Original Packet)    | Outgoing Interface | Src. IP:Port (Translated Packet) | Det. IP:Port (Translated Packet)      |
|----------|---------------------------|-------|---------|----------------|--------------------|--------------------------------|-----------------------------------|--------------------|----------------------------------|---------------------------------------|
| Enabled  | NAT_EDS-405A              | 1     | PAT     | TCP            | WAN                | Any:Any                        | Dynamic:405                       | Any                | Any:Any                          | 192.168.127.253:80                    |
| Enabled  | NAT_TN-4908_newUI_Port443 | 2     | PAT     | TCP            | WAN                | Any:Any                        | Dynamic:4908                      | Any                | Any:Any                          | 192.168.127.200:443                   |
| Enabled  | NAT_TN-5916_oldUI         | 3     | PAT     | TCP            | WAN                | Any:Any                        | Dynamic:5916                      | Any                | Any:Any                          | 192.168.127.201:80                    |
| Enabled  | NAT_OnCell3120_oldUI      | 4     | PAT     | TCP            | WAN                | Any:Any                        | Dynamic:3120                      | Any                | Any:Any                          | 192.168.127.202:443                   |
| Enabled  | NAT_MRC1002               | 5     | PAT     | TCP            | WAN                | Any:Any                        | Dynamic:1002                      | Any                | Any:Any                          | 192.168.127.203:80                    |
| Enabled  | NAT_EC-G102-EP            | 6     | PAT     | TCP            | WAN                | Any:Any                        | Dynamic:2002                      | Any                | Any:Any                          | 192.168.127.204:443                   |
| Enabled  | NAT_JEF-G910-IPN          | 7     | PAT     | TCP            | WAN                | Any:Any                        | Dynamic:9010                      | Any                | Any:Any                          | 192.168.127.205:443                   |
| Disabled | 1_to_1_NAT_range          | 8     | Advance | ICMP, TCP, UDP | WAN                | Any:Any                        | 10.123.13.200 - 10.123.13.203:Any | Any                | Any:Any                          | 192.168.127.100 - 192.168.127.103:Any |



| UI Setting                                  | Description   |
|---|---|
| <b>Status</b>                               | Shows whether the NAT rule is enabled or disabled.                        |
| <b>Description</b>                          | Shows the name of the NAT rule.   |
| <b>Index</b>                                | Shows the index of the NAT rule.  |
| <b>Mode</b>                                 | Shows the NAT mode used by the rule.                                      |
| <b>Protocol</b>                             | Shows the protocols included in the NAT rule.                             |
| <b>Incoming Interface</b>                   | Shows the incoming interface.   |
| <b>Src. IP:Port<br/>(Original Packet)</b>   | Shows the original source IP address and ports for incoming packets.      |
| <b>Dst. IP:Port<br/>(Original Packet)</b>   | Shows the original destination IP address and ports for incoming packets. |
| <b>Outgoing Interface</b>                   | Shows the outgoing interface.   |
| <b>Src. IP:Port<br/>(Translated Packet)</b> | Shows the translated source IP address and ports.                         |
| <b>Dst. IP:Port<br/>(Translated Packet)</b> | Shows the translated destination IP address and ports.                    |

## Edit NAT Rule

**Menu Path:** [Main > NAT](#)

Click on the pencil icon for the NAT rule that you want to edit.

|                          |          | Search                    |       |         |                |                    |                                |                                   |                    |                                  |  |
|--------------------------|----------|---------------------------|-------|---------|----------------|--------------------|--------------------------------|-----------------------------------|--------------------|----------------------------------|--|
| <input type="checkbox"/> | Status   | Description               | Index | Mode    | Protocol       | Incoming Interface | Src. IP:Port (Original Packet) | Dst. IP:Port (Original Packet)    | Outgoing Interface | Src. IP:Port (Translated Packet) |  |
| <input type="checkbox"/> | Enabled  | NAT_EDS-405A              | 1     | PAT     | TCP            | WAN                | Any:Any                        | Dynamic:405                       | Any                | Any:Any                          |  |
| <input type="checkbox"/> | Enabled  | NAT_TN-4908_newUI_Port443 | 2     | PAT     | TCP            | WAN                | Any:Any                        | Dynamic:4908                      | Any                | Any:Any                          |  |
| <input type="checkbox"/> | Enabled  | NAT_TN-5916_oldUI         | 3     | PAT     | TCP            | WAN                | Any:Any                        | Dynamic:5916                      | Any                | Any:Any                          |  |
| <input type="checkbox"/> | Enabled  | NAT_OnCell3120_oldUI      | 4     | PAT     | TCP            | WAN                | Any:Any                        | Dynamic:3120                      | Any                | Any:Any                          |  |
| <input type="checkbox"/> | Enabled  | NAT_MRC1002               | 5     | PAT     | TCP            | WAN                | Any:Any                        | Dynamic:1002                      | Any                | Any:Any                          |  |
| <input type="checkbox"/> | Enabled  | NAT_IJC-G102-BP           | 6     | PAT     | TCP            | WAN                | Any:Any                        | Dynamic:2002                      | Any                | Any:Any                          |  |
| <input type="checkbox"/> | Enabled  | NAT_IJF-G9010-VPN         | 7     | PAT     | TCP            | WAN                | Any:Any                        | Dynamic:9010                      | Any                | Any:Any                          |  |
| <input type="checkbox"/> | Disabled | 1_to_1_NAT_range          | 8     | Advance | ICMP, TCP, UDP | WAN                | Any:Any                        | 10.123.13.200 ~ 10.123.13.203:Any | Any                | Any:Any                          |  |

Max. 512 1 - 8 of 8

**APPLY**

For a complete list of settings, see [Create NAT Rule](#).

## Create Index

### Menu Path: NAT

Clicking the **Add (+)** icon on the **NAT** page will open this dialog box. This dialog lets you create a new NAT rule. Click **CREATE** to save your changes and add the new rule.

Available settings will change depending on what **Mode** is selected.

### Create Index - 1-to-1 NAT

If **1-to-1** is selected for the **Mode**, these settings will appear. 1-to-1 NAT maps one public IP address to one private IP address.

### Create Index 8

Enabled 0 / 128

---

Description

Index \*  
8

1 - 512

Mode  
1-to-1

Auto Create Source NAT  
Disabled !

NAT Loopback  
Disabled

Double NAT  
Disabled

VRRP Binding  
Disabled

**Original Packet (Condition)**

Incoming Interface  
LAN

Destination IP Mapping Type  
Single

Destination IP \*  
0.0.0.0

**Translated Packet (Action)**

Destination IP Mapping Type  
Single

Destination IP \*  
0.0.0.0

CANCEL APPLY

| UI Setting                    | Description   | Valid Range                     | Default Value |
|-------------------------------|---|---------------------------------|---------------|
| <b>Status</b>                 | Enable or disable this rule.  | Enabled / Disabled              | Enabled       |
| <b>Description</b>            | Specify a name for this rule.   | 1 to 128 characters             | N/A           |
| <b>Index</b>                  | Specify the index of this rule.   | 1 to 512                        | N/A           |
| <b>Mode</b>                   | Specify which NAT mode to use for this rule.<br><b>1-to-1:</b> 1-to-1 NAT maps one public IP address to one private IP address.<br><b>N-to-1:</b> N-to-1 NAT maps multiple private IP addresses to one public IP address.<br><b>PAT:</b> Port Address Translation (PAT) maps multiple private IP addresses to one public IP address using different port numbers.<br><b>Advance:</b> Allows you to set up an advanced NAT rule. | 1-to-1 / N-to-1 / PAT / Advance | 1-to-1        |
| <b>Auto Create Source NAT</b> | Enable or disable the Auto Create Source NAT feature. If this is disabled, 1-to-1 NAT will only perform DNAT.   | Enabled / Disabled              | Disabled      |
| <b>NAT Loopback</b>           | Enable or disable NAT Loopback. NAT loopback allows devices on a private network to access a server or service hosted on the same network using the public IP address of the network.   | Enabled / Disabled              | Disabled      |

| UI Setting          | Description  | Valid Range               | Default Value |
|---------------------|--|---------------------------|---------------|
| <b>Double NAT</b>   | Enable or disable Double NAT. Double NAT enables you to use 1-to-1 rules to facilitate two-way communication.  | Enabled / Disabled        | Disabled      |
| <b>VRRP Binding</b> | Select which VRRP index this rule should use, or disable VRRP binding. Virtual Router Redundancy Protocol (VRRP) Binding is a feature that allows the 1-to-1 NAT rule to be bound to a VRRP index. VRRP Binding is only supported in 1-to-1 NAT. If a VRRP index is selected, the 1-to-1 NAT rule is only valid when the system is the master. If no VRRP index is selected, the 1-to-1 NAT rule will be valid regardless of whether the system is the master or backup. | Disabled / VRRP Index No. | Disabled      |

### Original Packet (Condition)

| UI Setting   | Description   | Valid Range                  | Default Value |
|--|---|------------------------------|---------------|
| <b>Incoming Interface</b>  | Select the interface to use for this rule.  | Drop-down list of interfaces | LAN           |
| <b>Destination IP Mapping Type</b>   | Specify which destination IP addresses will be handled for incoming packets.<br><br><b>Single:</b> This rule will apply to a single destination IP for incoming packets.<br><br><b>Range:</b> This rule will apply to a range of destination IPs for incoming packets.<br><br><div style="border: 1px solid #ccc; background-color: #f9f9f9; padding: 5px; margin-top: 10px;">           With the 'Range' option, you have the capability to establish several 1-to-1 NAT mappings within a designated IP address range. It's essential to ensure that the 'Range' values in the Original Packet (Condition) align precisely with those in the Translated Packet (Action) for accurate Destination IP Mapping.         </div> | Single / Range               | Single        |
| <b>Destination IP (Only if Destination IP Mapping Type is Single)</b>        | Specify the destination IP this rule will apply to.   | Valid IP address             | 0.0.0.0       |
| <b>Destination IP: Start (Only for Destination IP Mapping Type is Range)</b> | Specify the start of the destination IP range this rule will apply to.  | Valid IP address             | 0.0.0.0       |

| UI Setting   | Description  | Valid Range      | Default Value |
|--|--|------------------|---------------|
| <b>Destination IP: End</b><br><br>(Only if Destination IP Mapping Type is Range) | Specify the end of the destination IP range this rule will apply to. | Valid IP address | 0.0.0.0       |

## Translated Packet (Action)

| UI Setting  | Description   | Valid Range      | Default Value |
|---|---|------------------|---------------|
| <b>Destination IP Mapping Type</b>  | Specify how to handle the destination IP address translation for the internal network.<br><br><b>Single:</b> Packets will be translated to a single IP address.<br><b>Range:</b> Packets will be translated to a range of IP addresses.<br><br><div style="border: 1px solid #ccc; padding: 5px; background-color: #f9f9f9;"> <p>With the 'Range' option, you have the capability to establish several 1-to-1 NAT mappings within a designated IP address range. It's essential to ensure that the 'Range' values in the Original Packet (Condition) align precisely with those in the Translated Packet (Action) for accurate Destination IP Mapping.</p> </div> | Single / Range   | Single        |
| <b>Destination IP</b><br>(Only if Destination IP Mapping Type is Single)        | Specify the destination IP to translate to on the internal network.   | Valid IP address | 0.0.0.0       |
| <b>Destination IP: Start</b><br>(Only for Destination IP Mapping Type is Range) | Specify the start of the destination IP range to translate to on the internal network.  | Valid IP address | 0.0.0.0       |
| <b>Destination IP: End</b><br>(Only if Destination IP Mapping Type is Range)    | Specify the end of the destination IP range to translate to on the internal network.  | Valid IP address | 0.0.0.0       |

## Create Index - N-to-1 NAT

If **N-to-1** is selected for the **Mode**, these settings will appear. N-to-1 NAT maps multiple private IP addresses to one public IP address.

| UI Setting         | Description   | Valid Range                     | Default Value |
|--------------------|---|---------------------------------|---------------|
| <b>Status</b>      | Enable or disable this rule.  | Enabled / Disabled              | Enabled       |
| <b>Description</b> | Specify a name for this rule.   | 1 to 128 characters             | N/A           |
| <b>Index</b>       | Specify the index of this rule.   | 1 to 512                        | N/A           |
| <b>Mode</b>        | Specify which NAT mode to use for this rule.<br><b>1-to-1:</b> 1-to-1 NAT maps one public IP address to one private IP address.<br><b>N-to-1:</b> N-to-1 NAT maps multiple private IP addresses to one public IP address.<br><b>PAT:</b> Port Address Translation (PAT) maps multiple private IP addresses to one public IP address using different port numbers.<br><b>Advance:</b> Allows you to set up an advanced NAT rule. | 1-to-1 / N-to-1 / PAT / Advance | 1-to-1        |

## Original Packet (Condition)

| UI Setting              | Description   | Valid Range      | Default Value |
|-------------------------|---|------------------|---------------|
| <b>Source IP: Start</b> | Specify the starting IP address of the source IP range this rule will apply to. | Valid IP address | 0.0.0.0       |
| <b>Source IP: End</b>   | Specify the starting IP address of the source IP range this rule will apply to. | Valid IP address | 0.0.0.0       |

## Translated Packet (Action)

| UI Setting                | Description  | Valid Range                  | Default Value |
|---------------------------|--|------------------------------|---------------|
| <b>Outgoing Interface</b> | Select the interface for the NAT rule.<br><br> <b>Note</b><br>The <b>Outgoing Interface</b> cannot be set to 'Any', as N-1 NAT requires a specific Outgoing Interface to be designated. | Drop-down list of interfaces | WAN           |

## Create Index - PAT

If **PAT** is selected for the **Mode**, these settings will appear. Port Address Translation (PAT) maps multiple private IP addresses to one public IP address using different port numbers.

### Create Index 9

Status \*  
Enabled

Description  
0 / 128

Index \*  
9

1 - 128

Mode  
PAT

Protocol

NAT Loopback  
Enabled

Double NAT  
Enabled

**Original Packet (Condition)**

Incoming Interface  
WAN

Destination Port \*  
0

1 - 65535

**Translated Packet (Action)**

Destination IP \*  
0.0.0.0

Destination Port \*  
0

1 - 65535

CANCEL APPLY

| UI Setting         | Description   | Valid Range                     | Default Value |
|--------------------|---|---------------------------------|---------------|
| <b>Status</b>      | Enable or disable this rule.  | Enabled / Disabled              | Enabled       |
| <b>Description</b> | Specify a name for this rule.   | 1 to 128 characters             | N/A           |
| <b>Index</b>       | Specify the index of this rule.   | 1 to 512                        | N/A           |
| <b>Mode</b>        | Specify which NAT mode to use for this rule.<br><b>1-to-1:</b> 1-to-1 NAT maps one public IP address to one private IP address.<br><b>N-to-1:</b> N-to-1 NAT maps multiple private IP addresses to one public IP address.<br><b>PAT:</b> Port Address Translation (PAT) maps multiple private IP addresses to one public IP address using different port numbers.<br><b>Advance:</b> Allows you to set up an advanced NAT rule. | 1-to-1 / N-to-1 / PAT / Advance | 1-to-1        |
| <b>Protocol</b>    | Select which protocols this rule will include.  | ICMP / TCP / UDP                | N/A           |



| UI Setting          | Description   | Valid Range        | Default Value |
|---------------------|---|--------------------|---------------|
| <b>NAT Loopback</b> | Enable or disable NAT Loopback. NAT loopback allows devices on a private network to access a server or service hosted on the same network using the public IP address of the network. | Enabled / Disabled | Disabled      |
| <b>Double NAT</b>   | Enable or disable Double NAT. Double NAT enables you to use 1-to-1 rules to facilitate two-way communication.   | Enabled / Disabled | Disabled      |

### Original Packet (Condition)

| UI Setting                | Description   | Valid Range                  | Default Value |
|---------------------------|---|------------------------------|---------------|
| <b>Incoming Interface</b> | Select the interface to use for this rule.            | Drop-down list of interfaces | LAN           |
| <b>Destination Port</b>   | Specify the destination port this rule will apply to. | 1 to 65535                   | Any           |

### Translated Packet (Action)

| UI Setting              | Description   | Valid Range      | Default Value |
|-------------------------|---|------------------|---------------|
| <b>Destination IP</b>   | Specify the destination IP to translate to on the internal network. | Valid IP address | 0.0.0.0       |
| <b>Destination Port</b> | Specify the port number to translate to on the internal network.    | 1 to 65535       | 0             |

### Create Index - Advance

If **Advance** is selected for the **Mode**, these settings will appear. This mode allows you to set up an advanced NAT rule, which can provide you with more flexibility for NAT configuration.

 **Note**

Please keep these in mind before setting up an advanced NAT rule:

- When using a Range, please ensure that the corresponding Range values are consistent.
- NAT Advance Mode only allows for a single range to be entered and does not support configuring multiple ranges in the same rule.
- Port settings can only be configured when the Protocol includes either TCP or UDP.
- If a Translated Destination IP is used, the Outgoing Interface cannot be configured.
- If the Translated Source IP is set to Dynamic, the Translated Source Port cannot be set.

## Create Index 8

Status \*

Enabled

Description

0 / 128

Index \*

8

1 - 512

Mode

Advance

Protocol

### Original Packet (Condition)

Incoming Interface

LAN

Source IP Mapping Type

Range

Source IP: Start \*

0.0.0.0

Source IP: End \*

0.0.0.0

Source Port Mapping Type

Range

Source Port: Start \*

0

Source Port: End \*

0

1 - 65535

1 - 65535

Destination IP Mapping Type

Range

Destination IP: Start \*

0.0.0.0

Destination IP: End \*

0.0.0.0



Destination Port Mapping Type

Range

Destination Port: Start \*

0

Destination Port: End \*

0

1 - 65535

1 - 65535

### Translated Packet (Action)

Outgoing Interface

Any

Source IP Mapping Type

Range

Source IP: Start \*

0.0.0.0

Source IP: End \*

0.0.0.0



| UI Setting         | Description   | Valid Range                     | Default Value |
|--------------------|---|---------------------------------|---------------|
| <b>Status</b>      | Enable or disable this rule.  | Enabled / Disabled              | Enabled       |
| <b>Description</b> | Specify a name for this rule.   | 1 to 128 characters             | N/A           |
| <b>Index</b>       | Specify the index of this rule.   | 1 to 512                        | N/A           |
| <b>Mode</b>        | Specify which NAT mode to use for this rule.<br><b>1-to-1:</b> 1-to-1 NAT maps one public IP address to one private IP address.<br><b>N-to-1:</b> N-to-1 NAT maps multiple private IP addresses to one public IP address.<br><b>PAT:</b> Port Address Translation (PAT) maps multiple private IP addresses to one public IP address using different port numbers.<br><b>Advance:</b> Allows you to set up an advanced NAT rule. | 1-to-1 / N-to-1 / PAT / Advance | 1-to-1        |
| <b>Protocol</b>    | Select which protocols this rule will include.  | ICMP / TCP / UDP                | N/A           |

### Original Packet (Condition)

| UI Setting  | Description   | Valid Range                   | Default Value |
|---|---|-------------------------------|---------------|
| <b>Incoming Interface</b>   | Select the interface to use for this rule.  | Drop-down list of interfaces  | LAN           |
| <b>Source IP Mapping Type</b>   | Specify which source IP addresses will be handled for incoming packets.<br><b>Any:</b> This rule will apply to all source IPs.<br><b>Single:</b> This rule will apply to a single source IP for incoming packets.<br><b>Range:</b> This rule will apply to a range of source IPs for incoming packets.<br><b>Subnet:</b> This rule will apply to a source IP and subnet mask. | Any / Single / Range / Subnet | Any           |
| <b>Source IP (Only if Source IP Mapping Type is Single or Subnet)</b> | Specify the source IP this rule will apply to.  | Valid IP address              | 0.0.0.0       |

| UI Setting   | Description  | Valid Range                   | Default Value         |
|--|--|-------------------------------|-----------------------|
| <b>Subnet Mask</b><br>(Only if Source IP Mapping Type is Subnet)         | Specify the subnet this rule will apply to.  | Valid subnet                  | 24<br>(255.255.255.0) |
| <b>Source IP: Start</b><br>(Only if Source IP Mapping Type is Range)     | Specify the start of the source IP range this rule will apply to.  | Valid IP address              | 0.0.0.0               |
| <b>Source IP: End</b><br>(Only if Source IP Mapping Type is Range)       | Specify the end of the source IP range this rule will apply to.  | Valid IP address              | 0.0.0.0               |
| <b>Source Port Mapping Type</b>  | Specify which source ports will be handled for incoming packets.<br><b>Any:</b> This rule will apply to all source ports.<br><b>Single:</b> This rule will apply to a single source port for incoming packets.<br><b>Range:</b> This rule will apply to a range of source ports for incoming packets.  | Any / Single / Range          | Any                   |
| <b>Source Port</b><br>(Only if Source Port Mapping Type is Single)       | Specify the source port this rule will apply to.   | 1 to 65535                    | N/A                   |
| <b>Source Port: Start</b><br>(Only if Source Port Mapping Type is Range) | Specify the start of the source port range this rule will apply to.  | 1 to 65535                    | N/A                   |
| <b>Source Port: End</b><br>(Only if Source Port Mapping Type is Range)   | Specify the end of the source port range this rule will apply to.  | 1 to 65535                    | N/A                   |
| <b>Destination IP Mapping Type</b>                                       | Specify which destination IP addresses will be handled for incoming packets.<br><b>Any:</b> This rule will apply to all destination IPs.<br><b>Single:</b> This rule will apply to a single destination IP for incoming packets.<br><b>Range:</b> This rule will apply to a range of destination IPs for incoming packets.<br><b>Subnet:</b> This rule will apply to a destination IP and subnet mask. | Any / Single / Range / Subnet | Any                   |

| UI Setting   | Description  | Valid Range          | Default Value         |
|--|--|----------------------|-----------------------|
| <b>Destination IP</b><br>(Only if Destination IP Mapping Type is Single or Subnet) | Specify the destination IP this rule will apply to.<br><br><div style="border: 1px solid #ccc; background-color: #f9f9f9; padding: 10px;"> <p><b>Note</b></p> <p>If your host is directly connected to the device or connected through a L2 switch, and the original destination IP is in the hosts' subnet but different from the incoming interface IP, you may add the original destination IP as a secondary IP for the incoming interface so the device can receive and use NAT for traffic from the host.</p> <p>Refer to <a href="#">Network Configuration &gt; Interface - Secondary IP</a> for more information.</p> </div> | Valid IP address     | 0.0.0.0               |
| <b>Subnet Mask</b><br>(Only if Destination IP Mapping Type is Subnet)              | Specify the subnet this rule will apply to.  | Valid subnet         | 24<br>(255.255.255.0) |
| <b>Destination IP: Start</b><br>(Only for Destination IP Mapping Type is Range)    | Specify the start of the destination IP range this rule will apply to.   | Valid IP address     | 0.0.0.0               |
| <b>Destination IP: End</b><br>(Only if Destination IP Mapping Type is Range)       | Specify the end of the destination IP range this rule will apply to.   | Valid IP address     | 0.0.0.0               |
| <b>Destination Port Mapping Type</b>   | Specify which destination ports will be handled for incoming packets.<br><br><b>Any:</b> This rule will apply to all destination ports.<br><br><b>Single:</b> This rule will apply to a single destination port for incoming packets.<br><br><b>Range:</b> This rule will apply to a range of destination ports for incoming packets.  | Any / Single / Range | Any                   |
| <b>Destination Port</b><br>(Only if Destination Port Mapping Type is Single)       | Specify the destination port this rule will apply to.  | 1 to 65535           | N/A                   |
| <b>Destination Port: Start</b><br>(Only if Destination Port Mapping Type is Range) | Specify the start of the destination port range this rule will apply to.   | 1 to 65535           | N/A                   |

| UI Setting  | Description  | Valid Range | Default Value |
|---|--|-------------|---------------|
| <b>Destination IP: End</b><br><b>(Only if Destination Port Mapping Type is Range)</b> | Specify the end of the destination port range this rule will apply to. | 1 to 65535  | N/A           |

## Translated Packet (Action)

| UI Setting  | Description   | Valid Range                             | Default Value         |
|---|---|---|-----------------------|
| <b>Outgoing Interface</b>   | Select the interface for the NAT rule.  | Drop-down list of interfaces            | Any                   |
| <b>Source IP Mapping Type</b>   | Specify how to handle source IP translation for the internal network.<br><b>Any:</b> This rule will translate to all source IPs.<br><b>Single:</b> This rule will translate to a single source IP.<br><b>Range:</b> This rule will translate to a range of source IPs.<br><b>Subnet:</b> This rule will translate to a source IP and subnet mask.<br><b>Dynamic:</b>  | Any / Single / Range / Subnet / Dynamic | Any                   |
| <b>Source IP</b><br><b>(Only if Source IP Mapping Type is Single or Subnet)</b> | Specify the source IP this rule will translate to.<br><br><div style="background-color: #f0f0f0; padding: 10px; border: 1px solid #ccc;"> <p><b>Note</b></p> <p>If <b>Source IP Mapping Type</b> is <b>Single</b>, if the destination host for the desired traffic is directly connected to the device or connected through a L2 switch, and the translated source IP is in the hosts' subnet but different from the outgoing interface IP, you may add the translated source IP as a secondary IP for the outgoing interface so the device can receive and use NAT for traffic going to the destination host.</p> <p>Refer to <a href="#">Network Configuration &gt; Interface - Secondary IP</a> for more information.</p> </div> | Valid IP address                        | 0.0.0.0               |
| <b>Subnet Mask</b><br><b>(Only if Source IP Mapping Type is Subnet)</b>         | Specify the subnet this rule will translate to.   | Valid subnet                            | 24<br>(255.255.255.0) |

| UI Setting  | Description  | Valid Range                   | Default Value |
|---|--|-------------------------------|---------------|
| <b>Source IP: Start</b><br><b>(Only if Source IP Mapping Type is Range)</b>     | Specify the start of the source IP range this rule will translate to.  | Valid IP address              | 0.0.0.0       |
| <b>Source IP: End</b><br><b>(Only if Source IP Mapping Type is Range)</b>       | Specify the end of the source IP range this rule will translate to.  | Valid IP address              | 0.0.0.0       |
| <b>Source Port Mapping Type</b>   | Specify how to handle source port translation for the internal network.<br><b>Any:</b> This rule will translate to all source ports.<br><b>Single:</b> This rule will translate to a single source port.<br><b>Range:</b> This rule will translate to a range of source ports.   | Any / Single / Range          | Any           |
| <b>Source Port</b><br><b>(Only if Source Port Mapping Type is Single)</b>       | Specify the source port this rule will translate to.   | 1 to 65535                    | N/A           |
| <b>Source Port: Start</b><br><b>(Only if Source Port Mapping Type is Range)</b> | Specify the start of the source port range this rule will translate to.  | 1 to 65535                    | N/A           |
| <b>Source Port: End</b><br><b>(Only if Source Port Mapping Type is Range)</b>   | Specify the end of the source port range this rule will translate to.  | 1 to 65535                    | N/A           |
| <b>Destination IP Mapping Type</b>  | Specify how to handle destination IP address translation for the internal network.<br><b>Any:</b> This rule will translate to all destination IPs.<br><b>Single:</b> This rule will translate to a single destination IP.<br><b>Range:</b> This rule will translate to a range of destination IPs.<br><b>Subnet:</b> This rule will translate to a destination IP and subnet mask. | Any / Single / Range / Subnet | Any           |



| UI Setting   | Description  | Valid Range          | Default Value         |
|--|--|----------------------|-----------------------|
| <b>Destination IP</b><br>(Only if Destination IP Mapping Type is Single or Subnet) | Specify the destination IP this rule will translate to.  | Valid IP address     | 0.0.0.0               |
| <b>Subnet Mask</b><br>(Only if Destination IP Mapping Type is Subnet)              | Specify the subnet this rule will translate to.  | Valid subnet         | 24<br>(255.255.255.0) |
| <b>Destination IP: Start</b><br>(Only for Destination IP Mapping Type is Range)    | Specify the start of the destination IP range this rule will translate to.   | Valid IP address     | 0.0.0.0               |
| <b>Destination IP: End</b><br>(Only if Destination IP Mapping Type is Range)       | Specify the end of the destination IP range this rule will translate to.   | Valid IP address     | 0.0.0.0               |
| <b>Destination Port Mapping Type</b>   | Specify how to handle destination port translation for the internal network.<br><b>Any:</b> This rule will apply to all destination ports.<br><b>Single:</b> This rule will apply to a single destination port for incoming packets.<br><b>Range:</b> This rule will apply to a range of destination ports for incoming packets. | Any / Single / Range | Any                   |
| <b>Destination Port</b><br>(Only if Destination Port Mapping Type is Single)       | Specify the destination port this rule will translate to.  | 1 to 65535           | N/A                   |
| <b>Destination Port: Start</b><br>(Only if Destination Port Mapping Type is Range) | Specify the start of the destination port range this rule will translate to.   | 1 to 65535           | N/A                   |

| UI Setting  | Description  | Valid Range | Default Value |
|---|--|-------------|---------------|
| <b>Destination Port: End</b><br><br><b>(Only if Destination Port Mapping Type is Range)</b> | Specify the end of the destination port range this rule will translate to. | 1 to 65535  | N/A           |

## Delete NAT Rule

**Menu Path: Main > NAT**

Select the NAT rules that you want to delete and click the trash can icon to delete.

| Status                              | Description               | Index | Mode    | Protocol       | Incoming Interface | Src. IP-Port (Original Packet) | Dst. IP-Port (Original Packet)    | Outgoing Interface | Src. IP-Port (Translated Packet) |
|-------------------------------------|---------------------------|-------|---------|----------------|--------------------|--------------------------------|-----------------------------------|--------------------|----------------------------------|
| <input checked="" type="checkbox"/> | NAT_EDS-405A              | 1     | PAT     | TCP            | WAN                | Any:Any                        | Dynamic:405                       | Any                | Any:Any                          |
| <input type="checkbox"/>            | NAT_TN-4908_newUI_Port443 | 2     | PAT     | TCP            | WAN                | Any:Any                        | Dynamic:4908                      | Any                | Any:Any                          |
| <input type="checkbox"/>            | NAT_TN-5916_oldUI         | 3     | PAT     | TCP            | WAN                | Any:Any                        | Dynamic:5916                      | Any                | Any:Any                          |
| <input type="checkbox"/>            | NAT_OnCell3120_oldUI      | 4     | PAT     | TCP            | WAN                | Any:Any                        | Dynamic:3120                      | Any                | Any:Any                          |
| <input type="checkbox"/>            | NAT_MRC1002               | 5     | PAT     | TCP            | WAN                | Any:Any                        | Dynamic:1002                      | Any                | Any:Any                          |
| <input type="checkbox"/>            | NAT_IEC-G102-BP           | 6     | PAT     | TCP            | WAN                | Any:Any                        | Dynamic:2002                      | Any                | Any:Any                          |
| <input type="checkbox"/>            | NAT_IEF-G9010-VPN         | 7     | PAT     | TCP            | WAN                | Any:Any                        | Dynamic:9010                      | Any                | Any:Any                          |
| <input type="checkbox"/>            | 1_to_1_NAT_range          | 8     | Advance | ICMP, TCP, UDP | WAN                | Any:Any                        | 10.123.13.200 ~ 10.123.13.203:Any | Any                | Any:Any                          |

Max. 512 1 - 8 of 8

**APPLY**

# Object Management

## Menu Path: Object Management

This page lets you use object-based firewall management to help protect your network on a granular level.

## Object Management - User Privileges

Privileges to Object Management settings are granted to the different authority levels as follows. Refer to [System > Account Management > User Accounts](#) for more information on user accounts.



| Settings          | Admin | Supervisor | User |
|-------------------|-------|------------|------|
| Object Management | R/W   | R/W        | R    |

You can create, modify, and edit the objects you need based on your security requirements. These objects are used when creating Layer 3-7 policies for the device's firewall.

In addition, objects allow for more efficient firewall rule management. A single object can be assigned to multiple rules and changes to the object will apply to all associated rules, removing the need to update individual policies one by one.

### Limitations

You can create up to 512 objects.

| <input type="checkbox"/> | Name   | Type                           | Details              | References |
|--------------------------|--|--------------------------------|----------------------|------------|
| <input type="checkbox"/> |  MOXA_Test  | IP Address and Subnet          | 10.0.0.1 - 10.0.0.10 | 0          |
| <input type="checkbox"/> |  MOXA_Test2 | Industrial Application Service | DNP3                 | 0          |
| <input type="checkbox"/> |  MOXA_Test3 | Industrial Application Service | Modbus               | 0          |

Max. 512

Items per page: 50 1 - 3 of 3

| UI Setting        | Description   |
|-------------------|---|
| <b>Name</b>       | Shows the name of the object.   |
| <b>Type</b>       | Shows the type of the object.   |
| <b>Details</b>    | Shows the settings for the object. These settings will vary depending on the object's <b>Type</b> . |
| <b>References</b> | Shows the number of times this object is referenced in firewall rules.                              |

## Edit Object

### Menu Path: Object Management

Clicking the **Edit (✎)** icon for an object on the **Object Management** page will open this dialog box. This dialog lets you edit an existing object. Click **APPLY** to save your changes.

Available settings will vary depending on which **Object Type** the object uses.

#### ✎ Note

When editing an object, you cannot change its Object Type.

## Edit Object - IP Address and Subnet

If **IP Address and Subnet** is selected for the **Object Type**, these settings will appear.

The screenshot shows the 'Edit Object' dialog box with the following fields and options:

- Name \***: A text input field containing 'test' with a character count '4 / 32'.
- Object Type**: A dropdown menu currently showing 'IP Address and Subnet'.
- IP Type \***: A dropdown menu currently showing 'Single IP'.
- IP Address \***: An empty text input field.
- At the bottom right, there are two buttons: 'CANCEL' and 'APPLY'.

| UI Setting   | Description   | Valid Range                    | Default Value         |
|--|---|--------------------------------|-----------------------|
| <b>Name</b>  | Specify a name for the object.  | 1 to 32 characters             | N/A                   |
| <b>Object Type<br/>(View-only)</b>                                 | Shows the type for the object. This setting cannot be changed when editing an object. | IP Address and Subnet          | IP Address and Subnet |
| <b>IP Type</b>   | Select the type of IP address to use for the object.                                  | Single IP / IP Range / Subnet  | N/A                   |
| <b>IP Address<br/>(If Single is selected for IP Type)</b>          | Specify the IP address to use for the object.   | Valid IP Address               | N/A                   |
| <b>IP Address: Start<br/>(If IP Range is selected for IP Type)</b> | Specify the start of the IP range to use for the object.                              | Valid IP Address               | N/A                   |
| <b>IP Address: End<br/>(If IP Range is selected for IP Type)</b>   | Specify the end of the IP range to use for the object.                                | Valid IP Address               | N/A                   |
| <b>Subnet<br/>(If Subnet is selected for IP Type)</b>              | Specify the IP address of the subnet to use for the object.                           | Valid IP Address               | N/A                   |
| <b>Subnet Mask<br/>(If Subnet is selected for IP Type)</b>         | Select the subnet mask to use for the object.   | Drop-down list of subnet masks | N/A                   |

## Edit Object - Network Service

If **Network Service** is selected for the **Object Type**, these settings will appear.

### Create Object

Name \* 0 / 32

Object Type  
Network Service

Select Network Service(s)

- >  Remote-Access
- >  Remote-Desktop
- >  Email
- >  File-Transfer
- >  Web-Access
- >  Network-Service
- >  Authentication
- >  VOIP-and-Streaming
- >  SQL-Server

CANCEL
CREATE

| UI Setting                         | Description   | Valid Range  | Default Value   |
|------------------------------------|---|--|-----------------|
| <b>Name</b>                        | Specify a name for the object.  | 1 to 32 characters   | N/A             |
| <b>Object Type<br/>(View-only)</b> | Shows the type for the object. This setting cannot be changed when editing an object.                                 | Network Service  | Network Service |
| <b>Select Network Service(s)</b>   | Select a category of network services, or individual services to use for the object. You can select multiple options. | Remote-Access / Remote-Desktop / Email / File-Transfer / Web-Access / Network-Service / Authentication / VOIP-and-Streaming / SQL-Server   | N/A             |
| <b>Remote-Access</b>               | This category includes protocols used for remote access to a device.  | WINS (TCP 1512; UDP 1512)<br>TELNET (TCP 23)<br>SSH (TCP 22)   | N/A             |
| <b>Remote-Desktop</b>              | This category includes protocols used by various remote desktop services.   | PC-Anywhere (TCP 5631; UDP 5632)<br>Chrome-Remote-Desktop (UDP 5222)<br>AnyDesk (TCP 6568, 7070; UDP 50001 - 50003)<br>Teamviewer (TCP 5938)<br>RDP (TCP 3389)<br>VNC (TCP 5900)<br>X-WINDOW (TCP 6000 - 6063) | N/A             |

| UI Setting                | Description   | Valid Range  | Default Value |
|---------------------------|---|--|---------------|
| <b>Email</b>              | This category includes protocols used for sending and receiving emails.       | IMAP (TCP 143)<br>IMAPS (TCP 993)<br>POP3 (TCP 110)<br>POP3S (TCP 995)<br>SMTP (TCP 25)<br>SMTPS (TCP 465)   | N/A           |
| <b>File-Transfer</b>      | This category includes protocols used for different methods of file transfer. | FTP (TCP 21)<br>FTPS (TCP 990)<br>SFTP (TCP 115; UDP 115)<br>TFTP (UDP 69)<br>NFS (TCP 111, 2049; UDP 111, 2049)<br>SAMBA (TCP 139)<br>AFS3 (TCP 7000 - 7009; UDP 7000 - 7009)<br>SMB (TCP 445)  | N/A           |
| <b>Web-Access</b>         | This category includes protocols used by web browsers.                        | HTTP (TCP 80)<br>HTTPS (TCP 443)   | N/A           |
| <b>Network-Service</b>    | This category includes protocols used by various network services.            | BGP (TCP 179)<br>DHCP (UDP 67)<br>DHCP6 (UDP 546)<br>DNS (TCP 53; UDP 53)<br>NTP (TCP 123; UDP 123)<br>ICMP-PING (ICMP Type Any Code Any)<br>OSPF (IP Protocol 89)<br>RIP (TCP 520)<br>SNMP (TCP 161 - 162; UDP 161 - 162)<br>SYSLOG (UDP 514) | N/A           |
| <b>Authentication</b>     | This category includes protocols used by authentication services.             | LDAP (TCP 389; UDP 389)<br>LDAPS (TCP 636; UDP 636)<br>RADIUS (UDP 1812 - 1813)<br>TACACS+ (TCP 49; UDP 49)  | N/A           |
| <b>VOIP-and-Streaming</b> | This category includes protocols used for VOIP calling and streaming video.   | SIP (TCP 5060; UDP 5060)<br>RSTP (TCP 554, 7070, 8554; UDP 554)  | N/A           |
| <b>SQL-Server</b>         | This category includes protocols used for SQL servers.                        | MS-SQL (TCP 1433 - 1434)<br>MYSQL (TCP 3306)   | N/A           |

## Edit Object - Industrial Application Service

If **Industrial Application Service** is selected for the **Object Type**, these settings will appear.

| UI Setting                                      | Description   | Valid Range   | Default Value                  |
|---|---|---|--------------------------------|
| <b>Name</b>                                     | Specify a name for the object.  | 1 to 32 characters  | N/A                            |
| <b>Object Type<br/>(View-only)</b>              | Shows the type for the object. This setting cannot be changed when editing an object.                                 | Industrial Application Service  | Industrial Application Service |
| <b>Select Industrial Application Service(s)</b> | Select a category of network services, or individual services to use for the object. You can select multiple options. | Modbus (TCP 502; UDP 502)<br>DNP3 (TCP 20000)<br>IEC-60870-5-104 (TCP 2404)<br>IEC-61850-MMS (TCP 102)<br>OPC-DA (TCP 135)<br>OPC-UA (TCP 4840; UDP 4840)<br>CIP-EtherNet/IP (TCP 44818; UDP 2222)<br>Siemens-Step7 (TCP 102)<br>Moxa-RealCOM (TCP 950 - 981)<br>Moxa-MXview-Request (TCP 161, 162, 443, 4000; UDP 4000, 40404) | N/A                            |

## Edit Object - User-defined Service

If **User-defined Service** is selected for the **Object Type**, these settings will appear.



| UI Setting   | Description   | Valid Range  | Default Value        |
|--|---|--|----------------------|
| <b>Name</b>  | Specify a name for the object.  | 1 to 32 characters                                     | N/A                  |
| <b>Object Type<br/>(View-only)</b>   | Shows the type for the object. This setting cannot be changed when editing an object.   | User-defined Service                                   | User-defined Service |
| <b>IP Protocol</b>   | Select the IP protocols to use for the object.  | TCP / UDP / TCP and UDP / ICMP Custom IP Protocol      | N/A                  |
| <b>Service Port Type<br/>(If TCP, UDP, or TCP and UDP is selected for IP Protocol)</b> | Select how to define ports for the object.<br><b>Any:</b> All ports will be included.<br><b>Single TCP and UDP Port:</b> Specify a single port to include.<br><b>TCP and UDP Port Range:</b> Specify a range of ports to include. | Any / Single TCP and UDP Port / TCP and UDP Port Range |                      |
| <b>Port<br/>(If Single TCP and UDP Port is selected for Service Port Type)</b>         | Specify a port to include.  | 1 to 65535   | N/A                  |
| <b>Port: Start<br/>(If TCP and UDP Port Range is selected for Service Port Type)</b>   | Specify the start of the port range to use for the object.  | 1 to 65535   | N/A                  |
| <b>Port: End<br/>(If TCP and UDP Port Range is selected for Service Port Type)</b>     | Specify the end of the port range to use for the object.  | 1 to 65535   | N/A                  |

| UI Setting   | Description   | Valid Range     | Default Value |
|--|---|-----------------|---------------|
| <b>ICMP Type (Decimal)</b><br><b>(If ICMP is selected for IP Protocol)</b>                 | Specify the ICMP type in decimal form to use for the object. Leave this blank to allow all ICMP types to be included. | Blank, 0 to 255 | N/A           |
| <b>ICMP Code (Decimal)</b><br><b>(If ICMP is selected for IP Protocol)</b>                 | Specify the ICMP code in decimal form to use for the object. Leave this blank to allow all ICMP codes to be included. | Blank, 0 to 255 | N/A           |
| <b>IP Protocol (Decimal)</b><br><b>(If Custom IP Protocol is selected for IP Protocol)</b> | Specify the IP protocol in decimal form to use for the object.  | 0 to 255        | N/A           |

## Create Object

### Menu Path: Object Management

Clicking the **Add (+)** icon on the **Object Management** page will open this dialog box. This dialog lets you create a new object. Click **CREATE** to save your changes and add the new object.

The available settings will vary depending on which **Object Type** is selected.

**Create Object**

Name \*  
 0 / 32

Object Type \*

CANCEL CREATE

### Create Object - IP Address and Subnet

If **IP Address and Subnet** is selected for the **Object Type**, these settings will appear.

### Create Object

Name \*  
  
9 / 32

Object Type \*

IP Type \*

CANCEL
CREATE

| UI Setting   | Description  | Valid Range   | Default Value |
|--|--|---|---------------|
| <b>Name</b>  | Specify a name for the object.   | 1 to 32 characters  | N/A           |
| <b>Object Type</b>   | <p>Select a type for the object.</p> <p><b>IP Address and Subnet:</b> You can specify an IP address, a range of IP addresses, or a subnet.</p> <p><b>Network Service:</b> You can select from a list of protocol and port combinations used for common network services.</p> <p><b>Industrial Application Service:</b> You can select from a list of protocol and port combinations used for industrial communications and applications.</p> <p><b>User-defined Service:</b> You can specify your own protocol and port combination.</p> | IP Address and Subnet / Network Service / Industrial Application Service / User-defined Service | N/A           |
| <b>IP Type</b>   | Select the type of IP address to use for the object.   | Single IP / IP Range / Subnet   | N/A           |
| <b>IP Address (If Single is selected for IP Type)</b>          | Specify the IP address to use for the object.  | Valid IP Address  | N/A           |
| <b>IP Address: Start (If IP Range is selected for IP Type)</b> | Specify the start of the IP range to use for the object.   | Valid IP Address  | N/A           |

| UI Setting   | Description   | Valid Range                    | Default Value |
|--|---|--------------------------------|---------------|
| <b>IP Address: End</b><br><b>(If IP Range is selected for IP Type)</b> | Specify the end of the IP range to use for the object.      | Valid IP Address               | N/A           |
| <b>Subnet</b><br><b>(If Subnet is selected for IP Type)</b>            | Specify the IP address of the subnet to use for the object. | Valid IP Address               | N/A           |
| <b>Subnet Mask</b><br><b>(If Subnet is selected for IP Type)</b>       | Select the subnet mask to use for the object.               | Drop-down list of subnet masks | N/A           |

## Create Object - Network Service

If **Network Service** is selected for the **Object Type**, these settings will appear.

**Create Object**

Name \*  0 / 32

Object Type   
 Network Service ▼

Select Network Service(s)

- >  Remote-Access
- >  Remote-Desktop
- >  Email
- >  File-Transfer
- >  Web-Access
- >  Network-Service
- >  Authentication
- >  VOIP-and-Streaming
- >  SQL-Server

CANCEL CREATE

| UI Setting                       | Description  | Valid Range  | Default Value |
|----------------------------------|--|--|---------------|
| <b>Name</b>                      | Specify a name for the object.   | 1 to 32 characters   | N/A           |
| <b>Object Type</b>               | <p>Select a type for the object.</p> <p><b>IP Address and Subnet:</b> You can specify an IP address, a range of IP addresses, or a subnet.</p> <p><b>Network Service:</b> You can select from a list of protocol and port combinations used for common network services.</p> <p><b>Industrial Application Service:</b> You can select from a list of protocol and port combinations used for industrial communications and applications.</p> <p><b>User-defined Service:</b> You can specify your own protocol and port combination.</p> | IP Address and Subnet / Network Service / Industrial Application Service / User-defined Service  | N/A           |
| <b>Select Network Service(s)</b> | Select a category of network services, or individual services to use for the object. You can select multiple options.  | Remote-Access / Remote-Desktop / Email / File-Transfer / Web-Access / Network-Service / Authentication / VOIP-and-Streaming / SQL-Server   | N/A           |
| <b>Remote-Access</b>             | This category includes protocols used for remote access to a device.   | WINS (TCP 1512; UDP 1512)<br>TELNET (TCP 23)<br>SSH (TCP 22)   | N/A           |
| <b>Remote-Desktop</b>            | This category includes protocols used by various remote desktop services.  | PC-Anywhere (TCP 5631; UDP 5632)<br>Chrome-Remote-Desktop (UDP 5222)<br>AnyDesk (TCP 6568, 7070; UDP 50001 - 50003)<br>Teamviewer (TCP 5938)<br>RDP (TCP 3389)<br>VNC (TCP 5900)<br>X-WINDOW (TCP 6000 - 6063) | N/A           |
| <b>Email</b>                     | This category includes protocols used for sending and receiving emails.  | IMAP (TCP 143)<br>IMAPS (TCP 993)<br>POP3 (TCP 110)<br>POP3S (TCP 995)<br>SMTP (TCP 25)<br>SMTPS (TCP 465)   | N/A           |

| UI Setting                | Description   | Valid Range  | Default Value |
|---------------------------|---|--|---------------|
| <b>File-Transfer</b>      | This category includes protocols used for different methods of file transfer. | FTP (TCP 21)<br>FTPS (TCP 990)<br>SFTP (TCP 115; UDP 115)<br>TFTP (UDP 69)<br>NFS (TCP 111, 2049; UDP 111, 2049)<br>SAMBA (TCP 139)<br>AFS3 (TCP 7000 - 7009; UDP 7000 - 7009)<br>SMB (TCP 445)  | N/A           |
| <b>Web-Access</b>         | This category includes protocols used by web browsers.                        | HTTP (TCP 80)<br>HTTPS (TCP 443)   | N/A           |
| <b>Network-Service</b>    | This category includes protocols used by various network services.            | BGP (TCP 179)<br>DHCP (UDP 67)<br>DHCP6 (UDP 546)<br>DNS (TCP 53; UDP 53)<br>NTP (TCP 123; UDP 123)<br>ICMP-PING (ICMP Type Any Code Any)<br>OSPF (IP Protocol 89)<br>RIP (TCP 520)<br>SNMP (TCP 161 - 162; UDP 161 - 162)<br>SYSLOG (UDP 514) | N/A           |
| <b>Authentication</b>     | This category includes protocols used by authentication services.             | LDAP (TCP 389; UDP 389)<br>LDAPS (TCP 636; UDP 636)<br>RADIUS (UDP 1812 - 1813)<br>TACACS+ (TCP 49; UDP 49)  | N/A           |
| <b>VOIP-and-Streaming</b> | This category includes protocols used for VOIP calling and streaming video.   | SIP (TCP 5060; UDP 5060)<br>RSTP (TCP 554, 7070, 8554; UDP 554)  | N/A           |
| <b>SQL-Server</b>         | This category includes protocols used for SQL servers.                        | MS-SQL (TCP 1433 - 1434)<br>MYSQL (TCP 3306)   | N/A           |

## Create Object - Industrial Application Service

If **Industrial Application Service** is selected for the **Object Type**, these settings will appear.

**Create Object**

Name \*  0 / 32

Object Type  
Industrial Application Service

Select Industrial Application Service(s)

- Modbus (TCP 502; UDP 502)
- DNP3 (TCP 20000)
- IEC-60870-5-104 (TCP 2404)
- IEC-61850-MMS (TCP 102)
- OPC-DA (TCP 135)
- OPC-UA (TCP 4840; UDP 4840)
- CIP-EtherNet/IP (TCP 44818; UDP 2222)
- Siemens-Step7 (TCP 102)
- Moxa-RealCOM (TCP 950 - 981)
- Moxa-MXview-Request (TCP 161, 162, 443, 4000; UDP 4000, 40404)

| UI Setting         | Description  | Valid Range   | Default Value |
|--------------------|--|---|---------------|
| <b>Name</b>        | Specify a name for the object.   | 1 to 32 characters  | N/A           |
| <b>Object Type</b> | <p>Select a type for the object.</p> <p><b>IP Address and Subnet:</b> You can specify an IP address, a range of IP addresses, or a subnet.</p> <p><b>Network Service:</b> You can select from a list of protocol and port combinations used for common network services.</p> <p><b>Industrial Application Service:</b> You can select from a list of protocol and port combinations used for industrial communications and applications.</p> <p><b>User-defined Service:</b> You can specify your own protocol and port combination.</p> | IP Address and Subnet / Network Service / Industrial Application Service / User-defined Service | N/A           |

| UI Setting                                      | Description   | Valid Range   | Default Value |
|---|---|---|---------------|
| <b>Select Industrial Application Service(s)</b> | Select a category of network services, or individual services to use for the object. You can select multiple options. | Modbus (TCP 502; UDP 502)<br>DNP3 (TCP 20000)<br>IEC-60870-5-104 (TCP 2404)<br>IEC-61850-MMS (TCP 102)<br>OPC-DA (TCP 135)<br>OPC-UA (TCP 4840; UDP 4840)<br>CIP-EtherNet/IP (TCP 44818; UDP 2222)<br>Siemens-Step7 (TCP 102)<br>Moxa-RealCOM (TCP 950 - 981)<br>Moxa-MXview-Request (TCP 161, 162, 443, 4000; UDP 4000, 40404) | N/A           |

## Create Object - User-defined Service

If **User-defined Service** is selected for the **Object Type**, these settings will appear.

**Create Object**

Name \*  
test\_moxa  
9 / 32

Object Type \*  
IP Address and Subnet ▼

IP Type \*  
▼

CANCEL
CREATE

| UI Setting  | Description                    | Valid Range        | Default Value |
|-------------|--------------------------------|--------------------|---------------|
| <b>Name</b> | Specify a name for the object. | 1 to 32 characters | N/A           |



| UI Setting  | Description  | Valid Range   | Default Value |
|---|--|---|---------------|
| <b>Object Type</b>  | <p>Select a type for the object.</p> <p><b>IP Address and Subnet:</b> You can specify an IP address, a range of IP addresses, or a subnet.</p> <p><b>Network Service:</b> You can select from a list of protocol and port combinations used for common network services.</p> <p><b>Industrial Application Service:</b> You can select from a list of protocol and port combinations used for industrial communications and applications.</p> <p><b>User-defined Service:</b> You can specify your own protocol and port combination.</p> | IP Address and Subnet / Network Service / Industrial Application Service / User-defined Service | N/A           |
| <b>IP Protocol</b>  | Select the IP protocols to use for the object.   | TCP / UDP / TCP and UDP / ICMP Custom IP Protocol   | N/A           |
| <b>Service Port Type</b><br>(If TCP, UDP, or TCP and UDP is selected for IP Protocol) | <p>Select how to define ports for the object.</p> <p><b>Any:</b> All ports will be included.</p> <p><b>Single TCP and UDP Port:</b> Specify a single port to include.</p> <p><b>TCP and UDP Port Range:</b> Specify a range of ports to include.</p>   | Any / Single TCP and UDP Port / TCP and UDP Port Range  |               |
| <b>Port</b><br>(If Single TCP and UDP Port is selected for Service Port Type)         | Specify a port to include.   | 1 to 65535  | N/A           |
| <b>Port: Start</b><br>(If TCP and UDP Port Range is selected for Service Port Type)   | Specify the start of the port range to use for the object.   | 1 to 65535  | N/A           |
| <b>Port: End</b><br>(If TCP and UDP Port Range is selected for Service Port Type)     | Specify the end of the port range to use for the object.   | 1 to 65535  | N/A           |
| <b>ICMP Type (Decimal)</b><br>(If ICMP is selected for IP Protocol)                   | Specify the ICMP type in decimal form to use for the object. Leave this blank to allow all ICMP types to be included.  | Blank, 0 to 255   | N/A           |

| UI Setting  | Description   | Valid Range     | Default Value |
|---|---|-----------------|---------------|
| <b>ICMP Code (Decimal)</b><br>(If ICMP is selected for IP Protocol)                 | Specify the ICMP code in decimal form to use for the object. Leave this blank to allow all ICMP codes to be included. | Blank, 0 to 255 | N/A           |
| <b>IP Protocol (Decimal)</b><br>(If Custom IP Protocol is selected for IP Protocol) | Specify the IP protocol in decimal form to use for the object.  | 0 to 255        | N/A           |

## Delete Object

### Menu Path: Object Management

You can delete an object by using the checkboxes to select the entries you want to delete, then clicking the **Delete (🗑)** icon.

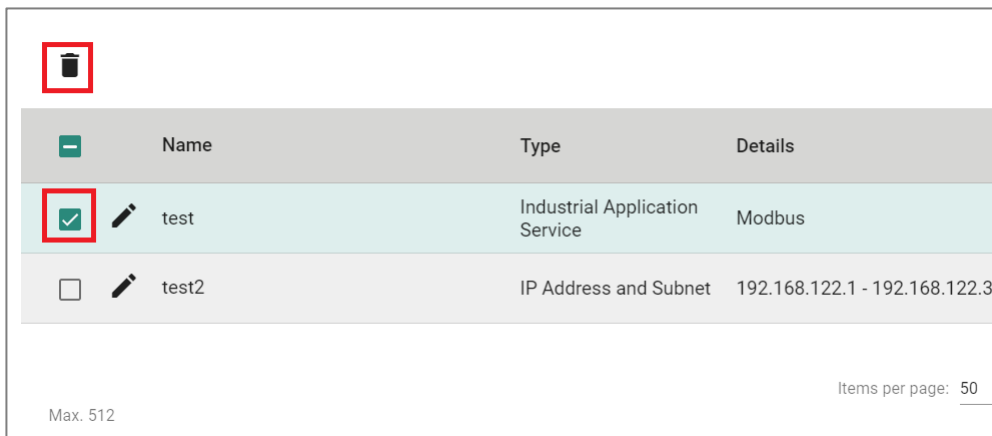

The screenshot shows a table with the following data:

|  | Name  | Type                           | Details                       |
|---|-------|--------------------------------|-------------------------------|
| <input checked="" type="checkbox"/>   | test  | Industrial Application Service | Modbus                        |
| <input type="checkbox"/>  | test2 | IP Address and Subnet          | 192.168.122.1 - 192.168.122.3 |

Max. 512 Items per page: 50

# Firewall

## Menu Path: Firewall

The Firewall settings area lets you configure settings related to your device's firewall.

This settings area includes these sections:

- Layer 2 Policy
- Layer 3-7 Policy
- Layer 3 Policy
- Malformed Packets
- Session Control
- DoS Policy
- Soft Lockdown Mode
- Advanced Protection
- Device Lockdown

## Network Configuration - User Privileges

Privileges to Firewall settings are granted to the different authority levels as follows.

Refer to [System > Account Management > User Accounts](#) for more information on user accounts.

| Settings                  | Admin | Supervisor | User |
|---------------------------|-------|------------|------|
| <b>Layer 2 Policy</b>     | R/W   | R/W        | R    |
| <b>Layer 3 - 7 Policy</b> | R/W   | R/W        | R    |
| <b>Layer 3 Policy</b>     | R/W   | R/W        | R    |
| <b>Malformed Packets</b>  | R/W   | R/W        | R    |
| <b>Session Control</b>    | R/W   | R/W        | R    |
| <b>DoS Policy</b>         | R/W   | R/W        | R    |

| Settings                      | Admin | Supervisor | User |
|-------------------------------|-------|------------|------|
| <b>Soft Lockdown Mode</b>     | R/W   | R/W        | R    |
| <b>Advanced Protection</b>    |       |            |      |
| <b>Dashboard</b>              | R/W   | R/W        | -    |
| <b>Configuration</b>          | R/W   | R/W        | -    |
| <b>Protocol Filter Policy</b> | R/W   | R/W        | -    |
| <b>ADP</b>                    | R/W   | R/W        | -    |
| <b>IPS</b>                    | R/W   | R/W        | -    |
| <b>Device Lockdown</b>        | R/W   | R/W        | R    |

## Layer 2 Policy

### Menu Path: Firewall > Layer 2 Policy

This page lets you configure advanced Layer 2 policies for your device's firewall. Layer 2 firewall policies can filter packets from bridge ports and have a higher priority than Layer 3 policies.

#### Note

Packets are checked by using the policy with the lowest index number first. If the packet matches the policy, the defined action will be taken and the remaining rules will not be run for the packet. If the packet does not match the policy, the next policy will be used.

#### Limitations

You can create up to 256 Layer 2 policies.

| <input type="checkbox"/> | Status  | Index | Event              | Incoming Bridge Port | Outgoing Bridge Port | Ether Type | Source MAC | Destination MAC | Action |
|--------------------------|---|-------|--------------------|----------------------|----------------------|------------|------------|-----------------|--------|
| <input type="checkbox"/> |  Enabled | 1     | Disabled/Emergency | Any BRG Members      | Any BRG Members      | Any        | Any        | Any             | Accept |

Max. 256 Items per page: 10 1 - 1 of 1 |< < > >|

**APPLY**

| UI Setting                  | Description  |
|-----------------------------|--|
| <b>Status</b>               | Shows whether the policy is enabled or disabled.   |
| <b>Index</b>                | Shows the index of the policy. The index determines the order for processing policies.             |
| <b>Event</b>                | Shows whether logging is enabled or disabled for the event and the severity assigned to the event. |
| <b>Incoming Bridge Port</b> | Shows the incoming bridge port for the policy.   |
| <b>Outgoing Bridge Port</b> | Shows the outgoing bridge port for the policy.   |
| <b>Ether Type</b>           | Shows the EtherType that the policy applies to.  |
| <b>Source MAC</b>           | Shows the source MAC the policy applies to.  |
| <b>Destination MAC</b>      | Shows the destination MAC the policy applies to.   |
| <b>Action</b>               | Shows the action that will be taken for applicable traffic.  |

## Edit Layer 2 Policy

### Menu Path: Firewall > Layer 2 Policy

Clicking the **Edit** (  ) icon for a policy on the **Firewall > Layer 2 Policy** page will open this dialog box. This dialog lets you modify an existing policy. Click **APPLY** to save your changes.

### Edit Layer 2 Policy

Status \*  
Enabled

Index \*  
1

Log \*  
Disabled

Severity \*  
Emergency

Log Destination

Incoming Bridge Port \*  
Any

Outgoing Bridge Port \*  
Any

EtherType Options \*  
IPv4

EtherType Value (Hexadecimal)  
0x0800

Action \*  
Accept

Source MAC Type \*  
Any

Destination MAC Type \*  
Any

CANCEL APPLY

| UI Setting      | Description  | Valid Range   | Default Value          |
|-----------------|--|---|------------------------|
| <b>Status</b>   | Enable or disable the policy.  | Enabled / Disabled  | Enabled                |
| <b>Index</b>    | Specify the index number for the policy. The index determines the order for processing policies.   | 1 to 256  | Last used index plus 1 |
| <b>Log</b>      | Enable or disable firewall event logging for this policy.  | Enabled / Disabled  | Enabled                |
| <b>Severity</b> | Select the severity level to assign events for this policy. Refer to the <a href="#">Severity Level List</a> for more information about severity levels. | Emergency / Alert / Critical / Error / Warning / Notice / Informational / Debug | N/A                    |

| UI Setting  | Description  | Valid Range   | Default Value                                   |
|---|--|---|---|
| <b>Log Destination</b>  | <p>Specify where to send firewall event logs. You can select multiple options.</p> <p><b>Local Storage:</b> Firewall event logs will be stored on local storage and will show up in the device's Event Log. Refer to <a href="#">Diagnostics &gt; Event Logs and Notifications &gt; Event Log</a> for more information.</p> <p><b>Syslog:</b> Firewall event logs will be sent to a syslog server. Refer to <a href="#">Diagnostics &gt; Event Logs and Notifications &gt; Syslog</a> for more information.</p> <p><b>Trap:</b> Firewall event notifications will be sent to a trap server. Refer to <a href="#">Diagnostics &gt; SNMP Trap/Inform</a> for more information.</p> | Local Storage / Syslog / Trap   | N/A   |
| <b>Incoming Bridge Port</b>                                     | Select the incoming bridge port for this policy.   | Any   | Any   |
| <b>Outgoing Bridge Port</b>                                     | Select the outgoing bridge port for this policy.   | Any   | Any   |
| <b>EtherType Options</b>  | Select the Layer 2 EtherType protocol that this policy should apply to. You can select a type from the drop-down list, or you can select Manual to specify one manually. Refer to <a href="#">Appendix &gt; EtherTypes for Layer 2</a> for more information about common EtherTypes.   | Any / Manual / IPv4 / X25 / ARP / Frame Relay ARP / G8BPQ AX.25 Ethernet Packet / DEC Assigned proto / DEC DNA Dump/Load / DEC DNA Remote Console / DEC DNA Routing / DEC LAT / DEC Diagnostics / DEC Customer use / DEC Systems Comms Arch / Trans Ether Bridging / Raw Frame Relay / Appletalk AARP / Appletalk / 802.1Q Virtual LAN tagged frame / Novell IPX / NetBEUI / IP version 6 / PPP / MultiProtocol over ATM / PPPoE discovery messages / PPPoE session messages / Frame-based ATM Transport over Ethernet / Loopback | Any   |
| <b>Manual (if EtherType Options is anything other than Any)</b> | <p>If <b>EtherType Options</b> is set to <b>Manual</b>, enter the EtherType value in hexadecimal this policy should apply to.</p> <p>If <b>EtherType Options</b> is set to a predefined <b>EtherType</b>, its value will be shown here and cannot be changed.</p>  | Valid EtherType hex code  | N/A, EtherType value for the selected EtherType |

| UI Setting                  | Description   | Valid Range   | Default Value |
|-----------------------------|---|---------------|---------------|
| <b>Action</b>               | <p>Select the action the firewall should take for traffic that matches this policy.</p> <p><b>Accept:</b> The firewall will accept packets that match the policy.</p> <p><b>Drop:</b> The firewall will drop packets that match the policy.</p>                             | Accept / Drop | Accept        |
| <b>Source MAC Type</b>      | <p>Select which source MAC addresses to check with this policy.</p> <p><b>Any:</b> The firewall will check packets coming from all source MAC addresses.</p> <p><b>Single:</b> The firewall will only check packets coming from a specified source MAC address.</p>         | Any / Single  | Any           |
| <b>Destination MAC Type</b> | <p>Select which destination MAC addresses to check with this policy.</p> <p><b>Any:</b> The firewall will check packets going to all destination MAC addresses.</p> <p><b>Single:</b> The firewall will only check packets going to a specific destination MAC address.</p> | Any / Single  | Any           |

## Add Layer 2 Policy

### Menu Path: Firewall > Layer 2 Policy

Clicking the **Add (+)** icon on the **Firewall > Layer 2 Policy** page will open this dialog box. This dialog lets you create a new policy. Click **CREATE** to save your changes and add the new policy.



### Add Layer 2 Policy

Status \*  
Enabled ▾

Index \*  
2  
1 - 2

Log \*  
Enabled ▾    Severity \* ▾    Log Destination ▾

Incoming Bridge Port \*  
Any ▾    Outgoing Bridge Port \*  
Any ▾

EtherType Options \*  
Any ▾

Action \*  
Accept ▾

Source MAC Type \*  
Any ▾

Destination MAC Type \*  
Any ▾

CANCEL    CREATE

| UI Setting      | Description  | Valid Range   | Default Value          |
|-----------------|--|---|------------------------|
| <b>Status</b>   | Enable or disable the policy.  | Enabled / Disabled  | Enabled                |
| <b>Index</b>    | Specify the index number for the policy. The index determines the order for processing policies.   | 1 to 256  | Last used index plus 1 |
| <b>Log</b>      | Enable or disable firewall event logging for this policy.  | Enabled / Disabled  | Enabled                |
| <b>Severity</b> | Select the severity level to assign events for this policy. Refer to the <a href="#">Severity Level List</a> for more information about severity levels. | Emergency / Alert / Critical / Error / Warning / Notice / Informational / Debug | N/A                    |

| UI Setting  | Description  | Valid Range   | Default Value                                   |
|---|--|---|---|
| <b>Log Destination</b>  | <p>Specify where to send firewall event logs. You can select multiple options.</p> <p><b>Local Storage:</b> Firewall event logs will be stored on local storage and will show up in the device's Event Log. Refer to <a href="#">Diagnostics &gt; Event Logs and Notifications &gt; Event Log</a> for more information.</p> <p><b>Syslog:</b> Firewall event logs will be sent to a syslog server. Refer to <a href="#">Diagnostics &gt; Event Logs and Notifications &gt; Syslog</a> for more information.</p> <p><b>Trap:</b> Firewall event notifications will be sent to a trap server. Refer to <a href="#">Diagnostics &gt; SNMP Trap/Inform</a> for more information.</p> | Local Storage / Syslog / Trap   | N/A   |
| <b>Incoming Bridge Port</b>                                     | Select the incoming bridge port for this policy.   | Any   | Any   |
| <b>Outgoing Bridge Port</b>                                     | Select the outgoing bridge port for this policy.   | Any   | Any   |
| <b>EtherType Options</b>  | Select the Layer 2 EtherType protocol that this policy should apply to. You can select a type from the drop-down list, or you can select Manual to specify one manually. Refer to <a href="#">Appendix &gt; EtherTypes for Layer 2</a> for more information about common EtherTypes.   | Any / Manual / IPv4 / X25 / ARP / Frame Relay ARP / G8BPQ AX.25 Ethernet Packet / DEC Assigned proto / DEC DNA Dump/Load / DEC DNA Remote Console / DEC DNA Routing / DEC LAT / DEC Diagnostics / DEC Customer use / DEC Systems Comms Arch / Trans Ether Bridging / Raw Frame Relay / Appletalk AARP / Appletalk / 802.1Q Virtual LAN tagged frame / Novell IPX / NetBEUI / IP version 6 / PPP / MultiProtocol over ATM / PPPoE discovery messages / PPPoE session messages / Frame-based ATM Transport over Ethernet / Loopback | Any   |
| <b>Manual (if EtherType Options is anything other than Any)</b> | <p>If <b>EtherType Options</b> is set to <b>Manual</b>, enter the EtherType value in hexadecimal this policy should apply to.</p> <p>If <b>EtherType Options</b> is set to a predefined <b>EtherType</b>, its value will be shown here and cannot be changed.</p>  | Valid EtherType hex code  | N/A, EtherType value for the selected EtherType |

| UI Setting                  | Description  | Valid Range   | Default Value |
|-----------------------------|--|---------------|---------------|
| <b>Action</b>               | Select the action the firewall should take for traffic that matches this policy.<br><br><b>Accept:</b> The firewall will accept packets that match the policy.<br><b>Drop:</b> The firewall will drop packets that match the policy.                             | Accept / Drop | Accept        |
| <b>Source MAC Type</b>      | Select which source MAC addresses to check with this policy.<br><br><b>Any:</b> The firewall will check packets coming from all source MAC addresses.<br><b>Single:</b> The firewall will only check packets coming from a specified source MAC address.         | Any / Single  | Any           |
| <b>Destination MAC Type</b> | Select which destination MAC addresses to check with this policy.<br><br><b>Any:</b> The firewall will check packets going to all destination MAC addresses.<br><b>Single:</b> The firewall will only check packets going to a specific destination MAC address. | Any / Single  | Any           |

## Delete Layer 2 Policy

### Menu Path: Firewall > Layer 2 Policy

You can delete a policy by using the checkboxes to select the entries you want to delete, then clicking the **Delete** (  ) icon.

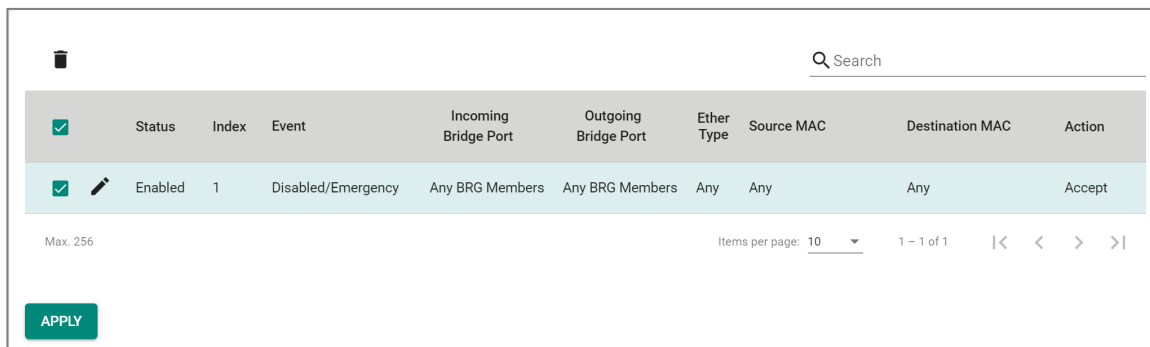

The screenshot shows a table with the following columns: Status, Index, Event, Incoming Bridge Port, Outgoing Bridge Port, Ether Type, Source MAC, Destination MAC, and Action. A trash icon is located in the top left corner of the interface. The table contains one row with the following values: Status: Enabled, Index: 1, Event: Disabled/Emergency, Incoming Bridge Port: Any BRG Members, Outgoing Bridge Port: Any BRG Members, Ether Type: Any, Source MAC: Any, Destination MAC: Any, Action: Accept. Below the table, there is a search bar, a dropdown menu for 'Items per page' set to 10, and navigation arrows. An 'APPLY' button is located at the bottom left of the interface.

## Reorder Layer 2 Policies

### Menu Path: Firewall > Layer 2 Policy

You can reorder policies by clicking the **Reorder Priorities** (↑≡) icon, moving the entries into the order you want, then clicking the **Reorder Priorities** (↑≡) icon again.

Reordering policies affects the order used to process the policies.

| Status  | Index | Event              | Incoming Bridge Port | Outgoing Bridge Port | Ether Type | Source MAC |
|---------|-------|--------------------|----------------------|----------------------|------------|------------|
| Enabled | 1     | Disabled/Emergency | Any BRG Members      | Any BRG Members      | Any        | Any        |

## Layer 3-7 Policy

### Menu Path: Firewall > Layer 3-7 Policy

This page lets you configure Layer 3-7 policies to secure and control network traffic. Click **APPLY** to save your changes.

#### Note

Packets are checked by using the policy with the lowest index number first. If the packet matches the policy, the defined action will be taken and the remaining rules will not be run for the packet. If the packet does not match the policy, the next policy will be used.

#### Limitations

You can create up to 1024 Layer 3-7 policies.

## Layer 3-7 Policy Settings

### Global Policy Settings

| UI Setting            | Description  | Valid Range          | Default Value |
|-----------------------|--|----------------------|---------------|
| <b>Status</b>         | Enable or disable Layer 3-7 policy settings.   | Enabled / Disabled   | Disabled      |
| <b>Default Action</b> | Select what the default action should be for traffic that doesn't match any of the configured firewall rules.<br><br><b>Allow All:</b> Allow all network traffic that does not match any rule.<br><br><b>Deny All:</b> Block all network traffic that does not match any rule. | Allow All / Deny All | Deny All      |

### Global Policy Event Settings

| UI Setting                            | Description   | Valid Range   | Default Value |
|---------------------------------------|---|---|---------------|
| <b>Log</b>                            | Enable or disable global policy event logging. This will allow event logging for actions taken due to the global policy.                                | Enabled / Disabled  | Enabled       |
| <b>Default Action Log</b>             | Enable or disable default action log.   | Enabled / Disabled  | Disabled      |
| <b>Default Action Severity</b>        | Select the severity level to assign events for this policy. Refer to <a href="#">Appendix &gt; Severity</a> for more information about severity levels. | Emergency / Alert / Critical / Error / Warning / Notice / Informational / Debug | N/A           |
| <b>Default Action Log Destination</b> | Select the default action log destination.  | Syslog / Trap / Local Storage   | N/A           |

## Layer 3-7 Policy List

The screenshot shows a web interface for managing Layer 3-7 policies. At the top, there is a search bar and a table header with the following columns: Index, Status, Name, Event, Incoming Interface, Outgoing Interface, Filter Mode, Source Address, Source Port, Destination Address, Destination Port or Protocol, Action, and Description. Below the header, there is a table body with a maximum of 1024 items. The interface also includes a pagination control showing 'Items per page: 50' and '0 of 0' items. An 'APPLY' button is located at the bottom left of the table area.

| UI Setting                          | Description  |
|-------------------------------------|--|
| <b>Index</b>                        | Shows the index of the policy. The index determines the order for processing policies.             |
| <b>Status</b>                       | Shows whether the policy is enabled or disabled.   |
| <b>Name</b>                         | Shows the name of the policy.  |
| <b>Event</b>                        | Shows whether logging is enabled or disabled for the event and the severity assigned to the event. |
| <b>Incoming Interface</b>           | Shows the incoming interface for the policy.   |
| <b>Outgoing Interface</b>           | Shows the outgoing interface for the policy.   |
| <b>Filter Mode</b>                  | Shows the filter mode used for the policy.   |
| <b>Source Address</b>               | Shows the source IP addresses the policy applies to.   |
| <b>Source Port</b>                  | Shows the source ports the policy applies to.  |
| <b>Destination Address</b>          | Shows the destination IP addresses the policy applies to.  |
| <b>Destination Port or Protocol</b> | Shows the destination ports or protocols the policy applies to.                                    |
| <b>Action</b>                       | Shows the action that will be taken for applicable traffic.  |
| <b>Description</b>                  | Shows the description of the policy.   |

## Edit Layer 3-7 Policy

### Menu Path: Firewall > Layer 3-7 Policy

Clicking the **Edit** (↗) icon for a policy on the **Firewall > Layer 3-7 Policy** page will open this dialog box. This dialog lets you modify an existing policy. Click **APPLY** to save your changes.

### Edit Layer 3-7 Policy

Index \*  
1

1 - 1024

Status \*  
Enabled

Name \*  
TestPolicy  
10 / 32

Description  
0 / 128

Log \*  
Disabled

Severity \*  
Warning

Log Destination  
Local Storage

Incoming Interface \*  
Any

Outgoing Interface \*  
Any

Action \*  
Allow

Filter Mode \*  
IP and Port Filtering

Source IP Address \*  
Any

Source Port \*  
Any

CANCEL APPLY

| UI Setting                | Description   | Valid Range   | Default Value          |
|---------------------------|---|---|------------------------|
| <b>Index</b>              | Specify the index number for the policy. The index determines the order for processing policies.  | 1 to 1024   | Last used index plus 1 |
| <b>Status</b>             | Enable or disable the policy.   | Enabled / Disabled  | Enabled                |
| <b>Name</b>               | Specify a name for the policy.  | 1 to 32 characters  | N/A                    |
| <b>Description</b>        | Specify a description for the policy.   | 0 to 128 characters   | N/A                    |
| <b>Log</b>                | Enable or disable firewall event logging for this policy.   | Enabled / Disabled  | Enabled                |
| <b>Severity</b>           | Select the severity level to assign events for this policy. Refer to <a href="#">Appendix &gt; Severity</a> for more information about severity levels.   | Emergency / Alert / Critical / Error / Warning / Notice / Informational / Debug | N/A                    |
| <b>Log Destination</b>    | Specify where to send firewall event logs. You can select multiple options.<br><br><b>Local Storage:</b> Firewall event logs will be stored on local storage and will show up in the device's Event Log. Refer to <a href="#">Diagnostics &gt; Event Logs and Notifications &gt; Event Log</a> for more information.<br><br><b>Syslog:</b> Firewall event logs will be sent to a syslog server. Refer to <a href="#">Diagnostics &gt; Event Logs and Notifications &gt; Syslog</a> for more information.<br><br><b>Trap:</b> Firewall event notifications will be sent to a trap server. Refer to <a href="#">Diagnostics &gt; SNMP Trap/Inform</a> for more information. | Local Storage / Syslog / Trap   | N/A                    |
| <b>Incoming Interface</b> | Select the incoming interface for this policy.<br><br><b>Note</b><br>Available interfaces will vary depending on your product model and configuration. Refer to <a href="#">Network Configuration &gt; Network Interfaces</a> for more information about managing your device's interfaces.   | Any / Drop-down list of interfaces  | Any                    |



| UI Setting   | Description   | Valid Range  | Default Value         |
|--|---|--|-----------------------|
| <b>Outgoing Interface</b>  | <p>Select the outgoing interface for this policy.</p> <div style="border: 1px solid #ccc; background-color: #f9f9f9; padding: 10px; margin-top: 10px;"> <p> <b>Note</b></p> <p>Available interfaces will vary depending on your product model and configuration. Refer to <a href="#">Network Configuration &gt; Network Interfaces</a> for more information about managing your device's interfaces.</p> </div> | Any / Drop-down list of interfaces                                       | Any                   |
| <b>Action</b>  | <p>Select the action the firewall should take for traffic that matches this policy.</p> <p><b>Accept:</b> The firewall will accept packets that match the policy.</p> <p><b>Drop:</b> The firewall will drop packets that match the policy.</p>   | Accept / Drop  | Accept                |
| <b>Filter Mode</b>   | <p>Select the filter mode to use for packet filtering.</p> <p><b>IP and Port Filtering:</b> The policy will filter based on IP address and port.</p> <p><b>IP and Source MAC Binding:</b> The policy will filter based on IP address and will also check the source MAC address.</p> <p><b>Source MAC Filtering:</b> The policy will filter based on source MAC address.</p>  | IP and Port Filtering / IP and Source MAC Binding / Source MAC Filtering | IP and Port Filtering |
| <b>Source IP Address</b><br>(if Filter Mode is IP and Port Filtering or IP and Source MAC Binding) | <p>Select the source IP addresses this policy will apply to. Select <b>Any</b> to check traffic from all source IP addresses, or select a pre-defined object. You can also click the Add (+) icon to create a new IP Address and Subnet object. Refer to <a href="#">Create Object</a> for more information.</p>  | Any / Drop-down list of IP Address and Subnet objects                    | Any                   |
| <b>Source Port</b><br>(if Filter Mode is IP and Port Filtering)                                    | <p>Select the source ports this policy will apply to. Select <b>Any</b> to check traffic from all source ports, or select a pre-defined object. You can also click the Add (+) icon to create a new User-defined Service object. Refer to <a href="#">Create Object</a> for more information.</p>   | Any / Drop-down list of port-based User-defined Service objects          | Any                   |
| <b>Source MAC Address</b><br>(if Filter Mode is IP and Source MAC Binding or Source MAC Filtering) | <p>Specify the source MAC address this policy will apply to.</p>  | Valid MAC address  | N/A                   |

| UI Setting  | Description   | Valid Range  | Default Value |
|---|---|--|---------------|
| <b>Destination IP Address</b><br><b>(if Filter Mode is IP and Port Filtering)</b>       | Select the destination IP addresses this policy will apply to. Select <b>Any</b> to check all traffic going to any destination IP address, or select a pre-defined object. You can also click the Add (+) icon to create a new IP Address and Subnet object.<br><br>Refer to <a href="#">Create Object</a> for more information.  | Any / Drop-down list of IP Address and Subnet objects  | Any           |
| <b>Destination Port or Protocol</b><br><b>(if Filter Mode is IP and Port Filtering)</b> | Select the destination ports or protocol this policy will apply to. Select <b>Any</b> to check all traffic going to any destination port or protocol, or select a pre-defined service or object. You can also click the Add (+) icon to create a new Network Service, Industrial Application Service, or User-defined Service object.<br><br>Refer to <a href="#">Create Object</a> for more information. | Any / Drop-down list of Network Service, Industrial Application Service, and port-based User-defined Service objects | Any           |

## Create Layer 3-7 Policy

### Menu Path: Firewall > Layer 3-7 Policy

Clicking the **Add (+)** icon on the **Firewall > Layer 3-7 Policy** page will open this dialog box. This dialog lets you create a new policy. Click **CREATE** to save your changes and add the new policy.

**Create Layer 3-7 Policy**

Index \*  
1

1-1024

Status \*  
Enabled

Name \*  
0 / 32

Description  
0 / 128

Log \*  
Disabled

Severity \*  
Warning

Log Destination  
Local Storage

Incoming Interface \*  
Any

Outgoing Interface \*  
Any

Action \*  
Allow

Filter Mode \*  
IP and Port Filtering

Source IP Address \*  
Any

Source Port \*  
Any

Destination IP Address \*  
Any

Destination Port or Protocol \*  
Any

CANCEL CREATE

| UI Setting                | Description   | Valid Range   | Default Value          |
|---------------------------|---|---|------------------------|
| <b>Index</b>              | Specify the index number for the policy. The index determines the order for processing policies.  | 1 to 1024   | Last used index plus 1 |
| <b>Status</b>             | Enable or disable the policy.   | Enabled / Disabled  | Enabled                |
| <b>Name</b>               | Specify a name for the policy.  | 1 to 32 characters  | N/A                    |
| <b>Description</b>        | Specify a description for the policy.   | 0 to 128 characters   | N/A                    |
| <b>Log</b>                | Enable or disable firewall event logging for this policy.   | Enabled / Disabled  | Enabled                |
| <b>Severity</b>           | Select the severity level to assign events for this policy. Refer to <a href="#">Appendix &gt; Severity</a> for more information about severity levels.   | Emergency / Alert / Critical / Error / Warning / Notice / Informational / Debug | N/A                    |
| <b>Log Destination</b>    | Specify where to send firewall event logs. You can select multiple options.<br><br><b>Local Storage:</b> Firewall event logs will be stored on local storage and will show up in the device's Event Log. Refer to <a href="#">Diagnostics &gt; Event Logs and Notifications &gt; Event Log</a> for more information.<br><br><b>Syslog:</b> Firewall event logs will be sent to a syslog server. Refer to <a href="#">Diagnostics &gt; Event Logs and Notifications &gt; Syslog</a> for more information.<br><br><b>Trap:</b> Firewall event notifications will be sent to a trap server. Refer to <a href="#">Diagnostics &gt; SNMP Trap/Inform</a> for more information. | Local Storage / Syslog / Trap   | N/A                    |
| <b>Incoming Interface</b> | Select the incoming interface for this policy.<br><br><b>Note</b><br>Available interfaces will vary depending on your product model and configuration. Refer to <a href="#">Network Configuration &gt; Network Interfaces</a> for more information about managing your device's interfaces.   | Any / Drop-down list of interfaces  | Any                    |

| UI Setting   | Description   | Valid Range  | Default Value         |
|--|---|--|-----------------------|
| <b>Outgoing Interface</b>  | <p>Select the outgoing interface for this policy.</p> <div style="border: 1px solid #ccc; background-color: #f9f9f9; padding: 10px; margin-top: 10px;"> <p> <b>Note</b></p> <p>Available interfaces will vary depending on your product model and configuration. Refer to <a href="#">Network Configuration &gt; Network Interfaces</a> for more information about managing your device's interfaces.</p> </div> | Any / Drop-down list of interfaces                                       | Any                   |
| <b>Action</b>  | <p>Select the action the firewall should take for traffic that matches this policy.</p> <p><b>Accept:</b> The firewall will accept packets that match the policy.</p> <p><b>Drop:</b> The firewall will drop packets that match the policy.</p>   | Accept / Drop  | Accept                |
| <b>Filter Mode</b>   | <p>Select the filter mode to use for packet filtering.</p> <p><b>IP and Port Filtering:</b> The policy will filter based on IP address and port.</p> <p><b>IP and Source MAC Binding:</b> The policy will filter based on IP address and will also check the source MAC address.</p> <p><b>Source MAC Filtering:</b> The policy will filter based on source MAC address.</p>  | IP and Port Filtering / IP and Source MAC Binding / Source MAC Filtering | IP and Port Filtering |
| <b>Source IP Address</b><br>(if Filter Mode is IP and Port Filtering or IP and Source MAC Binding) | <p>Select the source IP addresses this policy will apply to. Select <b>Any</b> to check traffic from all source IP addresses, or select a pre-defined object. You can also click the Add (+) icon to create a new IP Address and Subnet object. Refer to <a href="#">Create Object</a> for more information.</p>  | Any / Drop-down list of IP Address and Subnet objects                    | Any                   |
| <b>Source Port</b><br>(if Filter Mode is IP and Port Filtering)                                    | <p>Select the source ports this policy will apply to. Select <b>Any</b> to check traffic from all source ports, or select a pre-defined object. You can also click the Add (+) icon to create a new User-defined Service object. Refer to <a href="#">Create Object</a> for more information.</p>   | Any / Drop-down list of port-based User-defined Service objects          | Any                   |
| <b>Source MAC Address</b><br>(if Filter Mode is IP and Source MAC Binding or Source MAC Filtering) | <p>Specify the source MAC address this policy will apply to.</p>  | Valid MAC address  | N/A                   |

| UI Setting   | Description   | Valid Range  | Default Value |
|--|---|--|---------------|
| <b>Destination IP Address</b><br>(if Filter Mode is IP and Port Filtering)       | Select the destination IP addresses this policy will apply to. Select <b>Any</b> to check all traffic going to any destination IP address, or select a pre-defined object. You can also click the Add (+) icon to create a new IP Address and Subnet object.<br><br>Refer to <a href="#">Create Object</a> for more information.  | Any / Drop-down list of IP Address and Subnet objects  | Any           |
| <b>Destination Port or Protocol</b><br>(if Filter Mode is IP and Port Filtering) | Select the destination ports or protocol this policy will apply to. Select <b>Any</b> to check all traffic going to any destination port or protocol, or select a pre-defined service or object. You can also click the Add (+) icon to create a new Network Service, Industrial Application Service, or User-defined Service object.<br><br>Refer to <a href="#">Create Object</a> for more information. | Any / Drop-down list of Network Service, Industrial Application Service, and port-based User-defined Service objects | Any           |

## Delete Layer 3-7 Policy

### Menu Path: Firewall > Layer 3-7 Policy

You can delete a policy by using the checkboxes to select the entries you want to delete, then clicking the **Delete** (🗑️) icon.

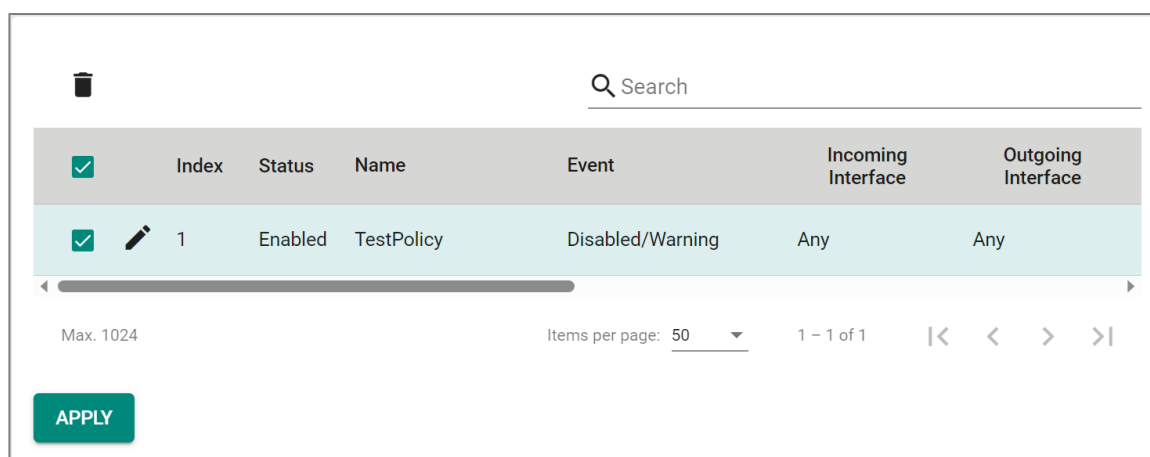

## Reorder Layer 3-7 Policies

### Menu Path: Firewall > Layer 3-7 Policy

You can reorder policies by clicking the **Reorder Priorities** (↑≡) icon, moving the entries into the order you want, then clicking the **Reorder Priorities** (↑≡) icon again.

Reordering policies affects the order used to process the policies.

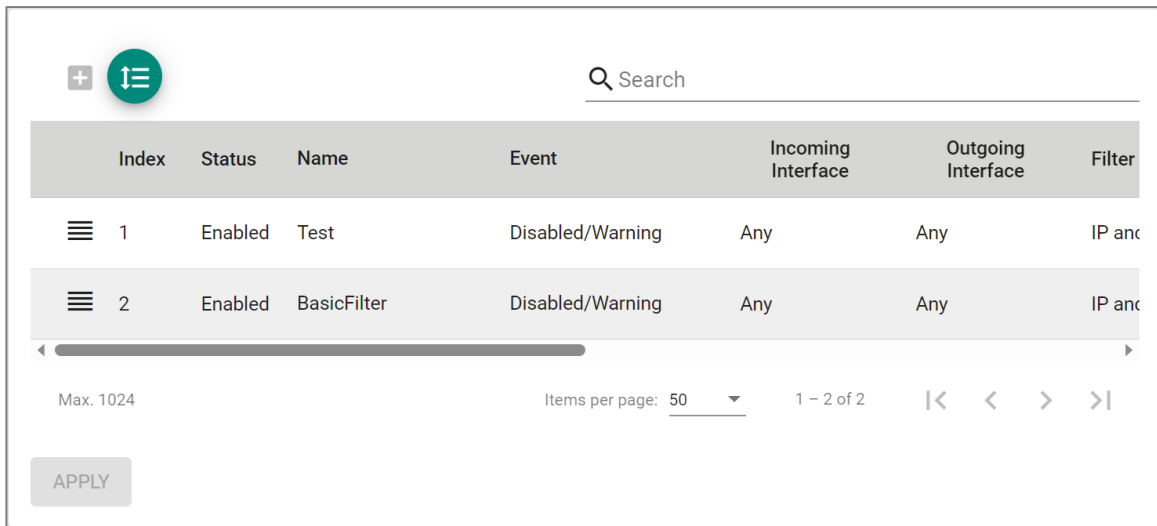

| Index | Status  | Name        | Event            | Incoming Interface | Outgoing Interface | Filter |
|-------|---------|-------------|------------------|--------------------|--------------------|--------|
| 1     | Enabled | Test        | Disabled/Warning | Any                | Any                | IP and |
| 2     | Enabled | BasicFilter | Disabled/Warning | Any                | Any                | IP and |

Max. 1024      Items per page: 50      1 - 2 of 2      << < > >>

APPLY

## Layer 3 Policy

### Menu Path: Firewall > Layer 3 Policy

This page lets you configure Layer 3 policies to secure and control network traffic. Click **APPLY** to save your changes.

#### Note

Availability of this feature may vary depending on your product model and version.

### 🔔 Limitations

You can create up to 32 Layer 3 policies.

## Layer 3 Policy Settings

Firewall Event Log

Disabled ▼

**APPLY**

| UI Setting                | Description   | Valid Range        | Default Value |
|---------------------------|---|--------------------|---------------|
| <b>Firewall Event Log</b> | Enable or disable logging of Layer 3 firewall events. | Enabled / Disabled | Disabled      |

## Layer 3 Policy List

+ ☰ Search

| <input type="checkbox"/> | Index | Status | Name | Protocol | Incoming Interface | Outgoing Interface | Src. IP:Port | Src. MAC | Dst. IP:Port | Action | Event Log/Severity |
|--------------------------|-------|--------|------|----------|--------------------|--------------------|--------------|----------|--------------|--------|--------------------|
|--------------------------|-------|--------|------|----------|--------------------|--------------------|--------------|----------|--------------|--------|--------------------|

Max. 32 0 of 0 < >

**APPLY**

| UI Setting                | Description   |
|---------------------------|---|
| <b>Index</b>              | Shows the index of the policy. Policies with a lower index will be processed before policies with a higher index. |
| <b>Status</b>             | Shows whether the policy is enabled.  |
| <b>Name</b>               | Shows the name of the policy.   |
| <b>Protocol</b>           | Shows the protocol used by the policy.  |
| <b>Incoming Interface</b> | Shows the incoming interface used by the policy.  |
| <b>Outgoing Interface</b> | Shows the outgoing interface used by the policy.  |

| UI Setting                | Description   |
|---------------------------|---|
| <b>Src. IP:Port</b>       | Shows the source IP address and port used by the policy.                        |
| <b>Src. MAC</b>           | Shows the source MAC address and port used by the policy.                       |
| <b>Dst. IP:Port</b>       | Shows the destination IP address and port used by the policy.                   |
| <b>Action</b>             | Shows the action the firewall should take for traffic that matches this policy. |
| <b>Event Log/Severity</b> | Shows the event log destination and severity level for events from this policy. |

## Create Layer 3 Policy

### Menu Path: Firewall > Layer 3 Policy

Clicking the **Add** (  ) icon on the

Unable to render include or excerpt-include. Could not retrieve page.

page will open this dialog box. This dialog lets you create a new Layer 3 policy.

Click **CREATE** to save your changes and add the new policy.



### Create Index 1

Index  
1

Status \*  
Enabled

Name  
0 / 64

Severity  
Emergency Log Destination

From Interface To Interface

Automation Profile  
All

Filter Mode  
IP Address Filter

Action  
ACCEPT

Source IP  
All

Source Port  
All

Destination IP  
All

Destination Port  
All

CANCEL APPLY

| UI Setting    | Description   | Valid Range        | Default Value          |
|---------------|---|--------------------|------------------------|
| <b>Index</b>  | Specify the index number for the policy. Policies with a lower index will be processed before policies with a higher index. | 1 to 1024          | Last used index plus 1 |
| <b>Status</b> | Enable or disable the policy.   | Enabled / Disabled | Enabled                |
| <b>Name</b>   | Specify a name for the policy.  | 1 to 64 characters | N/A                    |

| UI Setting                | Description   | Valid Range   | Default Value |
|---------------------------|---|---|---------------|
| <b>Severity</b>           | Select the severity level to assign events for this policy. Refer to <a href="#">Appendix &gt; Severity</a> for more information about severity levels.   | Emergency / Alert / Critical / Error / Warning / Notice / Informational / Debug | Emergency     |
| <b>Log Destination</b>    | Specify where to send firewall event logs. You can select multiple options.<br><br><b>Local Storage:</b> Firewall event logs will be stored on local storage and will show up in the device's Event Log. Refer to <a href="#">Diagnostics &gt; Event Logs and Notifications &gt; Event Log</a> for more information.<br><br><b>Syslog:</b> Firewall event logs will be sent to a syslog server. Refer to <a href="#">Diagnostics &gt; Event Logs and Notifications &gt; Syslog</a> for more information.<br><br><b>Trap:</b> Firewall event notifications will be sent to a trap server. Refer to <a href="#">Diagnostics &gt; SNMP Trap/Inform</a> for more information. | Local Storage / Syslog / Trap   | N/A           |
| <b>Incoming Interface</b> | Select the incoming interface for this policy.<br><br><div style="background-color: #f0f0f0; padding: 10px; margin-top: 10px;"> <p><b>Note</b></p> <p>Available interfaces will vary depending on your product model and configuration. Refer to <a href="#">Network Configuration &gt; Network Interfaces</a> for more information about managing your device's interfaces.</p> </div>   | Any / Drop-down list of interfaces  | Any           |

| UI Setting                | Description   | Valid Range  | Default Value |
|---------------------------|---|--|---------------|
| <b>Outgoing Interface</b> | <p>Select the outgoing interface for this policy.</p> <div style="border: 1px solid #ccc; background-color: #f9f9f9; padding: 10px; margin-top: 10px;"> <p> <b>Note</b></p> <p>Available interfaces will vary depending on your product model and configuration. Refer to <a href="#">Network Configuration &gt; Network Interfaces</a> for more information about managing your device's interfaces.</p> </div> | Any / Drop-down list of interfaces   | Any           |
| <b>Automation Profile</b> | Select a profile to use for this policy. Each profile will automatically set some of the source and destination settings based on the selected protocol.  | All / TCP / UDP / ICMP / EtherNet/IP I/O (TCP) / EtherNet/IP I/O (UDP) / EtherNet/IP messaging (TCP) / EtherNet IP messaging (UDP) / FF Annunciation (TCP) / FF Annunciation (UDP) / FF Fieldbus Message Specification (TCP) / FF Fieldbus Message Specification (UDP) / FF System Management (TCP) / FF System Management (UDP) / FF LAN Redundancy Port (TCP) / FF LAN Redundancy Port (UDP) / LonWorks (TCP) / LonWorks (UDP) / LonWorks2 (TCP) / LonWorks2 (UDP) / Modbus TCP/IP (TCP) / Modbus TCP/IP (UDP) / PROFINET RT Unicast (TCP) / PROFINET RT Unicast (UDP) / PROFINET RT Multicast (TCP) / PROFINET RT Multicast (UDP) / PROFINET Context Manager (TCP) / PROFINET Context Manager (UDP) / IEC 60870-5-104 process control over IP (TCP) / IEC 60870-5-104 process control over IP (UDP) / IPsec NAT-Traversal (TCP) / IPsec NAT-Traversal (UDP) / DNP3 (TCP) / DNP3 (UDP) / FTP-data (TCP) / FTP-data (UDP) / FTP-control (TCP) / FTP-control (UDP) / SSH (TCP) / SSH (UDP) / Telnet (TCP) / Telnet (UDP) / HTTP (TCP) / HTTP (UDP) / IPsec (TCP) / IPsec (UDP) / L2TP (TCP) / L2TP (UDP) / PPTP (TCP) / PPTP (UDP) / RADIUS (TCP) / RADIUS (UDP) / RADIUS Accounting (TCP) / RADIUS Accounting (UDP) / EtherCAT (TCP) / EtherCAT (UDP) | All           |

| UI Setting  | Description  | Valid Range          | Default Value     |
|---|--|----------------------|-------------------|
| <b>Filter Mode</b>  | Select the filter mode to use for packet filtering.<br><b>IP Address Filter:</b> The policy will filter packets based on IP addresses.   | IP Address Filter    | IP Address Filter |
| <b>Action</b>   | Select the action the firewall should take for traffic that matches this policy.<br><b>Accept:</b> The firewall will accept packets that match the policy.<br><b>Drop:</b> The firewall will drop packets that match the policy.   | Accept / Drop        | ACCEPT            |
| <b>Source IP Address</b>  | Select which source IP addresses this policy will apply to.<br><ul style="list-style-type: none"> <li><b>All:</b> The firewall policy will check all source IP addresses in the packet.</li> <li><b>Single:</b> The firewall policy will check for a single specified source IP address in the packet.</li> <li><b>Range:</b> The firewall policy will check for any source IP addresses in the packet that are within a specified range.</li> </ul> | All / Single / Range | All               |
| <b>Source IP: Start</b><br><b>(If Source IP Address is Single or Range)</b> | Specify the source IP address or the beginning of the source IP address range this policy will apply to.   | Valid IP address     | 0.0.0.0           |
| <b>Source IP: End</b><br><b>(If Source IP Address is Range)</b>             | Specify the end of the source IP address range this policy will apply to.  | Valid IP address     | 0.0.0.0           |

| UI Setting   | Description  | Valid Range   | Default Value |
|--|--|---|---------------|
| <b>Source Port</b><br>(If <b>Automation Profile</b> is <b>TCP</b> or <b>UDP</b> )                    | <p>Select which source ports this policy will apply to.</p> <ul style="list-style-type: none"> <li><b>All:</b> The firewall policy will check all source ports in the packet.</li> <li><b>Single:</b> The firewall policy will check for a single specified source port in the packet.</li> <li><b>Range:</b> The firewall policy will check for any source ports in the packet that are within a specified range.</li> </ul>  | <p>If <b>Automation Profile</b> is <b>TCP</b> or <b>UDP</b>: All / Single / Range</p> <p>For all other <b>Automation Profile</b> options: All</p> | All           |
| <b>Source Port: Start</b><br>(If <b>Source Port</b> is <b>Single</b> or <b>Range</b> )               | Specify the source port or the start of the source port range this policy will apply to.   | 1 to 65535  | N/A           |
| <b>Source Port: End</b><br>(If <b>Source Port</b> is <b>Range</b> )                                  | Specify the end of the source port range this policy will apply to.  | 1 to 65535  | N/A           |
| <b>Destination IP Address</b>  | <p>Select which destination IP addresses this policy will apply to.</p> <ul style="list-style-type: none"> <li><b>All:</b> The firewall policy will check all destination IP addresses in the packet.</li> <li><b>Single:</b> The firewall policy will check for a single specified destination IP address in the packet.</li> <li><b>Range:</b> The firewall policy will check for any destination IP addresses in the packet that are within a specified range.</li> </ul> | All / Single / Range  | All           |
| <b>Destination IP: Start</b><br>(If <b>Destination IP Address</b> is <b>Single</b> or <b>Range</b> ) | Specify the destination IP address or the beginning of the destination IP address range this policy will apply to.   | Valid IP address  | 0.0.0.0       |

| UI Setting   | Description   | Valid Range  | Default Value   |
|--|---|--|---|
| <b>Destination IP: End</b><br>(If Destination IP Address is Range)         | Specify the end of the destination IP address range this policy will apply to.  | Valid IP address   | 0.0.0.0   |
| <b>Destination Port</b>  | <p>Select which destination ports this policy will apply to.</p> <ul style="list-style-type: none"> <li><b>All:</b> The firewall policy will check all destination ports in the packet.</li> <li><b>Single:</b> The firewall policy will check for a single specified destination port in the packet.</li> <li><b>Range:</b> The firewall policy will check for any destination ports in the packet that are within a specified range.</li> </ul> | <p>If <b>Automation Profile</b> is <b>All</b> or <b>ICMP:</b> All</p> <p>If <b>Automation Profile</b> is <b>TCP</b> or <b>UDP:</b> All / Single / Range</p> <p>For all other <b>Automation Profile</b> options: Single</p> | <p>If <b>Automation Profile</b> is <b>All, TCP, UDP,</b> or <b>ICMP:</b> All</p> <p>For all other <b>Automation Profile</b> options: Single</p> |
| <b>Destination Port: Start</b><br>(If Destination Port is Single or Range) | <p>Specify the destination port or the start of the destination port range this policy will apply to.</p> <p>Most of the <b>Automation Profile</b> options will fill in this setting with the default port used for that service. Refer to <a href="#">Ethernet Protocol Default Ports</a> for more information.</p>  | 1 to 65535   | N/A   |
| <b>Destination Port: End</b><br>(If Destination Port is Range)             | Specify the end of the destination port range this policy will apply to.  | 1 to 65535   | N/A   |

## Edit Layer 3 Policy

### Menu Path: Firewall > Layer 3 Policy

Clicking the **Edit** (✎) icon for an entry on the

Unable to render include or excerpt-include. Could not retrieve page.

page will open this dialog box. This dialog lets you edit an existing Layer 3 policy.

Click **APPLY** to save your changes.

### Edit Index 1

Index  
1

Status \*  
Enabled

Name  
IP-Alert  
8 / 64

Severity  
Alert

Log Destination  
Syslog, Local Storage

From Interface  
Any

To Interface  
Any

Automation Profile  
All

Filter Mode  
IP Address Filter

Action Profile  
ACCEPT

Source IP  
All

Source Port  
All

Destination IP  
All

Destination Port  
All

CANCEL APPLY

| UI Setting    | Description   | Valid Range        | Default Value          |
|---------------|---|--------------------|------------------------|
| <b>Index</b>  | Specify the index number for the policy. Policies with a lower index will be processed before policies with a higher index. | 1 to 1024          | Last used index plus 1 |
| <b>Status</b> | Enable or disable the policy.   | Enabled / Disabled | Enabled                |

| UI Setting                | Description   | Valid Range   | Default Value |
|---------------------------|---|---|---------------|
| <b>Name</b>               | Specify a name for the policy.  | 1 to 64 characters  | N/A           |
| <b>Severity</b>           | Select the severity level to assign events for this policy. Refer to <a href="#">Appendix &gt; Severity</a> for more information about severity levels.   | Emergency / Alert / Critical / Error / Warning / Notice / Informational / Debug | Emergency     |
| <b>Log Destination</b>    | Specify where to send firewall event logs. You can select multiple options.<br><br><b>Local Storage:</b> Firewall event logs will be stored on local storage and will show up in the device's Event Log. Refer to <a href="#">Diagnostics &gt; Event Logs and Notifications &gt; Event Log</a> for more information.<br><br><b>Syslog:</b> Firewall event logs will be sent to a syslog server. Refer to <a href="#">Diagnostics &gt; Event Logs and Notifications &gt; Syslog</a> for more information.<br><br><b>Trap:</b> Firewall event notifications will be sent to a trap server. Refer to <a href="#">Diagnostics &gt; SNMP Trap/Inform</a> for more information. | Local Storage / Syslog / Trap   | N/A           |
| <b>Incoming Interface</b> | Select the incoming interface for this policy.<br><br><div style="background-color: #f0f0f0; padding: 10px; border: 1px solid #ccc;"> <p> <b>Note</b></p> <p>Available interfaces will vary depending on your product model and configuration. Refer to <a href="#">Network Configuration &gt; Network Interfaces</a> for more information about managing your device's interfaces.</p> </div>   | Any / Drop-down list of interfaces  | Any           |



| UI Setting                | Description   | Valid Range  | Default Value |
|---------------------------|---|--|---------------|
| <b>Outgoing Interface</b> | <p>Select the outgoing interface for this policy.</p> <div style="border: 1px solid #ccc; background-color: #f9f9f9; padding: 10px; margin-top: 10px;"> <p> <b>Note</b></p> <p>Available interfaces will vary depending on your product model and configuration. Refer to <a href="#">Network Configuration &gt; Network Interfaces</a> for more information about managing your device's interfaces.</p> </div> | Any / Drop-down list of interfaces   | Any           |
| <b>Automation Profile</b> | Select a profile to use for this policy. Each profile will automatically set some of the source and destination settings based on the selected protocol.  | All / TCP / UDP / ICMP / EtherNet/IP I/O (TCP) / EtherNet/IP I/O (UDP) / EtherNet/IP messaging (TCP) / EtherNet IP messaging (UDP) / FF Annunciation (TCP) / FF Annunciation (UDP) / FF Fieldbus Message Specification (TCP) / FF Fieldbus Message Specification (UDP) / FF System Management (TCP) / FF System Management (UDP) / FF LAN Redundancy Port (TCP) / FF LAN Redundancy Port (UDP) / LonWorks (TCP) / LonWorks (UDP) / LonWorks2 (TCP) / LonWorks2 (UDP) / Modbus TCP/IP (TCP) / Modbus TCP/IP (UDP) / PROFINET RT Unicast (TCP) / PROFINET RT Unicast (UDP) / PROFINET RT Multicast (TCP) / PROFINET RT Multicast (UDP) / PROFINET Context Manager (TCP) / PROFINET Context Manager (UDP) / IEC 60870-5-104 process control over IP (TCP) / IEC 60870-5-104 process control over IP (UDP) / IPsec NAT-Traversal (TCP) / IPsec NAT-Traversal (UDP) / DNP3 (TCP) / DNP3 (UDP) / FTP-data (TCP) / FTP-data (UDP) / FTP-control (TCP) / FTP-control (UDP) / SSH (TCP) / SSH (UDP) / Telnet (TCP) / Telnet (UDP) / HTTP (TCP) / HTTP (UDP) / IPsec (TCP) / IPsec (UDP) / L2TP (TCP) / L2TP (UDP) / PPTP (TCP) / PPTP (UDP) / RADIUS (TCP) / RADIUS (UDP) / RADIUS Accounting (TCP) / RADIUS Accounting (UDP) / EtherCAT (TCP) / EtherCAT (UDP) | All           |

| UI Setting  | Description  | Valid Range          | Default Value     |
|---|--|----------------------|-------------------|
| <b>Filter Mode</b>  | Select the filter mode to use for packet filtering.<br><b>IP Address Filter:</b> The policy will filter packets based on IP addresses.   | IP Address Filter    | IP Address Filter |
| <b>Action</b>   | Select the action the firewall should take for traffic that matches this policy.<br><b>Accept:</b> The firewall will accept packets that match the policy.<br><b>Drop:</b> The firewall will drop packets that match the policy.   | Accept / Drop        | ACCEPT            |
| <b>Source IP Address</b>  | Select which source IP addresses this policy will apply to.<br><ul style="list-style-type: none"> <li><b>All:</b> The firewall policy will check all source IP addresses in the packet.</li> <li><b>Single:</b> The firewall policy will check for a single specified source IP address in the packet.</li> <li><b>Range:</b> The firewall policy will check for any source IP addresses in the packet that are within a specified range.</li> </ul> | All / Single / Range | All               |
| <b>Source IP: Start</b><br><b>(If Source IP Address is Single or Range)</b> | Specify the source IP address or the beginning of the source IP address range this policy will apply to.   | Valid IP address     | 0.0.0.0           |
| <b>Source IP: End</b><br><b>(If Source IP Address is Range)</b>             | Specify the end of the source IP address range this policy will apply to.  | Valid IP address     | 0.0.0.0           |

| UI Setting   | Description  | Valid Range   | Default Value |
|--|--|---|---------------|
| <b>Source Port</b><br>(If <b>Automation Profile</b> is <b>TCP</b> or <b>UDP</b> )                    | <p>Select which source ports this policy will apply to.</p> <ul style="list-style-type: none"> <li><b>All:</b> The firewall policy will check all source ports in the packet.</li> <li><b>Single:</b> The firewall policy will check for a single specified source port in the packet.</li> <li><b>Range:</b> The firewall policy will check for any source ports in the packet that are within a specified range.</li> </ul>  | <p>If <b>Automation Profile</b> is <b>TCP</b> or <b>UDP</b>: All / Single / Range</p> <p>For all other <b>Automation Profile</b> options: All</p> | All           |
| <b>Source Port: Start</b><br>(If <b>Source Port</b> is <b>Single</b> or <b>Range</b> )               | Specify the source port or the start of the source port range this policy will apply to.   | 1 to 65535  | N/A           |
| <b>Source Port: End</b><br>(If <b>Source Port</b> is <b>Range</b> )                                  | Specify the end of the source port range this policy will apply to.  | 1 to 65535  | N/A           |
| <b>Destination IP Address</b>  | <p>Select which destination IP addresses this policy will apply to.</p> <ul style="list-style-type: none"> <li><b>All:</b> The firewall policy will check all destination IP addresses in the packet.</li> <li><b>Single:</b> The firewall policy will check for a single specified destination IP address in the packet.</li> <li><b>Range:</b> The firewall policy will check for any destination IP addresses in the packet that are within a specified range.</li> </ul> | All / Single / Range  | All           |
| <b>Destination IP: Start</b><br>(If <b>Destination IP Address</b> is <b>Single</b> or <b>Range</b> ) | Specify the destination IP address or the beginning of the destination IP address range this policy will apply to.   | Valid IP address  | 0.0.0.0       |

| UI Setting   | Description   | Valid Range  | Default Value   |
|--|---|--|---|
| <b>Destination IP: End</b><br>(If Destination IP Address is Range)         | Specify the end of the destination IP address range this policy will apply to.  | Valid IP address   | 0.0.0.0   |
| <b>Destination Port</b>  | <p>Select which destination ports this policy will apply to.</p> <ul style="list-style-type: none"> <li><b>All:</b> The firewall policy will check all destination ports in the packet.</li> <li><b>Single:</b> The firewall policy will check for a single specified destination port in the packet.</li> <li><b>Range:</b> The firewall policy will check for any destination ports in the packet that are within a specified range.</li> </ul> | <p>If <b>Automation Profile</b> is <b>All</b> or <b>ICMP:</b> All</p> <p>If <b>Automation Profile</b> is <b>TCP</b> or <b>UDP:</b> All / Single / Range</p> <p>For all other <b>Automation Profile</b> options: Single</p> | <p>If <b>Automation Profile</b> is <b>All, TCP, UDP,</b> or <b>ICMP:</b> All</p> <p>For all other <b>Automation Profile</b> options: Single</p> |
| <b>Destination Port: Start</b><br>(If Destination Port is Single or Range) | <p>Specify the destination port or the start of the destination port range this policy will apply to.</p> <p>Most of the <b>Automation Profile</b> options will fill in this setting with the default port used for that service. Refer to <a href="#">Ethernet Protocol Default Ports</a> for more information.</p>  | 1 to 65535   | N/A   |
| <b>Destination Port: End</b><br>(If Destination Port is Range)             | Specify the end of the destination port range this policy will apply to.  | 1 to 65535   | N/A   |

## Delete Layer 3 Policy

### Menu Path: Firewall > Layer 3 Policy

You can delete an entry by using the checkboxes to select the entries you want to delete, then clicking the **Delete** (  ) icon.

# Malformed Packets

## Menu Path: Firewall > Malformed Packets

This page lets you configure the Malformed Packets feature, which enables the device to record event logs with a user-specified severity whenever malformed packets are dropped by the system. Click **APPLY** to save your changes.

### Malformed Packets

Status \*  
Disabled ▼

Severity \*  
Emergency ▼

Log Destination ▼

APPLY

| UI Setting             | Description   | Valid Range   | Default Value |
|------------------------|---|---|---------------|
| <b>Status</b>          | Enable or disable recording an event when malformed packets are dropped.  | Enabled / Disabled  | Disabled      |
| <b>Severity</b>        | <a href="#">Select the severity level to assign events for this policy. Refer to the Severity Level List for more information about severity levels.</a>  | Emergency / Alert / Critical / Error / Warning / Notice / Informational / Debug | Emergency     |
| <b>Log Destination</b> | Specify where to send firewall event logs. You can select multiple options.<br><br><b>Local Storage:</b> Firewall event logs will be stored on local storage and will show up in the device's Event Log. Refer to <a href="#">Diagnostics &gt; Event Logs and Notifications &gt; Event Log</a> for more information.<br><br><b>Syslog:</b> Firewall event logs will be sent to a syslog server. Refer to <a href="#">Diagnostics &gt; Event Logs and Notifications &gt; Syslog</a> for more information.<br><br><b>Trap:</b> Firewall event notifications will be sent to a trap server. Refer to <a href="#">Diagnostics &gt; SNMP Trap/Inform</a> for more information. | Local Storage / Syslog / Trap   | N/A           |

# Session Control

## Menu Path: Firewall > Session Control

This page lets you configure session control policies to help protect backend hosts or services and avoid system abnormalities. Click **APPLY** to save your changes.

### Note

If a TCP connection is successfully established, but no data is sent, the connection will be released after 8 seconds. If the interval between the last data transmission for the connection exceeds 300 seconds, the connection will also be released.

### Limitations

You can create up to 64 session control policies.

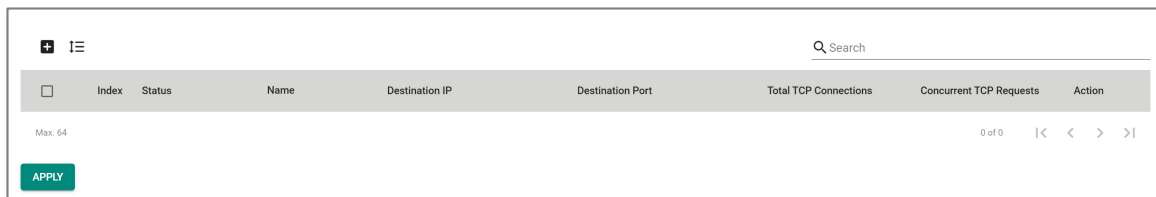

The screenshot shows a table with the following columns: Index, Status, Name, Destination IP, Destination Port, Total TCP Connections, Concurrent TCP Requests, and Action. The table is currently empty. Below the table, there is a search bar, a status indicator 'Max: 64', and a pagination control showing '0 of 0' with navigation arrows. An 'APPLY' button is located at the bottom left of the table area.

| UI Setting                        | Description  |
|-----------------------------------|--|
| <b>Index</b>                      | Shows the index of the policy. The index determines the order for processing policies. |
| <b>Status</b>                     | Shows whether the policy is enabled or disabled.                                       |
| <b>Name</b>                       | Shows the name of the policy.  |
| <b>Destination IP</b>             | Shows the destination IP addresses the policy applies to.                              |
| <b>Destination Port</b>           | Shows the destination ports the policy applies to.                                     |
| <b>Total TCP Connections</b>      | Shows the total number of TCP connections this policy allows.                          |
| <b>Concurrent TCP Connections</b> | Shows the number of concurrent TCP connections this policy allows.                     |

| UI Setting | Description   |
|------------|---|
| Action     | Shows the action that will be taken for applicable traffic. |

## Edit Session Control Policy

### Menu Path: Firewall > Session Control

Clicking the **Edit** (✎) icon for an policy on the **Insert > Path Here** page will open this dialog box. This dialog lets you modify an existing policy. Click **APPLY** to save your changes.

 **Note**

IP Address and Port cannot both be set to Any.

 **Note**

At least one TCP Connection Limitation must be defined.

### Edit Session Control Policy

Index \*  
 1  
 1 - 64

Status \*  
 Enabled

Name \*  
 Test  
 4 / 32

Severity \*  
 Warning

Log Destination  
 Local Storage

Action \*  
 Drop

TCP Destination \*

IP Address \*  
 test

Port \*  
 Any

TCP Connection Limitation \* i



Total TCP Connections  
 50  
 1 - 9000 connections

Concurrent TCP Reques...  
 50  
 1 - 512 connections/s

CANCEL APPLY

| UI Setting    | Description  | Valid Range        | Default Value          |
|---------------|--|--------------------|------------------------|
| <b>Index</b>  | Specify the index number for the policy. The index determines the order for processing policies. | 1 to 64            | Last used index plus 1 |
| <b>Status</b> | Enable or disable the policy.  | Enabled / Disabled | Enabled                |
| <b>Name</b>   | Specify a name for the policy.   | 1 to 32 characters | N/A                    |



| UI Setting                    | Description   | Valid Range   | Default Value |
|-------------------------------|---|---|---------------|
| <b>Severity</b>               | Select the severity level to assign events for this policy. Refer to the <a href="#">Severity Level List</a> for more information about severity levels.  | Emergency / Alert / Critical / Error / Warning / Notice / Informational / Debug | N/A           |
| <b>Log Destination</b>        | Specify where to send firewall event logs. You can select multiple options.<br><b>Syslog:</b> Firewall event logs will be sent to a syslog server. Refer to <a href="#">Diagnostics &gt; Event Logs and Notifications &gt; Syslog</a> for more information.<br><b>Trap:</b> Firewall event notifications will be sent to a trap server. Refer to <a href="#">Diagnostics &gt; SNMP Trap/Inform</a> for more information.<br><b>Local Storage:</b> Firewall event logs will be stored on local storage and will show up in the device's Event Log. Refer to <a href="#">Diagnostics &gt; Event Logs and Notifications &gt; Event Log</a> for more information. | Syslog / Trap / Local Storage   | N/A           |
| <b>Action</b>                 | Select the action the firewall should take for traffic that matches this policy.<br><b>Monitor:</b> The firewall will monitor packets that match the policy.<br><b>Drop:</b> The firewall will drop packets that match the policy.  | Monitor / Drop  | Drop          |
| <b>IP Address</b>             | Select the IP addresses this policy will apply to. Select <b>Any</b> to check traffic from all IP addresses, or select a pre-defined object. You can also click the Add (  ) icon to create a new IP Address and Subnet object.<br>Refer to <a href="#">Create Object</a> for more information.  | Any / Drop-down list of IP Address and Subnet objects                           | N/A           |
| <b>Port</b>                   | Select the ports this policy will apply to. Select <b>Any</b> to check traffic from all ports, or select a pre-defined object. You can also click the Add (  ) icon to create a new User-defined Service object.<br>Refer to <a href="#">Create Object</a> for more information.   | Any / Drop-down list of port-based User-defined Service objects                 | N/A           |
| <b>Total TCP Connection</b>   | Specify the total allowed number of TCP connections.  | 1 to 9000   | N/A           |
| <b>Concurrent TCP Request</b> | Specify the total allowed number of concurrent TCP requests.  | 1 to 512  | N/A           |

## Create Session Control Policy

### Menu Path: Firewall > Session Control

Clicking the **Add (+)** icon on the **Firewall > Session Control** page will open this dialog box. This dialog lets you create a new policy. Click **CREATE** to save your changes and add the new policy.

#### **Note**

IP Address and Port cannot both be set to Any.

#### **Note**

At least one TCP Connection Limitation must be defined.

### Create Session Control Policy

Index \*  
1

1 - 64

Status \*  
Enabled

Name \*  
0 / 32

Severity \*  
Warning

Log Destination  
Local Storage

Action \*  
Drop

TCP Destination \*

IP Address \* 

Port \* 

TCP Connection Limitation \* 

| Total TCP Connections   | Concurrent TCP Reques... |
|-------------------------|--------------------------|
| 1 - 9000<br>connections | 1 - 512<br>connections/s |

CANCEL CREATE

| UI Setting                  | Description   | Valid Range   | Default Value          |
|-----------------------------|---|---|------------------------|
| <b>Index</b>                | Specify the index number for the policy. The index determines the order for processing policies.  | 1 to 64   | Last used index plus 1 |
| <b>Status</b>               | Enable or disable the policy.   | Enabled / Disabled  | Enabled                |
| <b>Name</b>                 | Specify a name for the policy.  | 1 to 32 characters  | N/A                    |
| <b>Severity</b>             | Select the severity level to assign events for this policy. Refer to the <a href="#">Severity Level List</a> for more information about severity levels.  | Emergency / Alert / Critical / Error / Warning / Notice / Informational / Debug | N/A                    |
| <b>Log Destination</b>      | Specify where to send firewall event logs. You can select multiple options.<br><b>Syslog:</b> Firewall event logs will be sent to a syslog server. Refer to <a href="#">Diagnostics &gt; Event Logs and Notifications &gt; Syslog</a> for more information.<br><b>Trap:</b> Firewall event notifications will be sent to a trap server. Refer to <a href="#">Diagnostics &gt; SNMP Trap/Inform</a> for more information.<br><b>Local Storage:</b> Firewall event logs will be stored on local storage and will show up in the device's Event Log. Refer to <a href="#">Diagnostics &gt; Event Logs and Notifications &gt; Event Log</a> for more information. | Syslog / Trap / Local Storage   | N/A                    |
| <b>Action</b>               | Select the action the firewall should take for traffic that matches this policy.<br><b>Monitor:</b> The firewall will monitor packets that match the policy.<br><b>Drop:</b> The firewall will drop packets that match the policy.  | Monitor / Drop  | Drop                   |
| <b>IP Address</b>           | Select the IP addresses this policy will apply to. Select <b>Any</b> to check traffic from all IP addresses, or select a pre-defined object. You can also click the Add (+) icon to create a new IP Address and Subnet object.<br>Refer to <a href="#">Create Object</a> for more information.  | Any / Drop-down list of IP Address and Subnet objects                           | N/A                    |
| <b>Port</b>                 | Select the ports this policy will apply to. Select <b>Any</b> to check traffic from all ports, or select a pre-defined object. You can also click the Add (+) icon to create a new User-defined Service object.<br>Refer to <a href="#">Create Object</a> for more information.   | Any / Drop-down list of port-based User-defined Service objects                 | N/A                    |
| <b>Total TCP Connection</b> | Specify the total allowed number of TCP connections.  | 1 to 9000   | N/A                    |

| UI Setting                    | Description  | Valid Range | Default Value |
|-------------------------------|--|-------------|---------------|
| <b>Concurrent TCP Request</b> | Specify the total allowed number of concurrent TCP requests. | 1 to 512    | N/A           |

## Delete Session Control Policy

### Menu Path: Firewall > Session Control

You can delete a policy by using the checkboxes to select the entries you want to delete, then clicking the **Delete** (🗑️) icon.

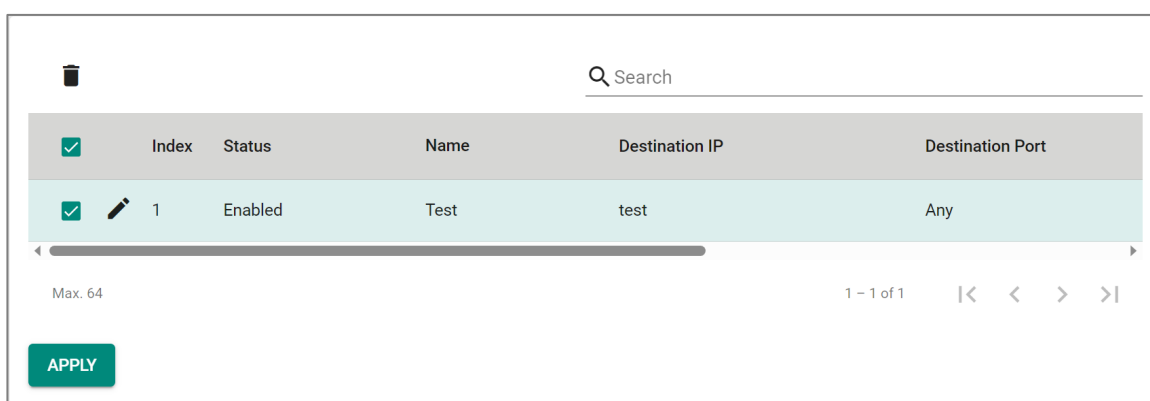

## Reorder Session Control Policies

### Menu Path: Firewall > Session Control

You can reorder policies by clicking the **Reorder Priorities** (⇅) icon, moving the entries into the order you want, then clicking the **Reorder Priorities** (⇅) icon again.

Reordering policies affects the order used to process the policies.

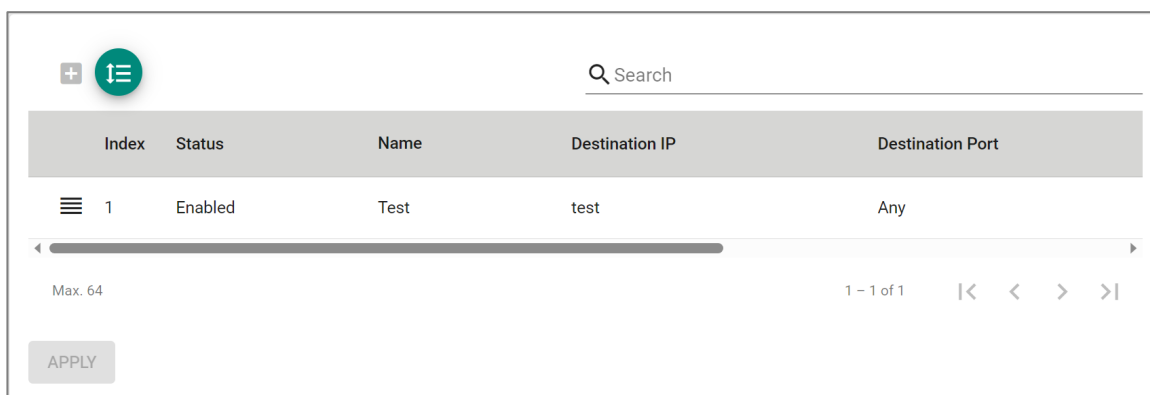

# DoS Policy

## Menu Path: Firewall > DoS Policy

This page lets you configure Denial of Service (DoS) protection features. You can configure different DoS functions for detecting abnormal packet formats or traffic flows, allowing your device to drop packets when it detects an abnormal packet format or identifies unusual traffic conditions.

## DoS Log Settings

**DoS Log Settings**

Log \* Severity \*

Disabled ▼ Emergency ▼ Log Destination ▼

APPLY

| UI Setting             | Description   | Valid Range   | Default Value |
|------------------------|---|---|---------------|
| <b>Log</b>             | Enable or disable DoS event logs.   | Enabled / Disabled  | Disabled      |
| <b>Severity</b>        | <a href="#">Select the severity level to assign to DoS-related events. Refer to the Severity Level List for more information about severity levels.</a>   | Emergency / Alert / Critical / Error / Warning / Notice / Informational / Debug | Emergency     |
| <b>Log Destination</b> | Specify where to send firewall event logs. You can select multiple options.<br><br><b>Syslog:</b> Firewall event logs will be sent to a syslog server. Refer to <a href="#">Diagnostics &gt; Event Logs and Notifications &gt; Syslog</a> for more information.<br><br><b>Trap:</b> Firewall event notifications will be sent to a trap server. Refer to <a href="#">Diagnostics &gt; SNMP Trap/Inform</a> for more information.<br><br><b>Local Storage:</b> Firewall event logs will be stored on local storage and will show up in the device's Event Log. Refer to <a href="#">Diagnostics &gt; Event Logs and Notifications &gt; Event Log</a> for more information. | Local Storage / Syslog / Trap   | N/A           |

# DoS Settings

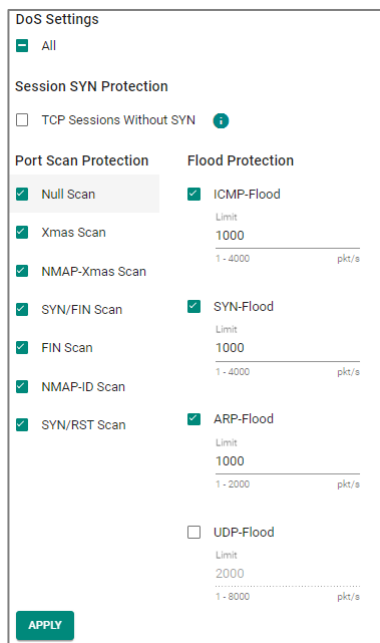

| UI Setting                    | Description  | Valid Range  | Default Value           |
|-------------------------------|--|--|-------------------------|
| <b>DoS Settings</b>           | Toggle all DoS protection methods on or off.   | All  | N/A                     |
| <b>Session SYN Protection</b> | <p>Enable or disable session SYN protection methods.</p> <p><b>TCP Sessions Without SYN:</b> When enabled, this function will verify the SYN state within the TCP flag when establishing TCP sessions.</p> <p>If the SYN tag is missing in the initial packet, the system will drop the packet and block the connection. Running TCP sessions will be re-established to perform the check.</p> <div style="background-color: #fff9c4; padding: 10px; margin-top: 10px;"> <p><b>⚠ Warning</b></p> <p>When NAT is enabled for asymmetric network architectures, it is strongly advised to keep <b>TCP Sessions Without SYN</b> disabled to avoid unexpected disconnections.</p> </div> | TCP Sessions Without SYN   | Checked for all methods |
| <b>Port Scan Protection</b>   | Enable or disable port-scan protection methods.  | Null Scan / Xmas Scan / NMAP-Xmas Scan / SYN/FIN Scan / FIN Scan / NMAP-ID Scan / SYN/RST Scan | Enabled for all methods |

| UI Setting              | Description  | Valid Range  | Default Value  |
|-------------------------|--|--|--|
| <b>Flood Protection</b> | <p>Enable or disable flood protection methods. When enabling a protection method, specify the limit in packets/second that will trigger the corresponding flood protection.</p> <div style="background-color: #f0f0f0; padding: 10px; margin: 10px 0;"> <p><b>Note</b></p> <p>If <b>Accept All LAN Port Connections</b> is enabled in <b>Trusted Access</b>, <b>Flood Protection</b> will be disabled.</p> <p>Refer to <a href="#">Security &gt; Device Security &gt; Trusted Access</a> for more information.</p> </div> <div style="background-color: #f0f0f0; padding: 10px; margin: 10px 0;"> <p><b>Note</b></p> <p>For Flood Protection, each interface has an independent limit which does not affect the limits of other interfaces.</p> </div> | ICMP-Flood (1 to 4000) / SYN-Flood (1 to 4000) / ARP-Flood (1 to 2000) / UDP-Flood (1 to 8000) | <p>Enabled with Limit set to 1000 for ICMP-Flood, SYN-Flood, ARP-Flood</p> <p>Disabled with Limit set to 0 for UDP-Flood</p> |

## Soft Lockdown Mode

### Menu Path: Firewall > Soft Lockdown Mode

This page lets you configure Soft Lockdown Mode for your device. For more information on how this feature works, refer to [Soft Lockdown](#).

#### **Note**

Soft Lockdown Mode is a feature designed for railway applications and is only supported by the TN-4900 Series.

**Note**

In addition to the criteria defined in these settings, the device will enter Soft Lockdown Mode if any enabled critical service is no longer alive, and all enabled critical services must be alive to leave Soft Lockdown Mode.

The critical services that apply to Soft Lockdown Mode are as follows:

- DHCP Server (refer to Network Service > DHCP Server)
- DHCP Relay Agent (refer to Network Service > DHCP Server - DHCP Relay Agent)
- SNMP Server (refer to SNMP)
- Turbo Ring V2 (refer to Redundancy > Layer 2 Redundancy > Turbo Ring V2)

**Note**

If Soft Lockdown Mode and DHCP Server are both enabled, make sure at least one LAN interface's IP is within the DHCP server pool and at least one physical port is assigned to this LAN interface.

### Soft Lockdown Mode

**Soft Lockdown Status**

Status  
Not in Soft Lockdown Mode

Enable \*  
Disabled

Interface \*

CPU utilization threshold \*  
70  
1 - 90 %

Free memory space threshold \*  
20  
1 - 50 %

Status monitoring interval \*  
1  
1 - 5 sec.

Failure cycles to enter lockdown mode \*  
5  
3 - 10

Normal cycles to leave lockdown mode \*  
5  
3 - 10

**APPLY**



| UI Setting                                   | Description  | Valid Range                  | Default Value |
|--|--|------------------------------|---------------|
| <b>Enable</b>                                | Enable/Disable use of the Soft Lockdown Mode feature.  | Enabled/Disabled             | Disable       |
| <b>Interface</b>                             | Specify which interface Soft Lockdown Mode will apply to. When in Soft Lockdown Mode, all traffic on this interface (both ingress and egress) will be blocked. | Drop-down list of interfaces | N/A           |
| <b>CPU utilization threshold</b>             | Specify the maximum CPU utilization % allowed. If the CPU utilization % goes over this threshold, a failure will be triggered for the current cycle.           | 1 to 90%                     | 70            |
| <b>Free memory space threshold</b>           | Specify the minimum free memory % allowed. If the free memory % goes below this threshold, a failure will be triggered for the current cycle.                  | 1 to 50%                     | 20            |
| <b>Status monitoring interval</b>            | Specify a cycle time in seconds to monitor CPU and memory usage for failure detection.   | 1 to 5 seconds               | 1             |
| <b>Failure cycles to enter lockdown mode</b> | Specify the number of consecutive cycles with failures allowed before entering soft lockdown mode.   | 3 to 10                      | 5             |
| <b>Normal cycles to leave lockdown mode</b>  | Specify the required number of normal consecutive cycles without failures to leave soft lockdown mode.   | 3 to 10                      | 5             |

## Advanced Protection

### Menu Path: Firewall > Advanced Protection

This section lets you monitor and configure your device's advanced firewall features.

This section includes these pages:

- Dashboard
- Configuration
- Protocol Filter Policy
- ADP
- IPS

# Dashboard

## Menu Path: Firewall > Advanced Protection > Dashboard

This page lets you see an overview of your firewall's advanced protection activity with real-time event counters.

### Note

Please note that available status displays may vary depending on the product and model, and whether an IPS license is installed or not.

## Information

This display shows the versions of the installed firewall engines and security packages currently installed on the device, as well as whether various functions are enabled.

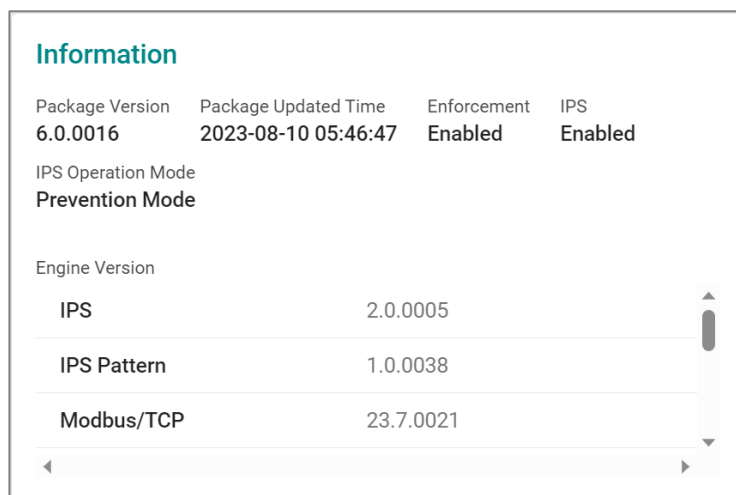

The screenshot shows a panel titled "Information" with the following data:

| Package Version | Package Updated Time | Enforcement | IPS     |
|-----------------|----------------------|-------------|---------|
| 6.0.0016        | 2023-08-10 05:46:47  | Enabled     | Enabled |

Below this, it shows "IPS Operation Mode" set to "Prevention Mode".

Under "Engine Version", there is a scrollable list:

| Engine Name | Version   |
|-------------|-----------|
| IPS         | 2.0.0005  |
| IPS Pattern | 1.0.0038  |
| Modbus/TCP  | 23.7.0021 |

| UI Setting                  | Description  |
|-----------------------------|--|
| <b>Package Version</b>      | Shows the version of the current Network Security Package installed on the device. |
| <b>Package Updated Time</b> | Shows when the current Network Security Package was installed.                     |
| <b>Enforcement</b>          | Shows whether Protocol Filtering is enabled.                                       |
| <b>IPS</b>                  | Shows whether IPS is enabled.  |

| UI Setting                | Description   |
|---------------------------|---|
| <b>IPS Operation Mode</b> | Shows which operation mode IPS is using.                |
| <b>Engine Version</b>     | Shows the versions of the different engines being used. |

**Note**

Starting from v9.0 of the Network Security Package, when the IPS license expires, existing IPS patterns can still be used for IPS protection. However, the IPS patterns will not be updated and will remain at their current versions when you update the Network Security Package.

## Intrusion Prevention System (IPS)

This display shows the current number of Intrusion Prevention System (IPS) events. Clicking on an item will take you to a filtered view of the IPS event log. Refer to [Diagnostics > Event Logs and Notifications > Event Log - Firewall Log](#) for more information.

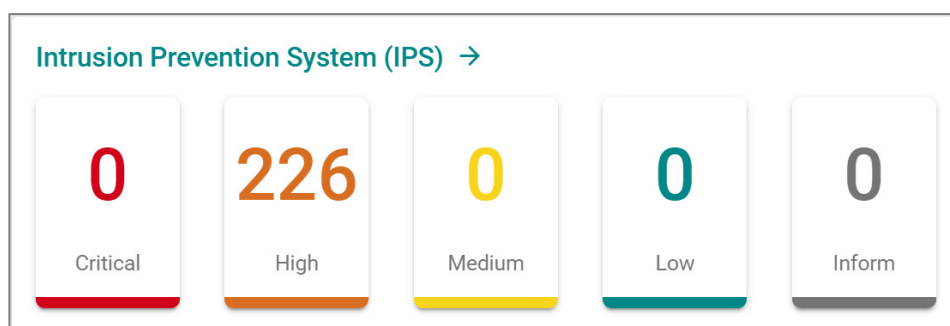

## ADP

This display shows the current number of Anomaly Detection and Prevention (ADP) events. Clicking on an item will take you to the ADP event log. Refer to [Diagnostics > Event Logs and Notifications > Event Log - Firewall Log](#) for more information.

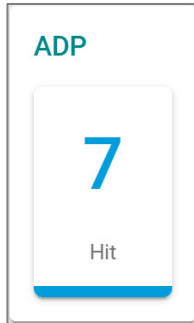

## Enforcement

This display shows the current number of industrial protocol events. Clicking on an item will take you to a filtered view of the Protocol Filter Policy event log. Refer to [Diagnostics > Event Logs and Notifications > Event Log - Firewall Log](#) for more information.

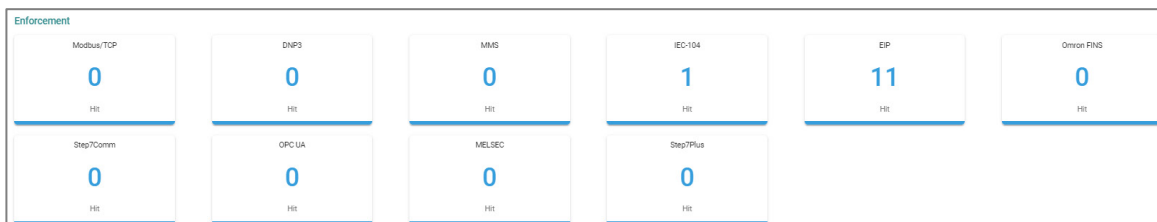

## Configuration

**Menu Path: Firewall > Advanced Protection > Configuration**

This page lets you configure your application firewall's advanced protection settings.

This page includes these tabs:

- Global Settings
- Protocol Filter Object
- Protocol Filter Profile

## Configuration - Global Settings

**Menu Path: Firewall > Advanced Protection > Configuration - Global Settings**

This page lets you configure global settings for your application firewall's advanced protection features. You can also back up and restore your advanced protection settings on this page.

### Backup/Restore

| UI Setting  | Description   | Valid Range  | Default Value |
|---|---|--|---------------|
| <b>Backup/Restore</b>   | <p>Select which settings you want to back up or restore. If you want to back up your settings, click <b>BACK UP</b>.</p> <p><b>Configuration:</b> Back up/restore all settings on the <b>Firewall &gt; Advanced Protection &gt; Configuration</b> page.</p> <p><b>Protocol Filter Policy:</b> Back up/restore all policies on the <b>Firewall &gt; Advanced Protection &gt; Protocol Filter Policy</b> page.</p> <p><b>Debug Information:</b> Back up debug information for your firewall's advanced protection features.</p> | Configuration / Protocol Filter Policy / Debug Information | Configuration |
| <b>Select File</b><br><b>(if Backup/Restore is Configuration or Protocol Filter Policy)</b> | <p>If you want to restore settings, click this field and select the settings file from your local computer, then click <b>RESTORE</b>.</p>  | N/A  | N/A           |

## Global Settings

### Note

Available settings will vary depending on your product model and whether an active IPS license is installed.

**Global Settings**

**Intrusion Prevention System (IPS)**

IPS \* IPS Operation Mode \*  
 Disabled Prevention Mode

---

**Enforcement**

Enforcement \* Action \*  
 Enabled Reset

---

Modbus/TCP Firewall \* Modbus/TCP ADP \* Modbus/TCP Service Port \*  
 Enabled Enabled 502  
1 - 65535, allow comma(,)

DNP3 Firewall \* DNP3 ADP \* DNP3 Service Port \*  
 Enabled Enabled 20000  
1 - 65535, allow comma(,)

MMS Firewall \* MMS Service Port \*  
 Enabled 102  
1 - 65535, allow comma(,)

IEC-104 Firewall \* IEC-104 ADP \* IEC-104 Service Port \*  
 Enabled Enabled 2404  
1 - 65535, allow comma(,)

EIP Firewall \* EIP ADP \* EIP Service Port \*  
 Enabled Enabled 44818  
1 - 65535, allow comma(,)

Omron FINS Firewall \* Omron FINS ADP \* Omron FINS Service Port \*  
 Enabled Enabled 9600  
1 - 65535, allow comma(,)

Step7Comm Firewall \* Step7Comm ADP \* Step7Comm Service Port \*  
 Enabled Enabled 102  
1 - 65535, allow comma(,)

OPC UA Firewall \* OPC UA ADP \* OPC UA Service Port \*  
 Enabled Enabled 4840  
1 - 65535, allow comma(,)

MELSEC Firewall \* MELSEC ADP \* MELSEC Service Port \*  
 Enabled Enabled 8196  
1 - 65535, allow comma(,)

Step7Plus Firewall \* Step7Plus ADP \* Step7Plus Service Port \*  
 Enabled Enabled 102  
1 - 65535, allow comma(,)

---

**Troubleshooting**

Debug Logging \*  
 Disabled

**APPLY**

## Intrusion Prevention System (IPS)

### Note

Available settings will vary depending on your product model.

| UI Setting | Description  | Valid Range        | Default Value |
|------------|--|--------------------|---------------|
| <b>IPS</b> | Enable or disable intrusion prevention system (IPS) functionality. | Enabled / Disabled | Enabled       |

| UI Setting                | Description                    | Valid Range                      | Default Value   |
|---------------------------|--------------------------------|----------------------------------|-----------------|
| <b>IPS Operation Mode</b> | Select the IPS operation mode. | Prevention Mode / Detection Mode | Prevention Mode |

## Enforcement

| UI Setting                     | Description  | Valid Range              | Default Value |
|--------------------------------|--|--------------------------|---------------|
| <b>Enforcement</b>             | Enable or disable protocol filtering.  | Enabled / Disabled       | Enabled       |
| <b>Action</b>                  | <p>Select the default action of the protocol filter when enforcement is enabled.</p> <div style="background-color: #f0f0f0; padding: 5px; margin: 5px 0;"> <p> <b>Note</b></p> <p>The Event Log (Firewall Log) will display Policy ID '99999' when this default action is activated.</p> </div> <p><b>Accept:</b> The firewall will accept packets when no defined Protocol Filter Policy matches. With this setting, no logs are recorded.</p> <p><b>Monitor:</b> The firewall will accept packets when no defined Protocol Filter Policy matches. With this setting, each packet of an identified application protocol will have a corresponding Event Log entry.</p> <p><b>Reset:</b> The firewall will drop packets when no defined Protocol Filter Policy matches. With this setting, only the first packet of an identified application protocol will be recorded in Event Log.</p> | Accept / Monitor / Reset | Reset         |
| <b>Modbus/TCP Firewall</b>     | Enable or disable the Modbus/TCP protocol filter engine.   | Enabled / Disabled       | Enabled       |
| <b>Modbus/TCP ADP</b>          | Enable or disable ADP for Modbus/TCP traffic.  | Enabled / Disabled       | Enabled       |
| <b>Modbus/TCP Service Port</b> | Specify the service port for Modbus/TCP traffic. You can specify multiple ports by separating them with a comma.   | 1 to 65535               | 502           |
| <b>DNP3 Firewall</b>           | Enable or disable the DNP3 protocol filter engine.   | Enabled / Disabled       | Enabled       |
| <b>DNP3 ADP</b>                | Enable or disable ADP for DNP3 traffic.  | Enabled / Disabled       | Enabled       |
| <b>DNP3 Service Port</b>       | Specify the service port for DNP3 traffic. You can specify multiple ports by separating them with a comma.   | 1 to 65535               | 20000         |

| UI Setting                     | Description  | Valid Range        | Default Value |
|--------------------------------|--|--------------------|---------------|
| <b>MMS Firewall</b>            | Enable or disable the MMS protocol filter engine.  | Enabled / Disabled | Enabled       |
| <b>MMS Service Port</b>        | Specify the service port for MMS traffic. You can specify multiple ports by separating them with a comma.        | 1 to 65535         | 102           |
| <b>IEC-104 Firewall</b>        | Enable or disable the IEC-104 protocol filter engine.  | Enabled / Disabled | Enabled       |
| <b>IEC-104 ADP</b>             | Enable or disable ADP for IEC-104 traffic.   | Enabled / Disabled | Enabled       |
| <b>IEC-104 Service Port</b>    | Specify the service port for IEC-104 traffic. You can specify multiple ports by separating them with a comma.    | 1 to 65535         | 2404          |
| <b>GOOSE Firewall</b>          | Enable or disable the GOOSE protocol filter engine.  | Enabled / Disabled | Enabled       |
| <b>EIP Firewall</b>            | Enable or disable the EIP protocol filter engine.  | Enabled / Disabled | Enabled       |
| <b>EIP ADP</b>                 | Enable or disable ADP for EIP traffic.   | Enabled / Disabled | Enabled       |
| <b>EIP Service Port</b>        | Specify the service port for EIP traffic. You can specify multiple ports by separating them with a comma.        | 1 to 65535         | 44818         |
| <b>Omron FINS Firewall</b>     | Enable or disable the Omron FINS protocol filter engine.   | Enabled / Disabled | Enabled       |
| <b>Omron FINS ADP</b>          | Enable or disable ADP for Omron FINS traffic.  | Enabled / Disabled | Enabled       |
| <b>Omron FINS Service Port</b> | Specify the service port for Omron FINS traffic. You can specify multiple ports by separating them with a comma. | 1 to 65535         | 9600          |
| <b>Step7Comm Firewall</b>      | Enable or disable the Step7Comm protocol filter engine.  | Enabled / Disabled | Enabled       |
| <b>Step7Comm ADP</b>           | Enable or disable ADP for Step7Comm traffic.   | Enabled / Disabled | Enabled       |
| <b>Step7Comm Service Port</b>  | Specify the service port for Step7Comm traffic. You can specify multiple ports by separating them with a comma.  | 1 to 65535         | 102           |
| <b>TRDP Firewall</b>           | Enable or disable the TRDP protocol filter engine.   | Enabled / Disabled | Enabled       |



| UI Setting                    | Description   | Valid Range        | Default Value |
|-------------------------------|---|--------------------|---------------|
| <b>TRDP Service Port</b>      | Specify the service port for TRDP traffic. You can specify multiple ports by separating them with a comma.      | 1 to 65535         | 17224, 17225  |
| <b>OPC UA Firewall</b>        | Enable or disable the OPC UA protocol filter engine.  | Enabled / Disabled | Enabled       |
| <b>OPC UA ADP</b>             | Enable or disable ADP for OPC UA traffic.   | Enabled / Disabled | Enabled       |
| <b>OPC UA Service Port</b>    | Specify the service port for OPC UA traffic. You can specify multiple ports by separating them with a comma.    | 1 to 65535         | 4840          |
| <b>MELSEC Firewall</b>        | Enable or disable the MELSEC protocol filter engine.  | Enabled / Disabled | Enabled       |
| <b>MELSEC ADP</b>             | Enable or disable ADP for MELSEC traffic.   | Enabled / Disabled | Enabled       |
| <b>MELSEC Service Port</b>    | Specify the service port for MELSEC traffic. You can specify multiple ports by separating them with a comma.    | 1 to 65535         | 8196          |
| <b>Step7Plus Firewall</b>     | Enable or disable the Step7Plus protocol filter engine.   | Enabled / Disabled | Enabled       |
| <b>Step7Plus ADP</b>          | Enable or disable ADP for Step7Plus traffic.  | Enabled / Disabled | Enabled       |
| <b>Step7Plus Service Port</b> | Specify the service port for Step7Plus traffic. You can specify multiple ports by separating them with a comma. | 1 to 65535         | 102           |

## Troubleshooting

| UI Setting           | Description  | Valid Range        | Default Value |
|----------------------|--|--------------------|---------------|
| <b>Debug Logging</b> | Enable or disable debug logging for troubleshooting. | Enabled / Disabled | Disabled      |

## Protocol Filter Object

### Menu Path: Firewall > Advanced Protection > Configuration - Protocol Filter Object











This page lets you create and manage protocol filter objects, which can simplify creation and maintenance of protocol filter policies.

#### Note

Available protocols may vary across different product models and versions.

#### Limitations

You can create up to 64 protocol filter objects.

| <input type="checkbox"/> | Protocol Filter Object  | Category   | Protocol Filter Profile |
|--------------------------|---|------------|-------------------------|
| <input type="checkbox"/> |  Modbus_readwrite_test | Modbus/TCP | ReadWrite               |
| <input type="checkbox"/> |  Modbus_Read_Only      | Modbus/TCP | ReadOnly                |
| <input type="checkbox"/> |  MOXA_test             | Modbus/TCP | ReadOnly                |
| <input type="checkbox"/> |  Modbus_Manual         | Modbus/TCP | Manual                  |
| <input type="checkbox"/> |  Modbus_customized     | Modbus/TCP | Manual                  |
| <input type="checkbox"/> |  test                  | Modbus/TCP | Manual                  |
| <input type="checkbox"/> |  Modbus_write          | Modbus/TCP | WriteOnly               |
| <input type="checkbox"/> |  EIP_Test              | EIP        | JasonTest               |
| <input type="checkbox"/> |  Omron_Test            | Omron FINS | Manual                  |
| <input type="checkbox"/> |  FINSTest              | Step7Comm  | Manual                  |

Max. 64 1 - 10 of 10 < >

| UI Setting                    | Description                                |
|-------------------------------|--|
| <b>Protocol Filter Object</b> | Shows the name of the object               |
| <b>Category</b>               | Shows the protocol category of the object. |

| UI Setting                     | Description  |
|--------------------------------|--|
| <b>Protocol Filter Profile</b> | Shows which protocol filter profile the object uses. |

## Protocol Filter Object - Create Object

### Menu Path: Firewall > Advanced Protection > Configuration - Protocol Filter Object

Clicking the **Add (+)** icon on the **Firewall > Advanced Protection > Configuration - Protocol Filter Object** page will open this dialog box. This dialog lets you create a protocol filter object. Click **CREATE** to save your changes and add the new object.

### Create Object - Modbus/TCP

If **Modbus/TCP** is selected for the **Category**, these settings will appear.

| UI Setting  | Description                    | Valid Range        | Default Value |
|-------------|--------------------------------|--------------------|---------------|
| <b>Name</b> | Specify a name for the object. | 1 to 64 characters | N/A           |

| UI Setting                     | Description   | Valid Range   | Default Value  |
|--------------------------------|---|---|--|
| <b>Category</b>                | <p>Select a protocol for this object.</p> <div style="border: 1px solid #ccc; background-color: #f9f9f9; padding: 5px; margin-top: 10px;"> <p> <b>Note</b></p> <p>Available settings will vary depending on your product model.</p> </div>   | Modbus/TCP / DNP3 / MMS / IEC-104 / EIP / Omron FINS / Step7Comm / TRDP / OPC UA / MELSEC / Step7Plus | N/A  |
| <b>Slave ID</b>                | <p>Specify the Modbus slave ID. Leave this field blank to represent any ID.</p> <div style="border: 1px solid #ccc; background-color: #f9f9f9; padding: 5px; margin-top: 10px;"> <p>The Slave ID is used to identify Modbus devices. This ID can be used to communicate via devices such as bridges and gateways which use a single IP address to support multiple independent end units.</p> </div>  | 0 to 255 / 0x00 to 0xFF   | Any  |
| <b>Protocol Filter Profile</b> | <p>Select preset protocol filter profile or a user-configured protocol filter profile to use for this protocol filter object.</p> <p><b>Read Only:</b> Use a set of commonly used function codes associated with read-only access.</p> <p><b>Write Only:</b> Use a set of commonly used function codes associated with write-only access.</p> <p><b>Read/Write:</b> Use a set of commonly used function codes associated with read/write access.</p> <p><b>Manual:</b> Manually enter the settings for this object.</p> <p>Refer to <a href="#">Firewall &gt; Advanced Protection &gt; Configuration - Protocol Filter Profile</a> for more information on creating protocol filter profiles.</p> | Read Only / Write Only / Read/Write / Drop-down list of related protocol filter profiles / Manual     | N/A  |
| <b>Function Code</b>           | <p>Shows which function codes will be used for the object, based on the selected <b>Protocol Filter Profile</b>.</p> <p>If <b>Manual</b> is selected for the <b>Protocol Filter Profile</b>, select which function codes to use for this object. You can select multiple options.</p>   | Drop-down list of function codes  | Depends on the selected <b>Protocol Filter Profile</b> |

| UI Setting   | Description  | Valid Range                            | Default Value |
|--|--|--|---------------|
| <b>PLC Address Base 1</b><br>(if only one Function Code is selected) | Select whether the PLC's starting address should start from 0x00 or 0x01. This should be set based on your PLCs to ensure DPI filters the correct addresses and values.<br><b>Enabled:</b> The PLC's starting address starts at 0x01.<br><b>Disabled:</b> The PLC's starting address starts at 0x00. | Enabled / Disabled                     | Disabled      |
| <b>Filter Type</b><br>(if only one Function Code is selected)        | Select the filter type to use.<br><b>None:</b> Filter traffic by specified function codes.<br><b>Address Range:</b> Filter traffic by specified PLC register addresses.<br><b>Data Value:</b> Filter the traffic by specified data values in the registers.  | None / Address Range / Data Value      | None          |
| <b>Address Range</b><br>(if Filter Type is Address Range)            | Define the address range to use for the filter. You can enter the address range in decimal or hexadecimal format.  | 0 to 65535 / 0x0000 to 0xFFFF          | N/A           |
| <b>Start Address</b><br>(if Filter Type is Data Value)               | Specify the starting address for the PLC register address. You can enter the addresss in decimal or hexadecimal format.  | 0 to 65535 / 0x0000 to 0xFFFF          | N/A           |
| <b>Value</b><br>(if Filter Type is Data Value)                       | Specify a data value to filter for. You can enter up to 16 bits (2 bytes) of binary data for the data value.   | 0 to 1111111111111111<br>(binary data) | N/A           |

### Create Object - DNP3

If **DNP3** is selected for the **Category**, these settings will appear.

**Create Object**

Name \*  0 / 64

Category \*  
DNP3 ▼

Protocol Filter Profile \*  
Manual ▼

Source Address  
0 - 65535 or 0x0000 - 0xFFFF

Destination Address  
0 - 65535 or 0x0000 - 0xFFFF

Application Function Code \* ▼

Group  
0 - 255 or 0x00 - 0xFF

Variation  
0 - 255 or 0x00 - 0xFF

CANCEL CREATE

| UI Setting                     | Description   | Valid Range   | Default Value  |
|--------------------------------|---|---|--|
| <b>Name</b>                    | Specify a name for the object.  | 1 to 64 characters  | N/A  |
| <b>Category</b>                | Select a protocol for this object. <div style="background-color: #f0f0f0; padding: 5px; margin-top: 10px;"> <p><b>Note</b></p> <p>Available settings will vary depending on your product model.</p> </div>  | Modbus/TCP / DNP3 / MMS / IEC-104 / EIP / Omron FINS / Step7Comm / TRDP / OPC UA / MELSEC / Step7Plus | N/A  |
| <b>Protocol Filter Profile</b> | Select a user-configured protocol filter profile to use for this protocol filter object. <p><b>Manual:</b> Manually enter the settings for this object.</p> <p>Refer to <a href="#">Firewall &gt; Advanced Protection &gt; Configuration - Protocol Filter Profile</a> for more information on creating protocol filter profiles.</p> | Drop-down list of related protocol filter profiles / Manual   | N/A  |
| <b>Source Address</b>          | Shows the source address to check for in DNP3 packets, based on the selected <b>Protocol Filter Profile</b> . <p>If <b>Manual</b> is selected for the <b>Protocol Filter Profile</b>, specify the source address to check for in DNP3 packets.</p>  | 0 to 65535 / 0x0000 to 0xFFFF   | Depends on the selected <b>Protocol Filter Profile</b> |

| UI Setting                       | Description   | Valid Range                      | Default Value  |
|----------------------------------|---|----------------------------------|--|
| <b>Destination Address</b>       | Shows the destination address to check for in DNP3 packets, based on the selected <b>Protocol Filter Profile</b> .<br><br>If <b>Manual</b> is selected for the <b>Protocol Filter Profile</b> , specify the destination address to check for in DNP3 packets. | 0 to 65535 / 0x0000 to 0xFFFF    | Depends on the selected <b>Protocol Filter Profile</b> |
| <b>Application Function Code</b> | Shows which function code will be used for the object, based on the selected <b>Protocol Filter Profile</b> .<br><br>If <b>Manual</b> is selected for the <b>Protocol Filter Profile</b> , select which function code to use for this object.                 | Drop-down list of function codes | Depends on the selected <b>Protocol Filter Profile</b> |
| <b>Group</b>                     | Shows the group to use to classify types within a message, based on the selected <b>Protocol Filter Profile</b> .<br><br>If <b>Manual</b> is selected for the <b>Protocol Filter Profile</b> , specify the function code to use for this object.              | 0 to 255 or 0x00 to 0xFF         | Depends on the selected <b>Protocol Filter Profile</b> |
| <b>Variation</b>                 | Shows the variation to use for encoding formats, based on the selected <b>Protocol Filter Profile</b> .<br><br>If <b>Manual</b> is selected for the <b>Protocol Filter Profile</b> , specify the variation to use for this object.                            | 0 to 255 or 0x00 to 0xFF         | Depends on the selected <b>Protocol Filter Profile</b> |

## Create Object - MMS

If **MMS** is selected for the **Category**, these settings will appear.

| UI Setting                     | Description   | Valid Range   | Default Value |
|--------------------------------|---|---|---------------|
| <b>Name</b>                    | Specify a name for the object.  | 1 to 64 characters  | N/A           |
| <b>Category</b>                | Select a protocol for this object.<br><br><div style="background-color: #f0f0f0; padding: 5px;"> <p><b>Note</b><br/>Available settings will vary depending on your product model.</p> </div>  | Modbus/TCP / DNP3 / MMS / IEC-104 / EIP / Omron FINS / Step7Comm / TRDP / OPC UA / MELSEC / Step7Plus   | N/A           |
| <b>Protocol Filter Profile</b> | Select preset protocol filter profile or a user-configured protocol filter profile to use for this protocol filter object.<br><br><b>Manual:</b> Manually enter the settings for this object.<br><br>Refer to <a href="#">Firewall &gt; Advanced Protection &gt; Configuration - Protocol Filter Profile</a> for more information on creating protocol filter profiles. | Identify Service / Read Service / Write Service / Report Service / File Operation Service / Journal Service / Drop-down list of related protocol filter profiles / Manual | N/A           |
| <b>Device</b>                  | Specify a device name for the object.   | 1 to 255 characters   | N/A           |
| <b>Item ID</b>                 | Specify an item ID for the object.  | 1 to 255 characters   | N/A           |



| UI Setting               | Description  | Valid Range  | Default Value  |
|--------------------------|--|--|--|
| <b>Command Type</b>      | <p>Shows which MMS command type will be used for the object, based on the selected <b>Protocol Filter Profile</b>.</p> <p>If <b>Manual</b> is selected for the <b>Protocol Filter Profile</b>, select the command type to use for the object.</p> <p>Refer to <a href="#">MMS Command Types</a> for an overview of all command types.</p>  | Drop-down list of MMS command types                        | Depends on the selected <b>Protocol Filter Profile</b> |
| <b>Service</b>           | <p>Shows which service will be used for the object, based on the selected <b>Protocol Filter Profile</b>.</p> <p>If <b>Manual</b> is selected for the <b>Protocol Filter Profile</b>, select the service to use for the object.</p>  | Any / Confirmed Request / Confirmed Response / Unconfirmed | Depends on the selected <b>Protocol Filter Profile</b> |
| <b>Service Operation</b> | <p>Shows which service operations will be used for the object, based on the selected <b>Protocol Filter Profile</b>.</p> <p>If <b>Manual</b> is selected for the <b>Protocol Filter Profile</b>, select the service operations to use for the object. You can select multiple options.</p> <p>Refer to <a href="#">MMS Service Operation List</a> for an overview of all service operations.</p> | Drop-down list of service operations                       | Depends on the selected <b>Protocol Filter Profile</b> |
| <b>MMS Data Type</b>     | <p>Specify which MMS data types to use for the object. You can select multiple options.</p> <p>For each service operation, specify the values to use. You can specify multiple values by separating them with a comma.</p>   | Drop-down list of MMS data types<br>0 to 65535             | N/A  |

## Create Object - IEC-104

If **IEC-104** is selected for the **Category**, these settings will appear.

**Create Object**

Name \*  0 / 64

Category \*  
IEC-104 ▼

Protocol Filter Profile \*  
Manual ▼

Cause of Transmission \* ▼

Type Identification \* ▼

Originator Address  
0 - 255 or 0x00 - 0xFF

Common Address  
0 - 65535 or 0x0000 - 0xFFFF

| UI Setting                     | Description   | Valid Range   | Default Value |
|--------------------------------|---|---|---------------|
| <b>Name</b>                    | Specify a name for the object.  | 1 to 64 characters  | N/A           |
| <b>Category</b>                | Select a protocol for this object.<br><br><div style="background-color: #f0f0f0; padding: 5px; border: 1px solid #ccc;"> <p><b>Note</b></p> <p>Available settings will vary depending on your product model.</p> </div>   | Modbus/TCP / DNP3 / MMS / IEC-104 / EIP / Omron FINS / Step7Comm / TRDP / OPC UA / MELSEC / Step7Plus   | N/A           |
| <b>Protocol Filter Profile</b> | Select a user-configured protocol filter profile to use for this protocol filter object.<br><br><b>Manual:</b> Manually enter the settings for this object.<br><br>Refer to <a href="#">Firewall &gt; Advanced Protection &gt; Configuration - Protocol Filter Profile</a> for more information on creating protocol filter profiles. | Identify Service / Read Service / Write Service / Report Service / File Operation Service / Journal Service / Drop-down list of related protocol filter profiles / Manual | N/A           |

| UI Setting                   | Description   | Valid Range   | Default Value  |
|------------------------------|---|---|--|
| <b>Cause of Transmission</b> | Shows which IEC-104 cause of transmission code will be used for the object, based on the selected <b>Protocol Filter Profile</b> .<br><br>If <b>Manual</b> is selected for the <b>Protocol Filter Profile</b> , select the cause to use for the object.<br><br>Refer to the <a href="#">IEC-104 Cause of Transmission List</a> for an overview of the different codes and corresponding descriptions. | Drop-down list of IEC-104 cause of transmission codes | Depends on the selected <b>Protocol Filter Profile</b> |
| <b>Type Identification</b>   | Shows which IEC-104 type identification code will be used for the object, based on the selected <b>Protocol Filter Profile</b> .<br><br>If <b>Manual</b> is selected for the <b>Protocol Filter Profile</b> , select the type to use for the object.<br><br>Refer to the <a href="#">IEC-104 Type Identification List</a> for an overview of the different codes and corresponding descriptions.      | Drop-down list of IEC-104 type identification codes   | Depends on the selected <b>Protocol Filter Profile</b> |
| <b>Originator Address</b>    | Shows which originator address will be used for the object, based on the selected <b>Protocol Filter Profile</b> .<br><br>If <b>Manual</b> is selected for the <b>Protocol Filter Profile</b> , specify the address to use for the object.  | 0 to 255 / 0x00 to 0xFF                               | Depends on the selected <b>Protocol Filter Profile</b> |
| <b>Common Address</b>        | Shows which common address will be used for the object, based on the selected <b>Protocol Filter Profile</b> .<br><br>If <b>Manual</b> is selected for the <b>Protocol Filter Profile</b> , specify the address to use for the object.  | 0 to 65535 / 0x0000 to 0xFFFF                         | Depends on the selected <b>Protocol Filter Profile</b> |

## Create Object - EIP

If **EIP** is selected for the **Category**, these settings will appear.

### Create Object

Name \* 0 / 64

---

Category \*  
EIP ▼

---

Protocol Filter Profile \*  
Manual ▼

---

Command Code  
0 - 65535, allow comma(,)

---

Type ID  
0 - 65535, allow comma(,)

---

Device Type  
0 - 65535, allow comma(,)

---

Vendor ID  
0 - 65535, allow comma(,)

---

CANCEL
CREATE

| UI Setting                     | Description   | Valid Range   | Default Value |
|--------------------------------|---|---|---------------|
| <b>Name</b>                    | Specify a name for the object.  | 1 to 64 characters  | N/A           |
| <b>Category</b>                | Select a protocol for this object.<br><br><div style="background-color: #f0f0f0; padding: 5px; border: 1px solid #ccc;"> <p> <b>Note</b><br/>Available settings will vary depending on your product model.</p> </div>   | Modbus/TCP / DNP3 / MMS / IEC-104 / EIP / Omron FINS / Step7Comm / TRDP / OPC UA / MELSEC / Step7Plus | N/A           |
| <b>Protocol Filter Profile</b> | Select a user-configured protocol filter profile to use for this protocol filter object.<br><br><b>Manual:</b> Manually enter the settings for this object.<br><br>Refer to <a href="#">Firewall &gt; Advanced Protection &gt; Configuration - Protocol Filter Profile</a> for more information on creating protocol filter profiles. | Drop-down list of related protocol filter profiles / Manual   | N/A           |

| UI Setting          | Description  | Valid Range | Default Value  |
|---------------------|--|-------------|--|
| <b>Command Code</b> | Shows the EIP command codes that will be used for the object, based on the selected <b>Protocol Filter Profile</b> .<br><br>If <b>Manual</b> is selected for the <b>Protocol Filter Profile</b> , specify the command codes to use for this object. You can specify multiple values by separating them with a comma. | 0 - 65535   | Depends on the selected <b>Protocol Filter Profile</b> |
| <b>Type ID</b>      | Shows the type IDs that will be used for the object, based on the selected <b>Protocol Filter Profile</b> .<br><br>If <b>Manual</b> is selected for the <b>Protocol Filter Profile</b> , specify the type IDs to use for this object. You can specify multiple values by separating them with a comma.               | 0 - 65535   | Depends on the selected <b>Protocol Filter Profile</b> |
| <b>Device Type</b>  | Shows the device types that will be used for the object, based on the selected <b>Protocol Filter Profile</b> .<br><br>If <b>Manual</b> is selected for the <b>Protocol Filter Profile</b> , specify the device types to use for this object. You can specify multiple values by separating them with a comma.       | 0 - 65535   | Depends on the selected <b>Protocol Filter Profile</b> |
| <b>Vendor ID</b>    | Specify the vendor IDs to use for this object. You can specify multiple values by separating them with a comma.  | 0 to 65535  | N/A  |

## Create Object - Omron FINS

If **Omron FINS** is selected for the **Category**, these settings will appear.

### Create Object

Name \* 0 / 64

Category \*  
Omron FINS

Protocol Filter Profile \*  
Manual

TCP Command  
0 - 4294967295, allow comma(,)

Command Code  
0 - 65535, allow comma(,)

Error Code  
0 - 4294967295, allow comma(,)

Client Node Address  
0 - 4294967295, allow comma(,)

Server Node Address  
0 - 4294967295, allow comma(,)

CANCEL CREATE

| UI Setting                     | Description   | Valid Range   | Default Value  |
|--------------------------------|---|---|--|
| <b>Name</b>                    | Specify a name for the object.  | 1 to 64 characters  | N/A  |
| <b>Category</b>                | Select a protocol for this object. <div style="background-color: #f0f0f0; padding: 5px; margin-top: 10px;"> <p><b>Note</b><br/>Available settings will vary depending on your product model.</p> </div>   | Modbus/TCP / DNP3 / MMS / IEC-104 / EIP / Omron FINS / Step7Comm / TRDP / OPC UA / MELSEC / Step7Plus | N/A  |
| <b>Protocol Filter Profile</b> | Select a user-configured protocol filter profile to use for this protocol filter object. <p><b>Manual:</b> Manually enter the settings for this object.</p> <p>Refer to <a href="#">Firewall &gt; Advanced Protection &gt; Configuration - Protocol Filter Profile</a> for more information on creating protocol filter profiles.</p> | Drop-down list of related protocol filter profiles / Manual   | N/A  |
| <b>TCP Command</b>             | Shows the TCP command codes that will be used for the object, based on the selected <b>Protocol Filter Profile</b> . <p>If <b>Manual</b> is selected for the <b>Protocol Filter Profile</b>, specify the command codes to use for this object. You can specify multiple values by separating them with a comma.</p>                   | 0 to 4294967295   | Depends on the selected <b>Protocol Filter Profile</b> |

| UI Setting                         | Description  | Valid Range     | Default Value  |
|------------------------------------|--|-----------------|--|
| <b>Command Code</b>                | Shows the command codes that will be used for the object, based on the selected <b>Protocol Filter Profile</b> .<br><br>If <b>Manual</b> is selected for the <b>Protocol Filter Profile</b> , specify the command codes to use for this object. You can specify multiple values by separating them with a comma. | 0 to 65535      | Depends on the selected <b>Protocol Filter Profile</b> |
| <b>Error Code</b>                  | Shows the error codes that will be used for the object, based on the selected <b>Protocol Filter Profile</b> .<br><br>If <b>Manual</b> is selected for the <b>Protocol Filter Profile</b> , specify the error codes to use for this object. You can specify multiple values by separating them with a comma.     | 0 to 65535      | Depends on the selected <b>Protocol Filter Profile</b> |
| <b>Client Node Address</b>         | Specify the client node addresses to use for this object. You can specify multiple values by separating them with a comma.   | 0 to 4294967295 | N/A  |
| <b>Server Node Address</b>         | Specify the server node addresses to use for this object. You can specify multiple values by separating them with a comma.   | 0 to 4294967295 | N/A  |
| <b>File Position</b>               | Specify the file positions to use for this object. You can specify multiple values by separating them with a comma.  | 0 to 65535      | N/A  |
| <b>File Position Begin Address</b> | Specify the file position begin addresses to use for this object. You can specify multiple values by separating them with a comma.   | 0 to 65535      | N/A  |
| <b>Begin Address</b>               | Specify the begin addresses to use for this object. You can specify multiple values by separating them with a comma.   | 0 to 65535      | N/A  |
| <b>Record Begin Address</b>        | Specify the record begin addresses to use for this object. You can specify multiple values by separating them with a comma.  | 0 to 65535      | N/A  |

## Create Object - Step7Comm

If **Step7Comm** is selected for the **Category**, these settings will appear.

**Create Object**

Name \*  0 / 64

Category \*  
Step7Comm ▼

Protocol Filter Profile \*  
Manual ▼

ROSCTR  
USER DATA ▼

Function Group  
0 - 15 or 0x0 - 0xF

Sub-function  
0 - 255 or 0x00 - 0xFF

CANCEL CREATE

| UI Setting                         | Description   | Valid Range   | Default Value  |
|------------------------------------|---|---|--|
| <b>Name</b>                        | Specify a name for the object.  | 1 to 64 characters  | N/A  |
| <b>Category</b>                    | Select a protocol for this object. <div style="background-color: #f0f0f0; padding: 5px; margin-top: 10px;"> <p> <b>Note</b><br/>Available settings will vary depending on your product model.</p> </div>  | Modbus/TCP / DNP3 / MMS / IEC-104 / EIP / Omron FINS / Step7Comm / TRDP / OPC UA / MELSEC / Step7Plus | N/A  |
| <b>Protocol Filter Profile</b>     | Select a user-configured protocol filter profile to use for this protocol filter object. <p><b>Manual:</b> Manually enter the settings for this object.</p> <p>Refer to <a href="#">Firewall &gt; Advanced Protection &gt; Configuration - Protocol Filter Profile</a> for more information on creating protocol filter profiles.</p> | Drop-down list of related protocol filter profiles / Manual   | N/A  |
| <b>ROSCTR</b>                      | Shows the ROSCTR control that will be used for the object, based on the selected <b>Protocol Filter Profile</b> . <p>If <b>Manual</b> is selected for the <b>Protocol Filter Profile</b>, specify the ROSCTR control to use for this object.</p>  | ANY / JOB / USER DATA   | Depends on the selected <b>Protocol Filter Profile</b> |
| <b>Function (if ROSCTR is JOB)</b> | Shows the function code that will be used for the object, based on the selected <b>Protocol Filter Profile</b> . <p>If <b>Manual</b> is selected for the <b>Protocol Filter Profile</b>, specify the function code to use for this object.</p>  | 0 to 255 / 0x00 to 0xFF   | Depends on the selected <b>Protocol Filter Profile</b> |



| UI Setting  | Description  | Valid Range             | Default Value  |
|---|--|-------------------------|--|
| <b>Function Group</b><br>(if ROSCTR is USER DATA) | Shows the function group that will be used for the object, based on the selected <b>Protocol Filter Profile</b> .<br>If <b>Manual</b> is selected for the <b>Protocol Filter Profile</b> , specify the function group to use for this object.        | 0 to 15 / 0x0 to 0xF    | Depends on the selected <b>Protocol Filter Profile</b> |
| <b>Sub-function</b><br>(if ROSCTR is USER DATA)   | Shows the sub-function group that will be used for the object, based on the selected <b>Protocol Filter Profile</b> .<br>If <b>Manual</b> is selected for the <b>Protocol Filter Profile</b> , specify the sub-function code to use for this object. | 0 to 255 / 0x00 to 0xFF | Depends on the selected <b>Protocol Filter Profile</b> |

## Create Object - TRDP

If **TRDP** is selected for the **Category**, these settings will appear.

### Create Object

Name \*  0 / 64

Category \*  
TRDP ▼

Protocol Filter Profile  
Manual ▼

Message Type \* ▼

Communication Iden... ▼

CANCEL
CREATE

| UI Setting  | Description                    | Valid Range        | Default Value |
|-------------|--------------------------------|--------------------|---------------|
| <b>Name</b> | Specify a name for the object. | 1 to 64 characters | N/A           |

| UI Setting                      | Description   | Valid Range   | Default Value  |
|---------------------------------|---|---|--|
| <b>Category</b>                 | <p>Select a protocol for this object.</p> <div style="background-color: #f0f0f0; padding: 5px; margin-top: 10px;"> <p><b>Note</b></p> <p>Available settings will vary depending on your product model.</p> </div>   | Modbus/TCP / DNP3 / MMS / IEC-104 / EIP / Omron FINS / Step7Comm / TRDP / OPC UA / MELSEC / Step7Plus | N/A  |
| <b>Protocol Filter Profile</b>  | <p>Select a preset protocol filter profile or a user-configured protocol filter profile to use for this protocol filter object.</p> <p><b>Manual:</b> Manually enter the settings for this object.</p> <p>Refer to <a href="#">TRDP Protocol Filter Profiles</a> for more information on TRDP presets.</p> <p>Refer to <a href="#">Firewall &gt; Advanced Protection &gt; Configuration - Protocol Filter Profile</a> for more information on creating protocol filter profiles.</p>  | Drop-down list of related protocol filter profiles / Manual   | N/A  |
| <b>Message Type</b>             | <p>Shows which message types will be used for the object, based on the selected <b>Protocol Filter Profile</b>.</p> <p>If <b>Manual</b> is selected for the <b>Protocol Filter Profile</b>, select which message types to use for this object. You can select multiple options.</p> <p>Refer to <a href="#">TRDP Message Types</a> for more information.</p>  | Drop-down list of message types   | Depends on the selected <b>Protocol Filter Profile</b> |
| <b>Communication Identifier</b> | <p>Shows which communication identifiers will be used for the object, based on the selected <b>Protocol Filter Profile</b>.</p> <p>If <b>Manual</b> is selected for the <b>Protocol Filter Profile</b>, select which communication identifiers to use for this object. You can select multiple options. The last option in the list lets you add your own communication identifiers. You can specify multiple values by separating them with a comma.</p> <p>Refer to <a href="#">IEC 61375-2-3 Communication Identifiers</a> for more information.</p> | <p>Drop-down list of communication identifiers</p> <p>1 to 4294967295</p>                             | Depends on the selected <b>Protocol Filter Profile</b> |

## Create Object - OPC UA

If **OPC UA** is selected for the **Category**, these settings will appear.

### Create Object

Name \* 0 / 32

---

Category \*  
OPC UA ▼

Protocol Filter Profile \*  
Manual ▼

Service ID  
0 - 65535 or 0x0000 - 0xFFFF

Message Type 0 / 3

---

CANCEL
CREATE

| UI Setting                     | Description   | Valid Range   | Default Value |
|--------------------------------|---|---|---------------|
| <b>Name</b>                    | Specify a name for the object.  | 1 to 64 characters  | N/A           |
| <b>Category</b>                | Select a protocol for this object.<br><br><div style="background-color: #f0f0f0; padding: 5px; border: 1px solid #ccc;"> <p> <b>Note</b><br/>             Available settings will vary depending on your product model.</p> </div>  | Modbus/TCP / DNP3 / MMS / IEC-104 / EIP / Omron FINS / Step7Comm / TRDP / OPC UA / MELSEC / Step7Plus | N/A           |
| <b>Protocol Filter Profile</b> | Select a preset protocol filter profile or a user-configured protocol filter profile to use for this protocol filter object.<br><br><b>Manual:</b> Manually enter the settings for this object.<br><br>Refer to <a href="#">Firewall &gt; Advanced Protection &gt; Configuration - Protocol Filter Profile</a> for more information on creating protocol filter profiles. | Drop-down list of related protocol filter profiles / Manual   | N/A           |
| <b>Service ID</b>              | Specify the service ID for this object in decimal or hexadecimal format.  | 0 to 65535, 0x0000 to 0xFFFF  | N/A           |

| UI Setting          | Description  | Valid Range       | Default Value |
|---------------------|--|-------------------|---------------|
| <b>Message Type</b> | Specify the message type for the message.<br><br><div style="background-color: #f0f0f0; padding: 5px;"> <p><b>Note</b></p> <p>Some defined message types are:</p> <ul style="list-style-type: none"> <li>• HEL: Hello message</li> <li>• ACK: Acknowledge message</li> <li>• ERR: Error message</li> <li>• RHE: ReverseHello message</li> </ul> </div> | 0 to 3 characters | N/A           |

### Create Object - MELSEC

If **MELSEC** is selected for the **Category**, these settings will appear.

#### Create Object

Name \*  0 / 32

Category \*  
MELSEC ▼

Protocol Filter Profile \*  
Manual ▼

Command   
0 - 65535 or 0x0000 - 0xFFFF

SUB-Command   
0 - 65535 or 0x0000 - 0xFFFF

| UI Setting  | Description  | Valid Range        | Default Value |
|-------------|--|--------------------|---------------|
| <b>Name</b> | Specify a name for the object.Modbus/TCP / DNP3 / MMS / IEC-104 / EIP / Omron FINS / Step7Comm / OPC UA / MELSEC / Step7Plus | 1 to 64 characters | N/A           |

| UI Setting                     | Description   | Valid Range   | Default Value |
|--------------------------------|---|---|---------------|
| <b>Category</b>                | Select a protocol for this object.<br><div style="border: 1px solid #ccc; background-color: #f9f9f9; padding: 5px; margin-top: 10px;"> <p><b>Note</b></p> <p>Available settings will vary depending on your product model.</p> </div>   | Modbus/TCP / DNP3 / MMS / IEC-104 / EIP / Omron FINS / Step7Comm / TRDP / OPC UA / MELSEC / Step7Plus | N/A           |
| <b>Protocol Filter Profile</b> | Select a preset protocol filter profile or a user-configured protocol filter profile to use for this protocol filter object.<br><b>Manual:</b> Manually enter the settings for this object.<br>Refer to <a href="#">Firewall &gt; Advanced Protection &gt; Configuration - Protocol Filter Profile</a> for more information on creating protocol filter profiles. | Drop-down list of related protocol filter profiles / Manual   | N/A           |
| <b>Command</b>                 | Specify a command for this profile.   | 0 - 65535 or 0x0000 - 0xFFFF  | N/A           |
| <b>SUB-Command</b>             | Specify a sub-command for this profile.   | 0 - 65535 or 0x0000 - 0xFFFF  | N/A           |

## Create Object - Step7Plus

If **Step7Plus** is selected for the **Category**, these settings will appear.

### Create Object

Name \* 0 / 32

Category \*  
Step7Plus

Protocol Filter Profile \*  
Manual

Function  
0 - 65535 or 0x0000 - 0xFFFF

CANCEL CREATE

| UI Setting                     | Description   | Valid Range   | Default Value |
|--------------------------------|---|---|---------------|
| <b>Name</b>                    | Specify a name for the object. Modbus/TCP / DNP3 / MMS / IEC-104 / EIP / Omron FINS / Step7Comm / OPC UA / MELSEC / Step7Plus   | 1 to 64 characters  | N/A           |
| <b>Category</b>                | Select a protocol for this object. <div style="background-color: #f0f0f0; padding: 5px; margin-top: 10px;"> <p> <b>Note</b><br/>Available settings will vary depending on your product model.</p> </div>   | Modbus/TCP / DNP3 / MMS / IEC-104 / EIP / Omron FINS / Step7Comm / TRDP / OPC UA / MELSEC / Step7Plus | N/A           |
| <b>Protocol Filter Profile</b> | Select a preset protocol filter profile or a user-configured protocol filter profile to use for this protocol filter object. <p><b>Manual:</b> Manually enter the settings for this object.</p> <p>Refer to <a href="#">Firewall &gt; Advanced Protection &gt; Configuration - Protocol Filter Profile</a> for more information on creating protocol filter profiles.</p> | Drop-down list of related protocol filter profiles / Manual   | N/A           |
| <b>Function</b>                | Specify a Step7Plus function code for this profile.   | 0 - 65535 or 0x0000 - 0xFFFF  | N/A           |

## Protocol Filter Profile

### Menu Path: Firewall > Advanced Protection > Configuration - Protocol Filter Profile

This page lets you create and manage protocol filter profiles to simplify maintaining protocol-related settings. Protocol filter profiles can be used when creating protocol filter objects, and a single profile can be used in multiple protocol filter objects.

#### Note

Available protocols may vary across different product models and versions.

#### Limitations

You can create up to 50 protocol filter profiles.

| <input type="checkbox"/> Protocol Filter Profile |               | Category   |
|--|---------------|------------|
| <input type="checkbox"/>                         | readcoilstest | Modbus/TCP |
| <input type="checkbox"/>                         | ddd           | Modbus/TCP |
| <input type="checkbox"/>                         | EIPTest       | EIP        |
| <input type="checkbox"/>                         | DNP3Test      | DNP3       |
| <input type="checkbox"/>                         | TestOmron     | Omron FINS |
| <input type="checkbox"/>                         | TestMMS       | MMS        |

Max. 50 1 - 6 of 6 < >

| UI Setting                     | Description                                 |
|--------------------------------|---|
| <b>Protocol Filter Profile</b> | Shows the name of the profile.              |
| <b>Category</b>                | Shows the protocol category of the profile. |

### Protocol Filter Profile - Create Profile

#### Menu Path: Firewall > Advanced Protection > Configuration - Protocol Filter Profile

Clicking the **Add (+)** icon on the **Firewall > Advanced Protection > Configuration - Protocol Filter Profile** page will open this dialog box. This dialog lets you create a protocol filter profile. Click **CREATE** to save your changes and add the new profile.

#### Create Profile - Modbus/TCP

If **Modbus/TCP** is selected for the **Category**, these settings will appear.

### Create Profile

Name \*  0 / 64

Category \*  
 ▼

Function Code \*  ▼

CANCEL CREATE

| UI Setting           | Description  | Valid Range   | Default Value |
|----------------------|--|---|---------------|
| <b>Name</b>          | Specify a name for the profile.  | 1 to 64 characters  | N/A           |
| <b>Category</b>      | Select a protocol for this profile. <div style="background-color: #f0f0f0; padding: 5px; margin-top: 10px;"> <p><b>Note</b><br/>Available settings will vary depending on your product model.</p> </div> | Modbus/TCP / DNP3 / MMS / IEC-104 / EIP / Omron FINS / Step7Comm / TRDP / OPC UA / MELSEC / Step7Plus | N/A           |
| <b>Function Code</b> | Select which function codes to use for this profile. You can select multiple options.  | Drop-down list of function codes  | N/A           |

### Create Profile - DNP3

If **DNP3** is selected for the **Category**, these settings will appear.



### Create Profile

Name \*  
 0 / 64

Category \*  
 DNP3 ▼

Source Address  
  
 0 - 65535 or 0x0000 - 0xFFFF

Destination Address  
  
 0 - 65535 or 0x0000 - 0xFFFF

Application Function Code \* ▼

Group  
  
 0 - 255 or 0x00 - 0xFF

Variation  
  
 0 - 255 or 0x00 - 0xFF

CANCEL CREATE

| UI Setting                 | Description   | Valid Range   | Default Value |
|----------------------------|---|---|---------------|
| <b>Name</b>                | Specify a name for the profile.   | 1 to 64 characters  | N/A           |
| <b>Category</b>            | Select a protocol for this profile.<br><br><div style="border: 1px solid #ccc; background-color: #f9f9f9; padding: 5px;"> <p><b>Note</b><br/>Available settings will vary depending on your product model.</p> </div> | Modbus/TCP / DNP3 / MMS / IEC-104 / EIP / Omron FINS / Step7Comm / TRDP / OPC UA / MELSEC / Step7Plus | N/A           |
| <b>Source Address</b>      | Specify the source address to check for in DNP3 packets.  | 0 to 65535 / 0x0000 to 0xFFFF   | N/A           |
| <b>Destination Address</b> | Specify the destination address to check for in DNP3 packets.   | 0 to 65535 / 0x0000 to 0xFFFF   | N/A           |

| UI Setting                       | Description   | Valid Range                      | Default Value |
|----------------------------------|---|----------------------------------|---------------|
| <b>Application Function Code</b> | Select which function code to use for this profile. | Drop-down list of function codes | N/A           |
| <b>Group</b>                     | Specify the function code to use for this profile.  | 0 to 255 or 0x00 to 0xFF         | N/A           |
| <b>Variation</b>                 | Specify the variation to use for this profile.      | 0 to 255 or 0x00 to 0xFF         | N/A           |

### Create Profile - MMS

If **MMS** is selected for the **Category**, these settings will appear.

#### Create Profile

Name \*  0 / 64

Category \*  
MMS ▼

Common Type \* ▼

Service \* ▼

Service Operation \* ▼

CANCEL CREATE

| UI Setting  | Description                     | Valid Range        | Default Value |
|-------------|---------------------------------|--------------------|---------------|
| <b>Name</b> | Specify a name for the profile. | 1 to 64 characters | N/A           |

| UI Setting               | Description   | Valid Range   | Default Value |
|--------------------------|---|---|---------------|
| <b>Category</b>          | Select a protocol for this profile.<br><br><div style="border: 1px solid #ccc; background-color: #f9f9f9; padding: 5px;"> <p> <b>Note</b><br/>Available settings will vary depending on your product model.</p> </div> | Modbus/TCP / DNP3 / MMS / IEC-104 / EIP / Omron FINS / Step7Comm / TRDP / OPC UA / MELSEC / Step7Plus | N/A           |
| <b>Command Type</b>      | Select the command type to use for the profile.<br><br>Refer to <a href="#">MMS Command Types</a> for an overview of all command types.   | Drop-down list of MMS command types   | N/A           |
| <b>Service</b>           | Select the service to use for the profile.  | Any / Confirmed Request / Confirmed Response / Unconfirmed  | N/A           |
| <b>Service Operation</b> | Select the service operations to use for the profile. You can select multiple options.<br><br>Refer to <a href="#">MMS Service Operation List</a> for an overview of all service operations.  | Drop-down list of service operations  | N/A           |

### Create Profile - IEC-104

If **IEC-104** is selected for the **Category**, these settings will appear.

### Create Profile

Name \*  
  
 0 / 64

Category \*  
 IEC-104 ▼

Cause of Transmission \* ▼

Type Identification \* ▼

Originator Address  
  
 0 - 255 or 0x00 - 0xFF

Common Address  
  
 0 - 65535 or 0x0000 - 0xFFFF

CANCEL CREATE

| UI Setting                   | Description   | Valid Range   | Default Value |
|------------------------------|---|---|---------------|
| <b>Name</b>                  | Specify a name for the profile.   | 1 to 64 characters  | N/A           |
| <b>Category</b>              | Select a protocol for this profile.<br><br><div style="background-color: #f0f0f0; padding: 5px;"> <p><b>Note</b></p> <p>Available settings will vary depending on your product model.</p> </div>                    | Modbus/TCP / DNP3 / MMS / IEC-104 / EIP / Omron FINS / Step7Comm / TRDP / OPC UA / MELSEC / Step7Plus | N/A           |
| <b>Cause of Transmission</b> | Select the IEC-104 cause of transmission code to use for the profile.<br><br>Refer to the <a href="#">IEC-104 Cause of Transmission List</a> for an overview of the different codes and corresponding descriptions. | Drop-down list of IEC-104 cause of transmission codes   | N/A           |

| UI Setting                 | Description   | Valid Range   | Default Value |
|----------------------------|---|---|---------------|
| <b>Type Identification</b> | Select the IEC-104 type identification code to use for the profile.<br><br>Refer to the <a href="#">IEC-104 Type Identification List</a> for an overview of the different codes and corresponding descriptions. | Drop-down list of IEC-104 type identification codes | N/A           |
| <b>Originator Address</b>  | Specify the originator address to use for the profile.  | 0 to 255 / 0x00 to 0xFF                             | N/A           |
| <b>Common Address</b>      | Specify the common address to use for the profile.  | 0 to 65535 / 0x0000 to 0xFFFF                       | N/A           |

## Create Profile - EIP

If **EIP** is selected for the **Category**, these settings will appear.

### Create Profile

Name \*  
  
0 / 64

Category \*  
EIP ▼

---

Command Code  
  
0 - 65535, allow comma(,)

Type ID  
  
0 - 65535, allow comma(,)

Device Type  
  
0 - 65535, allow comma(,)

CANCEL
CREATE

| UI Setting  | Description                     | Valid Range        | Default Value |
|-------------|---------------------------------|--------------------|---------------|
| <b>Name</b> | Specify a name for the profile. | 1 to 64 characters | N/A           |

| UI Setting          | Description   | Valid Range   | Default Value |
|---------------------|---|---|---------------|
| <b>Category</b>     | Select a protocol for this profile.<br><br><div style="border: 1px solid #ccc; background-color: #f9f9f9; padding: 5px; margin-top: 10px;"> <p><b>Note</b><br/>Available settings will vary depending on your product model.</p> </div> | Modbus/TCP / DNP3 / MMS / IEC-104 / EIP / Omron FINS / Step7Comm / TRDP / OPC UA / MELSEC / Step7Plus | N/A           |
| <b>Command Code</b> | Specify the command codes to use for this profile. You can specify multiple values by separating them with a comma.   | 0 - 65535   | N/A           |
| <b>Type ID</b>      | Specify the type IDs to use for this profile. You can specify multiple values by separating them with a comma.  | 0 - 65535   | N/A           |
| <b>Device Type</b>  | Specify the device types to use for this profile. You can specify multiple values by separating them with a comma.  | 0 - 65535   | N/A           |

### Create Profile - Omron FINS

If **Omron FINS** is selected for the **Category**, these settings will appear.

**Create Profile**

Name \*  0 / 64

Category  
Omron FINS

TCP Command  
0 - 4294967295, allow comma(,)

Command Code  
0 - 65535, allow comma(,)

Error Code  
0 - 4294967295, allow comma(,)

CANCEL CREATE

| UI Setting  | Description                     | Valid Range        | Default Value |
|-------------|---------------------------------|--------------------|---------------|
| <b>Name</b> | Specify a name for the profile. | 1 to 64 characters | N/A           |

| UI Setting          | Description   | Valid Range   | Default Value |
|---------------------|---|---|---------------|
| <b>Category</b>     | Select a protocol for this profile.<br><br><div style="background-color: #f0f0f0; padding: 5px; border: 1px solid #ccc;"> <p><b>Note</b><br/>Available settings will vary depending on your product model.</p> </div> | Modbus/TCP / DNP3 / MMS / IEC-104 / EIP / Omron FINS / Step7Comm / TRDP / OPC UA / MELSEC / Step7Plus | N/A           |
| <b>TCP Command</b>  | Specify the TCP command codes to use for this profile. You can specify multiple values by separating them with a comma.   | 0 to 4294967295   | N/A           |
| <b>Command Code</b> | Specify the command codes to use for this profile. You can specify multiple values by separating them with a comma.   | 0 to 65535  | N/A           |
| <b>Error Code</b>   | Specify the error codes to use for this profile. You can specify multiple values by separating them with a comma.   | 0 to 65535  | N/A           |

### Create Profile - Step7Comm

If **Step7Comm** is selected for the **Category**, these settings will appear.

#### Create Profile

Name \*  
  
0 / 64

Category \*

ROSCTR

Function Group  
  
0 - 15 or 0x0 - 0xF

Sub-function  
  
0 - 255 or 0x00 - 0xFF

CANCEL
CREATE

| UI Setting  | Description   | Valid Range   | Default Value |
|---|---|---|---------------|
| <b>Name</b>                                       | Specify a name for the profile.   | 1 to 64 characters  | N/A           |
| <b>Category</b>                                   | Select a protocol for this profile.<br><div style="background-color: #f0f0f0; padding: 5px; margin-top: 10px;"> <p><b>Note</b><br/>Available settings will vary depending on your product model.</p> </div> | Modbus/TCP / DNP3 / MMS / IEC-104 / EIP / Omron FINS / Step7Comm / TRDP / OPC UA / MELSEC / Step7Plus | N/A           |
| <b>ROSCTR</b>                                     | Specify the ROSCTR control to use for this profile.   | ANY / JOB / USER DATA   | N/A           |
| <b>Function</b><br>(if ROSCTR is JOB)             | Specify the function code to use for this profile.  | 0 to 255 / 0x00 to 0xFF   | N/A           |
| <b>Function Group</b><br>(if ROSCTR is USER DATA) | Specify the function group to use for this profile.   | 0 to 15 / 0x0 to 0xF  | N/A           |
| <b>Sub-function</b><br>(if ROSCTR is USER DATA)   | Specify the sub-function code to use for this profile.  | 0 to 255 / 0x00 to 0xFF   | N/A           |

### Create Profile - TRDP

If **TRDP** is selected for the **Category**, these settings will appear.



### Create Profile

Name \*  0 / 64

Category \*  
TRDP ▼

Message Type \* ▼

Communication Iden... ▼

CANCEL
CREATE

| UI Setting                      | Description   | Valid Range   | Default Value |
|---------------------------------|---|---|---------------|
| <b>Name</b>                     | Specify a name for the profile.   | 1 to 64 characters  | N/A           |
| <b>Category</b>                 | Select a protocol for this profile. <div style="background-color: #f0f0f0; padding: 5px; margin-top: 10px;"> <p><b>Note</b></p> <p>Available settings will vary depending on your product model.</p> </div>   | Modbus/TCP / DNP3 / MMS / IEC-104 / EIP / Omron FINS / Step7Comm / TRDP / OPC UA / MELSEC / Step7Plus | N/A           |
| <b>Message Type</b>             | Select which message types to use for this profile. You can select multiple options.<br>Refer to <a href="#">TRDP Message Types</a> for more information.   | Drop-down list of message types   | N/A           |
| <b>Communication Identifier</b> | Select which communication identifiers to use for this profile. You can select multiple options. The last option in the list lets you add your own communication identifier. You can specify multiple values by separating them with a comma.<br>Refer to <a href="#">IEC 61375-2-3 Communication Identifiers</a> for more information. | Drop-down list of communication identifiers<br>1 to 4294967295  | N/A           |

## Create Profile - OPC UA

If **OPC UA** is selected for the **Category**, these settings will appear.

### Create Profile

Name \* 0 / 32

---

Category \*  
OPC UA ▼

---

Service ID

---

0 - 65535 or 0x0000 - 0xFFFF

Message Type 0 / 3

---

CANCEL
CREATE

| UI Setting          | Description   | Valid Range   | Default Value |
|---------------------|---|---|---------------|
| <b>Name</b>         | Specify a name for the profile.   | 1 to 32 characters  | N/A           |
| <b>Category</b>     | Select a protocol for this profile. <div style="background-color: #f0f0f0; padding: 5px; margin-top: 5px;"> <p><b>Note</b><br/>Available settings will vary depending on your product model.</p> </div> | Modbus/TCP / DNP3 / MMS / IEC-104 / EIP / Omron FINS / Step7Comm / TRDP / OPC UA / MELSEC / Step7Plus | N/A           |
| <b>Service ID</b>   | Specify an OPC UA Service ID for this profile.  | 0-4294967295 or 0x00000000 - 0xFFFFFFFF   | N/A           |
| <b>Message Type</b> | Specify the message type.   | 0 to 3 characters   | N/A           |

## Create Profile - MELSEC

If **MELSEC** is selected for the **Category**, these settings will appear.

## Edit Profile

Name \*  
 MELSEC\_Test  
 11 / 32

Category \*  
 MELSEC ▼

Command  
 0 - 65535 or 0x0000 - 0xFFFF

SUB-Command  
 0 - 65535 or 0x0000 - 0xFFFF

CANCEL APPLY

| UI Setting         | Description   | Valid Range   | Default Value |
|--------------------|---|---|---------------|
| <b>Name</b>        | Specify a name for the profile.   | 1 to 32 characters  | N/A           |
| <b>Category</b>    | Select a protocol for this profile.<br><br><div style="background-color: #f0f0f0; padding: 5px;"> <p><b>Note</b><br/>Available settings will vary depending on your product model.</p> </div> | Modbus/TCP / DNP3 / MMS / IEC-104 / EIP / Omron FINS / Step7Comm / TRDP / OPC UA / MELSEC / Step7Plus | N/A           |
| <b>Command</b>     | Specify a command for this profile.   | 0 - 65535 or 0x0000 - 0xFFFF  | N/A           |
| <b>SUB-Command</b> | Specify a sub-command for this profile.   | 0 - 65535 or 0x0000 - 0xFFFF  | N/A           |

## Create Profile - Step7Plus

If **Step7Plus** is selected for the **Category**, these settings will appear.

### Edit Profile

Name \*  
  
9 / 32

Category \*  
  
▼

Function

CANCEL
APPLY

| UI Setting      | Description  | Valid Range   | Default Value |
|-----------------|--|---|---------------|
| <b>Name</b>     | Specify a name for the profile.  | 1 to 32 characters  | N/A           |
| <b>Category</b> | Select a protocol for this profile. <div style="background-color: #f0f0f0; padding: 5px; margin-top: 10px;"> <p><b>Note</b><br/>Available settings will vary depending on your product model.</p> </div> | Modbus/TCP / DNP3 / MMS / IEC-104 / EIP / Omron FINS / Step7Comm / TRDP / OPC UA / MELSEC / Step7Plus | N/A           |
| <b>Function</b> | Specify a Step7Plus function code for this profile.  | 0 - 65535 or 0x0000 - 0xFFFF  | N/A           |

# Protocol Filter Policy

## Menu Path: Firewall > Advanced Protection > Protocol Filter Policy

This page lets you manage your application firewall's protocol filtering policies, which allow you to inspect industrial protocol packets. This allows you to control protocol traffic based on the configured protocol filter policies and Anomaly Detection and Protection (ADP) settings.

Refer to [ADP](#) for more information.

### Note

Before creating protocol filter policies, you will need to set up protocol filter objects to define what application protocols your policies will apply to.

Refer to Firewall > Configuration - Protocol Filter Object for more information.

### Limitations

You can create up to 200 protocol filter policies.

| Protocol Filter Policy |                 |          |                        |                |              |           |                |          |              |                      |        |  |
|------------------------|-----------------|----------|------------------------|----------------|--------------|-----------|----------------|----------|--------------|----------------------|--------|--|
| Index                  | Policy Name     | Status   | Protocol Filter Object | From Interface | To Interface | Source IP | Destination IP | Protocol | Command Type | Application Protocol | Action |  |
| 1                      | Modbus_reject   | Enabled  | Modbus_Read_Only       | Any            | Any          | Any       | Any            | Any      | Master Query | Modbus/TCP           | Accept |  |
| 2                      | Modbus_write    | Enabled  | Modbus_write           | Any            | Any          | Any       | Any            | Any      | Master Query | Modbus/TCP           | Reset  |  |
| 3                      | Modbus_test     | Disabled | Modbus_readwrite_test  | Any            | Any          | Any       | Any            | Any      | Master Query | Modbus/TCP           | Accept |  |
| 4                      | EIPTestPolicy   | Enabled  | EIP_Test               | Any            | Any          | Any       | Any            | Any      | Master Query | EIP                  | Reset  |  |
| 5                      | ddd             | Disabled | Modbus_Manual          | Any            | Any          | Any       | Any            | Any      | Master Query | Modbus/TCP           | Accept |  |
| 6                      | MOXA_testL_test | Disabled | MOXA_test              | Any            | Any          | Any       | Any            | Any      | Master Query | Modbus/TCP           | Accept |  |

| UI Setting                    | Description   |
|-------------------------------|---|
| <b>Index</b>                  | Shows the index of the policy.                        |
| <b>Policy Name</b>            | Shows the name of the policy.                         |
| <b>Status</b>                 | Shows whether the policy is enabled or disabled.      |
| <b>Protocol Filter Object</b> | Shows the protocol filter object used for the policy. |
| <b>From Interface</b>         | Shows the From Interface for the policy.              |

| UI Setting                  | Description  |
|-----------------------------|--|
| <b>To Interface</b>         | Shows the To Interface for the policy.                                     |
| <b>Source IP</b>            | Shows the source IP addresses for the policy.                              |
| <b>Destination IP</b>       | Shows the destination IP addresses for the policy.                         |
| <b>Protocol</b>             | Shows the protocols for the policy.  |
| <b>Command Type</b>         | Shows the packet transmission direction for this policy.                   |
| <b>Application Protocol</b> | Shows the industrial protocol for this policy.                             |
| <b>Action</b>               | Shows the action the firewall will take for packets that match the policy. |

## Add Policy

### Menu Path: Firewall > Advanced Protection > Protocol Filter Policy

Clicking the **Add (+)** icon on the **Firewall > Advanced Protection > Protocol Filter Policy** page will open this dialog box. This dialog lets you create a new protocol filter policy. Click **APPLY** to save your changes and add the new policy.

**Add Policy**

Index \*  
1  
1 - 200

Policy Name \*  
0 / 64

Status \*  
Disabled

From Interface \*      To Interface \*  
Any                      Any

Source IP \*  
Any

Destination IP \*  
Any



Protocol \*  
Any

Command Type \*  
Master Query

Application Protocol \*  
-

Action \*  
Accept

CANCEL    APPLY

| UI Setting            | Description   | Valid Range                   | Default Value |
|-----------------------|---|-------------------------------|---------------|
| <b>Index</b>          | Specify the index of the policy.  | 1-200                         | 1             |
| <b>Policy Name</b>    | Specify a name for the policy.  | 1 to 64 characters            | N/A           |
| <b>Status</b>         | Enable or disable the policy.   | Enabled / Disabled            | Disabled      |
| <b>From Interface</b> | Select the From Interface for the policy. <div style="background-color: #f0f0f0; padding: 10px; margin-top: 10px;"> <p> <b>Note</b></p> <p>Available interfaces will vary depending on your product model and configuration. Refer to <a href="#">Network Configuration &gt; Network Interfaces</a> for more information about managing your device's interfaces.</p> </div>   | Any / Drop-down of interfaces | Any           |
| <b>To Interface</b>   | Select the To Interface for the policy. <div style="background-color: #f0f0f0; padding: 10px; margin-top: 10px;"> <p> <b>Note</b></p> <p>Available interfaces will vary depending on your product model and configuration. Refer to <a href="#">Network Configuration &gt; Network Interfaces</a> for more information about managing your device's interfaces.</p> </div>  | Any / Drop-down of interfaces | Any           |
| <b>Source IP</b>      | Select how the policy will check the packet's source IP address. <p><b>Any:</b> The policy will check all source IP addresses in the packet.</p> <p><b>Single:</b> The policy will only check for the specified source IP address in the packet.</p> <p><b>Range:</b> The policy will check all source IP addresses in the packet within the specified IP range.</p> <p><b>Subnet:</b> The policy will check for source IP addresses in the packet that are within the specified subnet mask.</p>                             | Any / Single / Range / Subnet | Any           |
| <b>Destination IP</b> | To decide how the policy will check the packet's destination IP address. <p><b>Any:</b> The policy will check all destination IP addresses in the packet.</p> <p><b>Single:</b> The policy will only check for the specified destination IP address in the packet.</p> <p><b>Range:</b> The policy will check all destination IP addresses in the packet within the specified IP range.</p> <p><b>Subnet:</b> The policy will check for destination IP addresses in the packet that are within the specified subnet mask.</p> | Any / Single / Range / Subne  | Any           |

| UI Setting                  | Description   | Valid Range                   | Default Value |
|-----------------------------|---|-------------------------------|---------------|
| <b>Protocol</b>             | Select the protocol for this policy.  | Any / TCP / UDP               | Any           |
| <b>Command Type</b>         | Select the packet transmission direction for this policy.   | Master Query / Slave Response | Master Query  |
| <b>Application Protocol</b> | Select the protocol filter object to use to define the application protocol for this policy.<br><br>Refer to <a href="#">Firewall &gt; Advanced Protection &gt; Configuration - Protocol Filter Object</a> for more information.  | Custom object                 | N/A           |
| <b>Action</b>               | Select the action to take for packets that match the policy.<br><br><b>Accept:</b> The firewall will accept packets that match the policy.<br><br><b>Monitor:</b> The firewall will monitor packets that match the policy. With this setting, each packet of an identified application protocol will have a corresponding Event Log entry.<br><br><b>Reset:</b> The firewall will drop packets that match the policy, and the session will be disconnected. With this setting, only the first packet of an identified application protocol will be recorded in Event Log. | Accept / Monitor / Reset      | Accept        |

## ADP

### Menu Path: Firewall > Advanced Protection > ADP





This page lets you configure your device's Anomaly Detection and Protection (ADP) parameters.

#### Note

Availability of this feature may vary depending on your product model and version.



Q Search

|   | Index   | Description  | Category   | Status  | Action  |
|---|---------|--|------------|---------|---------|
|  | 1000000 | Forbid multiple.   | Modbus/TCP | Enabled | Monitor |
|  | 1000001 | Specific layer 4 field of modbus request OR response is invalid. | Modbus/TCP | Enabled | Monitor |
|  | 1000002 | Address of the data to be accessed is invalid.                   | Modbus/TCP | Enabled | Monitor |
|  | 1000003 | Quantity of the data is invalid.                                 | Modbus/TCP | Enabled | Monitor |
|  | 1000004 | Data length indicated does not match the actual length.          | Modbus/TCP | Enabled | Monitor |

| UI Setting         | Description   |
|--------------------|---|
| <b>Index</b>       | Shows the index of the ADP rule.  |
| <b>Description</b> | Shows a description of the condition that will trigger the ADP rule.              |
| <b>Category</b>    | Shows the category of the ADP rule.   |
| <b>Status</b>      | Shows whether the ADP rule is enabled or disabled.                                |
| <b>Action</b>      | Shows the action the application firewall will take when the ADP rule is matched. |

## Edit ADP Rule Action

### Menu Path: Firewall > Advanced Protection > ADP

Clicking the **Edit** () icon for a rule on the **Insert > Path Here** page will open this dialog box. This dialog lets you modify an ADP rule. Click **APPLY** to save your changes.

### Edit ADP Index 1000001 Rule Action

Description  
Specific layer 4 field of modbus request OR response is invalid.

Status  
Enabled ▼

Action \*  
Monitor ▼

CANCEL
APPLY

| UI Setting                     | Description   | Valid Range              | Default Value |
|--------------------------------|---|--------------------------|---------------|
| <b>Description (View-only)</b> | Shows a description of the condition that will trigger the ADP rule.  | N/A                      | N/A           |
| <b>Status</b>                  | Enable or disable the ADP rule.   | Enabled / Disabled       | Enabled       |
| <b>Action</b>                  | Select the action to take for packets that match the rule.<br><b>Accept:</b> The firewall will accept packets that match the rule.<br><b>Monitor:</b> <a href="#">The firewall will monitor packets that match the rule and an event log will be recorded in Event Log - Firewall Log.</a><br><b>Reset:</b> The firewall will drop packets that match the rule, and the session will be disconnected. | Accept / Monitor / Reset | Monitor       |

## IPS

### Menu Path: Firewall > Advanced Protection > IPS

This page lets you configure the Intrusion Prevention System (IPS) feature, which helps protect against cyberthreats by performing pattern-based detection and blocking known attacks.

**Note**

Availability of this feature may vary depending on your product model and version.

**Note**

A separate IPS license is required to enable IPS functionality on the device.

**Note**

Starting from v9.0 of the Network Security Package, when the IPS license expires, existing IPS patterns can still be used for IPS protection. However, the IPS patterns will not be updated and will remain at their current versions when you update the Network Security Package.

| <input type="checkbox"/> | ID         | Name          | Status  | Category      | Severity | Action |
|--------------------------|------------|---------------|---------|---------------|----------|--------|
| <input type="checkbox"/> | 4026531840 | TCP SYN Flood | Enabled | Flooding&Scan | High     | Reset  |
| <input type="checkbox"/> | 4026531841 | TCP Flood     | Enabled | Flooding&Scan | High     | Reset  |
| <input type="checkbox"/> | 4026531842 | UDP Flood     | Enabled | Flooding&Scan | High     | Reset  |
| <input type="checkbox"/> | 4026531844 | ICMP Flood    | Enabled | Flooding&Scan | High     | Reset  |
| <input type="checkbox"/> | 4026531846 | IGMP Flood    | Enabled | Flooding&Scan | High     | Reset  |

| UI Setting      | Description   |
|-----------------|---|
| <b>ID</b>       | Shows the ID of the rule.                                       |
| <b>Name</b>     | Shows the name of the rule.                                     |
| <b>Status</b>   | Shows whether the rule is enabled or disabled.                  |
| <b>Category</b> | Shows the category of the rule.                                 |
| <b>Severity</b> | Shows the severity assigned to the rule.                        |
| <b>Action</b>   | Shows the action that will be taken when the rule is triggered. |

## Filter IPS Rules

### Menu Path: Firewall > Advanced Protection > IPS

Clicking the **Filter** (☰) icon on the **Firewall > Advanced Protection > IPS** page will open this dialog box. This dialog lets you filter the IPS Rule List according to various criteria. Click **APPLY** to apply the filter, or click **CLEAR** to reset all filter criteria.

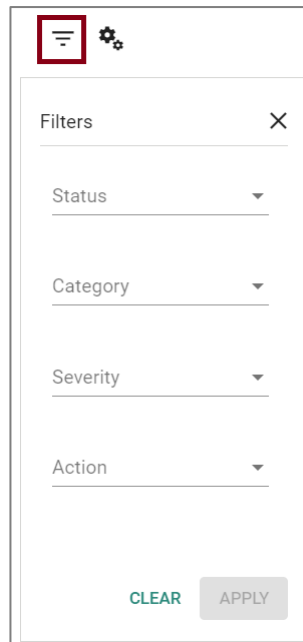

The dialog box is titled "Filters" and contains the following elements:

- Close button (X)
- Status dropdown menu
- Category dropdown menu
- Severity dropdown menu
- Action dropdown menu
- CLEAR button
- APPLY button

| UI Setting      | Description                           | Valid Range   | Default Value |
|-----------------|---------------------------------------|---|---------------|
| <b>Status</b>   | Filter for enabled or disabled rules. | Enabled / Disabled  | N/A           |
| <b>Category</b> | Filter for a specific rule category.  | File vulnerabilities / Buffer Overflow / DoS attacks / Exploits / Malware traffic / Reconnaissance / Web threats / Flooding & Scan / Protocol Attack Protection / IP Spoofing | N/A           |
| <b>Severity</b> | Filter for a specific severity level. | Information / Low / Medium / High / Critical  | N/A           |
| <b>Action</b>   | Filter for a specific rule action.    | Accept / Monitor / Reset  | N/A           |

## Quick Settings

**Menu Path: Firewall > Advanced Protection > IPS**

Clicking the **Settings (⚙️)** icon on the **Firewall > Advanced Protection > IPS** page will open this dialog box. This dialog lets you quickly configure many rules at the same time. Click **APPLY** to save your changes.

### Quick Settings

**Source**

All     Filter Rule     User Selected

**Filters**

Status ▾

Category ▾

Severity ▾

Action ▾

**Rule Settings**

Status \* ▾

Action \* ▾

CANCEL    **APPLY**

## Source

| UI Setting    | Description   | Valid Range                       | Default Value |
|---------------|---|-----------------------------------|---------------|
| <b>Source</b> | <p>Select which rules to modify with the <b>Rule Settings</b> you specify.</p> <p><b>All:</b> Modify all rules. This option will not be available if you selected rules in the IPS Rule List before opening this dialog.</p> <p><b>Filter Rule:</b> Only modify rules that match the filter criteria you specify. This option will not be available if you selected rules in the IPS Rule List before opening this dialog.</p> <p><b>User Selected:</b> Only modify the rules that you have selected using their checkboxes. This option is only available if you select rules in the IPS Rule List before opening this dialog.</p> | All / Filter Rule / User Selected | All           |

## Filters

(if **Source** is **Filter Rule**)

| UI Setting      | Description                           | Valid Range   | Default Value |
|-----------------|---------------------------------------|---|---------------|
| <b>Status</b>   | Filter for enabled or disabled rules. | Enabled / Disabled  | N/A           |
| <b>Category</b> | Filter for a specific rule category.  | File vulnerabilities / Buffer Overflow / DoS attacks / Exploits / Malware traffic / Reconnaissance / Web threats / Flooding & Scan / Protocol Attack Protection / IP Spoofing | N/A           |
| <b>Severity</b> | Filter for a specific severity level. | Information / Low / Medium / High / Critical  | N/A           |
| <b>Action</b>   | Filter for a specific rule action.    | Accept / Monitor / Reset  | N/A           |

## Rule Settings

| UI Setting    | Description                     | Valid Range        | Default Value |
|---------------|---------------------------------|--------------------|---------------|
| <b>Status</b> | Enable or disable the IPS rule. | Enabled / Disabled | Enabled       |

| UI Setting    | Description   | Valid Range              | Default Value |
|---------------|---|--------------------------|---------------|
| <b>Action</b> | Select the action to take for packets that match the rule.<br><b>Accept:</b> The firewall will accept packets that match the rule.<br><b>Monitor:</b> The firewall will monitor packets that match the rule.<br><b>Reset:</b> The firewall will drop packets that match the rule, and the session will be disconnected. | Accept / Monitor / Reset | Monitor       |

## Detailed Information

### Menu Path: Firewall > Advanced Protection > IPS

Clicking the **Detailed Information** (🔍) icon for a rule on the **Firewall > Advanced Protection > IPS** page will toggle display of a panel with detailed information about the rule.

**Intrusion Prevention System**

Search

| ID         | Name          | Status  | Category      | Severity | Act |
|------------|---------------|---------|---------------|----------|-----|
| 4026531840 | TCP SYN Flood | Enabled | Flooding&Scan | High     | Res |
| 4026531841 | TCP Flood     | Enabled | Flooding&Scan | High     | Res |
| 4026531842 | UDP Flood     | Enabled | Flooding&Scan | High     | Res |
| 4026531844 | ICMP Flood    | Enabled | Flooding&Scan | High     | Res |
| 4026531846 | IGMP Flood    | Enabled | Flooding&Scan | High     | Res |
| 4026531847 | IP Flood      | Enabled | Flooding&Scan | High     | Res |
| 4026531848 | TCP Port Scan | Enabled | Flooding&Scan | Medium   | Mo  |
| 4026531849 | UDP Port Scan | Enabled | Flooding&Scan | Medium   | Mo  |
| 4026531850 | IP Sweep      | Enabled | Flooding&Scan | Medium   | Mo  |

**IPS Rule Information**

**ICMP Flood**

Category  
Flooding&Scan

Severity  
High

Impact  
Denial of service

Reference  
MISC:RFC 792

Description  
An ICMP attack can come in many forms. There are 2 basic kinds, Flood and Nuke. An ICMP flood is usually accomplished by broadcasting either a bunch of ICMP ping packets (Not to be confused with IRC pings, which have a similar purpose, but are handled differently) or UDP packets (which are used in software like PointCast). The idea is, to send excessive data to the system, so that it gets slowed down to the point of being disconnected from IRC due to a ping timeout.

## Edit IPS Rule Action

### Menu Path: Firewall > Advanced Protection > IPS

Clicking the **Edit** (✎) icon for a rule on the **Firewall > Advanced Protection > IPS** page will open this dialog box. This dialog lets you modify an IPS rule. Click **APPLY** to save your changes.

### Edit IPS Rule Action

Name  
TCP SYN Flood

---

Status \*  
Enabled ▼

---

Action \*  
Reset ▼

---

CANCEL
APPLY

| UI Setting              | Description   | Valid Range              | Default Value |
|-------------------------|---|--------------------------|---------------|
| <b>Name (View-only)</b> | Shows the name of the IPS rule.   | N/A                      | N/A           |
| <b>Status</b>           | Enable or disable the IPS rule.   | Enabled / Disabled       | Enabled       |
| <b>Action</b>           | Select the action to take for packets that match the rule.<br><b>Accept:</b> The firewall will accept packets that match the rule.<br><b>Monitor:</b> The firewall will monitor packets that match the rule.<br><b>Reset:</b> The firewall will drop packets that match the rule, and the session will be disconnected. | Accept / Monitor / Reset | Monitor       |

## Device Lockdown

### Menu Path: Firewall > Device Lockdown

This page lets you configure Device Lockdown to secure and control network traffic.

Device Lockdown offers a straightforward method to automatically configure firewall whitelisting. Users are not required to know the device's IP or MAC address to set up firewall rules. The Learning function enables the device to gather device information from network traffic to establish whitelisting rules. Additionally, users can customize the learning table according to their needs.



**Note**

Device Lockdown is specifically designed for and is only available for NAT Series devices.

This page includes these tabs:

- Settings
- Learning Table

## Device Lockdown - Settings

**Menu Path: Firewall > Device Lockdown - Settings**

This page lets you manage the Device Lockdown feature.

### Learning Status

**Device Lockdown**

Settings    Learning Table

Learning Status

Boot Up

**START LEARNING**    STOP LEARNING

Status  
Disabled

Auto Learning on Startup    Learning Period \*  
Disabled    180  
30 - 86400    sec.

Interface

Lockdown Mode  
MAC Address

Log    Severity    Log Destination  
Disabled    Warning    Local Storage

**APPLY**

| UI Setting             | Description   |
|------------------------|---|
| <b>Learning Status</b> | <p>Shows the learning status for the Device Lockdown feature.</p> <p><b>START LEARNING:</b> Learn whitelist information from ARP tables through network traffic.</p> <div style="background-color: #f0f0f0; padding: 10px; margin: 10px 0;"> <p><b>Note</b></p> <p>When the Learning Status process is in progress, Device Lockdown cannot be enabled until the process is complete.</p> </div> <p><b>STOP LEARNING:</b> Stop the current learning process.</p> |

## Device Lockdown Settings

| UI Setting    | Description  | Valid Range        | Default Value |
|---------------|--|--------------------|---------------|
| <b>Status</b> | <p>Enable or disable device lockdown.</p> <div style="background-color: #f0f0f0; padding: 10px; margin: 10px 0;"> <p><b>Note</b></p> <p>When <b>Status</b> is enabled, the Learning Table can't be manually configured. Please disable <b>Status</b> to make modifications.</p> </div> | Enabled / Disabled | Disabled      |

| UI Setting                      | Description  | Valid Range   | Default Value |
|---------------------------------|--|---|---------------|
| <b>Auto Learning on Startup</b> | Enable or disable auto learning on startup.  | Enabled / Disabled  | Disabled      |
| <b>Learning Period</b>          | Specify the duration auto learning will be enabled for.  | 30 to 86400 seconds   | 180           |
| <b>Interface</b>                | Select an interface to lock down.  | Drop-down list of interfaces  | N/A           |
| <b>Lockdown Mode</b>            | Select the firewall filtering criteria.  | MAC Address / MAC+IP Access   | MAC Address   |
| <b>Log</b>                      | Enable or disable device lockdown event logs.  | Enabled / Disabled  | Disabled      |
| <b>Severity</b>                 | Select the severity of device lockdown events.   | Emergency / Alert / Critical / Error / Warning / Notice / Informational / Debug | Warning       |
| <b>Log Destination</b>          | Specify whether to store device lockdown event logs locally or send them to a syslog or trap server. | Local Storage / Syslog / Trap   | Local Storage |

## Device Lockdown - Learning Table

### Menu Path: Firewall > Device Lockdown - Learning Table

This page lets you view and manage the current learning table used for the Device Lockdown feature.

| Device Lockdown          |              |                    |            |                     |           |               |
|--------------------------|--------------|--------------------|------------|---------------------|-----------|---------------|
| Settings                 |              | Learning Table     |            |                     |           |               |
| + ↻                      |              | 🔍 Search           |            |                     |           |               |
| <input type="checkbox"/> | Description  | Network Access     | IP Address | MAC Address         | Interface | Entry Source  |
|                          | Default Rule | Block              | Any        | Any                 |           | Auto Learning |
| Max. 128                 |              | Items per page: 50 |            | 1 - 1 of 1  < < > > |           |               |

| UI Setting         | Description   |
|--------------------|---|
| <b>Description</b> | Shows the description used to identify the learning table rule. |

| UI Setting            | Description   |
|-----------------------|---|
| <b>Network Access</b> | Shows the network access rule to apply to the specified IP address or MAC address.<br><b>Allow:</b> Grants access to the specified IP address or MAC address.<br><b>Block:</b> Denies access to the specified IP address or MAC address.          |
| <b>IP Address</b>     | Shows the IP address the rule applies to. <b>Any</b> means it applies to all IP addresses.  |
| <b>MAC Address</b>    | Shows the MAC address the rule applies to. <b>Any</b> means it applies to all MAC addresses.  |
| <b>Interface</b>      | Shows the interface that the rule applies to.   |
| <b>Entry Source</b>   | Shows the source of the rule.<br><b>Manual Configuration:</b> The rule was manually created by a user.<br><b>Auto Learning:</b> The rule was created through the learning feature. Refer to <a href="#">Learning Status</a> for more information. |

## Delete Learning List

### Menu Path: Firewall > Device Lockdown - Learning Table

You can delete an entry by using the checkboxes to select the entries you want to delete, then clicking the **Delete (🗑)** icon.

| Device Lockdown                          |                |                |                   |           |                   |  |
|--|----------------|----------------|-------------------|-----------|-------------------|--|
| Settings                                 |                | Learning Table |                   |           |                   |  |
| Description                              | Network Access | IP Address     | MAC Address       | Interface | Entry From        |  |
| <input checked="" type="checkbox"/> Test | Allow          | 192.1.1.1      | aa:bb:cc:33:44:55 | LAN       | Manual Configured |  |
| <input type="checkbox"/> Default Rule    | Block          | Any            | Any               |           | Auto Learned      |  |

## Create Learning List

### Menu Path: Firewall > Device Lockdown - Learning Table

Clicking the **Add (➕)** icon on the **Firewall > Device Lockdown - Learning Table** page will open this dialog box. This dialog lets you manually create a new learning list entry.

Click **CREATE** to save your changes and add the new entry.

### Create Learning List Entry

Description 0 / 128

Network Access ▼

IP Address \*

MAC Address \*

Interface ▼

Entry Source  
Manual Configuration

CANCEL APPLY

| UI Setting            | Description  | Valid Range                  | Default Value |
|-----------------------|--|------------------------------|---------------|
| <b>Description</b>    | Specify a description to help identify the entry.  | Up to 128 characters         | N/A           |
| <b>Network Access</b> | Specify the network access rule to apply for this entry.<br><b>Allow:</b> Grants access to the specified IP address or MAC address.<br><b>Block:</b> Denies access to the specified IP address or MAC address. | Allow / Block                | N/A           |
| <b>IP Address</b>     | Specify the IP address the rule applies to.  | Valid IP address             | N/A           |
| <b>MAC Address</b>    | Specify the MAC address the rule applies to.   | Valid MAC address            | N/A           |
| <b>Interface</b>      | Specify the interface the rule applies to.   | Drop-down menu of interfaces | N/A           |

# VPN

## Menu Path: VPN

The VPN settings area lets you configure settings related to your device's VPN functionality.

This settings area includes these sections:

- IPsec
- L2TP Server
- OpenVPN Client

## VPN - User Privileges

Privileges to VPN settings are granted to the different authority levels as follows. Refer to [System > Account Management > User Accounts](#) for more information on user accounts.

| Settings              | Admin | Supervisor | User |
|-----------------------|-------|------------|------|
| <b>IPsec</b>          | R/W   | R/W        | R    |
| <b>L2TP Server</b>    | R/W   | R/W        | R    |
| <b>OpenVPN Client</b> | R/W   | R/W        | -    |

## IPSec

### Menu Path: VPN > IPSec

This page lets you set up IPSec VPN tunnels for your device.

This page includes these tabs:

- Global Settings
- IPSec Settings
- IPSec Status

## Global Settings

**Menu Path:** VPN > IPsec - Global Settings

This page lets you configure global settings that affect all IPsec tunnels.

The screenshot shows the 'IPSec' configuration page with the 'Global Settings' tab active. It contains four dropdown menus: 'Status \*' (Disabled), 'IPSec NAT-T \*' (Disabled), 'VPN Event Log \*' (Disabled), and 'Log Destination'. An 'APPLY' button is located at the bottom left of the configuration area.

| UI Setting             | Description  | Valid Range                   | Default Value |
|------------------------|--|-------------------------------|---------------|
| <b>Status</b>          | Enable or disable all IPsec VPN services.  | Enabled / Disabled            | Disabled      |
| <b>IPsec NAT-T</b>     | Enable or disable IPsec NAT-T (NAT-Traversal). This option should be enabled if there is an external industrial secure router located between VPN tunnels. | Enabled / Disabled            | Disabled      |
| <b>VPN Event Log</b>   | Enable or disable VPN event logging. Refer to <a href="#">Diagnostics &gt; Event Logs and Notifications &gt; Event Log</a> for more information.           | Enabled / Disabled            | Disabled      |
| <b>Log Destination</b> | If <b>VPN Event Log</b> is enabled, select the VPN event log storage location.   | Local Storage / Syslog / Trap | N/A           |

## IPsec Settings

**Menu Path:** VPN > IPsec - IPsec Settings

This page lets you create and edit IPsec VPN tunnels for your device.

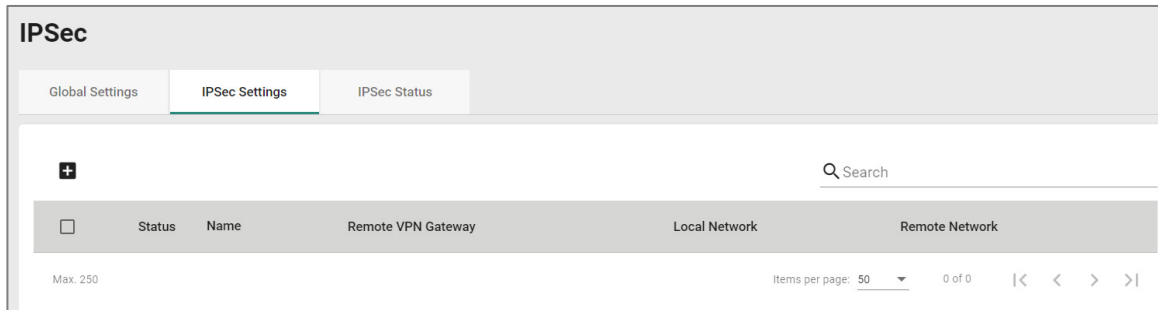

| UI Setting                | Description  |
|---------------------------|--|
| <b>Status</b>             | Shows whether the tunnel is enabled or disabled.               |
| <b>Name</b>               | Shows the name of the tunnel.                                  |
| <b>Remote VPN Gateway</b> | Shows the IP address of the remote VPN gateway for the tunnel. |
| <b>Local Network</b>      | Shows the tunnel's local network IP address.                   |
| <b>Remote Network</b>     | Shows the tunnel's remote network IP address.                  |

## Edit IPsec

### Menu Path: VPN > IPsec - IPsec Settings

Clicking the **Edit** (✎) icon for an entry on the **VPN > IPsec - IPsec Settings** page will open this dialog box. This dialog lets you edit an existing IPsec VPN tunnel. Click **APPLY** to save your changes.

### Edit IPsec - Quick Settings

If **Quick Settings** is selected, these settings will appear.



### Edit IPSec

Settings

Quick Settings
  Advanced Settings

#### Tunnel Settings

Status \*  Name \*  5 / 31

VPN Connection \*  Remote VPN Gateway \*

#### Remote Network List

+

| Remote Network *  | Netmask *  |
|---|--|
| <input type="checkbox"/> <input type="text" value="192.168.127.1"/> | <input type="text" value="24 (255.255.255.0)"/> <input type="text"/> |

Max. 10 1 - 1 of 1 |< < > >|

#### Security Settings

Simple
  Standard
  Strong

Authentication Mode \*  Pre-shared Key \*  8 / 64

## Tunnel Settings



| UI Setting    | Description                   | Valid Range        | Default Value |
|---------------|-------------------------------|--------------------|---------------|
| <b>Status</b> | Enable or disable the tunnel. | Enabled / Disabled | Enabled       |
| <b>Name</b>   | Enter a name for this tunnel. | Max. 31 characters | N/A           |

**Note**

Names must start with a character that is not a number.

| UI Setting                | Description  | Valid Range                      | Default Value |
|---------------------------|--|----------------------------------|---------------|
| <b>VPN Connection</b>     | Select the type of VPN connection to use for this rule.<br><b>Site to Site:</b> The VPN tunnel for the Local and Remote subnets is fixed.<br><b>Site to Site(Any):</b> The VPN tunnel for the Remote subnet area is dynamic and is fixed for the Local subnet. | Site to Site / Site to Site(Any) | Site to Site  |
| <b>Remote VPN Gateway</b> | Specify the IP address of the remote VPN gateway. If <b>VPN Connection</b> is set to <b>Site to Site(Any)</b> , this does not need to be set.  | Valid IP address                 | N/A           |

## Remote Network List

You can configure multiple remote networks for the tunnel. Click the add icon (  ) to add a new entry. Select an entry and click the delete icon (  ) to delete it.

### Limitations

You can add up to 10 remote networks for an IPSec VPN tunnel.

| UI Setting            | Description   | Valid Range                | Default Value         |
|-----------------------|---|----------------------------|-----------------------|
| <b>Remote Network</b> | Specify the IP address and subnet mask of the remote VPN network. | Valid IP address           | N/A                   |
| <b>Netmask</b>        | Select a netmask to use for the remote network.                   | Drop-down list of netmasks | 24<br>(255.255.255.0) |

## Security Settings

| UI Setting               | Description   | Valid Range | Default Value |             |        |       |                      |     |      |         |             |                |     |       |         |     |     |     |     |     |           |          |     |     |      |      |      |        |          |        |       |                      |     |      |         |             |      |     |       |         |     |     |     |     |     |           |                                    |        |
|--------------------------|---|-------------|---------------|-------------|--------|-------|----------------------|-----|------|---------|-------------|----------------|-----|-------|---------|-----|-----|-----|-----|-----|-----------|----------|-----|-----|------|------|------|--------|----------|--------|-------|----------------------|-----|------|---------|-------------|------|-----|-------|---------|-----|-----|-----|-----|-----|-----------|------------------------------------|--------|
| <b>Security Strength</b> | <p>Select the security strength for the tunnel. Different settings will change the <b>Encryption Algorithm</b> and <b>Hash Algorithm</b> used, which can be viewed in <b>Advanced Settings</b>.</p> <div style="border: 1px solid #ccc; background-color: #f9f9f9; padding: 10px; margin: 10px 0;"> <p><b>Note</b></p> <p>When creating an IPsec connection, it is highly recommended to use similar levels of algorithms between IPsec devices.</p> </div> <p>The different security levels use the following settings:</p> <p><b>Key Exchange 1</b></p> <table border="1" style="width: 100%; border-collapse: collapse;"> <thead> <tr> <th>Type</th> <th>Simple</th> <th>Standard</th> <th>Strong</th> <th>Extra</th> </tr> </thead> <tbody> <tr> <td>Encryption Algorithm</td> <td>DES</td> <td>3DES</td> <td>AES-256</td> <td>AES-256-GCM</td> </tr> <tr> <td>Hash Algorithm</td> <td>MD5</td> <td>SHA-1</td> <td>SHA-256</td> <td>N/A</td> </tr> <tr> <td>PRF</td> <td>N/A</td> <td>N/A</td> <td>N/A</td> <td>PRFSHA512</td> </tr> <tr> <td>DH Group</td> <td>DH1</td> <td>DH2</td> <td>DH14</td> <td>DH31</td> </tr> </tbody> </table> <p><b>Key Exchange 2</b></p> <table border="1" style="width: 100%; border-collapse: collapse;"> <thead> <tr> <th>Type</th> <th>Simple</th> <th>Standard</th> <th>Strong</th> <th>Extra</th> </tr> </thead> <tbody> <tr> <td>Encryption Algorithm</td> <td>DES</td> <td>3DES</td> <td>AES-256</td> <td>AES-256-GCM</td> </tr> <tr> <td>Hash</td> <td>MD5</td> <td>SHA-1</td> <td>SHA-256</td> <td>N/A</td> </tr> <tr> <td>PRF</td> <td>N/A</td> <td>N/A</td> <td>N/A</td> <td>prfsha512</td> </tr> </tbody> </table> | Type        | Simple        | Standard    | Strong | Extra | Encryption Algorithm | DES | 3DES | AES-256 | AES-256-GCM | Hash Algorithm | MD5 | SHA-1 | SHA-256 | N/A | PRF | N/A | N/A | N/A | PRFSHA512 | DH Group | DH1 | DH2 | DH14 | DH31 | Type | Simple | Standard | Strong | Extra | Encryption Algorithm | DES | 3DES | AES-256 | AES-256-GCM | Hash | MD5 | SHA-1 | SHA-256 | N/A | PRF | N/A | N/A | N/A | prfsha512 | Simple / Standard / Strong / Extra | Strong |
| Type                     | Simple  | Standard    | Strong        | Extra       |        |       |                      |     |      |         |             |                |     |       |         |     |     |     |     |     |           |          |     |     |      |      |      |        |          |        |       |                      |     |      |         |             |      |     |       |         |     |     |     |     |     |           |                                    |        |
| Encryption Algorithm     | DES   | 3DES        | AES-256       | AES-256-GCM |        |       |                      |     |      |         |             |                |     |       |         |     |     |     |     |     |           |          |     |     |      |      |      |        |          |        |       |                      |     |      |         |             |      |     |       |         |     |     |     |     |     |           |                                    |        |
| Hash Algorithm           | MD5   | SHA-1       | SHA-256       | N/A         |        |       |                      |     |      |         |             |                |     |       |         |     |     |     |     |     |           |          |     |     |      |      |      |        |          |        |       |                      |     |      |         |             |      |     |       |         |     |     |     |     |     |           |                                    |        |
| PRF                      | N/A   | N/A         | N/A           | PRFSHA512   |        |       |                      |     |      |         |             |                |     |       |         |     |     |     |     |     |           |          |     |     |      |      |      |        |          |        |       |                      |     |      |         |             |      |     |       |         |     |     |     |     |     |           |                                    |        |
| DH Group                 | DH1   | DH2         | DH14          | DH31        |        |       |                      |     |      |         |             |                |     |       |         |     |     |     |     |     |           |          |     |     |      |      |      |        |          |        |       |                      |     |      |         |             |      |     |       |         |     |     |     |     |     |           |                                    |        |
| Type                     | Simple  | Standard    | Strong        | Extra       |        |       |                      |     |      |         |             |                |     |       |         |     |     |     |     |     |           |          |     |     |      |      |      |        |          |        |       |                      |     |      |         |             |      |     |       |         |     |     |     |     |     |           |                                    |        |
| Encryption Algorithm     | DES   | 3DES        | AES-256       | AES-256-GCM |        |       |                      |     |      |         |             |                |     |       |         |     |     |     |     |     |           |          |     |     |      |      |      |        |          |        |       |                      |     |      |         |             |      |     |       |         |     |     |     |     |     |           |                                    |        |
| Hash                     | MD5   | SHA-1       | SHA-256       | N/A         |        |       |                      |     |      |         |             |                |     |       |         |     |     |     |     |     |           |          |     |     |      |      |      |        |          |        |       |                      |     |      |         |             |      |     |       |         |     |     |     |     |     |           |                                    |        |
| PRF                      | N/A   | N/A         | N/A           | prfsha512   |        |       |                      |     |      |         |             |                |     |       |         |     |     |     |     |     |           |          |     |     |      |      |      |        |          |        |       |                      |     |      |         |             |      |     |       |         |     |     |     |     |     |           |                                    |        |

| UI Setting                 | Description   | Valid Range                            | Default Value  |
|----------------------------|---|--|----------------|
| <b>Authentication Mode</b> | <p>Select the authentication mode to use for the tunnel.</p> <div style="background-color: #f0f0f0; padding: 5px; margin: 5px 0;"> <p> <b>Note</b></p> <p>You must have certificates already imported to select <b>X.509</b> or <b>X.509 With CA</b>. Refer to <a href="#">Certificate Management</a> for more information.</p> </div> <p><b>Pre-Shared Key:</b> Pre-Shared Key is a user-defined authentication string used by two systems to establish an IPsec VPN connection.</p> <p><b>X.509:</b> The local and remote systems will authenticate the VPN connection using certificates imported in advance by the user on the <b>Certificate Management &gt; Local Certificate</b> page.</p> <p><b>X.509 With CA:</b> The local and remote systems will authenticate the VPN connection using both certificates imported in advance by the user on the <b>Certificate Management &gt; Local Certificate</b> page and a CA certificate imported on the <b>Certificate Management &gt; Trusted CA Certificate</b> page.</p> | Pre-Shared Key / X.509 / X.509 With CA | Pre-Shared Key |
| <b>Pre-Shared Key</b>      | Specify a pre-shared key to use to authenticate the IPsec VPN connection.   | 0 to 64 characters                     | N/A            |

## Edit IPsec - Advanced Settings

If **Advanced Settings** is selected, these settings will appear.

### Edit IPSec

Settings

Quick Settings
  Advanced Settings

#### Tunnel Settings

Status \* Name \*

Enabled test1

5 / 31

L2TP Tunnel \*

Disabled

VPN Connection \* Remote VPN Gateway \* Startup Mode \*

Site to Site 10.1.1.2 Start in initial

#### Local Network List

+

Local Network \* Netmask \*

192.168.127.254 24 (255.255.255.0)

Max. 10 1 - 1 of 1 |< < > >|

#### Remote Network List

+

Remote Network \* Netmask \*

192.168.127.1 24 (255.255.255.0)

Max. 10 1 - 1 of 1 |< < > >|



CANCEL APPLY

## Tunnel Settings

| UI Setting    | Description                   | Valid Range        | Default Value |
|---------------|-------------------------------|--------------------|---------------|
| <b>Status</b> | Enable or disable the tunnel. | Enabled / Disabled | Enabled       |

| UI Setting                | Description   | Valid Range   | Default Value          |
|---------------------------|---|---|------------------------|
| <b>Name</b>               | Enter a name for this tunnel.<br><br><b>Note</b><br>Names must start with a character that is not a number.   | Max. 31 characters  | N/A                    |
| <b>L2TP Tunnel</b>        | Enable or disable L2TP over IPSec.  | Enabled / Disabled  | Disabled               |
| <b>VPN Connection</b>     | Select the type of VPN connection to use for this rule.<br><br><b>Site to Site:</b> The VPN tunnel for the Local and Remote subnets is fixed.<br><br><b>Site to Site(Any):</b> The VPN tunnel for the Remote subnet area is dynamic and is fixed for the Local subnet.  | Site to Site / Site to Site(Any)                          | Site to Site           |
| <b>Remote VPN Gateway</b> | Specify the IP address of the remote VPN gateway. If <b>VPN Connection</b> is set to <b>Site to Site(Any)</b> , this does not need to be set.   | Valid IP address  | N/A                    |
| <b>Startup Mode</b>       | Select a startup mode for the tunnel.<br><br><b>Initiate Automatically:</b> The VPN tunnel will actively initiate the connection with the remote VPN gateway to ensure the tunnel is always ready.<br><br><b>Wait for Connection:</b> The VPN tunnel will wait for the remote VPN gateway to initiate the connection.<br><br><b>Route Mode:</b> The VPN tunnel will only initiate a connection when routing packets are generated, and relies on traffic to trigger the tunnel. | Initiate Automatically / Wait for Connection / Route Mode | Initiate Automatically |



## Local Network List

You can configure multiple local networks for the tunnel. Click the add icon (  ) to add a new entry. Select an entry and click the delete icon (  ) to delete it.

| UI Setting   | Description  | Valid Range      | Default Value |
|--|--|------------------|---------------|
| <b>Limitations</b><br>You can add up to 10 local networks for an IPSec VPN tunnel. |  |                  |               |
| <b>Local Network</b>   | Specify the IP address and subnet mask of the local VPN network. | Valid IP address | N/A           |

| UI Setting     | Description                                    | Valid Range                | Default Value         |
|----------------|--|----------------------------|-----------------------|
| <b>Netmask</b> | Select a netmask to use for the local network. | Drop-down list of netmasks | 24<br>(255.255.255.0) |

## Remote Network List

You can configure multiple remote networks for the tunnel. Click the add icon (  ) to add a new entry. Select an entry and click the delete icon (  ) to delete it.

### Limitations

You can add up to 10 remote networks for an IPsec VPN tunnel.

| UI Setting            | Description   | Valid Range                | Default Value         |
|-----------------------|---|----------------------------|-----------------------|
| <b>Remote Network</b> | Specify the IP address and subnet mask of the remote VPN network. | Valid IP address           | N/A                   |
| <b>Netmask</b>        | Select a netmask to use for the remote network.                   | Drop-down list of netmasks | 24<br>(255.255.255.0) |

## Identity

| UI Setting  | Description  | Valid Range                                   | Default Value |
|---|--|---|---------------|
| <b>Identity Type</b>  | Select an ID type to use to identify VPN tunnel connections.<br><b>IP Address:</b> Use an IP address.<br><b>FQDN:</b> Use a Fully Qualified Domain Name (FQDN).<br><b>Key ID:</b> Use a user-defined key ID string.<br><b>Auto(with Cisco):</b> Use this when establishing connections to Cisco systems. | IP Address / FQDN / Key ID / Auto(with Cisco) | IP Address    |
| <b>Local ID (If Identity Type is IP Address, FQDN, or Key ID)</b> | Specify the local ID for identifying the VPN tunnel connection.<br>The Local ID must be identical to the Remote ID of the connected VPN gateway in order to successfully establish the VPN tunnel connection.  | 1 to 31 characters                            | N/A           |

| UI Setting   | Description  | Valid Range        | Default Value |
|--|--|--------------------|---------------|
| <b>Remote ID</b><br><b>(If Identity Type is IP Address, FQDN, or Key ID)</b> | Specify the remote ID for identifying the VPN tunnel connection.<br><br>The Remote ID must be identical to the Local ID of the connected VPN gateway in order to successfully establish the VPN tunnel connection. | 1 to 31 characters | N/A           |

### Key Exchange (Phase 1)

| UI Setting         | Description   | Valid Range       | Default Value |
|--------------------|---|-------------------|---------------|
| <b>IKE Mode</b>    | Select the IKE mode to use for authentication.<br><br><b>Main:</b> Both the remote and local VPN gateway will negotiate which encryption/hash algorithm and DH groups can be used for this VPN tunnel. Both VPN gateways must use the same algorithm to communicate.<br><br><b>Aggressive:</b> The remote and local VPN gateways will not negotiate the algorithm and will only use the user-defined configuration. | Main / Aggressive | Main          |
| <b>IKE Version</b> | Select which version of IKE to use.<br><br><b>IKE1:</b> Use IKE Version 1 protocol.<br><b>IKE2:</b> Use IKE Version 2 protocol.   | IKE1 / IKE2       | IKE2          |



| UI Setting   | Description   | Valid Range  | Default Value  |
|--|---|--|----------------|
| <b>Authentication Mode</b>   | <p>Select the authentication mode to use for the tunnel.</p> <div style="background-color: #f0f0f0; padding: 10px; margin: 10px 0;"> <p> <b>Note</b></p> <p>You must have certificates already imported to select <b>X.509</b> or <b>X.509 With CA</b>. Refer to <a href="#">Certificate Management</a> for more information.</p> </div> <p><b>Pre-Shared Key:</b> Pre-Shared Key is a user-defined authentication string used by two systems to establish an IPsec VPN connection.</p> <p><b>X.509:</b> The local and remote systems will authenticate the VPN connection using certificates imported in advance by the user on the <b>Certificate Management &gt; Local Certificate</b> page.</p> <p><b>X.509 With CA:</b> The local and remote systems will authenticate the VPN connection using both certificates imported in advance by the user on the <b>Certificate Management &gt; Local Certificate</b> page and a CA certificate imported on the <b>Certificate Management &gt; Trusted CA Certificate</b> page.</p> | Pre-Shared Key / X.509 / X.509 With CA                 | Pre-Shared Key |
| <b>Pre-Shared Key</b>  | Specify a pre-shared key to use to authenticate the IPsec VPN connection.   | 0 to 64 characters                                     |                |
| <b>Encryption Algorithm</b>  | Select the encryption algorithm to use for key exchange.  | DES / 3DES / AES-128 / AES-192 / AES-256 / AES-256-GCM | AES-256        |
| <b>Hash Algorithm (If Encryption Algorithm is not AES-256-GCM)</b> | Select the hash algorithm to use for key exchange.  | MD5 / SHA-1 / SHA-256 / SHA-512                        | SHA-256        |
| <b>PRF (If Encryption Algorithm is AES-256-GCM)</b>                | Select the PRF algorithm for AES-256-GCM.   | PRFSHA256 / PRFSHA384 / PRFSHA512                      | PRFSHA256      |

| UI Setting          | Description  | Valid Range  | Default Value   |
|---------------------|--|--|-----------------|
| <b>DH Group</b>     | Select the Diffie-Hellman group. This is the key exchange group between the remote and VPN gateways. | DH 1(modp768) / DH 2(modp1024) / DH 5(modp1536) / DH 14(modp2048) /DH15 (modp3072) / DH16 (modp4096) / DH17 (modp6144) / DH18 (modp8192) / DH22 (modp1024s160) / DH23 (modp2048s224) / DH24 (modp2048s256) / DH31 (curve25519) | DH 14(modp2048) |
| <b>IKE Lifetime</b> | Specify the lifetime (in minutes) for IKE SA.  | 30 to 43200  | 43200           |

## Data Exchange (Phase 2)

| UI Setting   | Description  | Valid Range  | Default Value |
|--|--|--|---------------|
| <b>Encryption Algorithm</b>  | Select the encryption algorithm to use for data exchange.  | DES / 3DES / AES-128 / AES-192 / AES-256 / AES-256-GCM | AES-256       |
| <b>Hash Algorithm</b><br><b>(If Encryption Algorithm is not AES-256-GCM)</b> | Select the hash algorithm to use for data exchange.  | MD5 / SHA-1 / SHA-256 / SHA-512                        | SHA-256       |
| <b>PRF</b><br><b>(If Encryption Algorithm is AES-256-GCM)</b>                | Select the PRF algorithm for AES-256-GCM.  | PRFSHA256 / PRFSHA384 / PRFSHA512                      | PRFSHA256     |
| <b>Perfect Forward Secrecy</b>   | Enable or disable Perfect Forward Secrecy. When enabled, different security keys are used for different IPsec phases in order to enhance security. | Enabled / Disabled                                     | Disabled      |

| UI Setting  | Description  | Valid Range  | Default Value    |
|---|--|--|------------------|
| <b>DH Group (If Perfect Forward Secrecy is Enabled)</b> | Select the Diffie-Hellman group. This is the Key Exchange group between the remote and VPN gateways. | DH 1(modp768) / DH 2(modp1024) / DH 5(modp1536) / DH 14(modp2048) /DH15 (modp3072) / DH16 (modp4096) / DH17 (modp6144) / DH18 (modp8192) / DH22 (modp1024s160) / DH23 (modp2048s224) / DH24 (modp2048s256) / DH31 (curve25519) | DH 14 (modp2048) |
| <b>SA Lifetime</b>                                      | Specify the lifetime (in minutes) for Phase 2 IKE SA.  | 30 to 43200  | 43200            |

## Dead Peer Detection

| UI Setting                 | Description   | Valid Range                       | Default Value |
|----------------------------|---|-----------------------------------|---------------|
| <b>Action</b>              | Specify the action the system should take when a dead peer is detected.<br><b>Hold:</b> Maintain the VPN tunnel.<br><b>Restart:</b> Reconnect the VPN tunnel.<br><b>Clear:</b> Clear the VPN tunnel.<br><b>Disabled:</b> Disable Dead Peer Detection. | Hold / Restart / Clear / Disabled | Restart       |
| <b>Retry Interval</b>      | Specify the interval (in seconds) at which Dead Peer Detection messages are sent.   | 0 to 3600                         | 30            |
| <b>Confidence Interval</b> | Specify the interval (in seconds) at which the system will check to see if the connection is alive or not.  | 0 to 3600                         | 120           |

## Create IPsec

### Menu Path: VPN > IPsec - IPsec Settings

Clicking the **Add (+)** icon on the **VPN > IPsec - IPsec Settings** page will open this dialog box. This dialog lets you create a new IPsec VPN tunnel. Click **CREATE** to save your changes and add the new tunnel.

### Create IPsec - Quick Settings

If **Quick Settings** is selected, these settings will appear.

### Create IPsec

Settings

Quick Settings    Advanced Settings

---

#### Tunnel Settings

Status \*

Enabled ▾   Name \* 0 / 31

---

VPN Connection \*

Site to Site ▾   Remote VPN Gateway \*

---

#### Remote Network List

+

Required

Max. 10 0 of 0   |< < > >|

---

#### Security Settings

Simple    Standard    Strong    Extra

Authentication Mode \*



Pre-shared Key ▾   Pre-shared Key \* 0 / 64

CANCEL
CREATE

## Tunnel Settings

| UI Setting                | Description  | Valid Range                      | Default Value |
|---------------------------|--|----------------------------------|---------------|
| <b>Status</b>             | Enable or disable the tunnel.  | Enabled / Disabled               | Enabled       |
| <b>Name</b>               | Enter a name for this tunnel.<br><br><div style="background-color: #f0f0f0; padding: 5px; margin-top: 10px;"> <p> <b>Note</b><br/>Names must start with a character that is not a number.</p> </div>   | Max. 31 characters               | N/A           |
| <b>VPN Connection</b>     | Select the type of VPN connection to use for this rule.<br><b>Site to Site:</b> The VPN tunnel for the Local and Remote subnets is fixed.<br><b>Site to Site(Any):</b> The VPN tunnel for the Remote subnet area is dynamic and is fixed for the Local subnet. | Site to Site / Site to Site(Any) | Site to Site  |
| <b>Remote VPN Gateway</b> | Specify the IP address of the remote VPN gateway. If <b>VPN Connection</b> is set to <b>Site to Site(Any)</b> , this does not need to be set.  | Valid IP address                 | N/A           |

## Remote Network List

You can configure multiple remote networks for the tunnel. Click the add icon (  ) to add a new entry. Select an entry and click the delete icon (  ) to delete it.

### Limitations

You can add up to 10 remote networks for an IPSec VPN tunnel.

| UI Setting            | Description   | Valid Range                | Default Value         |
|-----------------------|---|----------------------------|-----------------------|
| <b>Remote Network</b> | Specify the IP address and subnet mask of the remote VPN network. | Valid IP address           | N/A                   |
| <b>Netmask</b>        | Select a netmask to use for the remote network.                   | Drop-down list of netmasks | 24<br>(255.255.255.0) |

## Security Settings

| UI Setting               | Description  | Valid Range | Default Value |             |        |       |                      |     |      |         |             |                |     |       |         |     |     |     |     |     |           |          |     |     |      |      |      |        |          |        |       |                      |     |      |         |             |      |     |       |         |     |     |     |     |     |           |                                    |        |
|--------------------------|--|-------------|---------------|-------------|--------|-------|----------------------|-----|------|---------|-------------|----------------|-----|-------|---------|-----|-----|-----|-----|-----|-----------|----------|-----|-----|------|------|------|--------|----------|--------|-------|----------------------|-----|------|---------|-------------|------|-----|-------|---------|-----|-----|-----|-----|-----|-----------|------------------------------------|--------|
| <b>Security Strength</b> | <p>Select the security strength for the tunnel. Different settings will change the <b>Encryption Algorithm</b> and <b>Hash Algorithm</b> used, which can be viewed in <b>Advanced Settings</b>.</p> <div style="border: 1px solid #ccc; padding: 5px; margin: 10px 0;"> <p> <b>Note</b></p> <p>When creating an IPsec connection, it is highly recommended to use similar levels of algorithms between IPsec devices.</p> </div> <p>The different security levels use the following settings:</p> <p><b>Key Exchange 1</b></p> <table border="1" data-bbox="416 786 1118 1205"> <thead> <tr> <th>Type</th> <th>Simple</th> <th>Standard</th> <th>Strong</th> <th>Extra</th> </tr> </thead> <tbody> <tr> <td>Encryption Algorithm</td> <td>DES</td> <td>3DES</td> <td>AES-256</td> <td>AES-256-GCM</td> </tr> <tr> <td>Hash Algorithm</td> <td>MD5</td> <td>SHA-1</td> <td>SHA-256</td> <td>N/A</td> </tr> <tr> <td>PRF</td> <td>N/A</td> <td>N/A</td> <td>N/A</td> <td>PRFSHA512</td> </tr> <tr> <td>DH Group</td> <td>DH1</td> <td>DH2</td> <td>DH14</td> <td>DH31</td> </tr> </tbody> </table> <p><b>Key Exchange 2</b></p> <table border="1" data-bbox="416 1263 1118 1610"> <thead> <tr> <th>Type</th> <th>Simple</th> <th>Standard</th> <th>Strong</th> <th>Extra</th> </tr> </thead> <tbody> <tr> <td>Encryption Algorithm</td> <td>DES</td> <td>3DES</td> <td>AES-256</td> <td>AES-256-GCM</td> </tr> <tr> <td>Hash</td> <td>MD5</td> <td>SHA-1</td> <td>SHA-256</td> <td>N/A</td> </tr> <tr> <td>PRF</td> <td>N/A</td> <td>N/A</td> <td>N/A</td> <td>prfsha512</td> </tr> </tbody> </table> | Type        | Simple        | Standard    | Strong | Extra | Encryption Algorithm | DES | 3DES | AES-256 | AES-256-GCM | Hash Algorithm | MD5 | SHA-1 | SHA-256 | N/A | PRF | N/A | N/A | N/A | PRFSHA512 | DH Group | DH1 | DH2 | DH14 | DH31 | Type | Simple | Standard | Strong | Extra | Encryption Algorithm | DES | 3DES | AES-256 | AES-256-GCM | Hash | MD5 | SHA-1 | SHA-256 | N/A | PRF | N/A | N/A | N/A | prfsha512 | Simple / Standard / Strong / Extra | Strong |
| Type                     | Simple   | Standard    | Strong        | Extra       |        |       |                      |     |      |         |             |                |     |       |         |     |     |     |     |     |           |          |     |     |      |      |      |        |          |        |       |                      |     |      |         |             |      |     |       |         |     |     |     |     |     |           |                                    |        |
| Encryption Algorithm     | DES  | 3DES        | AES-256       | AES-256-GCM |        |       |                      |     |      |         |             |                |     |       |         |     |     |     |     |     |           |          |     |     |      |      |      |        |          |        |       |                      |     |      |         |             |      |     |       |         |     |     |     |     |     |           |                                    |        |
| Hash Algorithm           | MD5  | SHA-1       | SHA-256       | N/A         |        |       |                      |     |      |         |             |                |     |       |         |     |     |     |     |     |           |          |     |     |      |      |      |        |          |        |       |                      |     |      |         |             |      |     |       |         |     |     |     |     |     |           |                                    |        |
| PRF                      | N/A  | N/A         | N/A           | PRFSHA512   |        |       |                      |     |      |         |             |                |     |       |         |     |     |     |     |     |           |          |     |     |      |      |      |        |          |        |       |                      |     |      |         |             |      |     |       |         |     |     |     |     |     |           |                                    |        |
| DH Group                 | DH1  | DH2         | DH14          | DH31        |        |       |                      |     |      |         |             |                |     |       |         |     |     |     |     |     |           |          |     |     |      |      |      |        |          |        |       |                      |     |      |         |             |      |     |       |         |     |     |     |     |     |           |                                    |        |
| Type                     | Simple   | Standard    | Strong        | Extra       |        |       |                      |     |      |         |             |                |     |       |         |     |     |     |     |     |           |          |     |     |      |      |      |        |          |        |       |                      |     |      |         |             |      |     |       |         |     |     |     |     |     |           |                                    |        |
| Encryption Algorithm     | DES  | 3DES        | AES-256       | AES-256-GCM |        |       |                      |     |      |         |             |                |     |       |         |     |     |     |     |     |           |          |     |     |      |      |      |        |          |        |       |                      |     |      |         |             |      |     |       |         |     |     |     |     |     |           |                                    |        |
| Hash                     | MD5  | SHA-1       | SHA-256       | N/A         |        |       |                      |     |      |         |             |                |     |       |         |     |     |     |     |     |           |          |     |     |      |      |      |        |          |        |       |                      |     |      |         |             |      |     |       |         |     |     |     |     |     |           |                                    |        |
| PRF                      | N/A  | N/A         | N/A           | prfsha512   |        |       |                      |     |      |         |             |                |     |       |         |     |     |     |     |     |           |          |     |     |      |      |      |        |          |        |       |                      |     |      |         |             |      |     |       |         |     |     |     |     |     |           |                                    |        |

| UI Setting                 | Description   | Valid Range                            | Default Value  |
|----------------------------|---|--|----------------|
| <b>Authentication Mode</b> | <p>Select the authentication mode to use for the tunnel.</p> <div style="background-color: #f0f0f0; padding: 5px; margin: 5px 0;"> <p> <b>Note</b></p> <p>You must have certificates already imported to select <b>X.509</b> or <b>X.509 With CA</b>. Refer to <a href="#">Certificate Management</a> for more information.</p> </div> <p><b>Pre-Shared Key:</b> Pre-Shared Key is a user-defined authentication string used by two systems to establish an IPsec VPN connection.</p> <p><b>X.509:</b> The local and remote systems will authenticate the VPN connection using certificates imported in advance by the user on the <b>Certificate Management &gt; Local Certificate</b> page.</p> <p><b>X.509 With CA:</b> The local and remote systems will authenticate the VPN connection using both certificates imported in advance by the user on the <b>Certificate Management &gt; Local Certificate</b> page and a CA certificate imported on the <b>Certificate Management &gt; Trusted CA Certificate</b> page.</p> | Pre-Shared Key / X.509 / X.509 With CA | Pre-Shared Key |
| <b>Pre-Shared Key</b>      | Specify a pre-shared key to use to authenticate the IPsec VPN connection.   | 0 to 64 characters                     | N/A            |

## Create IPsec - Advanced Settings

If **Advanced Settings** is selected, these settings will appear.

### Create IPSec Connection

Settings

Quick Settings
  Advanced Settings

#### Tunnel Settings

Status \*  
 Enabled  Name \*  0 / 31

L2TP Tunnel \*  
 Disabled

VPN Connection \*  
 Site to Site  Remote VPN Gateway \*  Startup Mode \*  
 Initiate Automatically

#### Local Network List

| Local Network *                          | Netmask *                               |
|--|---|
| <input type="checkbox"/> 192.168.127.254 | 24 (255.255.255.0) <input type="text"/> |

Max. 10 1 - 1 of 1 |< < > >|

#### Remote Network List

Required

Max. 10 0 of 0 |< < > >|

Identity Type \*  
 IP Address  Local ID  Remote ID   
0 / 31 0 / 31



## Tunnel Settings

| UI Setting    | Description                   | Valid Range        | Default Value |
|---------------|-------------------------------|--------------------|---------------|
| <b>Status</b> | Enable or disable the tunnel. | Enabled / Disabled | Enabled       |



| UI Setting                | Description   | Valid Range   | Default Value          |
|---------------------------|---|---|------------------------|
| <b>Name</b>               | Enter a name for this tunnel.<br><br><div style="background-color: #f0f0f0; padding: 5px; border: 1px solid #ccc;"> <p> <b>Note</b><br/>Names must start with a character that is not a number.</p> </div>   | Max. 31 characters  | N/A                    |
| <b>L2TP Tunnel</b>        | Enable or disable L2TP over IPSec.  | Enabled / Disabled  | Disabled               |
| <b>VPN Connection</b>     | Select the type of VPN connection to use for this rule.<br><br><b>Site to Site:</b> The VPN tunnel for the Local and Remote subnets is fixed.<br><br><b>Site to Site(Any):</b> The VPN tunnel for the Remote subnet area is dynamic and is fixed for the Local subnet.  | Site to Site / Site to Site(Any)                          | Site to Site           |
| <b>Remote VPN Gateway</b> | Specify the IP address of the remote VPN gateway. If <b>VPN Connection</b> is set to <b>Site to Site(Any)</b> , this does not need to be set.   | Valid IP address  | N/A                    |
| <b>Startup Mode</b>       | Select a startup mode for the tunnel.<br><br><b>Initiate Automatically:</b> The VPN tunnel will actively initiate the connection with the remote VPN gateway to ensure the tunnel is always ready.<br><br><b>Wait for Connection:</b> The VPN tunnel will wait for the remote VPN gateway to initiate the connection.<br><br><b>Route Mode:</b> The VPN tunnel will only initiate a connection when routing packets are generated, and relies on traffic to trigger the tunnel. | Initiate Automatically / Wait for Connection / Route Mode | Initiate Automatically |

## Local Network List



You can configure multiple local networks for the tunnel. Click the add icon (  ) to add a new entry. Select an entry and click the delete icon (  ) to delete it.

 **Limitations**  
You can add up to 10 local networks for an IPSec VPN tunnel.

| UI Setting           | Description  | Valid Range      | Default Value |
|----------------------|--|------------------|---------------|
| <b>Local Network</b> | Specify the IP address and subnet mask of the local VPN network. | Valid IP address | N/A           |

| UI Setting     | Description                                    | Valid Range                | Default Value         |
|----------------|--|----------------------------|-----------------------|
| <b>Netmask</b> | Select a netmask to use for the local network. | Drop-down list of netmasks | 24<br>(255.255.255.0) |

## Remote Network List

You can configure multiple remote networks for the tunnel. Click the add icon (  ) to add a new entry. Select an entry and click the delete icon (  ) to delete it.

### Limitations

You can add up to 10 remote networks for an IPsec VPN tunnel.

| UI Setting            | Description   | Valid Range                | Default Value         |
|-----------------------|---|----------------------------|-----------------------|
| <b>Remote Network</b> | Specify the IP address and subnet mask of the remote VPN network. | Valid IP address           | N/A                   |
| <b>Netmask</b>        | Select a netmask to use for the remote network.                   | Drop-down list of netmasks | 24<br>(255.255.255.0) |

## Identity

| UI Setting  | Description  | Valid Range                                   | Default Value |
|---|--|---|---------------|
| <b>Identity Type</b>  | Select an ID type to use to identify VPN tunnel connections.<br><b>IP Address:</b> Use an IP address.<br><b>FQDN:</b> Use a Fully Qualified Domain Name (FQDN).<br><b>Key ID:</b> Use a user-defined key ID string.<br><b>Auto(with Cisco):</b> Use this when establishing connections to Cisco systems. | IP Address / FQDN / Key ID / Auto(with Cisco) | IP Address    |
| <b>Local ID (If Identity Type is IP Address, FQDN, or Key ID)</b> | Specify the local ID for identifying the VPN tunnel connection.<br>The Local ID must be identical to the Remote ID of the connected VPN gateway in order to successfully establish the VPN tunnel connection.  | 1 to 31 characters                            | N/A           |

| UI Setting   | Description  | Valid Range        | Default Value |
|--|--|--------------------|---------------|
| <b>Remote ID</b><br><b>(If Identity Type is IP Address, FQDN, or Key ID)</b> | Specify the remote ID for identifying the VPN tunnel connection.<br><br>The Remote ID must be identical to the Local ID of the connected VPN gateway in order to successfully establish the VPN tunnel connection. | 1 to 31 characters | N/A           |

### Key Exchange (Phase 1)

| UI Setting         | Description   | Valid Range       | Default Value |
|--------------------|---|-------------------|---------------|
| <b>IKE Mode</b>    | Select the IKE mode to use for authentication.<br><br><b>Main:</b> Both the remote and local VPN gateway will negotiate which encryption/hash algorithm and DH groups can be used for this VPN tunnel. Both VPN gateways must use the same algorithm to communicate.<br><br><b>Aggressive:</b> The remote and local VPN gateways will not negotiate the algorithm and will only use the user-defined configuration. | Main / Aggressive | Main          |
| <b>IKE Version</b> | Select which version of IKE to use.<br><br><b>IKE1:</b> Use IKE Version 1 protocol.<br><b>IKE2:</b> Use IKE Version 2 protocol.   | IKE1 / IKE2       | IKE2          |

| UI Setting   | Description   | Valid Range  | Default Value  |
|--|---|--|----------------|
| <b>Authentication Mode</b>   | <p>Select the authentication mode to use for the tunnel.</p> <div style="background-color: #f0f0f0; padding: 10px; margin: 10px 0;"> <p><b>Note</b></p> <p>You must have certificates already imported to select <b>X.509</b> or <b>X.509 With CA</b>. Refer to <a href="#">Certificate Management</a> for more information.</p> </div> <p><b>Pre-Shared Key:</b> Pre-Shared Key is a user-defined authentication string used by two systems to establish an IPsec VPN connection.</p> <p><b>X.509:</b> The local and remote systems will authenticate the VPN connection using certificates imported in advance by the user on the <b>Certificate Management &gt; Local Certificate</b> page.</p> <p><b>X.509 With CA:</b> The local and remote systems will authenticate the VPN connection using both certificates imported in advance by the user on the <b>Certificate Management &gt; Local Certificate</b> page and a CA certificate imported on the <b>Certificate Management &gt; Trusted CA Certificate</b> page.</p> | Pre-Shared Key / X.509 / X.509 With CA                 | Pre-Shared Key |
| <b>Pre-Shared Key</b>  | Specify a pre-shared key to use to authenticate the IPsec VPN connection.   | 0 to 64 characters                                     |                |
| <b>Encryption Algorithm</b>  | Select the encryption algorithm to use for key exchange.  | DES / 3DES / AES-128 / AES-192 / AES-256 / AES-256-GCM | AES-256        |
| <b>Hash Algorithm (If Encryption Algorithm is not AES-256-GCM)</b> | Select the hash algorithm to use for key exchange.  | MD5 / SHA-1 / SHA-256 / SHA-512                        | SHA-256        |
| <b>PRF (If Encryption Algorithm is AES-256-GCM)</b>                | Select the PRF algorithm for AES-256-GCM.   | PRFSHA256 / PRFSHA384 / PRFSHA512                      | PRFSHA256      |

| UI Setting          | Description  | Valid Range  | Default Value   |
|---------------------|--|--|-----------------|
| <b>DH Group</b>     | Select the Diffie-Hellman group. This is the key exchange group between the remote and VPN gateways. | DH 1(modp768) / DH 2(modp1024) / DH 5(modp1536) / DH 14(modp2048) /DH15 (modp3072) / DH16 (modp4096) / DH17 (modp6144) / DH18 (modp8192) / DH22 (modp1024s160) / DH23 (modp2048s224) / DH24 (modp2048s256) / DH31 (curve25519) | DH 14(modp2048) |
| <b>IKE Lifetime</b> | Specify the lifetime (in minutes) for IKE SA.  | 30 to 43200  | 43200           |

## Data Exchange (Phase 2)

| UI Setting   | Description  | Valid Range  | Default Value |
|--|--|--|---------------|
| <b>Encryption Algorithm</b>  | Select the encryption algorithm to use for data exchange.  | DES / 3DES / AES-128 / AES-192 / AES-256 / AES-256-GCM | AES-256       |
| <b>Hash Algorithm</b><br><b>(If Encryption Algorithm is not AES-256-GCM)</b> | Select the hash algorithm to use for data exchange.  | MD5 / SHA-1 / SHA-256 / SHA-512                        | SHA-256       |
| <b>PRF</b><br><b>(If Encryption Algorithm is AES-256-GCM)</b>                | Select the PRF algorithm for AES-256-GCM.  | PRFSHA256 / PRFSHA384 / PRFSHA512                      | PRFSHA256     |
| <b>Perfect Forward Secrecy</b>   | Enable or disable Perfect Forward Secrecy. When enabled, different security keys are used for different IPsec phases in order to enhance security. | Enabled / Disabled                                     | Disabled      |

| UI Setting  | Description  | Valid Range  | Default Value    |
|---|--|--|------------------|
| <b>DH Group (If Perfect Forward Secrecy is Enabled)</b> | Select the Diffie-Hellman group. This is the Key Exchange group between the remote and VPN gateways. | DH 1(modp768) / DH 2(modp1024) / DH 5(modp1536) / DH 14(modp2048) /DH15 (modp3072) / DH16 (modp4096) / DH17 (modp6144) / DH18 (modp8192) / DH22 (modp1024s160) / DH23 (modp2048s224) / DH24 (modp2048s256) / DH31 (curve25519) | DH 14 (modp2048) |
| <b>SA Lifetime</b>                                      | Specify the lifetime (in minutes) for Phase 2 IKE SA.  | 30 to 43200  | 43200            |

## Dead Peer Detection

| UI Setting                 | Description   | Valid Range                       | Default Value |
|----------------------------|---|-----------------------------------|---------------|
| <b>Action</b>              | Specify the action the system should take when a dead peer is detected.<br><b>Hold:</b> Maintain the VPN tunnel.<br><b>Restart:</b> Reconnect the VPN tunnel.<br><b>Clear:</b> Clear the VPN tunnel.<br><b>Disabled:</b> Disable Dead Peer Detection. | Hold / Restart / Clear / Disabled | Restart       |
| <b>Retry Interval</b>      | Specify the interval (in seconds) at which Dead Peer Detection messages are sent.   | 0 to 3600                         | 30            |
| <b>Confidence Interval</b> | Specify the interval (in seconds) at which the system will check to see if the connection is alive or not.  | 0 to 3600                         | 120           |

## Delete IPSec

### Menu Path: VPN > IPSec - IPSec Settings

You can delete tunnels by using the checkboxes to select the entries you want to delete, then clicking the **Delete** (  ) icon.

| <input checked="" type="checkbox"/> | Status  | Name  | Remote VPN Gateway | Local Network      | Remote Network   |
|-------------------------------------|---------|-------|--------------------|--------------------|------------------|
| <input checked="" type="checkbox"/> | Enabled | test1 | 10.1.1.2           | 192.168.127.254/24 | 192.168.127.1/24 |

Max. 250      Items per page: 50      1 – 1 of 1      << < > >>

## IPSec Status

### Menu Path: VPN > IPSec - IPSec Status

This page lets you see the status of your IPSec VPN tunnels.

| Name  | Local Network      | Local Gateway | Remote Network   | Remote Gateway | Key Exchange (Phase 1) | Data Exchange (Phase 2) | Time     |
|-------|--------------------|---------------|------------------|----------------|------------------------|-------------------------|----------|
| test1 | 192.168.127.254/24 | 10.123.13.33  | 192.168.127.1/24 | 10.1.1.2       |                        |                         | 0h:0m:0s |

Items per page: 50      0 of 0      << < > >>

| UI Setting                     | Description                                      |
|--------------------------------|--|
| <b>Name</b>                    | Shows the name of the tunnel.                    |
| <b>Local Network</b>           | Shows the local network address for the tunnel.  |
| <b>Local Gateway</b>           | Shows the local gateway address for the tunnel.  |
| <b>Remote Network</b>          | Shows the remote network address for the tunnel. |
| <b>Remote Gateway</b>          | Shows the remote gateway address for the tunnel. |
| <b>Key Exchange (Phase 1)</b>  | Shows the status of key exchange phase.          |
| <b>Data Exchange (Phase 2)</b> | Shows the status of the data exchange phase.     |
| <b>Time</b>                    | Shows how long the connection has been up.       |

# L2TP Server

## Menu Path: VPN > L2TP Server

This page lets you configure the L2TP server function of your device. L2TP is a popular choice for VPN applications with remote roaming users since an L2TP client is built into the Microsoft Windows operating system. Since L2TP does not provide any encryption, it is usually combined with IPsec to provide data encryption.

This page includes these tabs:

- Server Setting (WAN)
- User Name Settings

## Server Setting (WAN)

### Menu Path: VPN > L2TP Server - Server Setting (WAN)

This page lets you enable and configure the L2TP server function of your device.

The screenshot shows the L2TP Server configuration interface. At the top, there's a title 'L2TP Server' and two tabs: 'Server Setting (WAN)' and 'User Name Settings'. The 'Server Setting (WAN)' tab is selected. Below the tabs, there are four input fields: 'L2TP Server Mode \*' with a dropdown menu showing 'Disabled'; 'Local IP' with a text input field containing '0.0.0.0'; 'Offered IP: Start' with a text input field containing '0.0.0.0'; and 'Offered IP: End' with a text input field containing '0.0.0.0'. At the bottom left, there is a green 'APPLY' button.

| UI Setting               | Description  | Valid Range        | Default Value |
|--------------------------|--|--------------------|---------------|
| <b>L2TP Server Mode</b>  | Enable or disable the L2TP server.   | Enabled / Disabled | Disabled      |
| <b>Local IP</b>          | Specify the IP address of the local subnet.                                    | Valid IP address   | 0.0.0.0       |
| <b>Offered IP: Start</b> | Specify the starting IP address of the offered IP range used for L2TP clients. | Valid IP address   | 0.0.0.0       |



| UI Setting             | Description  | Valid Range      | Default Value |
|------------------------|--|------------------|---------------|
| <b>Offered IP: End</b> | Specify the ending IP address of the offered IP range used for L2TP clients. | Valid IP address | 0.0.0.0       |

## User Name Settings

### Menu Path: VPN > L2TP Server - User Name Settings

This page lets you manage users that can connect to your device's L2TP server.

#### Limitations

You can add up to 10 users for the L2TP Server.

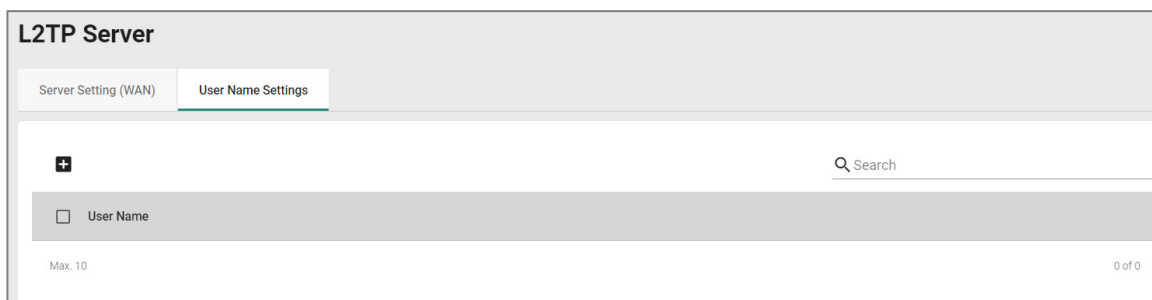

| UI Setting       | Description                         |
|------------------|-------------------------------------|
| <b>User Name</b> | Shows the name of the user account. |

### Delete Account for L2TP

#### Menu Path: VPN > L2TP Server - User Name Settings

You can delete an account by using the checkboxes to select the accounts you want to delete, then clicking the **Delete** (  ) icon.

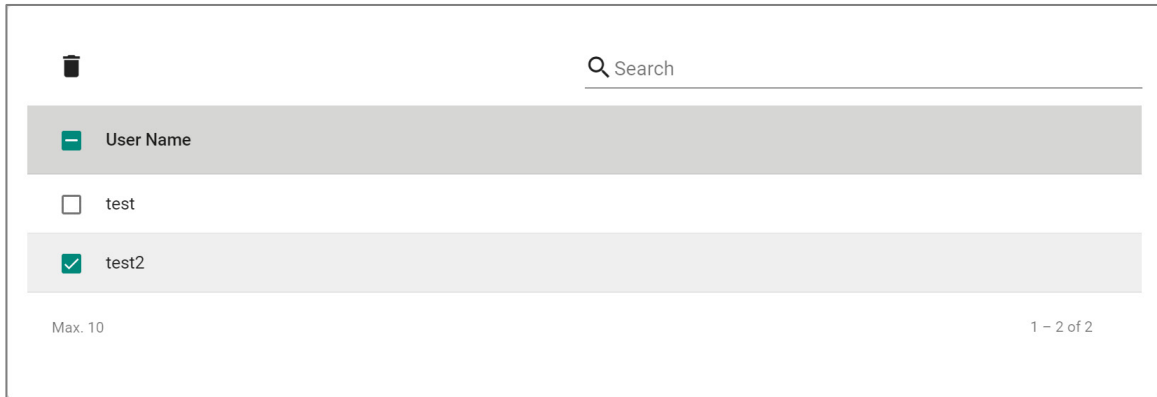

## Create New Account for L2TP

### Menu Path: VPN > L2TP Server - User Name Settings

Clicking the **Add** (➕) icon on the **VPN > L2TP Server - User Name Settings** page will open this dialog box. This dialog lets you create a new user account for the device's L2TP server. Click **CREATE** to save your changes and add the new account.

**Create New Account for L2TP**

Username \* 0 / 32

New Password \* 0 / 64

CANCEL CREATE

| UI Setting          | Description                            | Valid Range        | Default Value |
|---------------------|--|--------------------|---------------|
| <b>Username</b>     | Enter a username for the L2TP account. | 1 to 32 characters | N/A           |
| <b>New Password</b> | Enter a password for the L2TP account. | 1 to 64 characters | N/A           |

## OpenVPN Client

### Menu Path: VPN > OpenVPN Client

This page lets you manage the OpenVPN Client feature of your device.

**Note**

Availability of this feature may vary depending on your product model and version.

**Note**

For models with WAN redundancy, such as the EDR-G9004, running the OpenVPN client under WAN redundancy mode currently only supports failover, not failback. This means the device will not automatically switch back to the primary connection once it is restored.

This page includes these tabs:

- Settings
- Status

## OpenVPN Client - Settings

**Menu Path:** VPN > OpenVPN Client - Settings

This page lets you manage your OpenVPN Client settings.

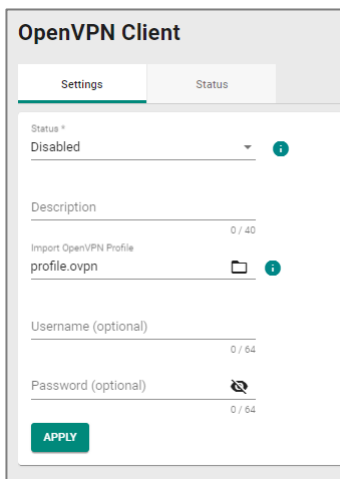

| UI Setting    | Description  | Valid Range        | Default Value |
|---------------|--|--------------------|---------------|
| <b>Status</b> | Enable or Disable OpenVPN Client.<br>IPsec and OpenVPN cannot be enabled simultaneously. | Enabled / Disabled | Disabled      |

| UI Setting                    | Description  | Valid Range        | Default Value |
|-------------------------------|--|--------------------|---------------|
| <b>Description</b>            | Specify the description for the OpenVPN Client connection.   | 0 to 40 characters | N/A           |
| <b>Import OpenVPN Profile</b> | Import the .ovpn file for OpenVPN Client setup. <div style="border: 1px solid #ccc; padding: 5px; margin-top: 10px;"> <p><b>Note</b></p> <p>Importing OpenVPN profiles is not supported in the CLI interface.</p> </div> | .ovpn files        | N/A           |
| <b>Username (optional)</b>    | Specify the username.  | 0 to 64 characters | N/A           |
| <b>Password (optional)</b>    | Specify the password.  | 0 to 64 characters | N/A           |

## OpenVPN Client - Status

**Menu Path:** VPN > OpenVPN Client - Status

This page lets you view the status of your OpenVPN Client connection.

| OpenVPN Client |             |                |                           |          |                      |                 |
|----------------|-------------|----------------|---------------------------|----------|----------------------|-----------------|
| Settings       |             | Status         |                           |          |                      |                 |
|                |             |                |                           |          |                      | Search          |
| Status         | Description | OpenVPN Server | OpenVPN Client IP Address | Duration | Data Received / Sent | Last Connection |
| Disconnected   | test        |                |                           | 0h:0m:0s | 0 Byte / 0 Byte      |                 |

| UI Setting                       | Description                               |
|----------------------------------|---|
| <b>Status</b>                    | Shows the status of the connection.       |
| <b>Description</b>               | Shows the description of the connection.  |
| <b>OpenVPN Server</b>            | Shows the OpenVPN Server IP Address.      |
| <b>OpenVPN Client IP Address</b> | Shows the OpenVPN Client IP Address.      |
| <b>Duration</b>                  | Shows the duration of OpenVPN connection. |

| UI Setting                  | Description   |
|-----------------------------|---|
| <b>Data Received / Sent</b> | Shows the number of bytes received/sent through the OpenVPN tunnel. |
| <b>Last Connection</b>      | Shows when the device was last connected to the OpenVPN server.     |

# Certificate Management

## Menu Path: Certificate Management

The Certificate Management settings area lets you manage X.509 digital certificates for your device. These certificates are commonly used for IPsec, OpenVPN, and HTTPS authentication. This device can act as a root CA (Certificate Authority) and issue a trusted root certificate. Alternatively, you can import certificates from other CAs.

Certificates are a time-based form of authentication. Before processing certificates, please ensure that your device is synced with the local device. For more information about syncing device time, please refer to [System > Time](#).

This section includes these pages:

- Local Certificate
- Trusted CA Certificate
- Certificate Signing Request

### ⚠ Warning

For security reasons, if the device is deployed without a CA server environment, we strongly recommend using short lifetime certificates (e.g., 24 hours) to ensure system security.

### ✍ Note

Because the device's default signature certificates are manufactured without third-party signatures, there is a potential risk of man-in-the-middle attacks that impersonate services, with the client-side being unable to verify.

Therefore, we recommend that upon activating the device, you use the Certificate Management > Local Certificate feature to add or update the certificate to one that belongs to your company and that is issued by a recognized certification authority in order to ensure the security and trustworthiness of your network communications.

## Certificate Management - User Privileges

Privileges to Certificate Management settings are granted to the different authority levels as follows. Refer to [System > Account Management > User Accounts](#) for more information on user accounts.

| Settings                    | Admin | Supervisor | User |
|-----------------------------|-------|------------|------|
| Local Certificate           | R/W   | -          | -    |
| Trusted CA Certificate      | R/W   | -          | -    |
| Certificate Signing Request | R/W   | -          | -    |

## Local Certificate

### Menu Path: Certificate Management > Local Certificate

This page lets you import and manage X.509 digital certificates.

#### Limitations

You can import up to 10 local certificates.

|  | Label   | Issued To | Issued By | Expiration Date | Key Length |
|---|---------|-----------|-----------|-----------------|------------|
| <input type="checkbox"/>  |         |           |           |                 |            |
|   | Max. 10 |           |           |                 | 0 of 0     |

| UI Setting             | Description                                   |
|------------------------|---|
| <b>Label</b>           | Shows the label identifying the certificate.  |
| <b>Issued To</b>       | Shows who the certificate was issued to.      |
| <b>Issued By</b>       | Shows who the certificate was issued by.      |
| <b>Expiration Date</b> | Shows the expiration date of the certificate. |
| <b>Key Length</b>      | Shows the key length of the certificate.      |

## Delete Certificate

Menu Path: Certificate Management > Local Certificate

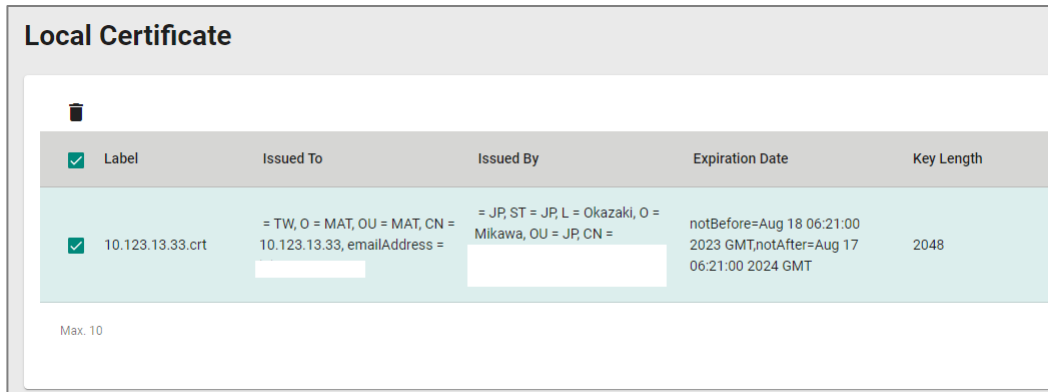

| <input checked="" type="checkbox"/> | Label            | Issued To   | Issued By  | Expiration Date  | Key Length |
|-------------------------------------|------------------|---|--|--|------------|
| <input checked="" type="checkbox"/> | 10.123.13.33.crt | = TW, O = MAT, OU = MAT, CN = 10.123.13.33, emailAddress = [redacted] | = JP, ST = JP, L = Okazaki, O = Mikawa, OU = JP, CN = [redacted] | notBefore=Aug 18 06:21:00 2023 GMT,notAfter=Aug 17 06:21:00 2024 GMT | 2048       |

Max. 10

You can delete certificates by using the checkboxes to select the certificates you want to delete, then clicking the **Delete (🗑)** icon.

### Note

You cannot delete a certificate if it is currently in use. If you would like to delete the item, you can go to SSL setting and change the certificate source to Auto Generate then unlock the certificate you'd like to change.

## Generate Certificate

Menu Path: Certificate Management > Local Certificate

Clicking the **Add (+)** icon on the **Certificate Management > Local Certificate** page will open this dialog box. This dialog lets you import a certificate from your local computer. Click **UPGRADE** to save your changes and add the new certificate.



| UI Setting  | Description  | Valid Range   | Default Value |
|---|--|---|---------------|
| <b>Import Identity Certificate</b>  | <p>Select the type of certificate to import.</p> <p><b>Certificate:</b> Used for certificates with a .crt file extension.</p> <p><b>Certificate From CSR:</b> Used for certificates issued by another CA.</p> <p><b>Certificate From PKCS#12:</b> Used for certificates with a .p12 file extension.</p> <div style="background-color: #f0f0f0; padding: 10px; margin-top: 10px;"> <p><b>Note</b></p> <p>Before importing a certificate issued by another CA, you should import its related trusted CA certificate first on the <a href="#">Certificate Management &gt; Trusted CA Certificate</a> page. Otherwise, your device may not recognize the certificate and reject the connection.</p> </div> | Certificate / Certificate From CSR / Certificate From PKCS#12 | N/A           |
| <b>Label</b>  | <p>Enter a label to help identify the certificate. If this is empty, the file name of the certificate will be used.</p>  | 1 to 30 characters  | N/A           |
| <b>CSR Common Name</b><br><b>(if Import Identity Certificate is Certificate From CSR)</b>     | <p>Select the CSR common name for the certificate.</p> <div style="background-color: #f0f0f0; padding: 10px; margin-top: 10px;"> <p><b>Note</b></p> <p>CSRs must be created in advance on the <a href="#">Certificate Management &gt; Certificate Signing Request - CSR Generate</a> page to select them here.</p> </div>  | Drop-down list of CSR names                                   | N/A           |
| <b>Import Password</b><br><b>(if Import Identity Certificate is Certificate From PKCS#12)</b> | <p>Enter the password for the certificate.</p>   | 0 to 32 characters  | N/A           |

| UI Setting                | Description  | Valid Range                      | Default Value |
|---------------------------|--|----------------------------------|---------------|
| <b>Select Certificate</b> | Click this field and select the certificate file from your computer. | Select a file from your computer | N/A           |

## Trusted CA Certificate

### Menu Path: Certificate Management > Trusted CA Certificate

This page lets you import and manage trusted CA certificates.

#### Limitations

You can import up to 10 trusted CA certificates.

|  |              |         |                 |            |
|--|--------------|---------|-----------------|------------|
| <input type="checkbox"/>   | Name         | Subject | Expiration Date | Key Length |
| <input type="checkbox"/>   | moxa (1).csr | 0       | ,               |            |
| Max. 10  |              |         |                 | 1 - 1 of 1 |

| UI Setting             | Description                                   |
|------------------------|---|
| <b>Name</b>            | Shows the name of the certificate file.       |
| <b>Subject</b>         | Shows the subject from the certificate.       |
| <b>Expiration Date</b> | Shows the expiration date of the certificate. |
| <b>Key Length</b>      | Shows the key length of the certificate.      |

## Delete CA Certificate

### Menu Path: Certificate Management > Trusted CA Certificate

You can delete certificates by using the checkboxes to select the certificates you want to delete, then clicking the **Delete** (  ) icon.

| <input checked="" type="checkbox"/> | Name         | Subject | Expiration Date | Key Length |
|-------------------------------------|--------------|---------|-----------------|------------|
| <input checked="" type="checkbox"/> | moxa (1).csr | 0       | ,               |            |

Max. 10 1 - 1 of 1

## Generate CA Certificate

### Menu Path: Certificate Management > Trusted CA Certificate

Clicking the **Add** (+) icon on the **Certificate Management > Trusted CA Certificate** page will open this dialog box. This dialog lets you import a CA certificate from your local computer. Click **UPGRADE** to save your changes and add the new certificate.

**Generate CA Certificate**

Select CA Certificate \*

| UI Setting                | Description  | Valid Range                      | Default Value |
|---------------------------|--|----------------------------------|---------------|
| <b>Select Certificate</b> | Click this field and select the certificate file from your computer. | Select a file from your computer | N/A           |

## Certificate Signing Request

### Menu Path: Certificate Management > Certificate Signing Request

This page lets you generate and manage key pairs and certificate signing requests (CSRs). Certificate signing requests are needed to apply for and import a digital identity certificate from a CA.

To get a certificate from a CA for connection purposes, you will need to:

1. Generate a key pair
2. Generate a CSR

This page includes these tabs:

- Key Pair Generate
- CSR Generate

## Key Pair Generate

**Menu Path: Certificate Management > Certificate Signing Request - Key Pair Generate**

This page lets you generate and manage key pairs, which are used to generate CSRs.

### Limitations

You can generate up to 10 key pairs.



| UI Setting           | Description                           |
|----------------------|---------------------------------------|
| <b>Name</b>          | Shows the name of the RSA key.        |
| <b>Key Pair Size</b> | Shows the size used for the key pair. |

### Delete RSA Key

**Menu Path: Certificate Management > Certificate Signing Request - Key Pair Generate**

You can delete key pairs by using the checkboxes to select the entries you want to delete, then clicking the **Delete (  )** icon.

|                                     |       | Q Search      |
|-------------------------------------|-------|---------------|
| <input type="checkbox"/>            | Name  | Key Pair Size |
| <input checked="" type="checkbox"/> | test1 | 1024          |
| <input type="checkbox"/>            | test2 | 2048          |

Max. 10 1 - 2 of 2

## Generate RSA Key

### Menu Path: Certificate Management > Certificate Signing Request - Key Pair Generate

Clicking the **Add (+)** icon on the **Certificate Management > Certificate Signing Request - Key Pair Generate** page will open this dialog box. This dialog lets you generate a new key pair to use when generating a CSR. Click **GENERATE** to save your changes and add the new key pair.

**Generate RSA Key**

Name \*  0 / 30

Key Pair Size \*

| UI Setting           | Description                      | Valid Range         | Default Value |
|----------------------|----------------------------------|---------------------|---------------|
| <b>Name</b>          | Specify a name for the RSA key.  | 1 to 30 characters  | N/A           |
| <b>Key Pair Size</b> | Select the key pair size to use. | 1024 Bit / 2048 Bit | N/A           |

## CSR Generate

### Menu Path: Certificate Management > Certificate Signing Request - CSR Generate

This page lets you generate and manage CSRs.

## 🔒 Limitations

You can generate up to 10 CSRs.

### Certificate Signing Request

Key Pair Generate   **CSR Generate**





| <input type="checkbox"/>                          | Name | Subject | Key Length |
|---|------|---------|------------|
| Max. 10 <span style="float: right;">0 of 0</span> |      |         |            |

| UI Setting        | Description                           |
|-------------------|---------------------------------------|
| <b>Name</b>       | Shows the name of the CSR.            |
| <b>Subject</b>    | Shows the subject of the CSR.         |
| <b>Key Length</b> | Shows the key length used by the CSR. |

## Delete Certificate Signing Request

### Menu Path: Certificate Management > Certificate Signing Request - CSR Generate

You can delete CSRs by using the checkboxes to select the entries you want to delete, then clicking the **Delete** (  ) icon.

 

| <input type="checkbox"/>            | Name   | Subject  | Key Length |
|-------------------------------------|--------|--|------------|
| <input checked="" type="checkbox"/> | 12.csr | C = 12, O = 12, OU = 12, CN = 12, emailAddress = 123@gmail.com | 1024       |

## Generate Certificate Signing Request

### Menu Path: Certificate Management > Certificate Signing Request - CSR Generate

Clicking the **Add (+)** icon on the **Certificate Management > Certificate Signing Request - CSR Generate** page will open this dialog box. This dialog lets you generate a new CSR. Click **CREATE** to save your changes and add the new CSR.

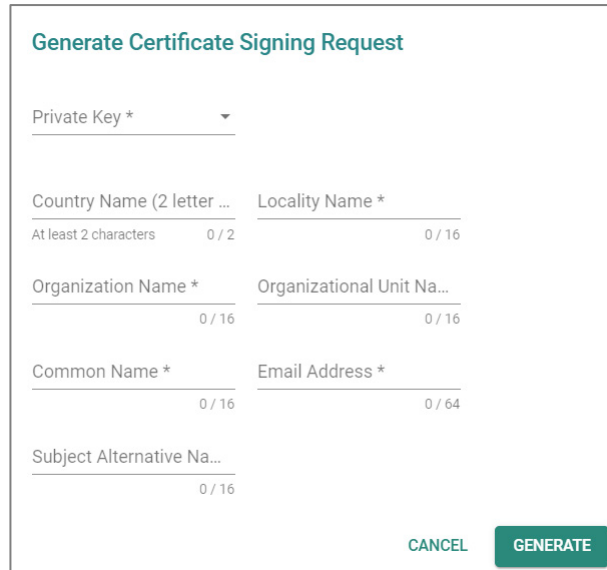

| UI Setting                          | Description  | Valid Range                 | Default Value |
|-------------------------------------|--|-----------------------------|---------------|
| <b>Private Key</b>                  | Select the key pair to use. To generate and manage key pairs, refer to <a href="#">Certificate Management &gt; Certificate Signing Request - Key Pair Generate</a> . | Drop-down list of key pairs | N/A           |
| <b>Country Name (2 letter code)</b> | Specify the 2-letter country code for the CSR.   | 2 characters                | N/A           |
| <b>Locality Name</b>                | Specify the locality name for the CSR.   | 1 to 16 characters          | N/A           |
| <b>Organization Name</b>            | Specify the organization name for the CSR.   | 1 to 16 characters          | N/A           |
| <b>Organization Unit Name</b>       | Specify the organization unit name for the CSR.  | 1 to 16 characters          | N/A           |
| <b>Common Name</b>                  | Specify the common name for the CSR.   | 1 to 16 characters          | N/A           |

| UI Setting                      | Description                                       | Valid Range        | Default Value |
|---------------------------------|---|--------------------|---------------|
| <b>Email Address</b>            | Specify the email address for the CSR.            | 1 to 64 characters | N/A           |
| <b>Subject Alternative Name</b> | Specify the subject alternative name for the CSR. | 1 to 16 characters | N/A           |

## Export Certificate Signing Request

**Menu Path: Certificate Management > Certificate Signing Request - CSR**

### Generate

You can export a CSR by using the checkboxes to select the entry you want to export, then clicking the **Export** (📄) icon.

#### **Note**

The export icon will only be available when a single entry is selected; it will not be available if multiple entries are selected.

|  Name | Subject  | Key Length |
|--|--|------------|
| <input checked="" type="checkbox"/> 12.csr   | C = 12, O = 12, OU = 12, CN = 12, emailAddress = 123@gmail.com | 1024       |



# Security

## Menu Path: Security

The Security settings area lets you configure security settings to help you secure your device and your network.

This settings area includes these sections:

- Device Security
- Network Security
- Authentication
- MXview Alert Notification

## Security - User Privileges

Privileges to Security settings are granted to the different authority levels as follows.

Refer to [System > Account Management > User Accounts](#) for more information on user accounts.

| Settings                    | Admin | Supervisor | User |
|-----------------------------|-------|------------|------|
| <b>Device Security</b>      |       |            |      |
| <b>Login Policy</b>         | R/W   | R          | R    |
| <b>Trusted Access</b>       | R/W   | R/W        | R    |
| <b>SSH &amp; SSL</b>        | R/W   | R/W        | -    |
| <b>Network Security</b>     |       |            |      |
| <b>IEEE 802.1X</b>          | R/W   | R/W        | R    |
| <b>Authentication</b>       |       |            |      |
| <b>Login Authentication</b> | R/W   | -          | -    |
| <b>RADIUS</b>               | R/W   | -          | -    |
| <b>TACACS+</b>              | R/W   | -          | -    |

| Settings                         | Admin | Supervisor | User |
|----------------------------------|-------|------------|------|
| <b>MXview Alert Notification</b> | R/W   | R/W        | R    |

## Device Security

### Menu Path: Security > Device Security

This section lets you configure security settings to protect your device.

This section includes these pages:

- Login Policy
- Trusted Access
- SSH & SSL

## Login Policy

### Menu Path: Security > Device Security > Login Policy

This page lets you configure the login policies for your device. Click **APPLY** to save your changes.

### Login Policy

Login Message

0 / 512

Login Authentication Failure Message

0 / 512

Login Failure Account Lockout

**Disabled** ▼

Login Failure Retry Threshold \*

**5**

1 - 10 times

Lockout Duration \*

**5**

1 - 10 min.

Auto Logout After \*

**5**

0 - 1440 min.

| UI Setting                                  | Description   | Valid Range         | Default Value |
|---|---|---------------------|---------------|
| <b>Login Message</b>                        | Specify the welcome message to display when users log in to the device.<br><br><div style="background-color: #fff9c4; padding: 5px;"> <p><b>⚠ Warning</b></p> <p>The Login Message should not include login-related information.</p> </div>   | 0 to 512 characters | N/A           |
| <b>Login Authentication Failure Message</b> | Specify the message to display if the user fails to log in.<br><br><div style="background-color: #fff9c4; padding: 5px;"> <p><b>⚠ Warning</b></p> <p>The Login Authentication Failure Message should not include information about passwords or other sensitive information.</p> </div> | 0 to 512 characters | N/A           |
| <b>Login Failure Account Lockout</b>        | Enable or disable the lockout function, which will temporarily prevent users from logging in for the <b>Lockout Duration</b> after the <b>Login Failure Retry Threshold</b> is exceeded. This can be useful for preventing brute force attacks.   | Enabled / Disabled  | Disabled      |
| <b>Login Failure Retry Threshold</b>        | Specify the number of login retry attempts before the user is locked out for the <b>Lockout Duration</b> .  | 1 to 10             | 5             |
| <b>Lockout Duration</b>                     | Specify the lockout duration (in minutes) during which a locked-out user will be unable to log in.  | 1 to 10             | 5             |
| <b>Auto Logout After</b>                    | Specify the amount of time a user can be idle before they will be automatically logged out from the device.   | 1 to 1440           | 5             |

## Trusted Access

### Menu Path: Security > Device Security > Trusted Access

This page lets you limit access to the device to trusted IP addresses you specify. You can also limit access to the device to LAN connections only.

#### 🔒 Limitations

You can create up to 10 trusted IP entries.

## Trusted Access Settings

### ⚠ Warning

Depending on the features you enable, you may lose access to your device if the computer you are using to configure the device is not in the Trusted IP List or connected through a LAN connection.

### ✍ Note

Trusted Access is restricted to the user interface, which includes the Web UI, CLI interface, and Moxa commands from software such as MXconfig and MXview.

Both the DNS Server and NTP Server are only accessible through LAN, VLAN, and Bridge interfaces. In other words, DNS clients and NTP clients cannot access the DNS or NTP service via WAN interfaces on the device.

Trusted IP List (Disabling this will allow all IP connections)

Disabled ▼

---

Accept All LAN Port Connections

Enabled ▼

---

Log Severity

Disabled ▼ Emergency ▼ Log Destination ▼

| UI Setting                             | Description   | Valid Range        | Default Value |
|--|---|--------------------|---------------|
| <b>Trusted IP List</b>                 | Enable or disable the Trusted IP List.<br><b>Enabled:</b> Only IP addresses in the Trusted IP List can access the device.<br><b>Disabled:</b> Any IP address can access the device.                                   | Enabled / Disabled | Disabled      |
| <b>Accept All LAN Port Connections</b> | Enable or disable accepting all connections from LAN connections.<br><b>Enabled:</b> The device can only be accessed through a LAN connection.<br><b>Disabled:</b> The device can be accessed through any connection. | Enabled / Disabled | Enabled       |
| <b>Log</b>                             | Enable or disable Trusted Access event logging.   | Enabled / Disabled | Disabled      |

| UI Setting             | Description   | Valid Range   | Default Value |
|------------------------|---|---|---------------|
| <b>Severity</b>        | Select the severity level to assign to Trusted Access events.<br><a href="#">Refer to the Severity Level List for more information about severity levels.</a>   | Emergency / Alert / Critical / Error / Warning / Notice / Informational / Debug | Emergency     |
| <b>Log Destination</b> | Specify where to send Trusted Access event logs. You can select multiple options.<br><b>Syslog:</b> Event logs will be sent to a syslog server.<br>Refer to <a href="#">Diagnostics &gt; Event Logs and Notifications &gt; Syslog</a> for more information.<br><b>Trap:</b> Event notifications will be sent to a trap server.<br>Refer to <a href="#">Diagnostics &gt; SNMP Trap/Inform</a> for more information.<br><b>Local Storage:</b> Event logs will be stored on local storage and will show up in the device's Event Log.<br>Refer to <a href="#">Diagnostics &gt; Event Logs and Notifications &gt; Event Log</a> for more information. | Syslog / Trap / Local Storage   | N/A           |

## Trusted IP List

| UI Setting    | Description  |
|---------------|--|
| <b>Index</b>  | Shows the index of the Trusted IP entry.                   |
| <b>Status</b> | Shows whether the Trusted IP entry is enabled or disabled. |

| UI Setting        | Description                                   |
|-------------------|---|
| <b>IP Address</b> | Shows the IP address of the Trusted IP entry. |
| <b>Netmask</b>    | Shows the netmask of the Trusted IP entry.    |

## Trusted Access - Create Index

### Menu Path: Security > Device Security > Trusted Access

Clicking the **Add (+)** icon on the **Security > Device Security > Trusted Access** page will open this dialog box. This dialog lets you add a trusted IP entry. Click **CREATE** to save your changes and add the new entry.

### Create Index 1

Status \*

IP Address \*

Netmask \*

| UI Setting        | Description                                    | Valid Range                | Default Value |
|-------------------|--|----------------------------|---------------|
| <b>Status</b>     | Enable or disable the Trusted IP entry.        | Enabled / Disabled         | Enabled       |
| <b>IP Address</b> | Specify the IP address of the trusted host(s). | Valid IP address           | N/A           |
| <b>Netmask</b>    | Select a netmask for the trusted host(s).      | Drop-down list of netmasks | N/A           |

## SSH & SSL

### Menu Path: Security > Device Security > SSH & SSL

This page lets you manage your SSH key and SSL certificate.

This page includes these tabs:

- SSH
- SSL

## SSH

**Menu Path:** [Security](#) > [Device Security](#) > [SSH & SSL - SSH](#)

This page lets you manage your device's SSH key.

This shows you when the current SSH key was created. Click **REGENERATE** to generate a new SSH key for your device.

### ⚠ Warning

Regenerating the SSH key will restart the device's system services and will make the device temporarily unavailable.

Created on  
Aug 10 07:23:59 2023 GMT  
.....

Regenerate SSH Key

**REGENERATE**

## SSL

**Menu Path:** [Security](#) > [Device Security](#) > [SSH & SSL - SSL](#)

This page lets you manage your device's SSL certificate. Click **APPLY** to save your changes.

## SSL Settings

Certificate Source \*

Local Certificate Database ▼

---

Certificate File

10.123.13.33.crt ▼

---

Created on

Aug 18 06:21:00 2023 GMT

.....

Expiration Date

Aug 17 06:21:00 2024 GMT

.....

APPLY

| UI Setting  | Description   | Valid Range  | Default Value |
|---|---|--|---------------|
| <b>Certificate Source</b>   | <p>Select the source for your device's SSL certificate.</p> <p><b>Auto Generate:</b> Your device will generate a certificate automatically.</p> <p><b>Local Certificate Database:</b> Your device will use an imported certificate from the Local Certificate database. You will only be able to select certificates from a CSR or PKCS#12 certificates.</p> <p>Refer to <a href="#">Certificate Management</a> for more information.</p> | Auto Generate / Local Certificate Database         | Auto Generate |
| <b>Certificate File (if Certificate Source is Local Certificate Database)</b> | Select the imported certificate file to use.  | Drop-down list of applicable imported certificates | N/A           |
| <b>Created on (View-only)</b>   | Shows when the current certificate was created.   | N/A  | N/A           |
| <b>Expiration Date (View-only)</b>  | Shows when the current certificate will expire.   | N/A  | N/A           |



# Network Security

**Menu Path:** [Security](#) > [Network Security](#)

This section lets you manage your device's network security features.

This section includes these pages:

- [IEEE 802.1X](#)

## IEEE 802.1X

**Menu Path:** [Security](#) > [Network Security](#) > [IEEE 802.1X](#)

This page lets you manage your device's IEEE 802.1X authentication feature.

This page includes these tabs:

- General
- IEEE 802.1X Status
- RADIUS
- Local Database

### **Note**

We recommend that users enable 802.1X as it provides enhanced network security and better access control.

## IEEE 802.1X - General

**Menu Path:** [Security](#) > [Network Security](#) > [IEEE 802.1X - General](#)

This page lets you configure your device's IEEE 802.1X settings.

## IEEE 802.1X Settings

Authentication Mode \*  
 Local Database ▼

---

Authentication Retry \*  
 Enabled ▼

---

Authentication Retry Interval \*  
 3600









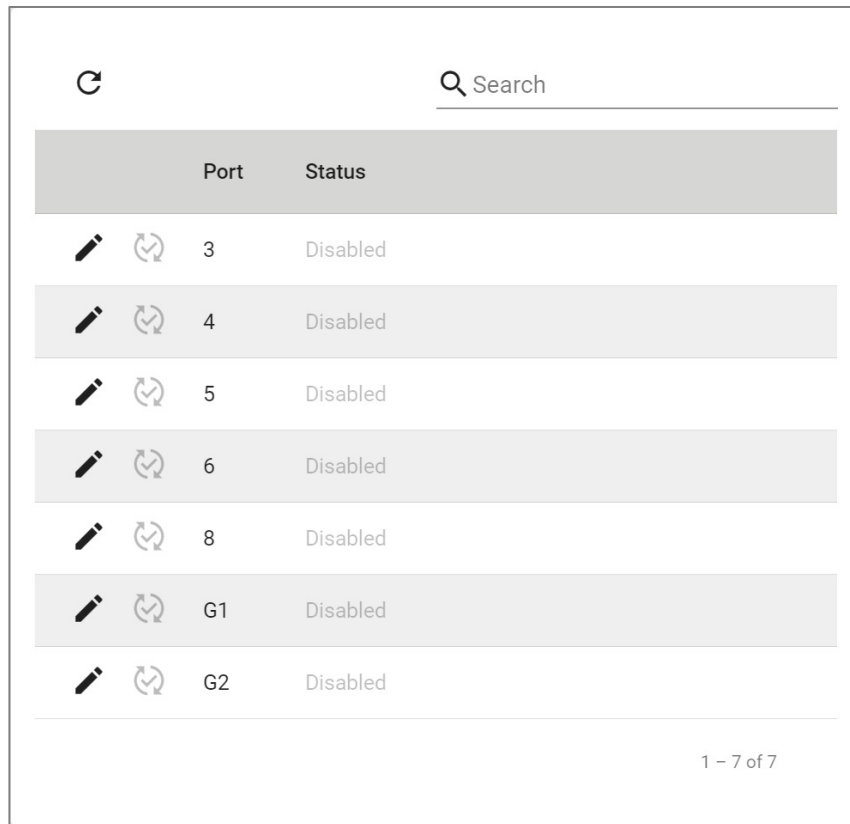





60 - 65535 sec.

**APPLY**

| UI Setting                           | Description   | Valid Range                             | Default Value  |
|--------------------------------------|---|---|----------------|
| <b>Authentication Mode</b>           | Select the method of authentication to use.<br><b>RADIUS:</b> Use a RADIUS server for authentication.<br><b>Local Database:</b> Use the local database for authentication.<br><b>RADIUS, Local:</b> Use both a RADIUS server and the local database for authentication. | RADIUS / Local Database / RADIUS, Local | Local Database |
| <b>Authentication Retry</b>          | Enable or disable reauthentication.   | Enabled / Disabled                      | Enabled        |
| <b>Authentication Retry Interval</b> | Specify the authentication retry interval in seconds.   | 60 to 65535                             | 3600           |

## IEEE 802.1X Port List



|   | Port | Status   |
|---|------|----------|
|     | 3    | Disabled |
|     | 4    | Disabled |
|     | 5    | Disabled |
|     | 6    | Disabled |
|     | 8    | Disabled |
|     | G1   | Disabled |
|   | G2   | Disabled |

1 - 7 of 7

| UI Setting    | Description  |
|---------------|--|
| <b>Port</b>   | Shows which port the entry is for.   |
| <b>Status</b> | Shows whether IEEE 802.1X port access control is enabled or disabled for the port. |

## IEEE 802.1X - Port Settings

**Menu Path:** [Security](#) > [Network Security](#) > [IEEE 802.1X - General](#)

Clicking the **Edit** (  ) icon for a port on the **Security > Network Security > IEEE 802.1X - General** page will open this dialog box. This dialog lets you edit a port's IEEE 802.1X settings. Click **APPLY** to save your changes.

### Port 3 Settings

Status \*  
Disabled ▼

CANCEL
APPLY

| UI Setting    | Description  | Valid Range        | Default Value |
|---------------|--|--------------------|---------------|
| <b>Status</b> | Enable or disable IEEE 802.1X port access control for this port. | Enabled / Disabled | Disabled      |

## IEEE 802.1X Status

**Menu Path:** [Security](#) > [Network Security](#) > [IEEE 802.1X - IEEE 802.1X Status](#)

This page lets you see the IEEE 802.1X status of your ports.

↻
🔍 Search

| Port   | Supplicant | User | Port Status |
|--|------------|------|-------------|
| Items per page: <span style="border-bottom: 1px solid #ccc; display: inline-block; width: 40px; vertical-align: middle;">50</span> ▼    0 of 0     < < > > |            |      |             |

| UI Setting        | Description  |
|-------------------|--|
| <b>Port</b>       | Shows which port the entry is for.                     |
| <b>Supplicant</b> | Shows the MAC address of the device requesting access. |
| <b>User</b>       | Shows the user's name.                                 |

| UI Setting         | Description  |
|--------------------|--|
| <b>Port Status</b> | <p>Shows the status of the 802.1X port.</p> <p><b>INITIALIZE:</b> The device is rebooting, the supplicant is sending an EAPoL start packet, or the port link is down.</p> <p><b>CONNECTING:</b> Communication is being established with a supplicant.</p> <p><b>DISCONNECTED:</b> This state is entered from the CONNECTING state, the AUTHENTICATED state, and the ABORTING state if an explicit logoff request is received from the supplicant, and from the CONNECTING state if the number of allowed reauthentication attempts has been exceeded.</p> <p><b>AUTHENTICATING:</b>The supplicant is being authenticated.</p> <p><b>AUTHENTICATED:</b> The supplicant was successfully authenticated.</p> <p><b>ABORTING:</b> The authentication procedure is being prematurely aborted due to receipt of a reauthentication request, an EAPoL-Start frame, an EAPoL-Logoff frame, or an authTimeout.</p> <p><b>HELD:</b> Authentication of the supplicant was unsuccessful.</p> |



## IEEE 802.1X - RADIUS

**Menu Path:** Security > Network Security > IEEE 802.1X - RADIUS

This page lets you specify a RADIUS server to use for IEEE 802.1X authentication. Click APPLY to save your changes.

### Note

The system will use the primary RADIUS server by default. If the primary RADIUS server is unavailable, it will use the secondary RADIUS server.

|  |  |
|--|--|
| Server Address 1   | Port                                   |
| <input type="text" value="0 / 64"/>  | <input type="text" value="1812"/>      |
| Shared Key  | <input type="text" value="1 - 65535"/> |
| <input type="text" value="0 / 64"/>  |  |
| Server Address 2   | Port                                   |
| <input type="text" value="0 / 64"/>  | <input type="text" value="1812"/>      |
| Shared Key  | <input type="text" value="1 - 65535"/> |
| <input type="text" value="0 / 64"/>  |  |
| <input type="button" value="APPLY"/>   |  |

| UI Setting              | Description  | Valid Range                     | Default Value |
|-------------------------|--|---------------------------------|---------------|
| <b>Server Address 1</b> | Specify the IP address or domain name for the primary RADIUS server.   | Valid IP address or domain name | N/A           |
| <b>UDP Port</b>         | Specify the port number for the primary RADIUS server.                 | 1 to 65535                      | 1812          |
| <b>Shared Key</b>       | Specify the shared key for the primary RADIUS server.                  | 0 to 60 characters              | N/A           |
| <b>Server Address 2</b> | Specify the IP address or domain name for the secondary RADIUS server. | Valid IP address or domain name | N/A           |
| <b>UDP Port</b>         | Specify the port number for the secondary RADIUS server.               | 1 to 65535                      | 1812          |
| <b>Shared Key</b>       | Specify the shared key for the secondary RADIUS server.                | 0 to 64 characters              | N/A           |

## Local Database

### Menu Path: Security > Network Security > IEEE 802.1X - Local Database

This page lets you create local database user accounts to use with IEEE 802.1X authentication.

+
Search

|                                   |
|-----------------------------------|
| <input type="checkbox"/> Username |
| <input type="checkbox"/> Test     |

Max. 32
1 - 1 of 1

| UI Setting      | Description                        |
|-----------------|------------------------------------|
| <b>Username</b> | Shows the username of the account. |

## Local Database - Create Account Settings

**Menu Path:** Security > Network Security > IEEE 802.1X - Local Database

Clicking the **Add (+)** icon on the **Security > Network Security > IEEE 802.1X - Local Database** page will open this dialog box. This dialog lets you create a new user account for IEEE 802.1X authentication. Click **APPLY** to save your changes and add the new account.

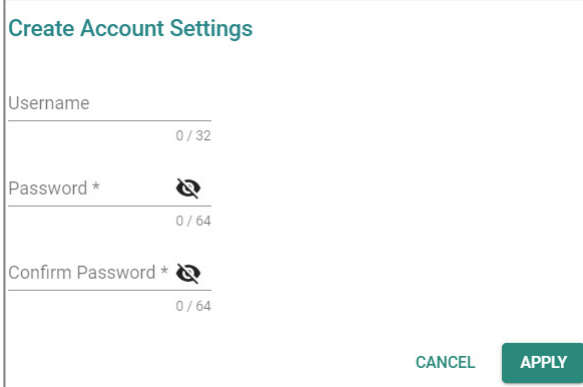

The dialog box titled "Create Account Settings" contains three input fields: "Username" with a character count of "0 / 32", "Password \*" with a character count of "0 / 64" and a visibility icon, and "Confirm Password \*" with a character count of "0 / 64" and a visibility icon. At the bottom right, there are two buttons: "CANCEL" and "APPLY".

| UI Setting      | Description                                  | Valid Range        | Default Value |
|-----------------|--|--------------------|---------------|
| <b>Username</b> | Specify the username for this account.       | 1 to 32 characters | N/A           |
| <b>Password</b> | Specify the password for this user account.  | 1 to 64 characters | N/A           |
| <b>Password</b> | Re-enter the password for this user account. | 1 to 64 characters | N/A           |

## Authentication

**Menu Path:** Security > Authentication

This section lets you manage login authentication for your device.

This section includes these pages:

- Login Authentication
- RADIUS
- TACACS+

# Login Authentication

**Menu Path:** Security > Authentication > Login Authentication

This page lets you configure your device's login authentication settings. Click **APPLY** to save your changes.

### Login Authentication

Authentication Protocol

Local

RADIUS

TACACS+

RADIUS, Local

TACACS+, Local

**APPLY**

| UI Setting                     | Description  | Valid Range   | Default Value |
|--------------------------------|--|---|---------------|
| <b>Authentication Protocol</b> | <p>Select the method of authentication to use.</p> <p><b>Local:</b> Use the local database for authentication.</p> <p><b>RADIUS:</b> Use a RADIUS server for authentication.</p> <p><b>TACACS+:</b> Use a TACACS+ Server for authentication.</p> <p><b>RADIUS, Local:</b> Use a RADIUS server for authentication first. If it fails, the device will use the local database for authentication.</p> <p><b>TACACS+, Local:</b> Use a TACACS+ server for authentication first. If it fails, the device will use the local database for authentication.</p> <div style="background-color: #fff9c4; padding: 10px; margin-top: 10px;"> <p><b>⚠ Warning</b></p> <p>If you configure the device to use a remote server such as RADIUS or TACACS+ but don't use a local database as a backup, you will be unable to log in through network services (HTTP/HTTPS/Telnet/SSH) if the device is unable to connect to the remote server for authentication. In such an event, the only way to access the device would be through the console port.</p> </div> | Local / RADIUS / TACACS+ / RADIUS, Local / TACACS+, Local | Local         |



# RADIUS

## Menu Path: Security > Authentication > RADIUS

This page lets you specify a RADIUS server to use for login authentication. Click APPLY to save your changes.

### Note

The system will use the primary RADIUS server by default. If the primary RADIUS server is unavailable, it will use the secondary RADIUS server.

Authentication Type \*  
EAP-PEAP MSCHAPv2 ▾

---

Server Address 1 UDP Port  
 1 - 65535  
0 / 63

Shared Key   
 0 / 64

---

Server Address 2 UDP Port  
 1 - 65535  
0 / 63

Shared Key   
 0 / 64

| UI Setting                 | Description  | Valid Range                     | Default Value     |
|----------------------------|--|---------------------------------|-------------------|
| <b>Authentication Type</b> | Select the authentication method to use for the RADIUS servers.      | PAP / CHAP / EAP-PEAP MSCHAPv2  | EAP-PEAP MSCHAPv2 |
| <b>Server Address 1</b>    | Specify the IP address or domain name for the primary RADIUS server. | Valid IP address or domain name | N/A               |
| <b>UDP Port</b>            | Specify the port number for the primary RADIUS server.               | 1 to 65535                      | 1812              |
| <b>Shared Key</b>          | Specify the shared key for the primary RADIUS server.                | 0 to 64 characters              | N/A               |

| UI Setting              | Description  | Valid Range                     | Default Value |
|-------------------------|--|---------------------------------|---------------|
| <b>Server Address 2</b> | Specify the IP address or domain name for the secondary RADIUS server. | Valid IP address or domain name | N/A           |
| <b>UDP Port</b>         | Specify the port number for the secondary RADIUS server.               | 1 to 65535                      | 1812          |
| <b>Shared Key</b>       | Specify the shared key for the secondary RADIUS server.                | 0 to 64 characters              | N/A           |

## TACACS+

### Menu Path: Security > Authentication > TACACS+

This page lets you set up TACACS+ protocol to authenticate remote users.

### TACACS+ Server

Server IP Address 1  
0.0.0.0

TCP Port \*  
49  
1 - 65535

Share Key 0 / 64

Auth Type \*  
CHAP

Timeout \*  
5  
5 - 180 sec.

Retry \*  
1  
0 - 5 times

Server IP Address 2  
0.0.0.0

TCP Port \*  
49  
1 - 65535

Share Key 0 / 64

Auth Type \*  
CHAP

Timeout \*  
5  
5 - 180 sec.

Retry \*  
1  
0 - 5 times

**APPLY**

| UI Setting                 | Description   | Valid Range        | Default Value |
|----------------------------|---|--------------------|---------------|
| <b>Server IP Address 1</b> | Specify the IPv4 address of the primary TACACS+ server to use. Setting the address to 0.0.0.0 will disable use of a primary TACACS+ server.<br><br>When authenticating a remote user, the device will try to authenticate them using the primary server specified by <b>Server IP Address 1</b> . If the device fails to connect to the primary server, it will try to authenticate by using the secondary server specified by <b>Server IP Address 2</b> . | Valid IP address   | 0.0.0.0       |
| <b>TCP Port</b>            | Specify the TCP port to use for authentication requests to the primary TACACS+ server.  | 1 to 65535         | 49            |
| <b>Shared Key</b>          | Specify the shared encryption key for the primary TACACS+ server.   | 1 to 64 characters | N/A           |
| <b>Auth Type</b>           | Specify which authentication type the primary TACACS+ server uses.  | PAP, CHAP, ASCII   | CHAP          |
| <b>Timeout</b>             | Specify the amount of time in seconds a client will wait for a response from the primary TACACS+ server before re-transmitting the request.   | 5 to 120 (sec)     | 5             |
| <b>Retry</b>               | Specify the number of times the device will try to contact the primary TACACS+ server.  | 0 to 5             | 1             |
| <b>Server IP Address2</b>  | Specify the IPv4 address of the secondary TACACS+ server to use. Setting the address to 0.0.0.0 will disable use of a secondary TACACS+ server.   | Valid IP address   | 0.0.0.0       |
| <b>TCP Port</b>            | Specify the TCP port to use for authentication requests to the secondary TACACS+ server.  | 1 to 65535         | 49            |
| <b>Shared Key</b>          | Specify the shared encryption key for the secondary TACACS+ server.   | 1 to 64 characters | N/A           |
| <b>Auth Type</b>           | Specify which authentication type the secondary TACACS+ server uses.  | PAP, CHAP, ASCII   | CHAP          |
| <b>Time out</b>            | Specify the amount of time in seconds a client will wait for a response from the secondary TACACS+ server before re-transmitting the request.   | 5 to 120 (sec)     | 5             |
| <b>Retry</b>               | Specify the number of times the device will try to contact the secondary TACACS+ server.  | 0 to 5             | 1             |

# MXview Alert Notification

**Menu Path:** Security > MXview Alert Notification

This page lets you configure device notifications for MXview.

This page includes these tabs:

- Security Notification Setting
- Security Status

## Security Notification Setting

**Menu Path:** Security > MXview Alert Notification - Security Notification Setting

This page lets you configure your MXview security alert notification settings.

**Note**

Notifications are handled by the SNMP Trap function, which should be configured in advance. Refer to Diagnostics > Event Logs and Notifications > SNMP Trap/Inform for more information.

In MXview, go to Preferences > Server > SNMP Trap Server and make sure the matching SNMP version is selected.





Firewall Event Notification \*  
Disabled

DoS Attack Event Notification \*  
Disabled

Access Violation Event Notificat...  
Disabled

Login Fail Event Notification \*  
Disabled

APPLY

| UI Setting                                 | Description   | Valid Range        | Default Value |
|--|---|--------------------|---------------|
| <b>Firewall Event Notification</b>         | <p>Enable or disable notifications for Firewall events.</p> <p> <b>Note</b></p> <p>After enabling this, you will need to enable logging and select <b>Trap</b> as the log destination for each firewall policy and feature you want notifications for.</p>   | Enabled / Disabled | Disabled      |
| <b>DoS Attack Event Notification</b>       | <p>Enable or disable notifications for DoS attack events.</p> <p> <b>Note</b></p> <p><a href="#">After enabling this, you will need to go to Firewall &gt; DoS Policy to enable logging and select Trap as the log destination to receive notifications.</a></p>   | Enabled / Disabled | Disabled      |
| <b>Access Violation Event Notification</b> | <p>Enable or disable notifications for Access Violation events.</p> <p> <b>Note</b></p> <p><a href="#">After enabling this, you will need to go to Security &gt; Device Security &gt; Trusted Access to enable logging and select Trap as the log destination to receive notifications.</a></p>                  | Enabled / Disabled | Disabled      |
| <b>Login Fail Event Notification</b>       | <p>Enable or disable notifications for Login Fail events.</p> <p> <b>Note</b></p> <p><a href="#">After enabling this, you will need to go to Diagnostics &gt; Event Logs and Notifications &gt; Event Notifications to enable logging and select Trap as the log destination to receive notifications.</a></p> | Enabled / Disabled | Disabled      |

## Security Status

### Menu Path: Security > MXview Alert Notification - Security Status

This page lets you see the status of all MXview security event types.

Clicking the **Reset** () icon will clear the status of all events to default (**safe**).

| Event            | Status |
|------------------|--------|
| Firewall         | safe   |
| DoS Attack       | safe   |
| Access Violation | safe   |
| Login Fail       | safe   |

Max. 10    Items per page: 50    1 - 4 of 4    << < > >>

| UI Setting    | Description  |
|---------------|--|
| <b>Event</b>  | Shows the name of the event type. Event types shown will vary depending on the device model.<br><br><div style="background-color: #f0f0f0; padding: 5px;"> <p> <b>Note</b><br/>The status of <b>Device Lockdown</b> can not be accessed in MXview One.</p> </div> |
| <b>Status</b> | Shows the current status of the event type.<br><b>safe:</b> No event of this type has been detected.<br><b>attacked:</b> An event of this type was detected.   |

# Diagnostics

## Menu Path: Diagnostics

The Diagnostics settings area lets you keep track of system and network performance, check event logs, and check the status of the port connectors.

This settings area includes these sections:

- System Status
- Network Status
- Event Logs and Notifications
- Tools

## Diagnostics - User Privileges

Privileges to Diagnostics settings are granted to the different authority levels as follows. Refer to [System > Account Management > User Accounts](#) for more information on user accounts.

| Settings                             | Admin | Supervisor | User |
|--------------------------------------|-------|------------|------|
| <b>System Status</b>                 |       |            |      |
| Utilization                          | R/W   | R/W        | R    |
| Fiber Check                          | R/W   | R/W        | R    |
| <b>Network Status</b>                |       |            |      |
| Network Statistics                   | R     | R          | R    |
| LLDP                                 | R/W   | R/W        | R    |
| ARP Table                            | R     | R          | R    |
| <b>Event Log &amp; Notifications</b> |       |            |      |
| Event Log                            | R/W   | R/W        | R    |
| Event Notifications                  | R/W   | R/W        | R    |

| Settings                  | Admin | Supervisor | User |
|---------------------------|-------|------------|------|
| <b>Syslog</b>             | R/W   | R          | R    |
| <b>SNMP Trap/Inform</b>   | R/W   | -          | -    |
| <b>Email Settings</b>     | R/W   | R          | R    |
| <b>SMS Settings</b>       | R/W   | R          | R    |
| <b>Tools</b>              |       |            |      |
| <b>Port Mirroring</b>     | R/W   | R/W        | R    |
| <b>Ping</b>               | R/W   | R/W        | R    |
| <b>Diagnostic Support</b> | R/W   | R/W        | R    |
| <b>NetFlow</b>            | R/W   | R/W        | R    |

## System Status

### Menu Path: [Diagnostics](#) > [System Status](#)

This section lets you check on various system statuses.

This section includes these pages:

- Utilization
- Fiber Check

## Utilization

### Menu Path: [Diagnostics](#) > [System Status](#) > [Utilization](#)

This page lets you monitor current and historical system resource utilization.

## CPU Usage

This shows the current CPU usage of your device.



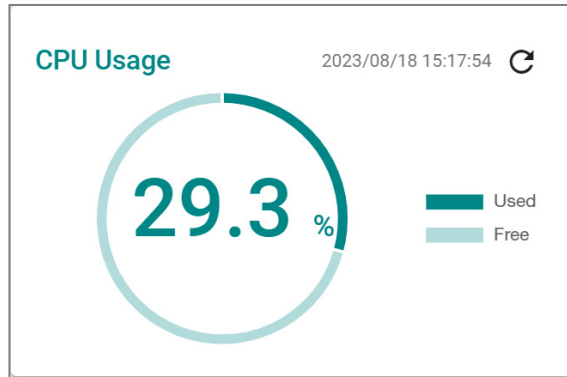

## CPU Usage History

This shows the CPU usage of your device over time.

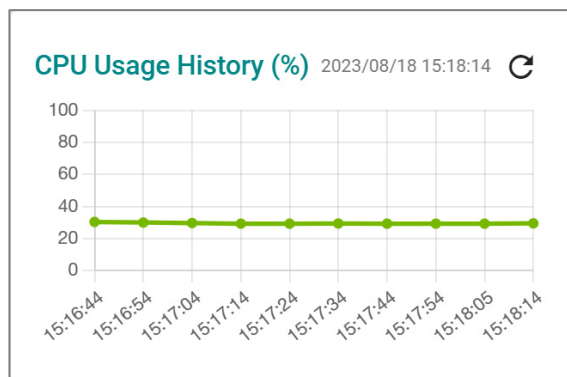

## Memory Usage

This shows your device's current memory usage.

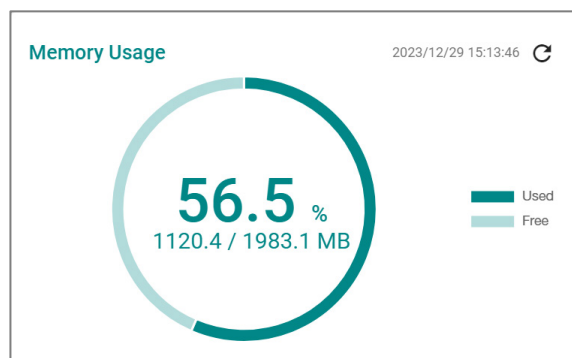

## Memory Usage History

This shows your device's memory usage over time.

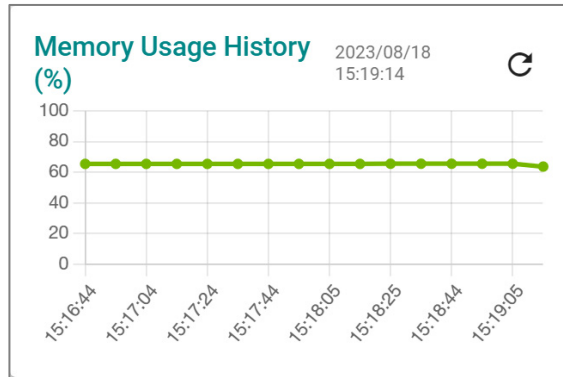

## Fiber Check

### Menu Path: [Diagnostics](#) > [System Status](#) > [Fiber Check](#)

This page lets you diagnose the link status of the device's fiber connectors, including SFP and fixed type (multi-mode SC/ST and single-mode SC) connectors. It lets you monitor the temperature, TX/RX power, and other parameters on fiber ports to determine if the ports are working properly.

You can enable trap, email warning, and/or relay warning functions to receive an alarm or relay if one of the fiber ports exceeds the threshold for that port. Refer to [Diagnostics > Event Logs and Notifications](#) for more information.

## Fiber Check Settings

**Fiber Check**

Fiber Check\*  
Enabled ↕

APPLY

---

↻ 🔍 Search

| Port | Model Name | Serial Number | Wavelength (nm) | Voltage (V) | Current Temperature (°C) | Temperature Threshold (°C) | Current TX Power (dBm) | Tx Power (Threshold Low/High) (dBm) | Current RX Power (dBm) | RX Power (Threshold Low/High) (dBm) |
|------|------------|---------------|-----------------|-------------|--------------------------|----------------------------|------------------------|-------------------------------------|------------------------|-------------------------------------|
| MG1  | SFP-1GZXLC | D530050009    | 1550            | 3.4         | 40.3                     | 100.0                      | 1.9                    | 5.0/0.0                             | 0.3                    | -1.0/-24.0                          |

1 - 1 of 1

| UI Setting         | Description                                | Valid Range        | Default Value |
|--------------------|--|--------------------|---------------|
| <b>Fiber Check</b> | Enable or disable the fiber check feature. | Enabled / Disabled | Disabled      |

## Fiber Check Status List

| Fiber Check  |            |               |                 |             |                          |                            |                        |                                     |                        |                                     |
|--|------------|---------------|-----------------|-------------|--------------------------|----------------------------|------------------------|-------------------------------------|------------------------|-------------------------------------|
| Fiber Check*   |            |               |                 |             |                          |                            |                        |                                     |                        |                                     |
| Enabled  |            |               |                 |             |                          |                            |                        |                                     |                        |                                     |
| <b>APPLY</b>   |            |               |                 |             |                          |                            |                        |                                     |                        |                                     |
| <div style="display: flex; justify-content: space-between;"> <span>↻</span> <span>🔍 Search</span> </div> |            |               |                 |             |                          |                            |                        |                                     |                        |                                     |
| Port   | Model Name | Serial Number | Wavelength (nm) | Voltage (V) | Current Temperature (°C) | Temperature Threshold (°C) | Current TX Power (dBm) | Tx Power (Threshold Low/High) (dBm) | Current RX Power (dBm) | RX Power (Threshold Low/High) (dBm) |
| MG1  | SFP-1GZXC  | D530050009    | 1550            | 3.4         | 40.3                     | 100.0                      | 1.9                    | 5.0/0.0                             | 0.3                    | -1.0/-24.0                          |
|  |            |               |                 |             |                          |                            |                        |                                     |                        | 1 - 1 of 1                          |

| UI Setting                                | Description   |
|---|---|
| <b>Port</b>                               | Shows the port number of the fiber connection.                            |
| <b>Model Name</b>                         | Shows the name of the related SFP module.                                 |
| <b>Serial Number</b>                      | Shows the serial number of the related SFP module.                        |
| <b>Wavelength (nm)</b>                    | Shows the wavelength of the fiber connection.                             |
| <b>Voltage (V)</b>                        | Shows the voltage supplied to the fiber connection.                       |
| <b>Current Temperature (°C)</b>           | Shows the current temperature of the fiber connection.                    |
| <b>Temperature Threshold (°C)</b>         | Shows the temperature threshold the fiber connection supports.            |
| <b>Current TX Power(dBm)</b>              | Shows the current transmit signal strength for the fiber connection.      |
| <b>TX Power (Threshold Low/High)(dBm)</b> | Shows the threshold of transmit signal strength for the fiber connection. |
| <b>Current RX Power(dBm)</b>              | Shows the current receive signal strength for the fiber connection.       |
| <b>RX Power (Threshold Low/High)(dBm)</b> | Shows the threshold of receive signal strength for the fiber connection.  |

# Network Status

## Menu Path: [Diagnostics](#) > [Network Status](#)

This section lets you check on the status of your device's network connections.

This section includes these pages:

- Network Statistics
- LLDP
- ARP Table

## Network Statistics

### Menu Path: [Diagnostics](#) > [Network Status](#) > [Network Statistics](#)

This page lets you see the real-time packet and bandwidth status for your device.

## Network Status Display

This display lets you switch between **Packet Counter** and **Bandwidth Utilization** views by clicking on the drop-down menu.

- **Packet Counter:** This view shows how many packets are being handled over time. This view updates every 5 seconds.
- **Bandwidth Utilization:** This view shows bandwidth utilization over time. This view updates every 3 seconds.

### **Note**

The default line shows activity for all IP interfaces for both Tx and Rx activity. You can add additional lines by clicking the Display Settings button.

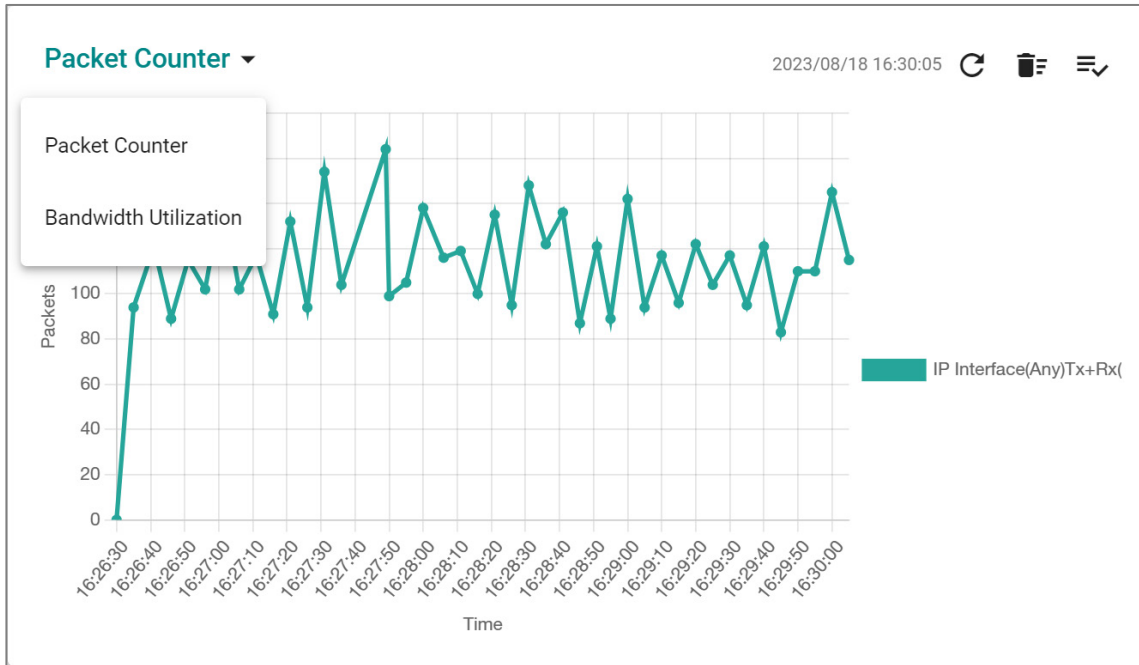

| UI Setting                         | Description   |
|------------------------------------|---|
| <b>Refresh</b> (↻)                 | Updates statistics immediately without waiting for the refresh interval.                      |
| <b>Reset Statistics Graph</b> (🗑️) | Clears the display and resets display settings back to defaults.                              |
| <b>Display Settings</b> (⚙️)       | Opens <b>Display Settings</b> , which allows you to add lines based on user-defined criteria. |

## Display Settings

### Menu Path: Diagnostics > Network Status > Network Statistics

Clicking the **Display Settings** (⚙️) icon on the **Diagnostics > Network Status > Network Statistics** page will open this dialog box. This dialog lets you define additional interfaces or ports to monitor. Click **ADD** to save your changes and add the new line.

### Display Settings

Display Type \*  
IP Interface ▼

Interface Selection \*  
Any ▼

Sniffer Mode \*  
Tx+Rx ▼

Package Type \*  
All Packets ▼

CANCEL
ADD

| UI Setting  | Description  | Valid Range                  | Default Value |
|---|--|------------------------------|---------------|
| <b>Display Type</b>   | Select whether to monitor an IP interface or a port.<br><b>Port:</b> Monitor traffic for a specific port.<br><b>IP Interface:</b> Monitor traffic for a specific network interface.  | Port / IP Interface          | IP Interface  |
| <b>Interface Selection</b><br>(if Display Type is IP Interface) | Select which interface to monitor.<br><br><div style="background-color: #f0f0f0; padding: 5px; margin-top: 10px;"> <p><b>Note</b></p> <p>Available interfaces will vary depending on your product model and configuration. Refer to <a href="#">Network Configuration &gt; Network Interfaces</a> for more information about managing your device's interfaces.</p> </div> | Drop-down list of interfaces | Any           |
| <b>Port Selection</b> (if Display Type is Port)                 | Select which port to monitor.<br><br><div style="background-color: #f0f0f0; padding: 5px; margin-top: 10px;"> <p><b>Note</b></p> <p>Available ports will vary depending on your product model.</p> </div>  | Drop-down list of ports      | All ports     |

| UI Setting  | Description   | Valid Range  | Default Value |
|---|---|--|---------------|
| <b>Sniffer Mode</b>   | Select which type of traffic to monitor.<br><b>Tx+Rx:</b> Monitor both transmit and receive traffic.<br><b>Tx:</b> Only monitor transmit traffic.<br><b>Rx:</b> Only monitor receive traffic.   | Tx+Rx / Tx / Rx  | Tx+Rx         |
| <b>Package Type</b>   | Select which packet type to monitor.<br><b>All Packets:</b> Monitor all packet types.<br><b>Unicast:</b> Only monitor unicast packets.<br><b>Broadcast:</b> Only monitor broadcast packets.<br><b>Multicast:</b> Only monitor multicast packets.<br><b>Error Packets:</b> Only monitor error packets. | All Packets / Unicast / Broadcast, Multicast / Error Packets | All Packets   |
| <p> <b>Note</b><br/>If <b>Display Type</b> is <b>IP Interface</b>, only <b>All Packets</b> and <b>Error Packets</b> will be available.</p> |   |  |               |

## Packet Interface Table

This table shows how many packets are being handled by each interface. Values are shown as *Total Packets + Packets in the past 5 seconds*.

**Packet Interface Table** 

🔍 Search

| Interface | Tx           | Tx Errors | Rx            | Rx Errors |
|-----------|--------------|-----------|---------------|-----------|
| WAN       | 2390832 + 45 | 0 + 0     | 7825083 + 246 | 0 + 0     |
| LAN       | 10 + 0       | 0 + 0     | 2 + 0         | 0 + 0     |
| lan_test  | 0 + 0        | 0 + 0     | 0 + 0         | 0 + 0     |
| BRG_LAN   | 0 + 0        | 0 + 0     | 0 + 0         | 0 + 0     |

1 - 4 of 4

# LLDP Settings

**Menu Path: Diagnostics > Network Status > LLDP**

This page lets you configure Link Layer Discovery Protocol (LLDP) settings.

## LLDP Settings

| UI Setting               | Description  | Valid Range        | Default Value |
|--------------------------|--|--------------------|---------------|
| <b>LLDP</b>              | Enable or disable Link Layer Discovery Protocol (LLDP).          | Enabled / Disabled | Enabled       |
| <b>Transmit Interval</b> | Specify the interval in seconds at which LLDP messages are sent. | 5 to 32768         | 30            |

| UI Setting                   | Description                             | Valid Range        | Default Value |
|------------------------------|---|--------------------|---------------|
| <b>LLDP Ring Port Bypass</b> | Enable or disable LLDP Ring Port Bypass | Enabled / Disabled | Disabled      |



## LLDP Status List

| Port | Nbr. ID           | Nbr. Port | Nbr. Port Description | Nbr. System         |
|------|-------------------|-----------|-----------------------|---------------------|
| 3    | 00:90:e8:00:00:04 | 1         | 100TX                 | NAT Router          |
| 8    | 88:3a:30:31:ce:03 | 162       | 4/3                   | TW-NTPC-OA-SW14A-01 |

| UI Setting                   | Description   |
|------------------------------|---|
| <b>Port</b>                  | Shows the number of the port that connects to the neighbor device.  |
| <b>Nbr. ID</b>               | Shows the unique ID (typically the MAC address) that identifies the neighbor device.                            |
| <b>Nbr. Port</b>             | Shows the port number of the connected neighbor device's interface that is used to connect to this device.      |
| <b>Nbr. Port Description</b> | Shows the port description of the connected neighbor device's interface that is used to connect to this device. |
| <b>Nbr. System</b>           | Shows the hostname of the neighbor device.  |

## ARP Table

### Menu Path: [Diagnostics](#) > [Network Status](#) > [ARP Table](#)

This page lets you see the device's Address Resolution Protocol (ARP) table.

## 🔔 Limitations

The ARP table can show up to 1024 entries.

| ARP Table |                   |             |           |
|-----------|-------------------|-------------|-----------|
| 🔄         |                   |             |           |
| 🔍 Search  |                   |             |           |
| Index     | MAC Address       | IP Address  | Interface |
| 1         | d0:67:26:a5:a3:f8 | 10.123.44.2 | WAN       |
| 2         | 00:00:02:00:00:00 | 10.123.44.1 | WAN       |
| 3         | 38:10:f0:d2:37:a0 | 10.123.44.3 | WAN       |

Max. 1024

Items per page: 50 1 - 3 of 3 |< < > >|

| UI Setting         | Description   |
|--------------------|---|
| <b>Index</b>       | Shows the index of the device entry.                  |
| <b>MAC Address</b> | Shows the MAC address of the device.                  |
| <b>IP Address</b>  | Shows the IP address used for the device.             |
| <b>Interface</b>   | Shows the interface the device is connecting through. |

## Event Logs and Notifications

### Menu Path: [Diagnostics](#) > [Event Logs and Notifications](#)

This section lets you set up and view your device's event logs and notifications.

This section includes these pages:

- Event Log
- Event Notifications
- Syslog
- SNMP Trap/Inform
- Email Settings
- SMS Settings

## Event Log

**Menu Path:** [Diagnostics > Event Logs and Notifications > Event Log](#)

This page lets you browse and export your device's various event logs to PDF, JSON, or Excel files.

### **Note**

Browser extensions such as ad-blockers, uBlock Origin may interfere with file exports. If you encounter this issue, we strongly recommend using a recommended browser and disabling any plug-ins. Refer to [Using a Web Browser to Configure the Industrial Secure Router](#) for more information.

This page includes these tabs:

- System Log
- Firewall Log
- VPN Log
- Settings and Backup

### **Note**

The timestamp on event logs will automatically synchronize with the NTP/SNTP server and applies to all new event logs. Refer to [System > Time > NTP/SNTP Server](#) for more details.

## System Log

**Menu Path:** [Diagnostics > Event Logs and Notifications > Event Log - System Log](#)

This page lets you view your device's system-related event logs.

### **Limitations**

The system log can record up to 1000 events.

## Actions

- Click the **Refresh icon** (🔄) to refresh the logs.
- Click the **Clear System Log icon** (🗑️) to delete all logs.
- Click the **Export icon** (📄) to export all logs to a file.

| Event Log  |                            |               |  |
|--|----------------------------|---------------|--|
| System Log   | Firewall Log               | VPN Log       | Settings and Backup  |
| 🔄 🗑️ 📄 <span style="float: right;">🔍 Search</span> |                            |               |  |
| Index  | Timestamp                  | Severity      | Additional message   |
| 1  | 2023/8/11<br>18:40:4+8:00  | Informational | Auth Ok, Login Success via Ui: Web. Account=admin, Bootup=71, Startup=2d3h41m38s             |
| 2  | 2023/8/11<br>18:26:7+8:00  | Informational | Logout via Ui: Web. Account=admin, Bootup=71, Startup=2d3h27m42s                             |
| 3  | 2023/8/11<br>17:43:57+8:00 | Informational | Auth Ok, Login Success via Ui: Web. Account=admin, Bootup=71, Startup=2d2h45m32s             |
| 4  | 2023/8/11<br>10:52:15+8:00 | Informational | Logout via Ui: Serial Console. Account=admin, Bootup=71, Startup=1d19h53m50s                 |
| 5  | 2023/8/11<br>10:45:13+8:00 | Informational | Auth Ok, Login Success via Ui: Serial Console. Account=admin, Bootup=71, Startup=1d19h46m48s |
| 6  | 2023/8/10<br>17:14:25+8:00 | Informational | Logout via Ui: Web. Account=admin, Bootup=71, Startup=1d2h15m59s                             |
| 7  | 2023/8/10<br>17:5:43+8:00  | Informational | Auth Ok, Login Success via Ui: Web. Account=admin, Bootup=71, Startup=1d2h7m18s              |

| UI Setting                | Description  |
|---------------------------|--|
| <b>Index</b>              | Shows the index of the event.  |
| <b>Timestamp</b>          | Shows the time of the event, including the date, time, and UTC time zone adjustment.   |
| <b>Severity</b>           | Shows the severity categorization of the event.  |
| <b>Additional message</b> | Shows additional information about the event, based on the type of event. The username of the account will also be recorded for the following events: <b>Login Success, Login Fail, Configuration Change, User Logout.</b> |

## Firewall Log

**Menu Path: [Diagnostics](#) > [Event Logs and Notifications](#) > [Event Log - Firewall Log](#)**

This page lets you view your device's firewall-related event logs.

## 🔔 Limitations

Each firewall log can record up to 1000 events.

You can switch between different firewall logs by clicking on the drop-down menu.

- Trusted Access
- Malformed Packets
- DoS Policy
- Layer 3-7 Policy
- Protocol Filter Policy
- ADP
- IPS
- Session Control
- Layer 2 Policy

## Actions

- Click the **Refresh icon** (🔄) to refresh the logs.
- Click the **Clear System Log icon** (🗑️) to delete all logs.
- Click the **Export icon** (📄) to export all logs to a file.

## Trusted Access

| Index | Timestamp | Severity | Ether Type | IP Protocol | Incoming Interface | Source MAC | Source IP | Source Port | Outgoing Interface | Destination IP | Destination Port | TCP Flags | ICMP Type | ICMP Code | Action | Additional message |
|-------|-----------|----------|------------|-------------|--------------------|------------|-----------|-------------|--------------------|----------------|------------------|-----------|-----------|-----------|--------|--------------------|
|-------|-----------|----------|------------|-------------|--------------------|------------|-----------|-------------|--------------------|----------------|------------------|-----------|-----------|-----------|--------|--------------------|

### UI Setting

### Description

#### Index

Shows the index of the event.

| UI Setting                | Description  |
|---------------------------|--|
| <b>Timestamp</b>          | Shows the time of the event, including the date, time, and UTC time zone adjustment.                                   |
| <b>Severity</b>           | Shows the severity categorization of the event: Refer to the <a href="#">Severity Level List</a> for more information. |
| <b>Ether Type</b>         | Shows the EtherType that applies to this event.  |
| <b>IP Protocol</b>        | Shows the IP protocol for this traffic.  |
| <b>Incoming Interface</b> | Shows the incoming interface for this traffic.   |
| <b>Source MAC</b>         | Shows the source MAC address for this traffic.   |
| <b>Source IP</b>          | Shows the source IP address for this traffic.  |
| <b>Source Port</b>        | Shows the source port for this traffic.  |
| <b>Outgoing Interface</b> | Shows the destination interface for this traffic.  |
| <b>Destination IP</b>     | Shows the destination IP address for this traffic.   |
| <b>Destination Port</b>   | Shows the destination port for this traffic.   |
| <b>TCP Flags</b>          | Shows the TCP flags that apply to this event.  |
| <b>ICMP Type</b>          | Shows the ICMP type that applies to this event.  |
| <b>ICMP Code</b>          | Shows the ICMP code that applies to this event.  |
| <b>Action</b>             | Shows the action taken by the firewall for this event.   |
| <b>Additional message</b> | Shows additional information about the event, based on the type of event.  |

## Malformed Packets

Malformed Packets ▾

🔄 🗑️ 📄 🔍 Search

| Index | Timestamp               | Severity  | Ether Type | IP Protocol | Incoming Interface | Source MAC        | Source IP     | Source Port | Outgoing Interface | Destination IP | Destination Port | TCP Flags     | ICMP Type | ICMP Code | Action | Additional message |
|-------|-------------------------|-----------|------------|-------------|--------------------|-------------------|---------------|-------------|--------------------|----------------|------------------|---------------|-----------|-----------|--------|--------------------|
| 1     | 2023/3/10 11:34:27+8:00 | Emergency | 2048       | TCP         | WAN                | d0:67:26:a5:a3:f8 | 3.129.140.152 | 8883        | --                 | 10.123.13.33   | 46340            | RST, ACK, URG | --        | --        | DROP   |                    |
| 2     | 2023/3/10 11:34:24+8:00 | Emergency | 2048       | TCP         | WAN                | 38:10:f0:d2:37:a0 | 3.129.140.152 | 8883        | --                 | 10.123.13.33   | 46338            | RST, ACK, URG | --        | --        | DROP   |                    |
| 3     | 2023/3/10 11:34:22+8:00 | Emergency | 2048       | TCP         | WAN                | d0:67:26:a5:a3:f8 | 10.160.127.71 | 47833       | --                 | 10.123.13.33   | 80               | RST, ACK, URG | --        | --        | DROP   |                    |

| UI Setting                | Description  |
|---------------------------|--|
| <b>Index</b>              | Shows the index of the event.  |
| <b>Timestamp</b>          | Shows the time of the event, including the date, time, and UTC time zone adjustment.                                   |
| <b>Severity</b>           | Shows the severity categorization of the event: Refer to the <a href="#">Severity Level List</a> for more information. |
| <b>Ether Type</b>         | Shows the EtherType that applies to this event.  |
| <b>IP Protocol</b>        | Shows the IP protocol for this traffic.  |
| <b>Incoming Interface</b> | Shows the incoming interface for this traffic.   |
| <b>Source MAC</b>         | Shows the source MAC address for this traffic.   |
| <b>Source IP</b>          | Shows the source IP address for this traffic.  |
| <b>Source Port</b>        | Shows the source port for this traffic.  |
| <b>Outgoing Interface</b> | Shows the destination interface for this traffic.  |
| <b>Destination IP</b>     | Shows the destination IP address for this traffic.   |
| <b>Destination Port</b>   | Shows the destination port for this traffic.   |
| <b>TCP Flags</b>          | Shows the TCP flags that apply to this event.  |
| <b>ICMP Type</b>          | Shows the ICMP type that applies to this event.  |
| <b>ICMP Code</b>          | Shows the ICMP code that applies to this event.  |

| UI Setting                | Description   |
|---------------------------|---|
| <b>Action</b>             | Shows the action taken by the firewall for this event: <ul style="list-style-type: none"> <li>• Accept</li> <li>• Drop</li> </ul> |
| <b>Additional message</b> | Shows additional information about the event, based on the type of event.   |

## DoS Policy

The screenshot shows a web interface for 'DoS Policy'. At the top, there is a search bar and a refresh icon. Below is a table with the following columns: Index, Timestamp, Severity, Ether Type, Subcategory, IP Protocol, Incoming Interface, Source MAC, Source IP, Source Port, Outgoing Interface, Destination IP, Destination Port, TCP Flags, ICMP Type, ICMP Code, Action, and Additional message. The table is currently empty, and the page indicates 'Max. 1000' items and 'Items per page: 50'.

| UI Setting         | Description   |
|--------------------|---|
| <b>Index</b>       | Shows the index of the event.   |
| <b>Timestamp</b>   | Shows the time of the event, including the date, time, and UTC time zone adjustment.  |
| <b>Severity</b>    | Shows the severity categorization of the event: Refer to the <a href="#">Severity Level List</a> for more information.  |
| <b>Ether Type</b>  | Shows the EtherType that applies to this event.   |
| <b>Subcategory</b> | Shows the subcategory that applies to this event: <ul style="list-style-type: none"> <li>• Null Scan</li> <li>• Xmas Scan</li> <li>• NMAP-Xmas Scan</li> <li>• SYN/FIN Scan</li> <li>• FIN Scan</li> <li>• NMAP-ID Scan</li> <li>• SYN/RST Scan</li> <li>• NEW-TCP-Without-SYN Scan</li> <li>• ICMP-Death</li> <li>• SYN-Flood</li> <li>• ARP-Flood</li> <li>• UDP-Flood</li> </ul> |



| UI Setting                | Description   |
|---------------------------|---|
| <b>IP Protocol</b>        | Shows the IP protocol for this traffic.                                   |
| <b>Incoming Interface</b> | Shows the incoming interface for this traffic.                            |
| <b>Source MAC</b>         | Shows the source MAC address for this traffic.                            |
| <b>Source IP</b>          | Shows the source IP address for this traffic.                             |
| <b>Source Port</b>        | Shows the source port for this traffic.                                   |
| <b>Outgoing Interface</b> | Shows the destination interface for this traffic.                         |
| <b>Destination IP</b>     | Shows the destination IP address for this traffic.                        |
| <b>Destination Port</b>   | Shows the destination port for this traffic.                              |
| <b>TCP Flags</b>          | Shows the TCP flags that apply to this event.                             |
| <b>ICMP Type</b>          | Shows the ICMP type that applies to this event.                           |
| <b>ICMP Code</b>          | Shows the ICMP code that applies to this event.                           |
| <b>Action</b>             | Shows the action taken by the firewall for this event.                    |
| <b>Additional message</b> | Shows additional information about the event, based on the type of event. |

## Layer 3-7 Policy

Layer 3-7 Policy ▾

🔄
🗑️
📄
🔍 Search

| Index              | Timestamp | Severity | Policy ID | Policy Name | Ether Type | IP Protocol | Incoming Interface | Source MAC | Source IP | Source Port | Outgoing Interface | Destination IP | Destination Port | TCP Flags | ICMP Type | ICMP Code | Action |
|--------------------|-----------|----------|-----------|-------------|------------|-------------|--------------------|------------|-----------|-------------|--------------------|----------------|------------------|-----------|-----------|-----------|--------|
| Max. 1000          |           |          |           |             |            |             |                    |            |           |             |                    |                |                  |           |           |           |        |
| Items per page: 50 |           |          |           |             |            |             |                    |            |           |             |                    |                |                  | 0 of 0    |           |           |        |

⏪
⏩
⏴
⏵

| UI Setting       | Description  |
|------------------|--|
| <b>Index</b>     | Shows the index of the event.  |
| <b>Timestamp</b> | Shows the time of the event, including the date, time, and UTC time zone adjustment. |

| UI Setting                | Description  |
|---------------------------|--|
| <b>Severity</b>           | Shows the severity categorization of the event: Refer to the <a href="#">Severity Level List</a> for more information.           |
| <b>Policy ID</b>          | Shows the ID of the firewall policy that applies to this event.  |
| <b>Policy Name</b>        | Shows the name of the firewall policy that applies to this event.  |
| <b>Ether Type</b>         | Shows the EtherType that applies to this event.  |
| <b>IP Protocol</b>        | Shows the IP protocol for this traffic.  |
| <b>Incoming Interface</b> | Shows the incoming interface for this traffic.   |
| <b>Source MAC</b>         | Shows the source MAC address for this traffic.   |
| <b>Source IP</b>          | Shows the source IP address for this traffic.  |
| <b>Source Port</b>        | Shows the source port for this traffic.  |
| <b>Outgoing Interface</b> | Shows the destination interface for this traffic.  |
| <b>Destination IP</b>     | Shows the destination IP address for this traffic.   |
| <b>Destination Port</b>   | Shows the destination port for this traffic.   |
| <b>TCP Flags</b>          | Shows the TCP flags that apply to this event.  |
| <b>ICMP Type</b>          | Shows the ICMP type that applies to this event.  |
| <b>ICMP Code</b>          | Shows the ICMP code that applies to this event.  |
| <b>Action</b>             | Shows the action taken by the firewall for this event: <ul style="list-style-type: none"> <li>• Allow</li> <li>• Deny</li> </ul> |

## Protocol Filter Policy

Protocol Filter Policy

Max. 1000

Items per page: 50 0 of 0

| UI Setting                  | Description  |
|-----------------------------|--|
| <b>Index</b>                | Shows the index of the event.  |
| <b>Timestamp</b>            | Shows the time of the event, including the date, time, and UTC time zone adjustment.                                   |
| <b>Severity</b>             | Shows the severity categorization of the event: Refer to the <a href="#">Severity Level List</a> for more information. |
| <b>Application Protocol</b> | Shows which application this event is related to.  |
| <b>Policy ID</b>            | Shows the ID of the firewall policy that applies to this event.  |
| <b>Policy Name</b>          | Shows the name of the firewall policy that applies to this event.  |
| <b>Ether Type</b>           | Shows the EtherTypes for this traffic.   |
| <b>IP Protocol</b>          | Shows the IP protocol for this traffic.  |
| <b>Incoming Interface</b>   | Shows the incoming interface for this traffic.   |
| <b>Source MAC</b>           | Shows the source MAC address for this traffic.   |
| <b>Source IP</b>            | Shows the source IP address for this traffic.  |
| <b>Source Port</b>          | Shows the source port for this traffic.  |
| <b>Outgoing Interface</b>   | Shows the destination interface for this traffic.  |
| <b>Destination IP</b>       | Shows the destination IP address for this traffic.   |
| <b>Destination Port</b>     | Shows the destination port for this traffic.   |
| <b>TCP Flags</b>            | Shows the TCP flags for this traffic.  |

| UI Setting       | Description  |
|------------------|--|
| <b>ICMP Type</b> | Shows the ICMP type that applies to this event.        |
| <b>ICMP Code</b> | Shows the ICMP code that applies to this event.        |
| <b>Action</b>    | Shows the action taken by the firewall for this event. |

## ADP

| Index | Timestamp              | Application Protocol | Policy ID | Policy Name                   | Ether Type | IP Protocol | Incoming Interface | Source IP       | Source Port | Outgoing Interface | Destination IP | Destination Port | Action  |
|-------|------------------------|----------------------|-----------|-------------------------------|------------|-------------|--------------------|-----------------|-------------|--------------------|----------------|------------------|---------|
| 1     | 2022/10/6 16:0:19+8:00 | IEC-104              | 1000002   | The magic number is not 0x68. | 2048       | TCP         | LAN                | 192.168.127.200 | 443         | WAN                | 10.123.34.120  | 2404             | Monitor |
| 2     | 2022/10/6 16:0:19+8:00 | IEC-104              | 1000002   | The magic number is not 0x68. | 2048       | TCP         | LAN                | 192.168.127.200 | 443         | WAN                | 10.123.34.120  | 2404             | Monitor |

| UI Setting                  | Description  |
|-----------------------------|--|
| <b>Index</b>                | Shows the index of the event.  |
| <b>Timestamp</b>            | Shows the time of the event, including the date, time, and UTC time zone adjustment. |
| <b>Application Protocol</b> | Shows the application protocol that applies to this event.                           |
| <b>Policy ID</b>            | Shows the ID of the firewall policy that applies to this event.                      |
| <b>Policy Name</b>          | Shows the name of the firewall policy that applies to this event.                    |
| <b>Ether Type</b>           | Shows the EtherType that applies to this event.                                      |
| <b>Subcategory</b>          | Shows the subcategory that applies to this event.                                    |
| <b>IP Protocol</b>          | Shows the IP protocol for this traffic.  |
| <b>Incoming Interface</b>   | Shows the incoming interface for this traffic.                                       |
| <b>Source IP</b>            | Shows the source IP address for this traffic.  |
| <b>Source Port</b>          | Shows the source port for this traffic.  |

| UI Setting                | Description  |
|---------------------------|--|
| <b>Outgoing Interface</b> | Shows the destination interface for this traffic.  |
| <b>Destination IP</b>     | Shows the destination IP address for this traffic.   |
| <b>Destination Port</b>   | Shows the destination port for this traffic.   |
| <b>Action</b>             | Shows the action taken by the firewall for this event: <ul style="list-style-type: none"> <li>• <b>Accept:</b> The traffic will be allowed to pass through.</li> <li>• <b>Reset:</b> The traffic will not be allowed to pass through.</li> <li>• <b>Monitor:</b> The traffic will be allowed to pass through, but a log entry will be created for it.</li> </ul> |

## IPS

| Index | Timestamp                 | IPS Severity | IPS Category | Policy ID | Policy Name  | Ether Type | IP Protocol | Incoming Interface | Source MAC        | Source IP   | Source Port | Outgoing Interface | Destination IP  | Destination Port | TCP Flags | Action |
|-------|---------------------------|--------------|--------------|-----------|--|------------|-------------|--------------------|-------------------|-------------|-------------|--------------------|-----------------|------------------|-----------|--------|
| 1     | 2023/3/10<br>9:13:12+8:00 | High         | Exploits     | 1139266   | DHCP ISC DHCP<br>dhclient Network<br>Configuration<br>Script Command<br>Injection -2 (CVE-<br>2011-0997) | 2048       | UDP         | WAN                | d0:67:26:a5:a3:f8 | 10.124.0.33 | 67          | --                 | 255.255.255.255 | 68               | --        | Reset  |

| UI Setting          | Description   |
|---------------------|---|
| <b>Index</b>        | Shows the index of the event.   |
| <b>Timestamp</b>    | Shows the time of the event, including the date, time, and UTC time zone adjustment.  |
| <b>IPS Severity</b> | Shows the IPS severity of the event: <ul style="list-style-type: none"> <li>• Information</li> <li>• Low</li> <li>• Medium</li> <li>• High</li> <li>• Critical</li> </ul> |

| UI Setting                | Description   |
|---------------------------|---|
| <b>IPS Category</b>       | Shows the IPS category of the event: <ul style="list-style-type: none"> <li>• File vulnerabilities</li> <li>• Buffer overflow</li> <li>• DoS attacks</li> <li>• Exploits</li> <li>• Malware traffic</li> <li>• Reconnaissance</li> <li>• Web threats</li> <li>• Flooding &amp; scan</li> <li>• Protocol attack protection</li> <li>• IP spoofing</li> </ul> |
| <b>Policy ID</b>          | Shows the ID of the firewall policy that applies to this event.   |
| <b>Policy Name</b>        | Shows the name of the firewall policy that applies to this event.   |
| <b>Ether Type</b>         | Shows the EtherType that applies to this event.   |
| <b>IP Protocol</b>        | Shows the IP protocol for this traffic.   |
| <b>Incoming Interface</b> | Shows the incoming interface for this traffic.  |
| <b>Source MAC</b>         | Shows the source MAC address for this traffic.  |
| <b>Source IP</b>          | Shows the source IP address for this traffic.   |
| <b>Source Port</b>        | Shows the source port for this traffic.   |
| <b>Outgoing Interface</b> | Shows the destination interface for this traffic.   |
| <b>Destination IP</b>     | Shows the destination IP address for this traffic.  |
| <b>Destination Port</b>   | Shows the destination port for this traffic.  |
| <b>TCP Flags</b>          | Shows the TCP flags that apply to this event.   |
| <b>Action</b>             | Shows the action taken by the firewall for this event.  |

## Session Control

| Index | Timestamp | Severity | Policy ID | Policy Name | Ether Type | IP Protocol | Incoming Interface | Source MAC | Source IP | Source Port | Outgoing Interface | Destination IP | Destination Port | TCP Flags | ICMP Type | ICMP Code | Action |
|-------|-----------|----------|-----------|-------------|------------|-------------|--------------------|------------|-----------|-------------|--------------------|----------------|------------------|-----------|-----------|-----------|--------|
|-------|-----------|----------|-----------|-------------|------------|-------------|--------------------|------------|-----------|-------------|--------------------|----------------|------------------|-----------|-----------|-----------|--------|

Max. 1000



Items per page: 50 0 of 0 |< < > >|

| UI Setting                | Description  |
|---------------------------|--|
| <b>Index</b>              | Shows the index of the event.  |
| <b>Timestamp</b>          | Shows the time of the event, including the date, time, and UTC time zone adjustment.                                   |
| <b>Severity</b>           | Shows the severity categorization of the event: Refer to the <a href="#">Severity Level List</a> for more information. |
| <b>Policy ID</b>          | Shows the ID of the firewall policy that applies to this event.  |
| <b>Policy Name</b>        | Shows the name of the firewall policy that applies to this event.  |
| <b>Ether Type</b>         | Shows the EtherType that applies to this event.  |
| <b>IP Protocol</b>        | Shows the IP protocol for this traffic.  |
| <b>Incoming Interface</b> | Shows the incoming interface for this traffic.   |
| <b>Source MAC</b>         | Shows the source MAC address for this traffic.   |
| <b>Source IP</b>          | Shows the source IP address for this traffic.  |
| <b>Source Port</b>        | Shows the source port for this traffic.  |
| <b>Outgoing Interface</b> | Shows the destination interface for this traffic.  |
| <b>Destination IP</b>     | Shows the destination IP address for this traffic.   |
| <b>Destination Port</b>   | Shows the destination port for this traffic.   |
| <b>TCP Flags</b>          | Shows the TCP flags that apply to this event.  |
| <b>ICMP Type</b>          | Shows the ICMP type that applies to this event.  |
| <b>ICMP Code</b>          | Shows the ICMP code that applies to this event.  |

| UI Setting    | Description  |
|---------------|--|
| <b>Action</b> | Shows the action taken by the firewall for this event. |

## Layer 2 Policy

Layer 2 Policy ▾



Q Search

| Index   | Timestamp | Severity | Ether Type | Source MAC | Destination MAC | Action |
|---|-----------|----------|------------|------------|-----------------|--------|
| Max. 1000 <span style="margin-left: 100px;">Items per page: 50 ▾</span> <span style="margin-left: 20px;">0 of 0</span> <span style="float: right;"> &lt; &lt; &gt; &gt; </span> |           |          |            |            |                 |        |

| UI Setting             | Description  |
|------------------------|--|
| <b>Index</b>           | Shows the index of the event.  |
| <b>Timestamp</b>       | Shows the time of the event, including the date, time, and UTC time zone adjustment.   |
| <b>Severity</b>        | Shows the severity categorization of the event: Refer to the <a href="#">Severity Level List</a> for more information.           |
| <b>Ether Type</b>      | Shows the EtherType that applies to this event.  |
| <b>Source MAC</b>      | Shows the source MAC address for this traffic.   |
| <b>Destination MAC</b> | Shows the destination MAC address for this traffic.  |
| <b>Action</b>          | Shows the action taken by the firewall for this event: <ul style="list-style-type: none"> <li>• Allow</li> <li>• Deny</li> </ul> |



## Ping Response

Ping Response ▾

🔄 🗖 🗒 🔍 Search

| Index | Timestamp | Severity | EtherType | IP Protocol | Incoming Interface | Source MAC | Source IP | Source Port | Outgoing Interface | Destination IP | Destination Port | TCP Flags | ICMP Type | ICMP Code | Action | Additional message |
|-------|-----------|----------|-----------|-------------|--------------------|------------|-----------|-------------|--------------------|----------------|------------------|-----------|-----------|-----------|--------|--------------------|
|-------|-----------|----------|-----------|-------------|--------------------|------------|-----------|-------------|--------------------|----------------|------------------|-----------|-----------|-----------|--------|--------------------|

Max. 1000 Items per page: 50 0 of 0 |< < > >|

| UI Setting                | Description  |
|---------------------------|--|
| <b>Index</b>              | Shows the index of the event.  |
| <b>Timestamp</b>          | Shows the time of the event, including the date, time, and UTC time zone adjustment.                                   |
| <b>Severity</b>           | Shows the severity categorization of the event: Refer to the <a href="#">Severity Level List</a> for more information. |
| <b>Ether Type</b>         | Shows the EtherType that applies to this event.  |
| <b>IP Protocol</b>        | Shows the IP protocol for this traffic.  |
| <b>Incoming Interface</b> | Shows the incoming interface for this traffic.   |
| <b>Source MAC</b>         | Shows the source MAC address for this traffic.   |
| <b>Source IP</b>          | Shows the source IP address for this traffic.  |
| <b>Source Port</b>        | Shows the source port for this traffic.  |
| <b>Outgoing Interface</b> | Shows the destination interface for this traffic.  |
| <b>Destination IP</b>     | Shows the destination IP address for this traffic.   |
| <b>Destination Port</b>   | Shows the destination port for this traffic.   |
| <b>TCP Flags</b>          | Shows the TCP flags that apply to this event.  |
| <b>ICMP Type</b>          | Shows the ICMP type that applies to this event.  |
| <b>ICMP Code</b>          | Shows the ICMP code that applies to this event.  |

| UI Setting | Description |
|------------|-------------|
|------------|-------------|

|               |  |
|---------------|--|
| <b>Action</b> | Shows the action taken by the firewall for this event. |
|---------------|--|

|                           |   |
|---------------------------|---|
| <b>Additional message</b> | Shows additional information about the event, based on the type of event. |
|---------------------------|---|

## Device Lockdown

 **Note**

Device Lockdown is specifically designed for and will only be available on the NAT series.

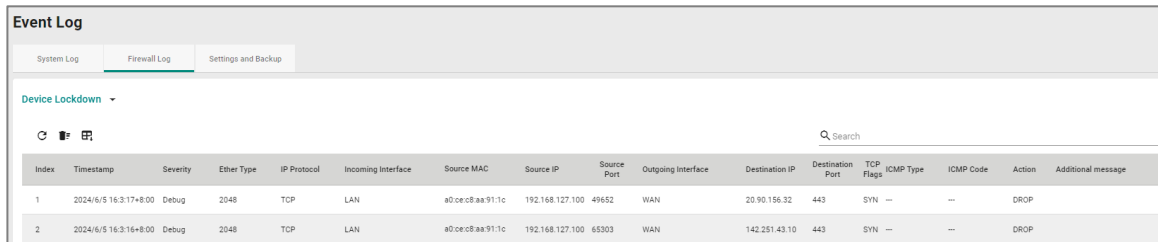

The screenshot shows the 'Event Log' interface with tabs for 'System Log', 'Firewall Log', and 'Settings and Backup'. The 'Device Lockdown' section is expanded, showing a table with columns: Index, Timestamp, Severity, Ether Type, IP Protocol, Incoming Interface, Source MAC, Source IP, Source Port, Outgoing Interface, Destination IP, Destination Port, TCP Flags, ICMP Type, ICMP Code, Action, and Additional message. Two events are listed:

| Index | Timestamp              | Severity | Ether Type | IP Protocol | Incoming Interface | Source MAC        | Source IP       | Source Port | Outgoing Interface | Destination IP | Destination Port | TCP Flags | ICMP Type | ICMP Code | Action | Additional message |
|-------|------------------------|----------|------------|-------------|--------------------|-------------------|-----------------|-------------|--------------------|----------------|------------------|-----------|-----------|-----------|--------|--------------------|
| 1     | 2024/6/5 16:31:17+8:00 | Debug    | 2048       | TCP         | LAN                | a0:ce:c8:aa:91:1c | 192.168.127.100 | 49652       | WAN                | 20.90.156.32   | 443              | SYN       | --        | --        | DROP   |                    |
| 2     | 2024/6/5 16:31:16+8:00 | Debug    | 2048       | TCP         | LAN                | a0:ce:c8:aa:91:1c | 192.168.127.100 | 65303       | WAN                | 142.251.43.10  | 443              | SYN       | --        | --        | DROP   |                    |

| UI Setting | Description |
|------------|-------------|
|------------|-------------|

|              |                               |
|--------------|-------------------------------|
| <b>Index</b> | Shows the index of the event. |
|--------------|-------------------------------|

|                  |  |
|------------------|--|
| <b>Timestamp</b> | Shows the time of the event, including the date, time, and UTC time zone adjustment. |
|------------------|--|

|                 |  |
|-----------------|--|
| <b>Severity</b> | Shows the severity categorization of the event: Refer to the <a href="#">Severity Level List</a> for more information. |
|-----------------|--|

|                   |   |
|-------------------|---|
| <b>Ether Type</b> | Shows the EtherType that applies to this event. |
|-------------------|---|

|                    |   |
|--------------------|---|
| <b>IP Protocol</b> | Shows the IP protocol for this traffic. |
|--------------------|---|

|                           |  |
|---------------------------|--|
| <b>Incoming Interface</b> | Shows the incoming interface for this traffic. |
|---------------------------|--|

|                   |  |
|-------------------|--|
| <b>Source MAC</b> | Shows the source MAC address for this traffic. |
|-------------------|--|

|                  |   |
|------------------|---|
| <b>Source IP</b> | Shows the source IP address for this traffic. |
|------------------|---|

|                    |   |
|--------------------|---|
| <b>Source Port</b> | Shows the source port for this traffic. |
|--------------------|---|

| UI Setting                | Description  |
|---------------------------|--|
| <b>Outgoing Interface</b> | Shows the destination interface for this traffic.      |
| <b>Destination IP</b>     | Shows the destination IP address for this traffic.     |
| <b>Destination Port</b>   | Shows the destination port for this traffic.           |
| <b>TCP Flags</b>          | Shows the TCP flags that apply to this event.          |
| <b>ICMP Type</b>          | Shows the ICMP type that applies to this event.        |
| <b>ICMP Code</b>          | Shows the ICMP code that applies to this event.        |
| <b>Action</b>             | Shows the action taken by the firewall for this event. |
| <b>Additional Message</b> | Shows the additional message for this event.           |

## VPN Log



**Menu Path:** [Diagnostics](#) > [Event Logs and Notifications](#) > [Event Log - VPN Log](#)

This page lets you view your device's VPN-related event logs.

### Limitations

The VPN log can record up to 1000 events.

### Actions

- Click the **Refresh icon** () to refresh the logs.
- Click the **Clear System Log icon** () to delete all logs.
- Click the **Export icon** () to export all logs to a file.

| Index | Timestamp                 | Severity | Additional message                    |
|-------|---------------------------|----------|---------------------------------------|
| 1     | 2020/2/3<br>18:42:41+8:00 | Notice   | [vpn1] Initiating VPN connection      |
| 2     | 2020/2/3<br>18:42:41+8:00 | Notice   | [vpn1] VPN remote gateway unreachable |
| 3     | 2020/2/3<br>18:39:56+8:00 | Notice   | [vpn1] Initiating VPN connection      |

| UI Setting                | Description  |
|---------------------------|--|
| <b>Index</b>              | Shows the index of the event.  |
| <b>Timestamp</b>          | Shows the time of the event, including the date, time, and UTC time zone adjustment. |
| <b>Severity</b>           | Shows the severity categorization of the event.                                      |
| <b>Additional message</b> | Shows additional information about the event, based on the type of event.            |

## Settings and Backup

### Menu Path: [Diagnostics](#) > [Event Logs and Notifications](#) > [Event Log - Settings and Backup](#)

This page lets you clear all the logs or enable automatic event log backups. You can also set up capacity warnings and oversize actions that trigger when log storage has exceeded the specified storage threshold.

#### Clear All Log

Click the **CLEAR** button to clear all event logs.



## Auto Event Log Backup

### Auto Event Log Backup

Automatically Back Up \*

Disabled ▼

---

APPLY

| UI Setting                   | Description                                    | Valid Range               | Default Value |
|------------------------------|--|---------------------------|---------------|
| <b>Automatically Restore</b> | Enable or disable automatic event log backups. | <b>Enabled / Disabled</b> | Disabled      |

## Threshold Settings

### Threshold Settings

↻
🔍 Search

| Status   | Category Name          | Warning Threshold | Oversize Action                | Registered Action |
|----------|------------------------|-------------------|--------------------------------|-------------------|
| Disabled | System                 | ---               | Overwrite the oldest event log | Trap,Email        |
| Disabled | VPN                    | ---               | Overwrite the oldest event log | Trap,Email        |
| Enabled  | Trusted Access         | 50%               | Overwrite the oldest event log | Trap,Email        |
| Enabled  | Malformed Packets      | 50%               | Stop recording event logs      | Trap,Email        |
| Disabled | DoS Policy             | ---               | Overwrite the oldest event log | Trap,Email        |
| Disabled | Layer 3-7 Policy       | ---               | Overwrite the oldest event log | Trap,Email        |
| Disabled | Protocol Filter Policy | ---               | Overwrite the oldest event log | Trap,Email        |
| Disabled | ADP                    | ---               | Overwrite the oldest event log | Trap,Email        |
| Disabled | IPS                    | ---               | Overwrite the oldest event log | Trap,Email        |
| Disabled | Session Control        | ---               | Overwrite the oldest event log | Trap,Email        |
| Disabled | Layer 2 Policy         | ---               | Overwrite the oldest event log | Trap,Email        |

| UI Setting               | Description   |
|--------------------------|---|
| <b>Status</b>            | Shows whether threshold settings are enabled for the category.  |
| <b>Category Name</b>     | Shows which event log the threshold settings apply to.  |
| <b>Warning Threshold</b> | Shows the threshold percentage that must be reached to trigger a warning sent through the <b>Registered Action</b> methods. |
| <b>Oversize Action</b>   | Shows what action will be taken when log storage is full for the selected category.   |
| <b>Registered Action</b> | Shows how threshold warnings will be sent.  |

## Edit Threshold Settings

**Menu Path: Diagnostics > Event Logs and Notifications > Event Log - Settings and Backup**

Clicking the **Edit** (✎) icon for an entry on the **Insert > Path Here** page will open this dialog box. This dialog lets you edit the threshold settings the selected event log category. Click **APPLY** to save your changes.

### Edit System Threshold Settings

Capacity Warning \*

Registered Action

Oversize Action \*

| UI Setting              | Description  | Valid Range        | Default Value |
|-------------------------|--|--------------------|---------------|
| <b>Capacity Warning</b> | Enable or disable capacity warnings for the selected event log category. | Enabled / Disabled | Disabled      |

| UI Setting               | Description  | Valid Range  | Default Value                  |
|--------------------------|--|--|--------------------------------|
| <b>Registered Action</b> | Select how the warning is sent. You can select multiple options.<br><b>Trap:</b> A trap warning will be sent.<br><b>Email:</b> A warning email will be sent.   | Trap / Email   | Trap / Email                   |
| <b>Oversize Action</b>   | Select the oversize action to take when event log storage is full for the selected category.<br><b>Overwrite the oldest event log:</b> The oldest events will be deleted when new events are created.<br><b>Stop recording event logs:</b> No new events will be recorded. | Overwrite the oldest event log / Stop recording event logs | Overwrite the oldest event log |

## Event Notifications

**Menu Path: [Diagnostics](#) > [Event Logs and Notifications](#) > [Event Notifications](#)**

This page lets you configure notifications for various kinds of events.

This page includes these tabs:

- System
- Port
- CPU Usage
- Port Usage

### Event Notifications - System

**Menu Path: [Diagnostics](#) > [Event Logs and Notifications](#) > [Event Notifications - System](#)**

This page lets you configure notification settings for various system events related to the overall functions of the device. Each event can be configured independently with different warning methods and severity classifications.

## Event Notifications

| System                              |            | Port                            |           |                   |  |
|-------------------------------------|------------|---------------------------------|-----------|-------------------|--|
| <input type="text" value="Search"/> |            |                                 |           |                   |  |
| Status                              | Group      | Event Name                      | Severity  | Registered Action |  |
| Disabled                            | General    | Cold Start                      | Emergency |                   |  |
| Disabled                            | General    | Warm Start                      | Emergency |                   |  |
| Disabled                            | General    | Power 1 Transition (On->Off)    | Emergency |                   |  |
| Disabled                            | General    | Power 1 Transition (Off->On)    | Emergency |                   |  |
| Disabled                            | General    | Power 2 Transition (On->Off)    | Emergency |                   |  |
| Disabled                            | General    | Power 2 Transition (Off->On)    | Emergency |                   |  |
| Disabled                            | General    | Configuration Changed           | Emergency |                   |  |
| Disabled                            | General    | Login Failure                   | Emergency |                   |  |
| Disabled                            | General    | 802.1x Authentication Failure   | Emergency |                   |  |
| Disabled                            | General    | Firmware Upgrade Success        | Emergency |                   |  |
| Disabled                            | General    | Firmware Upgrade Failure        | Emergency |                   |  |
| Disabled                            | General    | Log Service Ready               | Emergency |                   |  |
| Disabled                            | Redundancy | Ring/RSTP Topology Changed      | Emergency |                   |  |
| Disabled                            | Redundancy | Master Mismatch                 | Emergency |                   |  |
| Disabled                            | Redundancy | Coupling Topology Changed       | Emergency |                   |  |
| Disabled                            | Redundancy | VRRP State Change               | Emergency |                   |  |
| Disabled                            | VPN        | VPN Connected                   | Emergency |                   |  |
| Disabled                            | VPN        | VPN Disconnected                | Emergency |                   |  |
| Disabled                            | Firewall   | Firewall Policy Changed         | Emergency |                   |  |
| Disabled                            | PoE        | PoE PD On                       | Emergency |                   |  |
| Disabled                            | PoE        | PoE PD Off                      | Emergency |                   |  |
| Disabled                            | PoE        | Over Measured Power limitation  | Emergency |                   |  |
| Disabled                            | PoE        | PoE FETBad                      | Emergency |                   |  |
| Disabled                            | PoE        | PoE Over Temperature            | Emergency |                   |  |
| Disabled                            | PoE        | PoE VEE Uvlo                    | Emergency |                   |  |
| Disabled                            | PoE        | PoE PD Over Current             | Emergency |                   |  |
| Disabled                            | PoE        | PoE PD Check Fail               | Emergency |                   |  |
| Disabled                            | PoE        | Over Allocated Power limitation | Emergency |                   |  |



| UI Setting               | Description  |
|--------------------------|--|
| <b>Status</b>            | Shows whether event notifications are enabled for this kind of event.  |
| <b>Group</b>             | Shows which group this event belongs to.   |
| <b>Event Name</b>        | Shows the name of the event. Refer to the <a href="#">System Event List</a> for more details.  |
| <b>Severity</b>          | Shows the severity assigned to the event. Refer to the <a href="#">Severity Level List</a> for more details.   |
| <b>Registered Action</b> | Shows which action will be taken for this kind of event.<br><b>Trap:</b> A notification is sent to the Trap server when the event is triggered.<br><b>Email:</b> A notification is sent to the email server defined in the <a href="#">Email Settings</a> section.<br><b>Syslog:</b> An event log is recorded to the Syslog server defined in the <a href="#">Syslog</a> section.<br><b>Relay:</b> A notification is sent through the relay interface, if the device has one, when the event is triggered. |
|                          | <p> <b>Note</b></p> <p>The types of actions available may vary depending on the event type and the device model.</p>  |

## Event Notifications - System - Edit Event Notification

**Menu Path:** [Diagnostics](#) > [Event Logs and Notifications](#) > [Event Notifications - System](#)

Clicking the **Edit (✎)** icon for an entry on the **Diagnostics > Event Logs and Notifications > Event Notifications - System** page will open this dialog box. This dialog lets you change the notification settings for the selected event. Click **APPLY** to save your changes.

### Edit Event Notification

Event Name  
Cold Start

---

Status \*  
Disabled ▼

Registered Action ▼

Severity \*  
Emergency ▼

CANCEL
APPLY













| UI Setting                    | Description   | Valid Range   | Default Value |
|-------------------------------|---|---|---------------|
| <b>Event Name (View-only)</b> | Shows the name of the event. Refer to the <a href="#">System Event List</a> for more information.   | (Fixed)   | (Fixed)       |
| <b>Status</b>                 | Enable or disable notifications for this event.   | Enabled / Disabled  | Disabled      |
| <b>Registered Action</b>      | <p>Select which action to take when the event occurs. Multiple actions may be selected.</p> <p><b>Trap:</b> A notification will be sent to the Trap server.</p> <p><b>Email:</b> A notification email will be sent to the email server defined in the <a href="#">Email Settings</a> section.</p> <p><b>Syslog:</b> The event log is recorded to a Syslog server defined in the <a href="#">Syslog</a> section.</p> <p><b>Relay:</b> An alarm notification will be triggered through the relay output of the device, if your device is equipped with one.</p> | Trap / Email / Syslog / Relay   | N/A           |
| <b>Severity</b>               | Select the severity to assign for this event. Refer to the <a href="#">Severity Level List</a> for more information about the different severity levels.  | Emergency / Alert / Critical / Error / Warning / Notice / Informational / Debug | Emergency     |

## Event Notifications - Port

### Menu Path: Diagnostics > Event Logs and Notifications > Event Notifications - Port

This page lets you configure notification settings for various events related to your device's physical port status. Each port can be configured independently with different warning methods and severity classifications.

When a port event is triggered, the FAULT LED on your device will also light up if your device has one.

| Event Notifications  |      |          |          |           |                   |
|--|------|----------|----------|-----------|-------------------|
| System   | Port |          |          |           |                   |
|  |      |          |          |           | Search            |
| Status   | Port | Link-On  | Link-Off | Severity  | Registered Action |
|  Disabled   | 1    | Disabled | Disabled | Emergency |                   |
|  Disabled   | 2    | Disabled | Disabled | Emergency |                   |
|  Disabled   | 3    | Disabled | Disabled | Emergency |                   |
|  Disabled | 4    | Disabled | Disabled | Emergency |                   |
|  Disabled | 5    | Disabled | Disabled | Emergency |                   |
|  Disabled | 6    | Disabled | Disabled | Emergency |                   |
|  Disabled | 7    | Disabled | Disabled | Emergency |                   |
|  Disabled | 8    | Disabled | Disabled | Emergency |                   |
|  Disabled | G1   | Disabled | Disabled | Emergency |                   |
|  Disabled | G2   | Disabled | Disabled | Emergency |                   |
|  Disabled | G3   | Disabled | Disabled | Emergency |                   |
|  Disabled | G4   | Disabled | Disabled | Emergency |                   |

| UI Setting               | Description  |
|--------------------------|--|
| <b>Status</b>            | Shows whether event notifications are enabled for this kind of event.  |
| <b>Port</b>              | Shows which group this event belongs to.   |
| <b>Link-On</b>           | Shows whether notifications for Link-On events are enabled or disabled.                                      |
| <b>Link-Off</b>          | Shows whether notifications for Link-Off events are enabled or disabled.                                     |
| <b>Severity</b>          | Shows the severity assigned to the event. Refer to the <a href="#">Severity Level List</a> for more details. |
| <b>Registered Action</b> | Shows how notifications will be sent for this kind of event.   |

## Event Notifications - Port - Edit Event Notification

**Menu Path:** [Diagnostics > Event Logs and Notifications > Event Notifications - Port](#)

Clicking the **Edit** (✎) icon for an entry on the **Diagnostics > Event Logs and Notifications > Event Notifications - System** page will open this dialog box. This dialog lets you change the notification settings for the selected port. Click **APPLY** to save your changes.

### Edit Event Notification

Port  
1

---

Status \*  
Disabled ▼

Link-On \*  
Disabled ▼

Link-Off \*  
Disabled ▼

Registered Action ▼

Severity \*  
Emergency ▼

CANCEL APPLY

| UI Setting                 | Description  | Valid Range        | Default Value |
|----------------------------|--|--------------------|---------------|
| <b>Port</b><br>(View-only) | Shows which physical port the event notifications are for.<br><br><div style="background-color: #f0f0f0; padding: 5px; margin-top: 5px;"> <p><b>Note</b><br/>Available ports will vary depending on your product and model.</p> </div> | N/A                | N/A           |
| <b>Status</b>              | Enable or disable notifications for this port.   | Enabled / Disabled | Disabled      |

| UI Setting               | Description  | Valid Range   | Default Value |
|--------------------------|--|---|---------------|
| <b>Link-On</b>           | Enable or disable notifications for Link-On events. If enabled, an event will be triggered when a device connects to the port.   | Enabled / Disabled  | Disabled      |
| <b>Link-Off</b>          | Enable or disable notifications for Link-Off events. If enabled, an event will be triggered when the port is disconnected from a device, such as when a cable is unplugged or the connected device is shut down.   | Enabled / Disabled  | Disabled      |
| <b>Registered Action</b> | Select which action to take when the event occurs. Multiple actions may be selected.<br><b>Trap:</b> A notification will be sent to the Trap server.<br><b>Email:</b> A notification email will be sent to the email server defined in the <a href="#">Email Settings</a> section.<br><b>Syslog:</b> The event log is recorded to a Syslog server defined in the <a href="#">Syslog</a> section.<br><b>Relay:</b> An alarm notification will be triggered through the relay output of the device, if your device is equipped with one. | Trap / Email / Syslog / Relay   | N/A           |
| <b>Severity</b>          | Select the severity to assign for this event. Refer to the <a href="#">Severity Level List</a> for more information about the different severity levels.   | Emergency / Alert / Critical / Error / Warning / Notice / Informational / Debug | Emergency     |

## Event Notifications - CPU Usage

### Menu Path: [Diagnostics](#) > [Event Logs and Notifications](#) > [Event Notifications - CPU Usage](#)

This page lets you configure notification settings based on CPU usage.

| Event Notifications |                 |              |               |          |                   |
|---------------------|-----------------|--------------|---------------|----------|-------------------|
| System              |                 |              |               |          |                   |
| Port                |                 |              |               |          |                   |
| CPU Usage           |                 |              |               |          |                   |
| Port Usage          |                 |              |               |          |                   |
| Search              |                 |              |               |          |                   |
| Status              | Event Name      | Threshold(%) | Duration(Sec) | Severity | Registered Action |
| Disabled            | CPU Usage Alarm | 80           | 10            | Warning  |                   |

| UI Setting    | Description   |
|---------------|---|
| <b>Status</b> | Shows whether event notifications are enabled for this kind of event. |

| UI Setting               | Description  |
|--------------------------|--|
| <b>Event Name</b>        | Shows which group this event belongs to.   |
| <b>Threshold(%)</b>      | Shows the CPU usage threshold percentage that must be exceeded for event notifications.                      |
| <b>Duration(Sec)</b>     | Shows the amount of time in seconds CPU usage must exceed the threshold to trigger a notification.           |
| <b>Severity</b>          | Shows the severity assigned to the event. Refer to the <a href="#">Severity Level List</a> for more details. |
| <b>Registered Action</b> | Shows how notifications will be sent for this kind of event.   |

## Event Notifications - CPU Usage - Edit Event Notification

### Menu Path: Diagnostics > Event Logs and Notifications > Event Notifications - CPU Usage

Clicking the **Edit (✎)** icon for an entry on the **Diagnostics > Event Logs and Notifications > Event Notifications - CPU Usage** page will open this dialog box. This dialog lets you change the notification settings for CPU usage. Click **APPLY** to save your changes.

The screenshot shows a dialog box titled "Edit Event Notification" for a "CPU Usage Alarm". The settings are as follows:

- Event Name: CPU Usage Alarm
- Status: Disabled
- Threshold(%): 80 (Valid range: 60 - 90 %)
- Duration(Sec): 10 (Valid range: 10 - 60 sec)
- Registered Action: (Dropdown menu)
- Severity: Warning (Dropdown menu)

Buttons for "CANCEL" and "APPLY" are located at the bottom right of the dialog.

| UI Setting                    | Description                     | Valid Range | Default Value |
|-------------------------------|---------------------------------|-------------|---------------|
| <b>Event Name (View-only)</b> | Shows the CPU usage event name. | N/A         | N/A           |

| UI Setting               | Description  | Valid Range   | Default Value |
|--------------------------|--|---|---------------|
| <b>Status</b>            | Enable or disable event notifications for CPU usage.   | Enabled / Disabled  | Disabled      |
| <b>Threshold(%)</b>      | Shows the CPU usage threshold percentage that must be exceeded for event notifications.                      | 60 to 90  | 80            |
| <b>Duration(Sec)</b>     | Shows the amount of time in seconds CPU usage must exceed the threshold to trigger a notification.           | 10 to 60  | 10            |
| <b>Severity</b>          | Shows the severity assigned to the event. Refer to the <a href="#">Severity Level List</a> for more details. | Email / Syslog  | N/A           |
| <b>Registered Action</b> | Shows how notifications will be sent for this kind of event.   | Emergency / Alert / Critical / Error / Warning / Notice / Informational / Debug | Warning       |

## Event Notifications - Port Usage

### Menu Path: [Diagnostics](#) > [Event Logs and Notifications](#) > [Event Notifications - Port Usage](#)

This page lets you configure notification settings based on port usage. Each port can be configured independently with different warning methods and severity classifications.

| Event Notifications |                  |           |            |                 |                  |          |                 |                  |          |                   |
|---------------------|------------------|-----------|------------|-----------------|------------------|----------|-----------------|------------------|----------|-------------------|
| System              | Port             | CPU Usage | Port Usage |                 |                  |          |                 |                  |          |                   |
| Status              | Event Name       | Port      | Tx         | Tx Threshold(%) | Tx Duration(Sec) | Rx       | Rx Threshold(%) | Rx Duration(Sec) | Severity | Registered Action |
| Disabled            | Port Usage Alarm | 3         | Disabled   | 50              | 10               | Disabled | 50              | 10               | Warning  |                   |
| Disabled            | Port Usage Alarm | 4         | Disabled   | 50              | 10               | Disabled | 50              | 10               | Warning  |                   |
| Disabled            | Port Usage Alarm | 5         | Disabled   | 50              | 10               | Disabled | 50              | 10               | Warning  |                   |
| Disabled            | Port Usage Alarm | 6         | Disabled   | 50              | 10               | Disabled | 50              | 10               | Warning  |                   |
| Disabled            | Port Usage Alarm | 8         | Disabled   | 50              | 10               | Disabled | 50              | 10               | Warning  |                   |
| Disabled            | Port Usage Alarm | G1        | Disabled   | 50              | 10               | Disabled | 50              | 10               | Warning  |                   |
| Disabled            | Port Usage Alarm | G2        | Disabled   | 50              | 10               | Disabled | 50              | 10               | Warning  |                   |

Items per page: 50 | 1 - 7 of 7 | < > >>

| UI Settings              | Description   |
|--------------------------|---|
| <b>Status</b>            | Shows whether event notifications are enabled for this kind of event.   |
| <b>Port</b>              | Shows which port this event belongs to.<br><br>Available ports will vary depending on your product and model. |
| <b>Tx</b>                | Shows whether Tx traffic is being monitored for event notifications.  |
| <b>Tx Threshold(%)</b>   | Shows the Tx threshold percentage that must be exceeded for event notifications.                              |
| <b>Tx Duration</b>       | Shows the amount of time in seconds Tx traffic must exceed the Tx threshold to trigger a notification.        |
| <b>Rx</b>                | Shows whether Rx traffic is being monitored for event notifications.  |
| <b>Rx Threshold(%)</b>   | Shows the set Rx threshold percentage that must be exceeded for event notifications.                          |
| <b>Rx Duration(Sec)</b>  | Shows the amount of time in seconds Rx traffic must exceed the Rx threshold to trigger a notification.        |
| <b>Severity</b>          | Shows the severity assigned to the event. Refer to the <a href="#">Severity Level List</a> for more details.  |
| <b>Registered Action</b> | Shows how notifications will be sent for this kind of event.  |

## Event Notifications - Port Usage - Edit Event Notification

### Menu Path: [Diagnostics > Event Logs and Notifications > Event Notifications - Port Usage](#)

Clicking the **Edit (✎)** icon for an entry on the **Diagnostics > Event Logs and Notifications > Event Notifications - Port Usage** page will open this dialog box. This dialog lets you change the notification settings for the selected port. Click **APPLY** to save your changes.



### Edit Event Notification

Port  
3

---

Event Name  
Port Usage Alarm

---

Status \*  
Disabled

---

|          |                   |                    |
|----------|-------------------|--------------------|
| Tx *     | Tx Threshold(%) * | Tx Duration(Sec) * |
| Disabled | 50                | 10                 |
|          | 1 - 100 %         | 1 - 300 sec.       |

---

|          |                   |                    |
|----------|-------------------|--------------------|
| Rx *     | Rx Threshold(%) * | Rx Duration(Sec) * |
| Disabled | 50                | 10                 |
|          | 1 - 100 %         | 1 - 300 sec.       |

---

Registered Action

---

Severity \*  
Warning

---

CANCEL
APPLY

| UI Setting                    | Description   | Valid Range        | Default Value |
|-------------------------------|---|--------------------|---------------|
| <b>Port (View-only)</b>       | Shows which physical port the event notifications are for.<br><div style="background-color: #e0e0e0; padding: 5px; margin-top: 5px;">Available ports will vary depending on your product and model.</div> | N/A                | N/A           |
| <b>Event Name (View-only)</b> | Shows the event name.   | N/A                | N/A           |
| <b>Tx</b>                     | Enable or disable Tx monitoring for event notifications.  | Enabled / Disabled | Disabled      |
| <b>Tx Threshold(%)</b>        | Specify the Tx threshold percentage that must be exceeded for event notifications.  | 1 to 100           | 50            |
| <b>Tx Duration</b>            | Specify the amount of time in seconds Tx traffic must exceed the Tx threshold to trigger a notification.  | 1 to 300           | 10            |
| <b>Rx</b>                     | Enable or disable Rx monitoring for event notifications.  | Enabled / Disabled | Disabled      |
| <b>Rx Threshold(%)</b>        | Specify the Rx threshold percentage that must be exceeded for event notifications.  | 1 to 100           | 50            |

| UI Setting               | Description  | Valid Range   | Default Value |
|--------------------------|--|---|---------------|
| <b>Rx Duration(Sec)</b>  | Specify the amount of time in seconds Rx traffic must exceed the Rx threshold to trigger a notification.   | 1 to 300  | 10            |
| <b>Registered Action</b> | Select which action to take when the event occurs. Multiple actions may be selected.<br><br><b>Email:</b> A notification email will be sent to the email server defined in the <a href="#">Email Settings</a> section.<br><br><b>Syslog:</b> The event log is recorded to a Syslog server defined in the <a href="#">Syslog</a> section. | Email / Syslog  | N/A           |
| <b>Severity</b>          | Select the severity to assign for this event. Refer to the <a href="#">Severity Level List</a> for more information about the different severity levels.   | Emergency / Alert / Critical / Error / Warning / Notice / Informational / Debug | Warning       |

## Syslog

### Menu Path: [Diagnostics](#) > [Event Logs and Notifications](#) > [Syslog](#)

This page lets you configure your device to connect to syslog servers to store event logs. When an event occurs, an event notification can be sent as a syslog UDP packet to the specified Syslog servers. Each syslog server can be enabled individually.

Administrators can manually import self-signed certificates for syslog client services. However, they should check the root certificate and validity of the signature before importing, according to the organization's security procedures and requirements. After importing a certificate, the administrator should check if the certificate has been revoked and if so, the certificate must be replaced. When the device sends an imported certificate to the syslog server, the syslog server will attempt to verify the certificate by searching the approved certificate pool on the server to identify the imported certificate.

#### **Note**

To centralize data collection and potentially use it for forensic purposes in the future, we recommend that users deploy a syslog server in their environment and enable the syslog functionality on their devices to send logs to the remote server for storage. Additionally, we strongly recommend that these logs be properly stored on a syslog server for at least one year.

It is advised that the syslog server administrator utilize software or design automated processes for syslog management (including protection, collection, etc.).

For syslog management, it is essential to establish SOPs or any automated protection mechanisms to prevent authorized users from inadvertently deleting logs stored on the syslog server.

#### **Note**

In order to ensure the security of your network, we recommend the following:

- The encryption algorithm of keys should be selected based on internationally recognized and proven security practices and recommendations.
- The lifetime of certificates generated for syslog client services should be short and in accordance with the organization's security procedures and requirements.
- For security reasons, it is recommended to send event logs to a centralized syslog server for continuous network event monitoring.

#### **Limitations**

You can connect to up to 3 syslog servers.

### Syslog

Syslog 1 \* Certificate 1

Disabled Disabled

Address 1 UDP Port 1

1 - 65535

Message Format 1

RFC 3164

Syslog 2 \* Certificate 2

Disabled Disabled

Address 2 UDP Port 2

1 - 65535

Message Format 2

RFC 3164

Syslog 3 \* Certificate 3

Disabled Disabled

Address 3 UDP Port 3

1 - 65535

Message Format 3

RFC 3164

[APPLY](#)

| UI Setting            | Description   | Valid Range                               | Default Value |
|-----------------------|---|---|---------------|
| <b>Syslog</b>         | Enable or disable the specified syslog server.  | Enabled / Disabled                        | Disabled      |
| <b>Certificate</b>    | Select a syslog server certificate to use for the related server, or disable use of certificates. | Drop-down list of certificates / Disabled | Disabled      |
| <b>Address</b>        | Enter the IP address of the related syslog server.  | Valid IP address                          | N/A           |
| <b>UDP Port</b>       | Specify the UDP port of the related syslog server.  | 1 to 65535                                | 514           |
| <b>Message Format</b> | Select the message format of syslog.  | RFC 3164 / RFC 5424                       | RFC 3164      |

## SNMP Trap/Inform

**Menu Path:** [Diagnostics > Event Logs and Notifications > SNMP Trap/Inform](#)

This page lets you configure the SNMP Trap/Inform notification feature.

This page includes these tabs:

- General
- SNMP Account

## SNMP Trap/Inform - General

**Menu Path: Diagnostics > Event Logs and Notifications > SNMP Trap/Inform - General**

This page lets you configure the SNMP Trap/Inform settings of your device. Click **APPLY** to save your changes.

### SNMP Trap/Inform

General
SNMP Account

Trap Mode \*  
Trap V1 ▼

Trap Community 1 \*  
public 6 / 64

Recipient IP/Name 1 Recipient IP/Name 2

Recipient IP/Name 3

Inform Retries  
3

1 - 99 times

Inform Timeout  
10

1 - 300 sec.

APPLY

| UI Setting                     | Description  | Valid Range   | Default Value |
|--------------------------------|--|---|---------------|
| <b>Trap Mode</b>               | Select a mode to use for SNMP notifications. Trap notifications are sent without requesting an acknowledgement from the recipient. Inform notifications will request an acknowledgement from the recipient, and will retry sending the notification if the acknowledgement is not received.<br><br><b>Trap V1:</b> Use Trap V1 for SNMP notifications.<br><b>Trap V2:</b> Use Trap V2 for SNMP notifications.<br><b>Inform V2:</b> Use Inform V2 for SNMP notifications.<br><b>Trap V3:</b> Use Trap V3 for SNMP notifications.<br><b>Inform V3:</b> Use Inform V3 for SNMP notifications. | Trap V1 / Trap V2 / Inform V2 / Trap V3 / Inform V3 | Trap V1       |
| <b>Trap Community 1</b>        | Specify the community string that will be used for authentication.   | 1 to 64 characters                                  | public        |
| <b>Recipient IP/Name 1/2/3</b> | Specify the name of the recipient trap server that will receive notifications.   | Recipient IP or name                                | N/A           |

| UI Setting  | Description  | Valid Range | Default Value |
|---|--|-------------|---------------|
| <b>Inform Retries</b><br>(if Trap Mode is Inform V2 or Inform V3) | Specify the number of times to retry sending an inform notification.   | 1 to 99     | 3             |
| <b>Inform Timeout</b><br>(if Trap Mode is Inform V2 or Inform V3) | Specify the amount of time to wait (in seconds) to wait for an acknowledgement before trying to resend an inform notification. | 1 to 300    | 10            |

## SNMP Account

**Menu Path: Diagnostics > Event Logs and Notifications > SNMP Trap/Inform - SNMP Account**

This section lets you configure an SNMP trap account for your device.

### Limitations

You can configure up to 1 SNMP trap account.

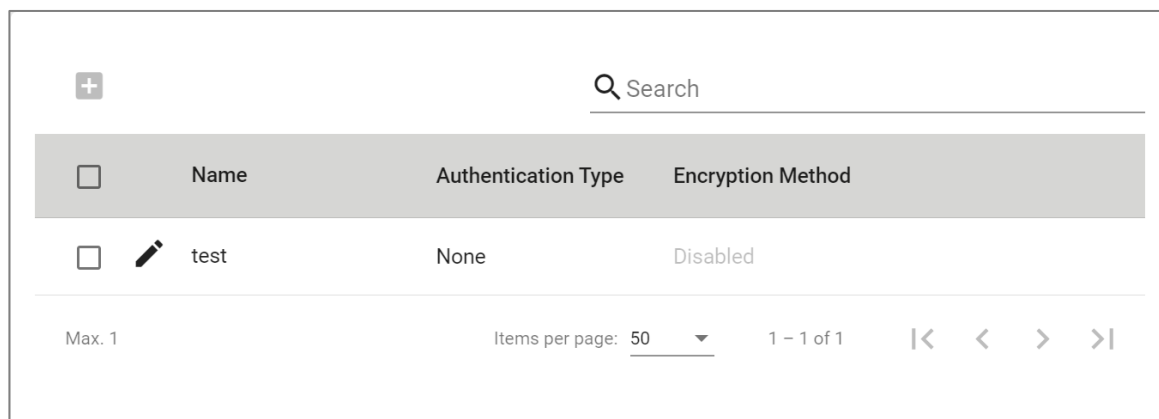

| <input type="checkbox"/> | Name   | Authentication Type | Encryption Method |
|--------------------------|--|---------------------|-------------------|
| <input type="checkbox"/> |  test | None                | Disabled          |

Max. 1      Items per page: 50      1 - 1 of 1      << < > >>

| UI Setting                 | Description  |
|----------------------------|--|
| <b>Name</b>                | Shows the name of the SNMP trap account.                   |
| <b>Authentication Type</b> | Shows which authentication method is used for the account. |

| UI Setting               | Description  |
|--------------------------|--|
| <b>Encryption Method</b> | Shows which encryption method is used for the account. |

## Create SNMP Trap Account Settings

**Menu Path: Diagnostics > Event Logs and Notifications > SNMP Trap/Inform - SNMP Account**

Clicking the **Add (+)** icon on the **Diagnostics > Event Logs and Notifications > SNMP Trap/Inform - SNMP Account** page will open this dialog box. This dialog lets you add an SNMP trap account for your device. Click **CREATE** to save your changes and add the new account.

| UI Setting   | Description  | Valid Range        | Default Value |
|--|--|--------------------|---------------|
| <b>Name</b>  | Specify a name for the account.  | 1 to 32 characters | N/A           |
| <b>Authentication Type</b>                                       | Select which authentication method to use for the account.<br><b>None:</b> No authentication will be used.<br><b>MD5:</b> Use MD5 authentication.<br><b>SHA:</b> Use SHA authentication. | None / MD5 / SHA   | None          |
| <b>Authentication Key (if Authentication Type is MD5 or SHA)</b> | Specify an authentication key to use for the account.  | 8 to 64 characters | N/A           |
| <b>Encryption Method</b>   | Enable or disable AES encryption for the account.  | Enabled / Disabled | Disabled      |

| UI Setting   | Description                                     | Valid Range        | Default Value |
|--|---|--------------------|---------------|
| <b>Encryption Key</b><br>(if Encryption Method is Enabled) | Specify an encryption password for the account. | 8 to 64 characters | N/A           |

## Edit SNMP Trap Account Settings

**Menu Path:** [Diagnostics](#) > [Event Logs and Notifications](#) > [SNMP Trap/Inform - SNMP Account](#)

Clicking the **Edit** (✎) icon for an entry on the **Diagnostics > Event Logs and Notifications > SNMP Trap/Inform - SNMP Account** page will open this dialog box. This dialog lets you modify an existing SNMP trap account. Click **APPLY** to save your changes.

### Edit SNMP Trap Account Settings

Name \*  
test  
4 / 31

Authentication Type \*  
MD5 ▼ Authentication Key \* At least 8 characters 0 / 30

Encryption Method \*  
Enabled ▼ Encryption Key \* At least 8 characters 0 / 30

CANCEL
APPLY

| UI Setting                 | Description  | Valid Range        | Default Value |
|----------------------------|--|--------------------|---------------|
| <b>Name</b>                | Specify a name for the account.  | 1 to 32 characters | N/A           |
| <b>Authentication Type</b> | Select which authentication method to use for the account.<br><b>None:</b> No authentication will be used.<br><b>MD5:</b> Use MD5 authentication.<br><b>SHA:</b> Use SHA authentication. | None / MD5 / SHA   | None          |



| UI Setting  | Description   | Valid Range        | Default Value |
|---|---|--------------------|---------------|
| <b>Authentication Key</b><br>(if Authentication Type is MD5 or SHA) | Specify an authentication key to use for the account. | 8 to 64 characters | N/A           |
| <b>Encryption Method</b>  | Enable or disable AES encryption for the account.     | Enabled / Disabled | Disabled      |
| <b>Encryption Key</b><br>(if Encryption Method is Enabled)          | Specify an encryption password for the account.       | 8 to 64 characters | N/A           |

## Delete SNMP Trap Account

### Menu Path: [Diagnostics](#) > [Event Logs and Notifications](#) > [SNMP Trap/Inform - SNMP Account](#)

You can delete an account by using the checkboxes to select the entries you want to delete, then clicking the **Delete** (  ) icon.

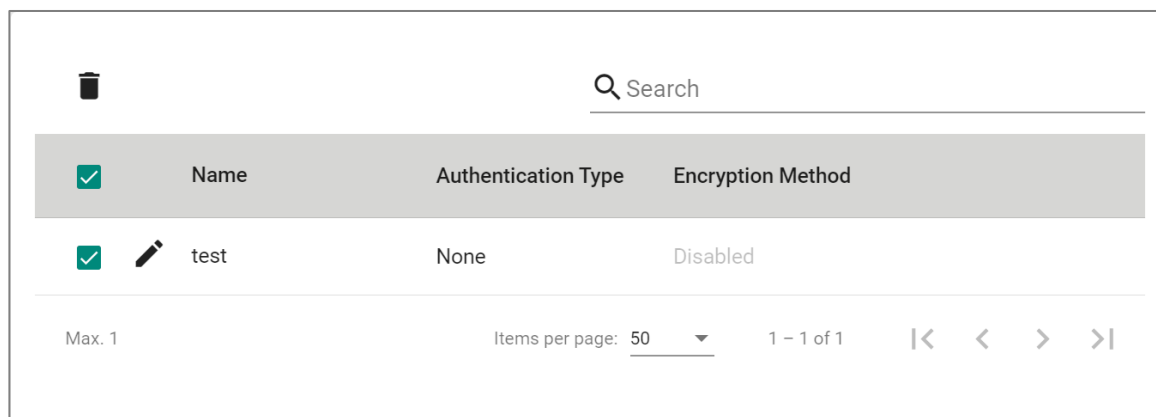

## Email Settings

### Menu Path: [Diagnostics](#) > [Event Logs and Notifications](#) > [Email Settings](#)

This page lets you configure your device's email notification settings. You can specify which mail server and account to use, and which email addresses to send email notifications to. Click **APPLY** to save your changes, or click **SEND TEST MAIL** to send a test email using the current settings and recipients.

**Note**

Auto warning email messages will be sent through an authentication-protected SMTP server that supports CRAM-MD5, LOGIN, and PAIN methods of SASL (Simple Authentication and Security Layer) authentication.

We strongly recommend not entering your Account Name and Account Password if auto warning e-mail messages can be delivered without using an authentication mechanism.

**Email Settings**

Mail Server 0 / 60

TCP Port  
**25**  
1 - 65535

Username 0 / 60 Password 0 / 60

Sender Address 0 / 60

1st Recipient Email Add... 0 / 60 2nd Recipient Email Ad... 0 / 60

3rd Recipient Email Add... 0 / 60 4th Recipient Email Add... 0 / 60

**APPLY** **SEND TEST EMAIL**

| UI Setting         | Description   | Valid Range        | Default Value |
|--------------------|---|--------------------|---------------|
| <b>Mail Server</b> | Specify the address of the email server. You can enter a domain name or IP address. | 1 to 60 characters | N/A           |
| <b>TCP Port</b>    | Specify the TCP port of the email server.   | 1 to 65535         | 25            |
| <b>Username</b>    | Specify the username used to log in to the email server.                            | 0 to 60 characters | N/A           |
| <b>Password</b>    | Specify the password used to log in to the email server.                            | 0 to 60 characters | N/A           |

| UI Setting                     | Description  | Valid Range        | Default Value |
|--------------------------------|--|--------------------|---------------|
| <b>Sender Address</b>          | Specify the sender email address to use for email notifications.   | 0 to 60 characters | N/A           |
| <b>Recipient Email Address</b> | Enter an email address to send email notifications to. You can set up to 4 email addresses to receive email notifications. | 0 to 60 characters | N/A           |

## SMS Settings

**Menu Path: Diagnostics > Event Logs and Notifications > SMS Settings**

This page lets you configure your device's SMS notification settings. You can specify which phone number to send SMS notifications to.

**Note**

Availability of this feature may vary depending on your product model and version.

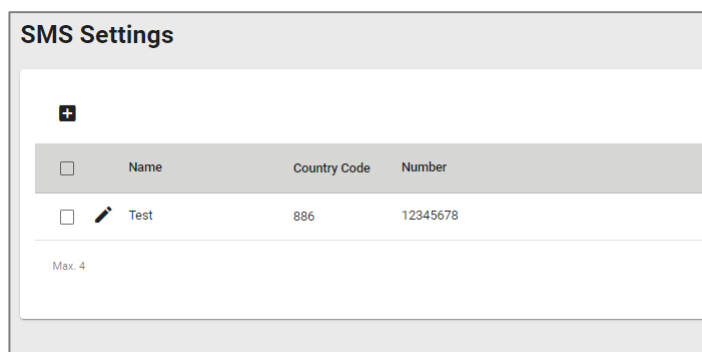

| UI Setting          | Description                                    |
|---------------------|--|
| <b>Name</b>         | Shows the SMS recipient's name.                |
| <b>Country Code</b> | Shows the SMS recipient number's country code. |
| <b>Number</b>       | Shows the SMS recipient's phone number.        |

## Add SMS Number

**Menu Path:** [Diagnostics > Event Logs and Notifications > SMS Settings](#)

Clicking the **Add (+)** icon on the **Diagnostics > Event Logs and Notifications > SMS Settings** page will open this dialog box. This dialog lets you add an SMS recipient for your device notification. Click **CREATE** to save your changes and add the new SMS recipient.

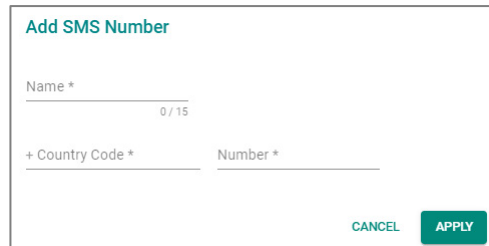

**Add SMS Number**

Name \*  0 / 15

+ Country Code \*  Number \*

CANCEL APPLY

| UI Setting          | Description                                    | Valid Range        | Default Value |
|---------------------|--|--------------------|---------------|
| <b>Name</b>         | Enter the SMS recipient's name.                | 1 to 15 characters | N/A           |
| <b>Country Code</b> | Enter the SMS recipient number's country code. | Country code       | N/A           |
| <b>Number</b>       | Enter the SMS recipient's phone number.        | Phone number       | N/A           |

## Edit SMS Settings

**Menu Path:** [Diagnostics > Event Logs and Notifications > SMS Settings](#)

Clicking the **Edit (✎)** icon for an entry on the **Diagnostics > Event Logs and Notifications > SMS Settings** page will open this dialog box. This dialog lets you modify an existing SMS recipient. Click **APPLY** to save your changes.

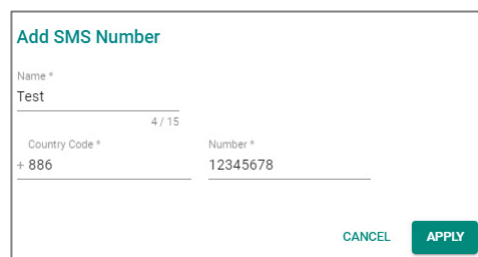

**Add SMS Number**

Name \*  Test 4 / 15

Country Code \*  + 886 Number \*  12345678

CANCEL APPLY

| UI Setting          | Description                                    | Valid Range        | Default Value |
|---------------------|--|--------------------|---------------|
| <b>Name</b>         | Enter the SMS recipient's name.                | 1 to 15 characters | N/A           |
| <b>Country Code</b> | Enter the SMS recipient number's country code. | Country code       | N/A           |
| <b>Number</b>       | Enter the SMS recipient's phone number.        | Phone number       | N/A           |

## Delete SMS Number

You can delete SMS recipients by using the checkboxes to select the entries you want to delete, then clicking the **Delete (🗑)** icon.

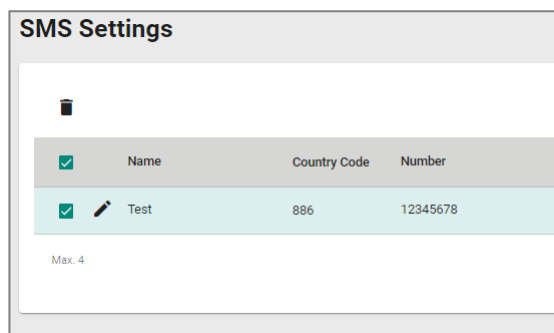

## Tools

### Menu Path: Diagnostics > Tools

This section lets you use various tools to check for network issues.

This section includes these pages:

- Port Mirroring
- Ping
- Diagnostic Support
- NetFlow

# Port Mirroring

## Menu Path: Diagnostics > Tools > Port Mirroring

This page lets you configure the port mirror function, which can be used to monitor data being transmitted through a specific port. This is done by setting up another port (the mirror port) to receive the same data being transmitted from, or both to and from, the port under observation.

Using a mirror port allows the network administrator to sniff the observed port to keep tabs on network activity.

**Note**

For security reasons, it is recommended to use port mirroring to send traffic to an intrusion detection system (IDS) for analysis.

**Port Mirroring**

Port Mirroring Configuration

Enable \*  
Enabled

Monitored Port \*

Monitored Traffic \*  
All Streams

Mirror Destination Port \*  
1

APPLY

| UI Setting            | Description  | Valid Range  | Default Value |
|-----------------------|--|--|---------------|
| <b>Enable</b>         | Enable or disable the port mirror function.  | Enabled / Disabled   | Disabled      |
| <b>Monitored Port</b> | Select the numbers for the ports you want to monitor for network activity. Multiple ports can be selected. | (Selectable ports will vary depending on the device model) | N/A           |

| UI Setting                     | Description  | Valid Range  | Default Value |
|--------------------------------|--|--|---------------|
| <b>Monitored Traffic</b>       | Select the type of traffic that will be monitored.<br><b>Ingress Stream:</b> Select this option to monitor only those data packets coming into the Moxa industrial secure router's port.<br><b>Egress Stream:</b> Select this option to monitor only those data packets being sent out through the Moxa industrial secure router's port.<br><b>All Streams:</b> Select this option to monitor data packets both coming into and being sent out through the Moxa industrial secure router's port. | Ingress Stream / Egress Stream / All Streams               | All Streams   |
| <b>Mirror Destination Port</b> | Select the number of the port that will be used to monitor the activity of the monitored port.   | (Selectable ports will vary depending on the device model) | 1             |

## Ping

### Menu Path: [Diagnostics](#) > [Tools](#) > [Ping](#)

This page lets you use the ping function, which is useful for troubleshooting network problems.

The function's most unique feature is that even though the ping command is entered from the user's PC keyboard, the actual ping command originates from the device itself. In this way, you can use your device to send ping commands out through its ports.

| UI Setting                    | Description   | Valid Range   | Default Value |
|-------------------------------|---|---|---------------|
| <b>IP Address/Domain Name</b> | Specify the IP address or domain name you want to ping, then click the <b>PING</b> button. The ping result will be displayed below. | Valid IP address or domain name up to 50 characters | N/A           |

## Diagnostic Support

**Menu Path:** [Diagnostics > Tools > Diagnostic Support](#)

This page lets you generate files and import files for troubleshooting.

This page includes these tabs:

- System Profile
- Module Firmware

### **Note**

Please note that settings and available options may vary depending on the product model.

## System Profile

**Menu Path:** [Diagnostics > Tools > Diagnostic Support - System Profile](#)

This page lets you generate a system profile file, which includes device information such as system logs, system status, and configurations. This file can be used to assist troubleshooting.

Click the **GENERATE** button to generate and save a system profile file to your local host.

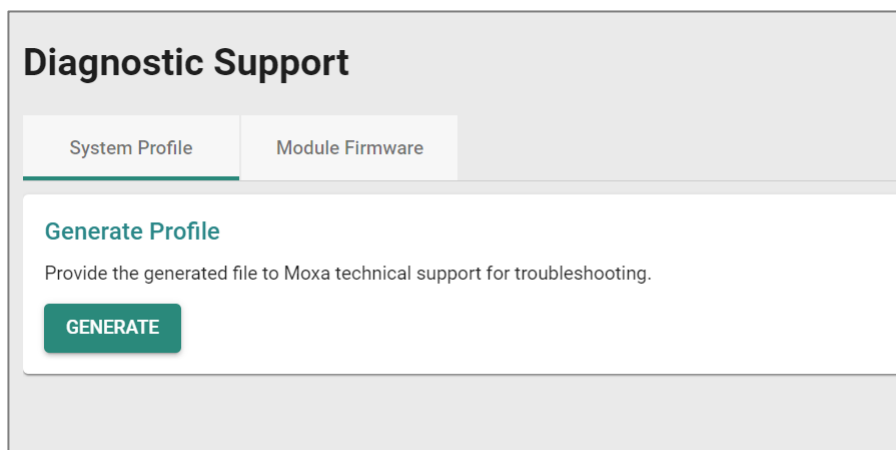

## Module Firmware

**Menu Path:** [Diagnostics > Tools > Diagnostic Support - Module Firmware](#)

This page lets you upgrade the firmware of the cellular module using a firmware file provided by Moxa Technical Support.



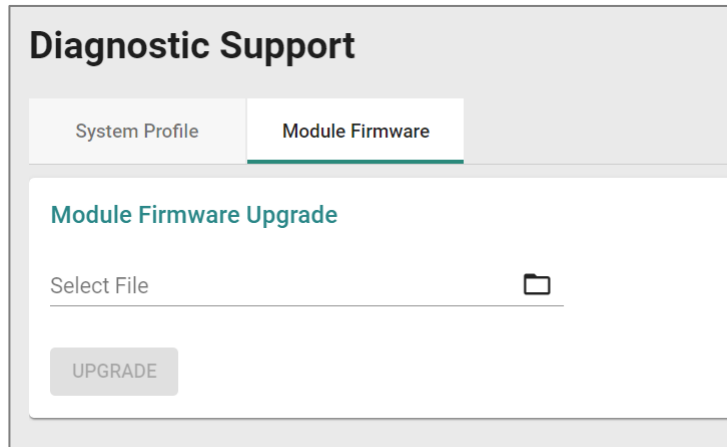

| UI Setting         | Description  | Valid Range | Default Value |
|--------------------|--|-------------|---------------|
| <b>Select File</b> | Select the firmware upgrade file from your local host, then click <b>UPGRADE</b> to upgrade the module's firmware. | N/A         | N/A           |

## NetFlow

**Menu Path:** [Diagnostics](#) > [Tools](#) > [NetFlow](#)

This page lets you create and edit NetFlows for your device.

## 🔒 Limitations

You can create up to 1 entry per interface.

## NetFlow Settings

NetFlow Settings

NetFlow \* Version \*  
Disabled V9

Collector Settings +

Active NetFlow Entry Timeout \* Inactivity Timeout \*  
300 15  
1 - 3600 sec. 1 - 3600 sec.

APPLY

+ Search

| <input type="checkbox"/>                | Status   | Interface | Mode     | Traffic Direction |
|---|----------|-----------|----------|-------------------|
| <input type="checkbox"/> <span>✎</span> | Disabled | WAN       | Basic    | Bidirectional     |
| <input type="checkbox"/> <span>✎</span> | Disabled | WAN       | Filtered | Bidirectional     |

Max. 4 Items per page: 50 1 - 2 of 2 |< < > >|

## NetFlow Settings

| UI Setting     | Description                              | Valid Range        | Default Value |
|----------------|--|--------------------|---------------|
| <b>NetFlow</b> | Enable or disable NetFlow.               | Enabled / Disabled | Disabled      |
| <b>Version</b> | Specify which version of NetFlow to use. | V5 / V9 / IPFIX    | V9            |

## Collector Settings

| UI Setting                           | Description                              | Valid Range                         | Default Value |
|--------------------------------------|--|-------------------------------------|---------------|
| <b>Collector 1 IP/<br/>Host Name</b> | Specify the collector 1 IP or host name. | Valid IP<br>address or host<br>name | N/A           |

| UI Setting                          | Description  | Valid Range                   | Default Value |
|-------------------------------------|--|-------------------------------|---------------|
| <b>Collector 1 Port</b>             | Specify the collector 1 port number.   | 1 to 65535                    | 9996          |
| <b>Collector 2 IP/ Host Name</b>    | Specify the collector 2 IP or host name.   | Valid IP address or host name | N/A           |
| <b>Collector 2 Port</b>             | Specify the collector 2 port number.   | 1 to 65535                    | 9996          |
| <b>Active NetFlow Entry Timeout</b> | Specify the active NetFlow entry timeout in seconds. This is the maximum duration a flow can remain "active" in the router's flow cache. | 1 to 3600 seconds             | 300           |
| <b>Inactivity Timeout</b>           | Specify the inactivity timeout in seconds. This is the maximum duration a flow can remain "inactive" without new packet matches.         | 1 to 3600 seconds             | 15            |

## Create NetFlow Entry

**Menu Path:** [Diagnostics](#) > [Tools](#) > [NetFlow](#)

Clicking the **Add (+)** icon on the **Diagnostics > Tools > NetFlow** page will open this dialog box. This dialog lets you create a new NetFlow entry. Click **CREATE** to save your changes and add the new NetFlow entry.

**Create NetFlow Entry**

Status \*

Interface \*

Traffic Direction \*

Mode \*

Sampling Rate \*  
  
0 - 65535

### Create NetFlow Entry

Status \*  
Disabled ▼

Interface \*  
WAN ▼

Traffic Direction \*  
Bidirectional ▼

Mode  
Filtered ▼

**Source IP Filter**

Source IP \*      Subnet Mask \*  
24 (255.255.255.0) ▼

Source Port \*      ⓘ  
0 - 65535

**Destination IP Filter**

Destination IP \*      Subnet Mask \*  
24 (255.255.255.0) ▼

Destination Port \*      ⓘ  
0 - 65535

**Protocol Filter**

Protocol \*  
All ▼

CANCEL    CREATE

| UI Setting               | Description  | Valid Range                      | Default Value |
|--------------------------|--|----------------------------------|---------------|
| <b>Status</b>            | Enable or disable the NetFlow entry.   | Enabled / Disabled               | Disabled      |
| <b>Interface</b>         | Specify the interface for the NetFlow entry.   | Drop-down list of interfaces     | WAN           |
| <b>Traffic Direction</b> | Select the traffic direction for the NetFlow entry.  | Bidirectional / Ingress / Egress | Bidirectional |
| <b>Mode</b>              | Select the mode for the NetFlow entry.<br><b>Basic:</b> This mode enables you to configure a NetFlow entry for your device.<br><b>Filtered:</b> This mode allows you to filter traffic by IP address or specific protocol. | Basic / Filtered                 | Basic         |

| UI Setting   | Description  | Valid Range       | Default Value |
|--|--|-------------------|---------------|
| <b>Sampling Rate</b><br>(Only when Mode is set as Basic)       | Specify the sampling rate of the NetFlow entry. 0 means the sampling rate will be set to 1.<br><br><div style="border: 1px solid #ccc; background-color: #f9f9f9; padding: 5px; margin-top: 10px;"> <p> <b>Note</b></p> <p>A lower number indicates more frequent sampling, with 1 representing sampling every packet, thus providing full visibility and accuracy. However, more intensive sampling may adversely affect performance.</p> </div> | 0 to 65535        | N/A           |
| <b>Source IP</b><br>(Only when Mode is set as Filtered)        | Specify the source IP.   | Valid IP address  | N/A           |
| <b>Subnet Mask</b><br>(Only when Mode is set as Filtered)      | Specify the subnet mask for the source IP.   | Valid subnet mask | N/A           |
| <b>Source Port</b><br>(Only when Mode is set as Filtered)      | Specify the port for the source IP. Setting this to 0 means all ports will be allowed.   | Valid port        | N/A           |
| <b>Destination IP</b><br>(Only when Mode is set as Filtered)   | Specify the destination IP.  | Valid IP address  | N/A           |
| <b>Subnet Mask</b><br>(Only when Mode is set as Filtered)      | Specify the subnet mask for the destination IP.  | Valid subnet mask | N/A           |
| <b>Destination Port</b><br>(Only when Mode is set as Filtered) | Specify the port for the destination IP. Setting this to 0 means all ports will be allowed.  | Valid port        | N/A           |
| <b>Protocol</b><br>(Only when Mode is set as Filtered)         | Select the protocol to filter.   | All / TCP / UDP   | N/A           |

## Delete NetFlow

### Menu Path: [Diagnostics](#) > [Tools](#) > [NetFlow](#)

You can delete a NetFlow by using the checkboxes to select the entries you want to delete, then clicking the **Delete** (  ) icon.

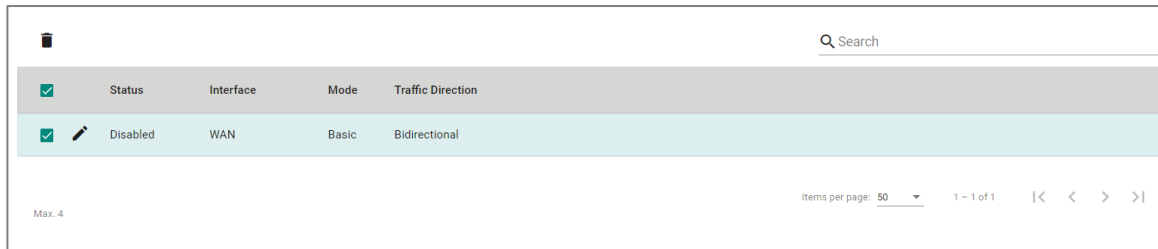

The screenshot shows a web interface for NetFlow configuration. At the top right, there is a search bar labeled "Search". Below it is a table with the following columns: "Status", "Interface", "Mode", and "Traffic Direction". The first row of the table is highlighted in light blue and contains the following data: a checked checkbox, a pencil icon, "Disabled", "WAN", "Basic", and "Bidirectional". Below the table, there is a pagination control showing "Items per page: 50" and "1 - 1 of 1".

| <input checked="" type="checkbox"/>   | Status   | Interface | Mode  | Traffic Direction |
|---|----------|-----------|-------|-------------------|
| <input checked="" type="checkbox"/>  | Disabled | WAN       | Basic | Bidirectional     |

Max. 4

Items per page: 50 1 - 1 of 1 |< < > >|

# Industrial Application

## Menu Path: Industrial Application

This menu settings area lets you configure settings related to specific industrial applications.

This settings area includes these sections:

- IEC 61375

### Note

Availability of this feature may vary depending on your product model and version.

## IEC 61375 Setting

### Menu Path: Industrial Application > IEC 61375

This section lets you configure IEC 61375 settings related to Ethernet Train Backbone Nodes (ETBN).

The IEC 61375 section includes these pages:

- Ethernet Train Backbone
- Communication Profile
- Operational Status

### Warning

Do not connect ETBNs through ETB ports before the ETBN has been configured.

If Turbo Ring V2 and ETBN are enabled at the same time, Turbo Ring V2 must be configured before ETBN for Turbo Ring V2 to work normally.

## Ethernet Train Backbone

### Menu Path: Industrial Application > IEC 61375 > Ethernet Train Backbone

This page lets you configure Ethernet Train Backbone settings for your device.

This page includes these tabs:

- [TTDP Settings](#)

- [Local ETBN Status](#)
- [ETB Status](#)
- [TCN Multicast Table](#)

## TTDP Settings

### Menu Path: Industrial Application > IEC 61375 > Ethernet Train Backbone - TTDP Settings

This page lets you set up Train Topology Discovery Protocol (TTDP) for your router. Click **APPLY** to save your changes.

#### ⚠ Warning

Enabling TTDP will overwrite settings for Port Trunk, VLAN, Interface, QoS, VRRP, and Turbo Ring V2.

#### ✍ Note

We recommend setting ETB ports to MDI mode, and using crossover cables for the interconnection of ETBNs.

### Ethernet Train Backbone

TTDP Settings
Local ETBN Status
ETB Status
TCN Multicast Table

TTDP Enable

Disabled ▼

ETB Backbone ID

0 (TCMS) ▼

| UI Setting             | Description                        | Valid Range   | Default Value |
|------------------------|------------------------------------|---|---------------|
| <b>TTDP Enable</b>     | Enable or Disable TTDP.            | Enabled / Disabled  | Disabled      |
| <b>ETB Backbone ID</b> | Specify an ETB backbone ID to use. | 0 (TCMS) / 1 (Multimedia) / 2 (Not specialized) / 3 (Not specialized) | 0 (TCMS)      |



## Local Consist

### Local Consist

Consist UUID  
0 ✕ ⓘ

8bit-4bit-4bit-4bit-12bit

ETBN(s) in Consist  
1 ▼ ECN(s) in Consist ▼

User can manually assign or generate random Consist UUID

| UI Setting                | Description  | Valid Range                          | Default Value |
|---------------------------|--|--------------------------------------|---------------|
| <b>Consist UUID</b>       | Shows the UUID of the local consist.<br><br>Consists with the same UUID will be considered to be the same consist. Therefore, the consist UUIDs for different consists should be unique.<br><br>You can manually assign a consist UUID, or you can generate a random one by clicking on the <b>X</b> button to erase the existing UUID, then clicking the <b>Refresh (↻)</b> icon to generate a random UUID. | Valid 8bit-4bit-4bit-4bit-12bit UUID | 0             |
| <b>ETBN(s) in Consist</b> | Specify the number of ETBNs in this consist.   | 1 to 32                              | 1             |
| <b>ECN(s) in Consist</b>  | Specify the number of ECNs in this consist.  | 1 to 32                              | N/A           |

## Local ETBN

### Local ETBN ⓘ

|                             |                          |                          |
|-----------------------------|--------------------------|--------------------------|
| Local ETBN Static ID<br>1 ▼ | Direction 1<br>Trunk 1 ▼ | ETB Port Speed<br>Auto ▼ |
| ETB Port VLAN ID<br>1000    | Direction 2<br>Trunk 2 ▼ | Port MDI/MDIX<br>Auto ▼  |

1-4094, 492 is reserved

| UI Setting                 | Description  | Valid Range  | Default Value |
|----------------------------|--|--|---------------|
| <b>Local ETB Static ID</b> | Specify the static ID of this ETBN within the consist.   | Drop-down list of ETBN Static IDs<br><br>(available options depend on the <b>ETBN(s) in Consist</b> setting in <a href="#">Industrial Application &gt; IEC 61375 &gt; Ethernet Train Backbone - TTDP Setting</a> ) | 1             |
| <b>Direction 1</b>         | Specify the consist direction for Direction 1.<br><br>The default setting is ports 1 and 2 will point towards direction 1, and ports 5 and 6 will point towards direction 2. | Trunk 1 / Trunk 2  | Trunk 1       |
| <b>ETB Port Speed</b>      | Specify the ETB port speed to use. When set to <b>Auto</b> , the port will use its default speed. For example, a 1G port set to <b>Auto</b> will use 1G for its port speed.  | Auto / 1G / 100M   | Auto          |
| <b>ETB Port VLAN ID</b>    | Specify the VLAN ID for the ETB ports.<br><br>We recommend using the same VLAN ID for all ETBNs on each train.   | 1-4094, 492 is reserved  | 1000          |
| <b>Direction 2</b>         | Specify the consist direction for Direction 2.<br><br>The default setting is ports 1 and 2 will be point towards direction 1, and ports 5 and 6 will point to direction 2.   | Trunk 1 / Trunk 2  | Trunk 2       |
| <b>Port MDI/MDIX</b>       | Specify the ETB port interface type.   | Auto / MDI / MDIX  | Auto          |

## Consist Network

### 🔑 Limitations

You can create up to 32 ECN entries, depending on what the ECN(s) in Consist setting is set to. Refer to TTDP Settings for more information.

**Consist Network**

+
Search

|                          | Static ID | ECN to ETBN | ECN Port VLAN ID | Interface IP address | ECN Ports |
|--------------------------|-----------|-------------|------------------|----------------------|-----------|
| <input type="checkbox"/> | 1         | 1           | 1001             | 10.1.0.1             | 3,4,7,8   |

Max. 1
Items per page: 5
1 - 1 of 1

APPLY

| UI Setting                  | Description  |
|-----------------------------|--|
| <b>Static ID</b>            | Shows the static ID of this ETBN within the consist.             |
| <b>ECN to ETBN</b>          | Shows which ETBN in the consist will be connected to by the ECN. |
| <b>ECN Port VLAN ID</b>     | Shows the VLAN ID of the ECN Port.                               |
| <b>Interface IP address</b> | Shows the interface IP address for the ECN.                      |
| <b>ECN Ports</b>            | Shows the ports which the selected ECN will connect to.          |

### Add ECN

#### Menu Path: Industrial Application > IEC 61375 > Ethernet Train Backbone - TTDP Settings

Clicking the **Add (+)** icon on the **Industrial Application > IEC 61375 > Ethernet Train Backbone - TTDP Settings** page will open this dialog box. This dialog lets you create a new ECN entry. Click **CREATE** to save your changes and add the new entry.

### Add ECN

ECN to ETBN ▼

---

ECN Port VLAN ID

---

Default 1000 + static ID

ECN interface IP address i

---

ECN Ports ▼ i

---

CANCEL
APPLY

| UI Setting                      | Description   | Valid Range   | Default Value |
|---------------------------------|---|---|---------------|
| <b>ECN to ETBN</b>              | Specify which ETBN in the consist will be connected by the ECN.   | Drop-down list of ETBN Static IDs<br><br>(depends on the <b>ETBN(s) in Consist</b> setting in <a href="#">Industrial Application &gt; IEC 61375 &gt; Ethernet Train Backbone - TTDP Setting</a> ) | N/A           |
| <b>ECN port VLAN ID</b>         | Specify the VLAN ID of the ECN port. Specifying a VLAN ID is required if the selected ECN is connected to this ETBN.  | Valid VLAN ID   | N/A           |
|                                 | <p> <b>Note</b></p> <p>We recommend setting the ECN Port VLAN ID value to 1000 + (Local ETBN Static ID) for cases where each ETBN corresponds to its own ECN.</p> |   |               |
| <b>ECN interface IP address</b> | Set the interface IP address for the ECN.   | Valid IP address  | N/A           |

| UI Setting       | Description  | Valid Range             | Default Value |
|------------------|--|-------------------------|---------------|
| <b>ECN Ports</b> | Specify which ports the selected ECN will connect to. Specifying ports is required if the selected ECN is connected to this ETBN.<br><br>Available ports will vary depending on the product model. The port used by the ETBN cannot be selected. | Drop-down list of ports | N/A           |

## Edit ECN

### Menu Path: Industrial Application > IEC 61375 > Ethernet Train Backbone - TTDP Settings

Clicking the **Edit (✎)** icon for an entry on the **Industrial Application > IEC 61375 > Ethernet Train Backbone - TTDP Settings** page will open this dialog box. This dialog lets you edit an existing ECN entry. Click **APPLY** to save your changes.

#### Edit ECN 1

ECN to ETBN  
ETB 2

ECN Port VLAN ID  
1

Default 1000 + static ID  
ECN interface IP address  
1.1.1.1

ECN Ports  
port 2,3

CANCEL APPLY

| UI Setting         | Description   | Valid Range   | Default Value |
|--------------------|---|---|---------------|
| <b>ECN to ETBN</b> | Specify which ETBN in the consist will be connected by the ECN. | Drop-down list of ETBN Static IDs<br><br>(depends on the <b>ETBN(s) in Consist</b> setting in <a href="#">Industrial Application &gt; IEC 61375 &gt; Ethernet Train Backbone - TTDP Setting</a> ) | N/A           |

| UI Setting                      | Description  | Valid Range             | Default Value |
|---------------------------------|--|-------------------------|---------------|
| <b>ECN port VLAN ID</b>         | Specify the VLAN ID of the ECN port. Specifying a VLAN ID is required if the selected ECN is connected to this ETBN.<br><br><div style="border: 1px solid #ccc; background-color: #f9f9f9; padding: 5px; margin: 10px 0;"> <p><b>Note</b></p> <p>We recommend setting the ECN Port VLAN ID value to 1000 + (Local ETBN Static ID) for cases where each ETBN corresponds to its own ECN.</p> </div> | Valid VLAN ID           | N/A           |
| <b>ECN interface IP address</b> | Set the interface IP address for the ECN.  | Valid IP address        | N/A           |
| <b>ECN Ports</b>                | Specify which ports the selected ECN will connect to. Specifying ports is required if the selected ECN is connected to this ETBN.<br><br>Available ports will vary depending on the product model. The port used by the ETBN cannot be selected.   | Drop-down list of ports | N/A           |

## Delete ECN

### Menu Path: Industrial Application > IEC 61375 > Ethernet Train Backbone - TTDP Settings

You can delete an ECN entry by using the checkboxes to select the entries you want to delete, then clicking the **Delete (🗑)** icon.

| Static ID                           | ECN to ETBN | ECN Port VLAN ID | Interface IP address | ECN Ports |
|-------------------------------------|-------------|------------------|----------------------|-----------|
| <input checked="" type="checkbox"/> | 1           | 1                | 1.1.1.1              | 1         |

## Local ETBN Status

### Menu Path: Industrial Application > IEC 61375 > Ethernet Train Backbone - Local ETBN Status

This page lets you see the status of your local ETBN.

## Local ETBN Status

### Ethernet Train Backbone

TTDP Settings
Local ETBN Status
ETB Status
TCN Multicast Table

#### Local ETBN Status 2023/09/20 17:41:13

|                    |                      |                      |
|--------------------|----------------------|----------------------|
| ETBN State         | etbnInhibition       | InaugInhibition      |
| <b>Inaugurated</b> | <b>Not Inhibited</b> | <b>Not Inhibited</b> |
| remoteInhibition   | Lengthen             | Shorten              |
| <b>Undefined</b>   | <b>False</b>         | <b>False</b>         |

| UI Setting              | Description   |
|-------------------------|---|
| <b>ETBN State</b>       | Shows the inauguration status of the ETBN state machine.  |
| <b>etbnInhibition</b>   | Shows information about any inhibition requests from this node.   |
| <b>inaugInhibition</b>  | Shows flags that are the result of the <b>etbnInhibition</b> field of topology frames received from all other ETBNs and the CN local value.<br><br>During power-up, <b>inaugInhibition</b> is meaningless until the ETBN reaches the <b>INAUGURATED</b> state at least once. The value at startup is set to <b>False</b> to allow for the first inauguration.   |
| <b>remoteInhibition</b> | This shows whether the remote composition is allowed to inaugurate (only set by end nodes) when lengthening takes place.<br><br>The initial value should be set as <b>UNDEFINED</b> , which means it shall not be taken into account.   |
| <b>Lengthen</b>         | Shows the lengthen status due to a lengthening by an inaugurated composition (can be set by any node), such as the appearance of a new consist.<br><br>Set to <b>TRUE</b> if a node detects a new node with a consist UUID different from those contained in the Train Network Directory.   |
| <b>Shorten</b>          | Shows the shorten status due to a shortening, which is the loss of at least one consist at the end of a train (can be set by any node).<br><br>Set to <b>TRUE</b> if a node detects at least one consist is lost at the end of the train according to the Train Network Directory.<br><br>It resets to <b>FALSE</b> ("stable") by default if the consist appears again or the Train Network Directory is updated. |

## ETBN Line Status

| ETBN Line Status                    |                     |                     |                     |                     |
|-------------------------------------|---------------------|---------------------|---------------------|---------------------|
| <input type="text" value="Search"/> |                     |                     |                     |                     |
| Line                                | Line Status (DIR 1) | Line Status (DIR 2) | Hello Frame (DIR 1) | Hello Frame (DIR 2) |
| A                                   | Off                 | On                  | -                   | Valid               |
| B                                   | Off                 | On                  | -                   | Valid               |

Items per page:     1 – 2 of 2   

| UI Setting                 | Description   |
|----------------------------|---|
| <b>Line</b>                | Shows which ETBN line (A or B) the entry is for.  |
| <b>Line Status (DIR 1)</b> | Shows the link status of the line for Direction 1 of the ETBN line.                                     |
| <b>Line Status (DIR 2)</b> | Shows the link status of the line for Direction 2 of the ETBN line.                                     |
| <b>Hello Frame (DIR 1)</b> | Shows whether the neighbor Ethernet port in Direction 1 for the ETBN is up, and will send Hello Frames. |
| <b>Hello Frame (DIR 2)</b> | Shows whether the neighbor Ethernet port in Direction 2 for the ETBN is up, and will send Hello Frames. |

## Local ETBN Redundant Role

| Local ETBN Redundant Role           |                           |
|-------------------------------------|---------------------------|
| <input type="text" value="Search"/> |                           |
| CN ID                               | Local ETBN Redundant Role |
| 1                                   | Not Redundant             |

Items per page:     1 – 1 of 1



| UI Setting                       | Description   |
|----------------------------------|---|
| <b>CN ID</b>                     | Shows the ID of the consist node, which is statically defined.                        |
| <b>Local ETBN Redundant Role</b> | Shows which CN is connected to the Local ETBN and whether the CN has ETBN redundancy. |

## ETB Status

**Menu Path: Industrial Application > IEC 61375 > Ethernet Train Backbone - ETB Status**

This page lets you see the status of your ETB.

### ETB Status

### Ethernet Train Backbone

TTDP Settings
Local ETBN Status
ETB Status
TCN Multicast Table

#### ETB Status

2023/09/20 17:49:10

|                  |          |         |
|------------------|----------|---------|
| remoteInhibition | Lengthen | Shorten |
| Undefined        | False    | False   |

| UI Setting              | Description  |
|-------------------------|--|
| <b>remoteInhibition</b> | <p>This shows whether the remote composition is allowed to inaugurate (only set by end nodes) when lengthening takes place.</p> <p>The initial value should be set as <b>UNDEFINED</b>, which means it shall not be taken into account.</p>  |
| <b>Lengthen</b>         | <p>Shows the lengthen status due to a lengthening by an inaugurated composition (can be set by any node), such as the appearance of a new consist.</p> <p>Set to <b>TRUE</b> if a node detects a new node with a consist UUID different from those contained in the Train Network Directory.</p> |

| UI Setting     | Description  |
|----------------|--|
| <b>Shorten</b> | <p>Shows the shorten status due to a shortening, which is the loss of at least one consist at the end of a train (can be set by any node).</p> <p>Set to <b>TRUE</b> if a node detects at least one consist is lost at the end of the train according to the Train Network Directory.</p> <p>It resets to <b>FALSE</b> ("stable") by default if the consist appears again or the Train Network Directory is updated.</p> |

## Connectivity Table

| Connectivity Table                  |                |                   |
|-------------------------------------|----------------|-------------------|
| ConnTableValid                      | ConnTableCrc32 |                   |
| True                                | 8411CB11       |                   |
| <input type="text" value="Search"/> |                |                   |
| Index                               | Orientation    | Mac Address       |
| 1                                   | Direct         | 00:90:E8:03:04:05 |
| 2                                   | Direct         | 00:90:E8:49:08:A1 |
| 3                                   | Inverse        | 00:90:E8:49:16:F8 |
| 4                                   | Inverse        | 00:90:E8:49:08:F2 |
| Items per page: 5                   |                | 1 - 4 of 4        |

| UI Setting            | Description  |
|-----------------------|--|
| <b>ConnTableValid</b> | Shows whether the Physical Topology is shared by all ETBNs (same connectivity table CRC is used for all ETBNs).                    |
| <b>ConnTableCrc32</b> | Shows the CRC32 value of the internal Connectivity Table.  |
| <b>Index</b>          | Shows the Index number of a node. The number of entries will vary between models and depending on how many ports have been set up. |
| <b>Orientation</b>    | Shows information about the orientation of the node with respect to the ETB reference direction.                                   |
| <b>MAC address</b>    | Shows the MAC address of the node.   |

## Train Network Directory

### Train Network Directory

EtbTopoCntValid  
True

EtbTopoCnt      Memorized EtbTopoCnt  
BEDE0458      BEDE0458

| Index | CstUUID                              | CN ID | Subnet ID (Train Subnet) | ETBN ID | CstOrientation |
|-------|--------------------------------------|-------|--------------------------|---------|----------------|
| 1     | 00000000-0000-0000-0000-000000000002 | 1     | 10.128.64.0/18           | 1       | Direct         |
| 2     | 00000000-0000-0000-0000-000000000003 | 1     | 10.128.128.0/18          | 2       | Direct         |
| 3     | 00000000-0000-0000-0000-000000000004 | 1     | 10.128.192.0/18          | 3       | Inverse        |
| 4     | 00000000-0000-0000-0000-000000000004 | 1     | 10.128.192.0/18          | 4       | Inverse        |

Items per page: 5      1 - 4 of 4      << < > >>

| UI Setting                  | Description  |
|-----------------------------|--|
| <b>EtbTopoCntValid</b>      | Shows whether the Logical Topology is shared by all ETBNs (same Train Network Directory CRC is used for all ETBNs).  |
| <b>etbTopoCnt</b>           | Shows the CRC32 checksum of the internal Train Network Directory.  |
| <b>Memorized etbTopoCnt</b> | While the ETB node is in state INAUGURATED, etbTopoCnt field in TTDP TOPOLOGY frame is fixed to the memorized CRC of the Train Network Directory. The Memorized etbTopoCnt and etbTopoCnt may be different when "inaugInhibition" is inhibited |
| <b>Index</b>                | Shows the Index number of a CN.  |
| <b>CstUUID</b>              | Shows the Consist Universal Unique ID (refer to IETF RFC 4122) of the CN.  |
| <b>CN Id</b>                | Shows the ID of the CN, which is statically defined.   |
| <b>Subnet Id</b>            | Shows the subnet ID of the CN on the ETB.  |
| <b>Train Subnet</b>         | Shows the Train Subnet IP of the CN.   |
| <b>ETBN Id</b>              | Shows the ID of the ETBN on the ETB.   |

| UI Setting            | Description   |
|-----------------------|---|
| <b>CstOrientation</b> | Shows the orientation of the consist in relation to the direction of the train. |

## TCN Multicast Table

**Menu Path: Industrial Application > IEC 61375 > Ethernet Train Backbone - TCN Multicast Table**

This page lets you see the status of your TCN multicast entries.

### Ethernet Train Backbone

TTDP Settings
Local ETBN Status
ETB Status
TCN Multicast Table

🔄 2023/09/20 17:51:38
🔍 Search

| Index | TCN Group Address | Inbound Interface | Outbound Interface(s) |
|-------|-------------------|-------------------|-----------------------|
| 1     | 239.192.0.0       | ETB               | ECN1                  |
| 2     | 239.192.0.0       | ECN1              | ETB                   |
| 3     | 239.192.0.1       | ETB               | ECN1                  |
| 4     | 239.192.0.1       | ECN1              | ETB                   |
| 5     | 239.192.0.2       | ECN1              | ETB                   |

Items per page: 5
1 – 5 of 15
|< < > >|

| UI Setting                   | Description                                   |
|------------------------------|---|
| <b>Index</b>                 | Shows the index of the TCN entry.             |
| <b>TCN Group Address</b>     | Shows the group address for the TCN.          |
| <b>Inbound Interface</b>     | Shows the ETBN inbound interface of the TCN.  |
| <b>Outbound Interface(s)</b> | Shows the ETBN outbound interface of the TCN. |

# Communication Profile

**Menu Path: Industrial Application > IEC 61375 > Communication Profile**

This section lets you set up communication profiles for your device.

This section includes these pages:

- ECSP Settings
- SDTv2 Settings
- ECSP Status
- SDTv2 Status

## ECSP Settings

**Menu Path: Industrial Application > IEC 61375 > Communication Profile > ECSP Settings**

This page lets you back up or restore the local consist info file and the TRDP configuration file.

### Local Consist Info

Click **BACKUP** to back up the current local consist info file to your local host. To restore, select a local consist info file from your local host, then click **RESTORE**.

**Note**

You cannot back up the local consist info file if one hasn't been previously loaded onto your router.

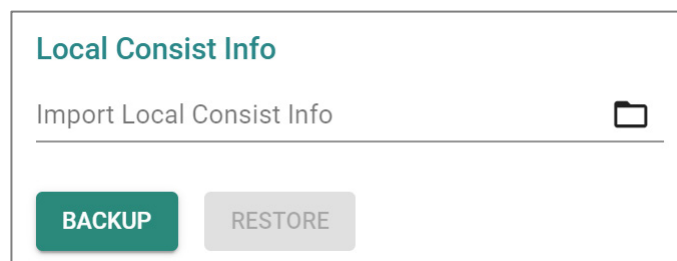

| UI Setting                       | Description   | Valid Range | Default Value |
|----------------------------------|---|-------------|---------------|
| <b>Import Local Consist Info</b> | Select a local consist info file to restore from by clicking on the <b>Folder</b> (📁) icon, selecting the file to restore from, then clicking <b>RESTORE</b> .<br><br>Refer to <a href="#">Structure and Syntax of Consist Info Configuration Files</a> for more information. | Local file  | N/A           |

## TRDP Config

Click **BACKUP** to back up the current TRDP configuration to your local host. To restore, select a TRDP configuration file from your local host, then click **RESTORE**.

| UI Setting                | Description  | Valid Range | Default Value |
|---------------------------|--|-------------|---------------|
| <b>Import TRDP Config</b> | Select a local TRDP configuration file to restore from by clicking on the <b>Folder</b> (📁) icon, selecting the file to restore from, then clicking <b>RESTORE</b> . | Local file  | N/A           |

## SDTv2 Settings

**Menu Path: Industrial Application > IEC 61375 > Communication Profile > SDTv2 Settings**

This page lets you enable or disable Safe Data Transmission protocol (SDTv2) telegrams.

## Communication profile

ECSP Settings
SDTv2 Settings
ECSP Status
SDTv2 Status

|                          | Status | Telegram     | ComID |
|--------------------------|--------|--------------|-------|
| <input type="checkbox"/> | Enable | ETBCTRL      | 1     |
| <input type="checkbox"/> | Enable | TTDB Status  | 100   |
| <input type="checkbox"/> | Enable | ECSP Control | 120   |
| <input type="checkbox"/> | Enable | ECSP Status  | 121   |

Items per page: 5
1 - 4 of 4
|< < > >|

| UI Setting      | Description                            |
|-----------------|--|
| <b>Status</b>   | Shows whether the telegram is enabled. |
| <b>Telegram</b> | Shows the name of the telegram.        |
| <b>ComID</b>    | Shows the ComID of the telegram.       |

### Edit Status

**Menu Path: Industrial Application > IEC 61375 > Communication Profile > SDTv2 Settings**

Clicking the **Edit (✎)** icon after selecting entries on the **Industrial Application > IEC 61375 > Communication Profile > SDTv2 Settings** page will open this dialog box. This dialog lets you enable or disable the selected entries. Click **APPLY** to save your changes.

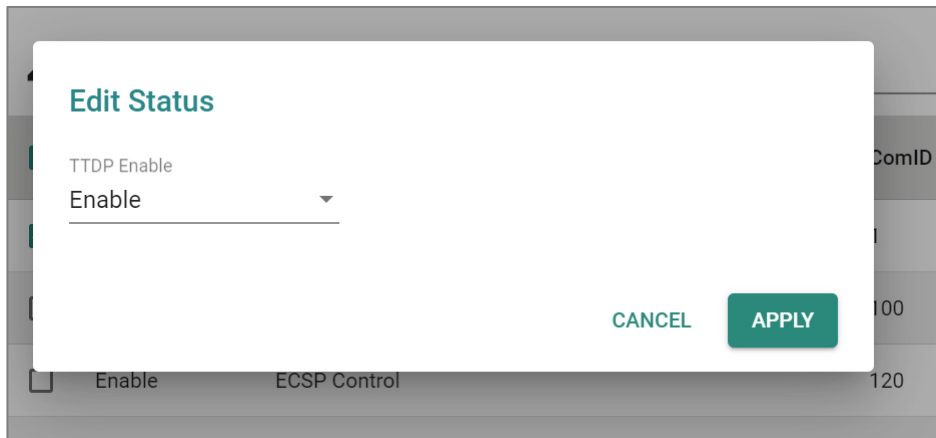

| UI Setting         | Description                               | Valid Range        | Default Value |
|--------------------|---|--------------------|---------------|
| <b>TTDP Enable</b> | Enable or disable the selected telegrams. | Enabled / Disabled | Enabled       |

## ECSP Status

**Menu Path: Industrial Application > IEC 61375 > Communication Profile > ECSP Status**

This page lets you see the current status of the ECSP and the state machines.

## ECSP Status

### Communication profile

ECSP Settings
SDTv2 Settings
ECSP Status
SDTv2 Status

#### ECSP Status 2023/09/20 17:54:40

|   |                               |
|---|-------------------------------|
| ETB Control Service<br><b>Active (NotRedundant)</b> | ECSC Status<br><b>Offline</b> |
|---|-------------------------------|



| UI Setting                 | Description   |
|----------------------------|---|
| <b>ETB Control Service</b> | Shows whether the ETB Control Service Provider (ECSP) is providing ETB Control Service or not, which may be impacted by the VRRP role.<br><br><b>Active:</b> <ul style="list-style-type: none"> <li>Local ECSP (ETBN) is VRRP master, and has found an ECSC</li> <li>Local ECSP (ETBN) has no redundancy</li> </ul> <b>Not Active:</b> <ul style="list-style-type: none"> <li>Local ECSP (ETBN) is the VRRP backup</li> </ul> |
| <b>ECSC Status</b>         | Shows whether an ETB Control Service Client (ECSC) is communicating with the ECSP.<br><br><b>Online:</b> The ECSP received a ECSP Control Telegram from an ECSC and is currently connected.<br><br><b>Offline:</b> An ECSC previously connected to the ECSP, but is not currently connected.<br><br><b>NotExist:</b> The ECSP has not connected to an ECSC yet.   |

## State Machine List

The State Machine List includes the 5 state machines that have been defined in IEC 61375-2-3.

| Q Search                    |                |
|-----------------------------|----------------|
| State Machine               | State          |
| Leading                     | WaitForLeadReq |
| Confirmation/Correction     | CompUnknown    |
| ETB Control                 | EtbCtrlSetUp   |
| Train Directory             | TrnDirSetup    |
| Operational Train Directory | Shared         |

Items per page: 5 1 - 5 of 5 < >

| UI Settings           | Description                          |
|-----------------------|--------------------------------------|
| <b>State Machines</b> | Shows the name of the state machine. |

| UI Settings  | Description  |
|--------------|--|
| <b>State</b> | Shows the current state of the state machine. <ul style="list-style-type: none"> <li>• <b>Leading</b><br/>Init / WaitForLeadReq / WaitForAccept / WaitForLead / WaitForLed / IsLeading / IsLed</li> <li>• <b>Confirmation / Correction</b><br/>Init / CompClear / CompUnknown / CompSet / CompStored / CompReset</li> <li>• <b>ETB Control</b><br/>Init / WaitForEtbCtrl / EtbCtrlSetUp</li> <li>• <b>Train Directory</b><br/>Init / WaitForEtbInaug / WaitForCstInfo / TrnDirSetUp</li> <li>• <b>Operational Train Directory</b><br/>Init / Invalid / Valid / Shared</li> </ul> |

## SDTv2 Status

**Menu Path: Industrial Application > IEC 61375 > Communication Profile > SDTv2 Status**

This page lets you see the SDSRC and SDSINK information for SDTv2 telegrams.

### ECSP SDSRC

This table shows the Safe Data Source (SDSRC) used for sending vital data packets (VDPs) in SDTv2 telegrams to a Safe Data Sink (SDSINK).

| ECSP SDSRC                          |       |                         | 2023/09/20 17:58:46  |
|-------------------------------------|-------|-------------------------|---|
| <input type="text" value="Search"/> |       |                         |   |
| Telegram                            | ComID | Source Identifier (SID) |   |
| ETBCTRL                             | 1     | 0x9d9e7b4f              |   |
| TTDB Status                         | 100   | 0xb163bea5              |   |
| ECSP Status                         | 121   | 0x43206c09              |   |

Items per page: 5 ▼ 1 - 3 of 3 |< < > >|

| UI Setting                     | Description  |
|--------------------------------|--|
| <b>Telegram</b>                | Shows the name of the telegram.  |
| <b>ComID</b>                   | Shows the ComID for the telegram.  |
| <b>Source Identifier (SID)</b> | Shows the SID for the telegram, which is an unsigned32 value computed as an SC-32 signature of the data structure. |

## ECSP SDSINK

This table shows the Safe Data Sink (SDSINK) used to receive vital data packets (VDPs) in SDTv2 telegrams from a Safe Data Source (SDSRC).

**ECSP SDSINK**

🔍 Search

| Telegram | ComID | State | Expected Source Identifier (SID) |
|----------|-------|-------|----------------------------------|
| ---      | ---   | ---   | ---                              |

Items per page: 5 ▼ 1 - 1 of 1 |< < > >|

| UI Setting                              | Description  |
|---|--|
| <b>Telegram</b>                         | Shows the name of the telegram.  |
| <b>ComID</b>                            | Shows the ComID for the telegram.  |
| <b>State</b>                            | Shows the state of the telegram.<br><b>RegularCommunication:</b> In this state, transmitted VDPs cannot be considered to be safe.<br><b>State SafeCommunication:</b> In this state, transmitted VDPs can be considered to be safe. |
| <b>Expected Source Identifier (SID)</b> | Shows the SID of the expected SDSRC to receive VDPs from. This information is retrieved from the Train Topology Database (TTDB).   |

# Operational Status

**Menu Path: Industrial Application > IEC 61375 > Operational Status**

This page lets you know the Status of your IEC 61375 related operational settings.

This page includes these tabs:

- Consist Info
- Train Directory
- Operational Train Directory
- TCN-URI Table

## Consist Info

**Menu Path: Industrial Application > IEC 61375 > Operational Status - Consist Info**

This page lets you see information about the current consist.

### Consist Info

### Operational Status

- Consist Info
- Train Directory
- Operational Train Directory
- TCN-URI Table

---

#### Consist Info

2023/09/20 18:01:34

|                 |               |
|-----------------|---------------|
| Consist Class   | Consist Type  |
| <b>consist</b>  | <b>test</b>   |
| Consist ID      | Consist Owner |
| <b>consist2</b> | <b>TCMS</b>   |

Consist UUID  
00000000-0000-0000-0000-000000000002

| UI Setting           | Description                             |
|----------------------|---|
| <b>Consist Class</b> | Shows the CSTINFO class of the consist. |
| <b>Consist Type</b>  | Shows the type of the consist.          |

| UI Setting           | Description                     |
|----------------------|---------------------------------|
| <b>Consist ID</b>    | Shows the ID of the consist.    |
| <b>Consist Owner</b> | Shows the owner of the consist. |
| <b>Consist UUID</b>  | Shows the UUID of the consist.  |

## ETB List

**ETB List**

🔍 Search

| ETB ID | Consist Network Count |
|--------|-----------------------|
| 0      | 1                     |

Items per page: 5 ▼ 1 - 1 of 1 |< < > >|

| UI Setting                   | Description   |
|------------------------------|---|
| <b>ETB ID</b>                | Shows the ID of the ETB.<br><b>0:</b> ETB0 (operational network)<br><b>1:</b> ETB1 (multimedia network)<br><b>2:</b> ETB2 (other network)<br><b>3:</b> ETB3 (other network) |
| <b>Consist Network Count</b> | Shows how many CNs are in the consists connected to the ETB.  |

## Vehicle List

### Vehicle List

Search

| Vehicle ID | Vehicle Type    | Vehicle Orientation | Consist Vehicle Number | Traction |
|------------|-----------------|---------------------|------------------------|----------|
| veh2       | intercity_train | same                | 1                      | true     |

Items per page: 5 1 - 1 of 1

### UI Setting

### Description

#### Vehicle ID

Shows the ID of the vehicle.

#### Vehicle type

Shows the type of the vehicle.

#### Vehicle Orientation

Shows the orientation of the vehicle.

**same:** Indicates that vehicle has the same direction with respect to the consist direction.

**inverse:** Indicates that the vehicle is in the opposite direction with respect to the consist direction.

#### Consist Vehicle Number

Shows the index of the vehicle within the consist.

#### Traction

Shows whether the vehicle has traction.

## Function List

### Function List

Search

| Name    | Function ID | Group | Consist Vehicle Number | ETB ID | Consist Network ID |
|---------|-------------|-------|------------------------|--------|--------------------|
| devCam1 | 11          | false | 1                      | 0      | 1                  |
| devECSC | 201         | false | 1                      | 0      | 1                  |
| grpDoor | 20          | true  | 1                      | 0      | 0                  |

Items per page: 5 1 - 3 of 3

| UI Setting                    | Description   |
|-------------------------------|---|
| <b>Name</b>                   | Shows the name of the device/functional group.  |
| <b>Function ID</b>            | Shows the ID of the device/functional group.  |
| <b>Group</b>                  | Shows whether this is a functional group.   |
| <b>Consist Vehicle Number</b> | Shows the index of the vehicle Sequence number of the vehicle within the consist the device/functional group belongs to.  |
| <b>ETB ID</b>                 | Shows the ID of the ETB the device/functional group is on.<br><b>0:</b> ETB0 (operational network)<br><b>1:</b> ETB1 (multimedia network)<br><b>2:</b> ETB2 (other network)<br><b>3:</b> ETB3 (other network) |
| <b>Consist Network ID</b>     | Shows the ID of the consist network the device/functional group is in.  |

## Train Directory

**Menu Path: Industrial Application > IEC 61375 > Operational Status - Train Directory**

This page shows information about the train and the consists in it.

### Train Directory

### Operational Status

Consist Info
Train Directory
Operational Train Directory
TCN-URI Table

#### Train Directory

2023/09/20 18:03:11

|                            |                          |
|----------------------------|--------------------------|
| ETB ID                     | Train Topography Counter |
| ETB0 (operational network) | 0x1BD3CBE9               |

| UI Setting                      | Description   |
|---------------------------------|---|
| <b>ETB ID</b>                   | Shows the ID of the ETB.<br><b>0:</b> ETB0 (operational network)<br><b>1:</b> ETB1 (multimedia network)<br><b>2:</b> ETB2 (other network)<br><b>3:</b> ETB3 (other network) |
| <b>Train Topography Counter</b> | Shows a counter used to check whether all the ECSPs in the train have the same train direction during ECSP negotiation.   |

## Consist List

| Consist List                         |                     |                |                            |
|--------------------------------------|---------------------|----------------|----------------------------|
| <input type="text" value="Search"/>  |                     |                |                            |
| Consist UUID                         | Consist Orientation | Consist Number | Consist Topography Counter |
| 00000000-0000-0000-0000-000000000002 | same                | 1              | 0x82088A3A                 |
| 00000000-0000-0000-0000-000000000003 | same                | 2              | 0x5841F1BA                 |
| 00000000-0000-0000-0000-000000000004 | inverse             | 3              | 0x424A9E0F                 |

Items per page: 5 1 - 3 of 3 |< < > >|

| UI Setting                      | Description  |
|---------------------------------|--|
| <b>Consist UUID</b>             | Shows the UUID of the consist.   |
| <b>Consist Orientation</b>      | Shows the orientation of the consist.<br><b>same:</b> Indicates that consist has the same direction with respect to the train direction.<br><b>inverse:</b> Indicates that the consist is in the opposite direction with respect to the train direction. |
| <b>Consist Number</b>           | Shows the index of the consist within the train.   |
| <b>Consist Topology Counter</b> | Shows the consist topography counter provided with the CSTINFO.  |



## Operational Train Directory

**Menu Path: Industrial Application > IEC 61375 > Operational Status - Operational Train Directory**

This page shows information about the operational train, consists, and vehicles.

### Operational Train Directory

#### Operational Status

|              |                 |                                    |               |
|--------------|-----------------|------------------------------------|---------------|
| Consist Info | Train Directory | <b>Operational Train Directory</b> | TCN-URI Table |
|--------------|-----------------|------------------------------------|---------------|

**Operational Train Directory** 2023/09/20 18:08:55 

ETB ID  
ETB0 (operational network)

|                                       |  |
|---------------------------------------|--|
| Operational Train Orientation<br>same | Operational Train Topography Counter<br>0xA61014B3 |
|---------------------------------------|--|

| UI Setting                                  | Description  |
|---|--|
| <b>ETB ID</b>                               | Shows the ID of the ETB.<br><b>0:</b> ETB0 (operational network)<br><b>1:</b> ETB1 (multimedia network)<br><b>2:</b> ETB2 (other network)<br><b>3:</b> ETB3 (other network)  |
| <b>Operational Train Orientation</b>        | Shows the orientation of the vehicle.<br><b>same:</b> Indicates that operational train has the same direction with respect to the train direction.<br><b>inverse:</b> Indicates that the operational train is in the opposite direction with respect to the train direction.<br><b>unknown:</b> The direction of the operational train is unknown. |
| <b>Operational Train Topography Counter</b> | Shows the computed operational train topography counter, which is automatically configured.  |

## Operational Consist List

| Operational Consist List              |                            |                |                                 |
|---------------------------------------|----------------------------|----------------|---------------------------------|
| <input type="text" value="Search"/>   |                            |                |                                 |
| Consist UUID                          | Operational Consist Number | Consist Number | Operational Consist Orientation |
| 00000000-0000-0000-0000-0000000000021 | 1                          |                | same                            |
| 00000000-0000-0000-0000-0000000000032 | 2                          |                | same                            |
| 00000000-0000-0000-0000-0000000000043 | 3                          |                | inverse                         |

Items per page: 5    1 – 3 of 3    << < > >>

| UI Setting                             | Description  |
|--|--|
| <b>Consist UUID</b>                    | Shows the UUID of the operational consist.   |
| <b>Operational Consist Number</b>      | Shows the index of the operational consist, which is automatically configured.   |
| <b>Consist Number</b>                  | Shows the index of the consist that the operational consist is in.   |
| <b>Operational Consist Orientation</b> | Shows the orientation of the operational consist.<br><b>same:</b> Indicates that the operational consist has the same direction with respect to the train direction.<br><b>inverse:</b> Indicates that the operational consist is in the opposite direction with respect to the train direction.<br><b>unknown:</b> The direction of the operational consist is unknown. |

## Operational Vehicle List

| Operational Vehicle List            |                     |       |                |                            |                      |                            |
|-------------------------------------|---------------------|-------|----------------|----------------------------|----------------------|----------------------------|
| <input type="text" value="Search"/> |                     |       |                |                            |                      |                            |
| Vehicle ID                          | Vehicle Orientation | Lead  | Lead Direction | Operational Vehicle Number | Train Vehicle Number | Operational Consist Number |
| veh2                                | same                | false | Not relevant   | 1                          | 1                    | 1                          |
| veh3                                | same                | false | Not relevant   | 2                          | 2                    | 2                          |
| veh4                                | inverse             | false | Not relevant   | 3                          | 3                    | 3                          |

Items per page:  1 – 3 of 3

| UI Setting                        | Description   |
|-----------------------------------|---|
| <b>Vehicle ID</b>                 | Shows the ID of the operational vehicle.  |
| <b>Vehicle Orientation</b>        | <p>Shows the orientation of the operational vehicle.</p> <p><b>same:</b> Indicates that the operational vehicle has the same direction with respect to the operational train direction.</p> <p><b>inverse:</b> Indicates that the operational vehicle is in the opposite direction with respect to the operational train direction.</p> <p><b>unknown:</b> The direction of the operational vehicle is unknown.</p> |
| <b>Lead</b>                       | Shows whether the operational vehicle is leading.   |
| <b>Lead Direction</b>             | Shows the direction used for the operational vehicle.   |
| <b>Operational Vehicle Number</b> | Shows the index of the operational vehicle in the operational train.  |
| <b>Train Vehicle Number</b>       | Shows the index of the vehicle that the operational vehicle belongs to.   |
| <b>Operational Consist Number</b> | Shows the index of the operational consist the operational vehicle belongs to.  |

## TCN-URI Table

**Menu Path: Industrial Application > IEC 61375 > Operational Status - TCN-URI Table**

This page lets you see the mappings between Train Communication Network Uniform Resource Identifiers (TCN-URIs) and IP addresses.

### Operational Status

Consist Info   Train Directory   Operational Train Directory   **TCN-URI Table**

TCN-URI Table 2023/09/20 18:10:57

🔍 Search

| Index | TCN-URI                     | Train Network IP | Local IP   |
|-------|-----------------------------|------------------|------------|
| 1     | grpAll.aVeh.aCst.ITrn       | 239.193.0.0      |            |
| 2     | grpAll.aVeh.ICst.ITrn       | 239.194.0.0      |            |
| 3     | devCam1.opVeh01.anyCst.ITrn | 10.128.64.11     | 10.1.0.11  |
| 4     | devECSC.opVeh01.anyCst.ITrn | 10.128.64.201    | 10.1.0.201 |
| 5     | grpDoor.aVeh.aCst.ITrn      | 239.193.0.20     |            |

Items per page: 5   1 - 5 of 17

| UI Setting              | Description  |
|-------------------------|--|
| <b>Index</b>            | Shows the index number of the TCN-URI.   |
| <b>TCN-URI</b>          | Shows the Train Communication Network Uniform Resource Identifier (TCN-URI) of a component on the train. |
| <b>Train Network IP</b> | Shows the train network IP used for the TCN-URI.   |
| <b>Local IP</b>         | Shows the local IP used for the TCN-URI.   |

# Chapter 4

---

# Other Features

# Firmware Image Recovery Overview

Firmware Image Recovery refers to the use of multiple copies of firmware within a device to increase reliability and reduce the risk of system failure due to firmware corruption or errors.

In many electronic devices, firmware is stored in non-volatile memory such as flash memory, and any corruption or errors in the firmware can result in the device malfunctioning or becoming unusable. To mitigate this risk, firmware recovery involves storing multiple copies of the firmware within the device, and using a mechanism to switch to a backup copy of the firmware in case the primary copy becomes corrupted or fails.

Overall, Firmware Image Recovery is a useful technique for increasing the reliability and availability of electronic devices, particularly those used in critical applications where system failure can have serious consequences.

## Methodology

This device supports a “Dual-image” firmware mechanism to minimize the possibility of system failure, such as in the following situations:

1. When the user encounters an accident when upgrading the device firmware, such as a power outage, which may cause firmware corruption.
2. When the memory encounters lifespan issues or damage from external factors, parts of partitions may become corrupted.

This mechanism involves storing two copies of the firmware in separate memory partitions within the device, and using a boot loader to select the active copy at runtime. If a situation occurs, the firmware can still roll back to the previous version to boot the device.

### ▲ Warning

Firmware Image Recovery will not be able to help if the bootloader sector or the entire memory is corrupted.

## How Dual-imaging Works

Here is an overview of how the Dual-image function works.

1. When the product leaves the factory, it will keep two identical copies of the firmware version 1 in separate memory partitions A and B within the device. Partition A will be selected as the active copy by default.
2. When the user upgrades the firmware version 2, Partition B will be overwritten to store the new image as well as be selected as the active copy at the same time. Partition A will keep a previous version 1 as a backup.
3. When the user upgrades the firmware version 3, Partition A will be overwritten to store the new image as well as be selected as the active copy at the same time. Partition B will keep a previous version 2 as a backup.
4. Based on (3), if the user encounters an accident when upgrading the firmware version 3 and Partition A is corrupted, the bootloader will choose backup Partition B as the active one to continue to boot the system and the system will record a "Boot Failed, Fallback to Previous Firmware" event into the system logs.

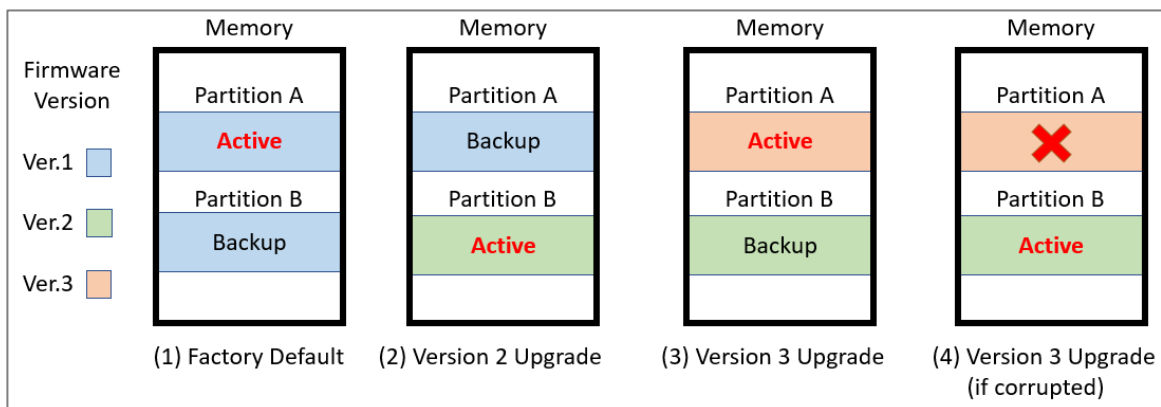

 **Note**

- Resetting the device to factory default settings only restores user configurations, and will not restore the firmware image in both partitions.
- This mechanism is done automatically by the system and is not user-configurable.



# Soft Lockdown

## Note

Soft Lockdown Mode is a feature designed for railway applications and is only supported by the TN-4900 Series.

Moxa routers can act as firewalls to help provide protection from external attacks that try to gain access and control over the network. On the other hand, while protecting the network, it is also important to prevent potential malfunctions that may occur and avoid unexpected network operation failures.

To handle this, Soft Lockdown Mode is a monitoring and protection mechanism that monitors important indicators and enters Soft Lockdown Mode once user-defined failure criteria are reached to ensure that device operation remains stable. For details about Soft Lockdown Mode settings, refer to [Firewall > Soft Lockdown Mode](#).

## Soft Lockdown Criteria

The criteria for entering and leaving Soft Lockdown Mode are defined by the following:

- **Performance Thresholds:** If the CPU utilization % exceeds a user-defined threshold, or the amount of free memory % goes below a user-defined threshold, a failure will be detected for the current cycle.
- **Monitoring Interval:** This defines how long a single monitoring cycle will be.
- **Number of Cycles to Enter Soft Lockdown Mode:** This defines how many consecutive cycles with failures are required to enter Soft Lockdown Mode.
- **Number of Cycles to Leave Soft Lockdown Mode:** This defines how many consecutive cycles without failures are required to leave Soft Lockdown Mode.
- **Critical Services:** If any of the following critical services are enabled, the device continually check to see whether the services are alive. The device will enter Soft Lockdown Mode if any enabled critical service is no longer alive, and all enabled critical services must be alive to leave Soft Lockdown Mode.

The critical services that apply to Soft Lockdown Mode are as follows:

- DHCP Server (refer to [Network Service > DHCP Server](#))

- DHCP Relay Agent (refer to [Network Service > DHCP Server - DHCP Relay Agent](#))
- SNMP Server (refer to [SNMP](#))
- Turbo Ring V2 (refer to [Redundancy > Layer 2 Redundancy > Turbo Ring V2](#))

#### ▲ Warning

When the device is operating normally, its CPU and memory usage can vary due to various factors. Apart from potential attacks, the number of devices connected to the router and application settings can also lead to increased demands on CPU and memory.

It is important to carefully assess the usage and configuration of this feature to avoid triggering Soft Lockdown Mode due to normal usage to avoid impacting regular operations.

## Entering Soft Lockdown Mode

The device will enter Soft Lockdown Mode when any of the following occur:

- The number of consecutive cycles with failures reaches the defined **Number of Cycles to Enter Soft Lockdown Mode**
- Any of the enabled **Critical Services** are no longer alive

## When in Soft Lockdown Mode

In Soft Lockdown Mode, the device will do the following:

- Block all traffic (both ingress and egress) on the interface specified for Soft Lockdown Mode
- Log the event and the reason for the event in the system log

#### ▲ **Warning**

When Soft Lockdown Mode is enabled, the port settings and VLAN settings should not be modified in order to prevent a mismatch for the Soft Lockdown Mode interface settings.

## Leaving Soft Lockdown Mode

The device will leave Soft Lockdown Mode under any of the following conditions:

- The number of normal consecutive cycles without failures reaches the defined **Number of Cycles to Leave Soft Lockdown Mode** AND all enabled **Critical Services** are alive.
- The device is restarted. After restarting, the device will enter normal operation and will only enter Soft Lockdown Mode if the criteria are fulfilled.

When leaving Soft Lockdown Mode, the device will do the following:

- Resume all traffic (both ingress and egress) on the interfaces where firewall rules are applied
- Log the event in the system log

# Serial Operation Modes

This device enables traditional serial (RS-232/422/485) devices to transmit data over a cellular network and allows you to access, manage, and configure remote facilities and equipment over the cellular network from anywhere in the world. The operation mode determines how the device's serial port will interact with the network. Which operation mode to select will depend on your specific application.

Traditional SCADA and data collection systems rely on the serial port to collect data from various types of instruments. Some software is required to connect the serial device to the COM port on the host computer. The Real COM and RFC 2217 modes allow you to expand a virtual COM port for a host computer on demand. As long as your host computer supports the TCP/IP protocol, SCADA and data collection systems will be able to access all instruments connected to a standard TCP/IP network, regardless of whether the devices are used locally or at a remote site.

The main difference between Real COM and RFC 2217 mode is that Real COM mode requires MOXA Windows Driver Manager to be installed on the host. The RFC 2217 mode allows third party drivers that support the RFC 2217 standard to perform virtual COM mapping to the serial port on the industrial secure router.

Some applications do not require the serial device to be physically connected connect to a COM port, but only need to establish a connection to receive data from the serial device. In that case, you can use TCP or UDP mode to establish the connection. The main difference between the TCP and UDP protocols is that TCP guarantees delivery of data by requiring the recipient to send an acknowledgement to the sender. UDP does not require this type of verification, making it possible to offer faster delivery.

TCP Server mode allows the host to request a connection to the industrial secure router. In TCP Client mode, the industrial secure router actively establishes a connection to a host computer for serial data transmission. If the industrial secure router is using a cellular connection and is difficult to access via fixed IP or VPN, you should select TCP Client mode and directly connect to the host.

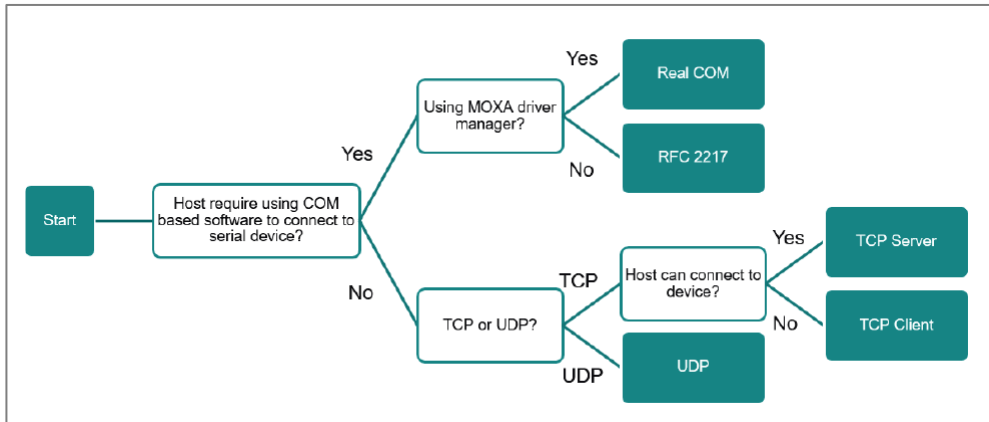

## Operation Mode - Real COM

In Real COM mode, the bundled drivers can establish a transparent connection between a host and a serial device by mapping the serial port on the industrial secure router to a local COM port on the host computer.

One of the major benefits of using Real COM mode is that it allows you to use software that was written for strictly serial communication applications. The Moxa driver manager intercepts data sent to the host's COM port, packs it into a TCP/IP packet, and then redirects it through the host's Ethernet card to the Internet. At the other end of the connection, the industrial secure router accepts the IP frame from the cellular network, unpacks the TCP/IP packet, and then transparently sends the data through the serial port to the attached serial device. This operation mode supports up to 2 simultaneous connections, enabling multiple hosts to collect data from the same serial device at the same time.

Make sure your cellular service provider offers a fixed public IP address or VPN solution to allow the host to access to the industrial secure router.

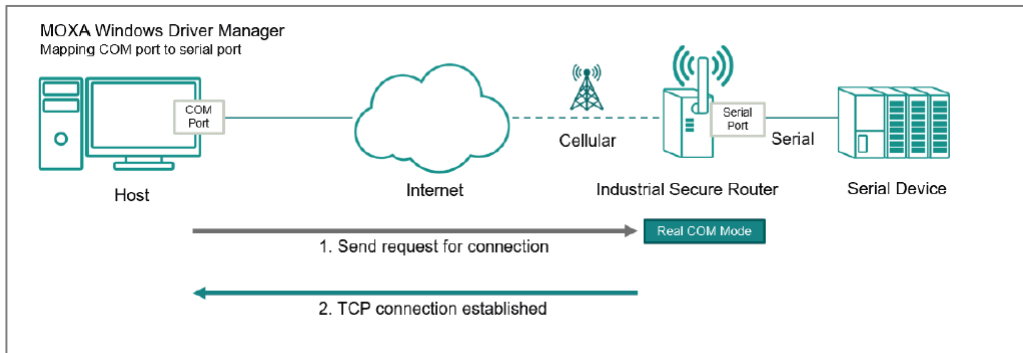

## Operation Mode - RFC 2217

Similar to Real COM mode, RFC-2217 mode also uses a driver to establish a transparent connection between a host computer and a serial device by mapping the serial port on the Industrial Secure Router to a local COM port on the host computer. RFC2217 defines general COM port control options based on the Telnet protocol. Third party drivers supporting RFC-2217 are widely available on the Internet and can be used to implement virtual COM mapping to serial port on the Industrial Secure Router. Make sure your cellular service provider offers a fixed public IP address or VPN solution to allow the host to access to the industrial secure router.

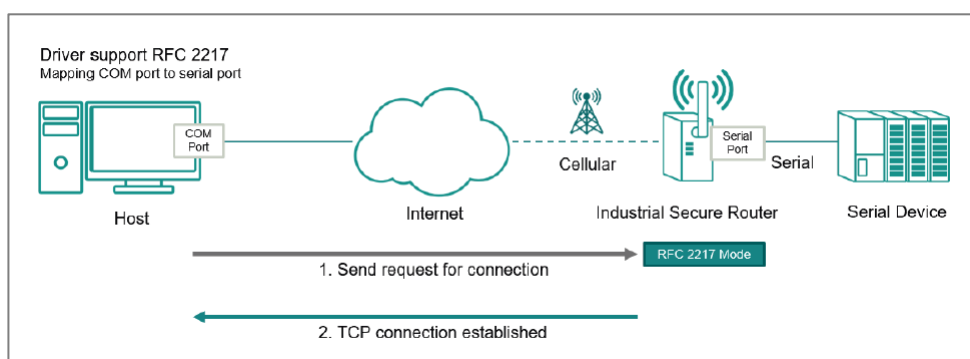

## Operation Mode - TCP Server

In TCP Server mode, the serial port on the Industrial Secure Router is assigned a unique IP/port combination on a TCP/IP network. The host computer initiates contact with the Industrial Secure Router, establishes the connection, and receives data from the serial

device. This operation mode supports up to 2 simultaneous connections, enabling multiple hosts to collect data from the same serial device at the same time.

Make sure your cellular service provider offers a fixed public IP address or VPN solution to allow the host to access to the industrial secure router.

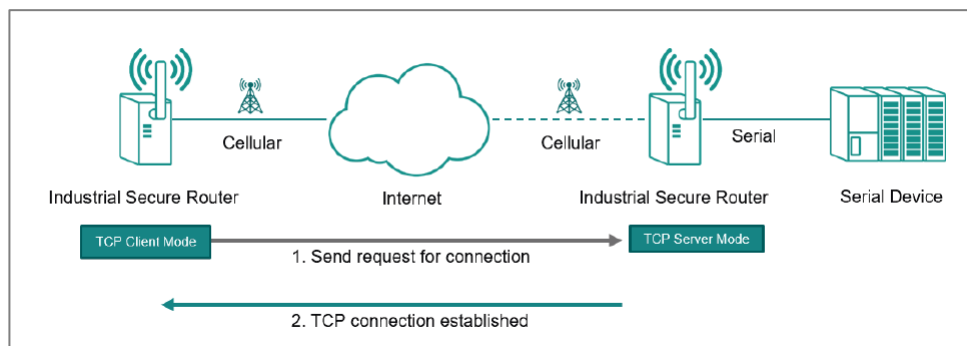
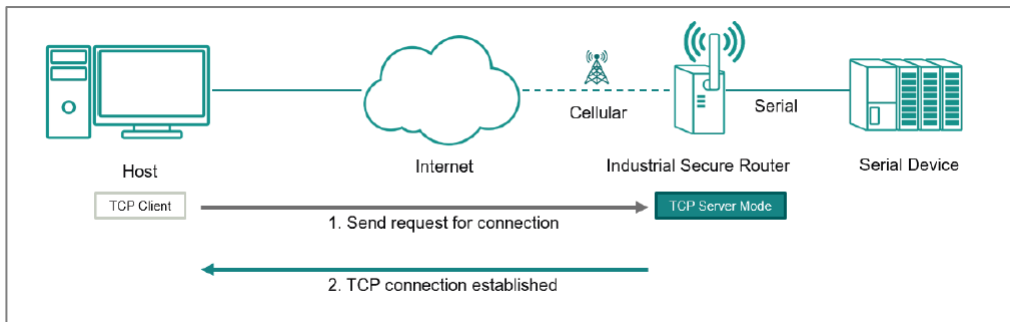

## Operation Mode - TCP Client

In TCP Client Mode, the Industrial Secure Router can actively establish a TCP connection with a predetermined host computer when serial data arrives. After the data has been transferred, the Industrial Secure Router can disconnect automatically from the host computer by using the TCP alive check time or inactivity time settings.

Make sure your cellular service provider offers a fixed public IP address or VPN solution to allow the host to access to the industrial secure router.

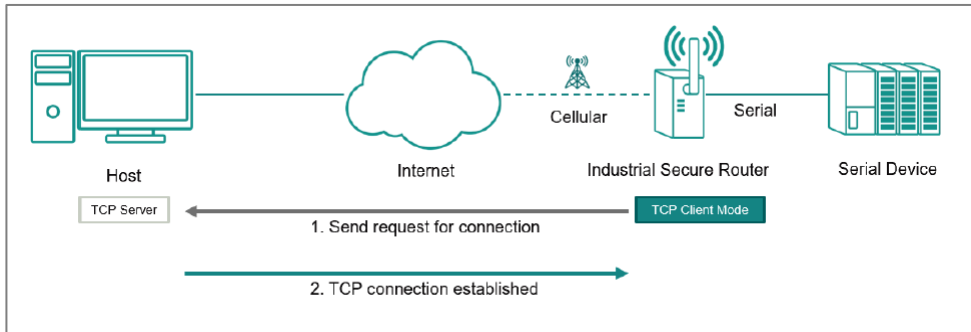

## Operation Mode - UDP

Compared to TCP communication, UDP is faster and more efficient. In UDP mode, you can unicast to one host or multicast to multiple hosts and the serial device can receive data from one or multiple host computers. These traits make UDP mode especially well-suited for message display applications.

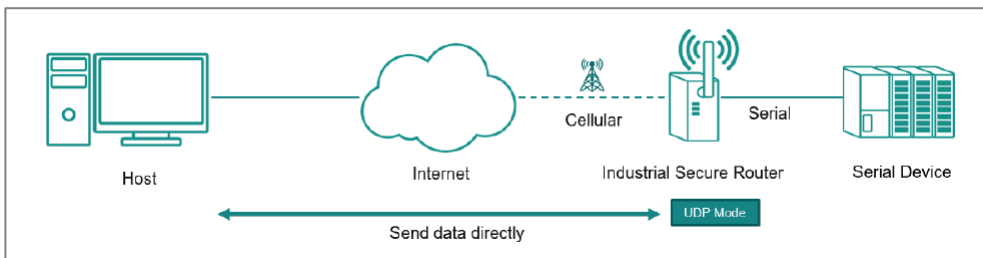



## Chapter 5

---

# Device Applications

# Device Applications Overview

This section goes over different device applications to help you better understand the applications themselves, and to show you how the device can help you implement those applications.

The following applications are covered:

- Network Segmentation
- Redundancy
- Routing
- OpenVPN Client
- NetFlow
- Loopback Interfaces

# Network Segmentation

## About Network Segmentation

Network Segmentation creates isolated virtual networks.

Segmenting a network reduces congestion and improves network performance by removing unnecessary traffic in a particular segment. For instance, segregating the passenger Wi-Fi network from the TCMS network in a train communication system ensures that the TCMS devices are not impacted by guest traffic. Such an approach helps to mitigate congestion and enhance the overall efficiency of the network.

There are two types of network segments:

- Layer-2 segments use numbered, virtual LAN segments (VLANs) to create isolated networks.
- Layer-3 segments use unique IP prefixes to create subnets.

## Layer-2 Segments

A layer-2 segment is essentially a single broadcast domain. All devices connected to the segment will receive any broadcast traffic sent within it. Layer-2 segmentation uses numbered VLANs to create isolated logical segment, which allows for the separation of traffic between different VLANs.

## Layer-3 Segments

In an IP network, a layer-3 segment is referred to as a subnetwork or subnet and includes all nodes that share the same network prefix as defined by their IP addresses and network mask. A router is needed to facilitate communication between layer-3 subnets. Hosts on the same subnet can communicate directly using the layer-2 segment that connects them.

## VLANs in Depth

A VLAN, or Virtual Local Area Network, is a logical grouping of devices on a network.

This technology allows network administrators to divide a large network into smaller, more manageable segments without the need for additional physical hardware. Devices within a VLAN can be located anywhere on the network but communicate as though they are on the same physical segment. This facilitates traffic management, as administrators can ensure traffic is directed only to devices within the same VLAN by assigning a VLAN tag to each Ethernet frame. Consequently, VLANs provide a means to segment a network beyond the constraints of physical connections, a limitation inherent in traditional network design. VLANs can be utilized to segment your network into various groups, such as:

- **Departmental groups**—One VLAN for the R&D department, another for Office Automation, etc.
- **Hierarchical groups**—One VLAN for directors, another for managers, and another for general staff.
- **Usage groups**—One VLAN for email users and another for multimedia users.

## VLAN Standards and Implementation

The functioning of VLANs is guided by IEEE 802.1Q, often referred to as Dot1q. This standard outlines the protocol for VLAN tagging on Ethernet frames within an IEEE 802.3 Ethernet network. During the transmission of data between switches, VLAN tags identify the VLAN ownership of frames. Networking equipment reads these tags and ensures that tagged frames are delivered to devices within that VLAN, maintaining the network's logical segmentation.

A VLAN tag is a specific piece of data embedded in the header of an Ethernet frame. It comprises a 4-byte field carrying key information, such as the VLAN ID (VID) and priority level. The VID is a numerical identifier that uniquely links the frame to a specific VLAN. The priority field within the tag plays a critical role in prioritizing certain types of traffic within a VLAN. This structure contributes to effective network traffic management by giving precedence to certain data when necessary.

## Benefits of VLANs

The main benefit of VLANs is that they provide a network segmentation system that is far more flexible than traditional networks. Using VLANs also provides you with three other benefits:

### **VLANS help control traffic**

With traditional networks, congestion can be caused by broadcast traffic that is directed to all network devices, regardless of whether or not they need it. VLANs increase the efficiency of your network because each VLAN can be set up to contain only those devices that need to communicate with each other.

### **VLANS simplify device relocation**

In traditional networks, administrators spend significant time managing moves and changes, requiring manual updates of host addresses when users switch sub-networks. In contrast, VLANs simplify this process. For example, when relocating a host from Port 1 to Port 6 in a different network section, simply assign Port 6 to the relevant VLAN (e.g., VLAN R&D A). This enables seamless communication between VLANs, eliminating the need for re-cabling.

### **VLANS provide extra security**

Devices within each VLAN can only communicate with other devices on the same VLAN. If VLAN R&D B needs to communicate with VLAN OA(Office Automation) A, the traffic must pass through a routing device or Layer 3 switch.

#### **Important**

Network segmentation is not a substitute for network security. While network segmentation can provide a degree of isolation that contributes to the overall security environment, the primary benefit of VLANs is improved performance by ensuring minimal crosstalk between unrelated systems. Network segmentation should be complimented with network security procedures.

## **Scenario: Layer 2 Segmentation of 3 Factories**

**Short Description:** A manufacturer uses layer 2 segmentation to manage traffic between three different factories, each with many devices.

Two switches are used to connect the all of the devices together on the same network, but devices from any factory may be connected to either switch. To simplify management and ensure smooth operations, we can configure the switches to make sure that each factory is on its own VLAN.

Each VLAN can be enlarged using simple switches to connect any number of devices in the factory

For our example scenario, we will simplify to two devices connected to each switch. Traffic VLANs are usually assigned to ports, so it's important to note which port we'll be using for each device. The switches are connected each other using port 8, and will allow VLANs to be split between the two switches as necessary, without causing interference or performance drops on the others.

We need a topology that:

- Allows devices on the same VLAN to communicate with each other
- Ensure devices on different VLANs cannot communicate with each other

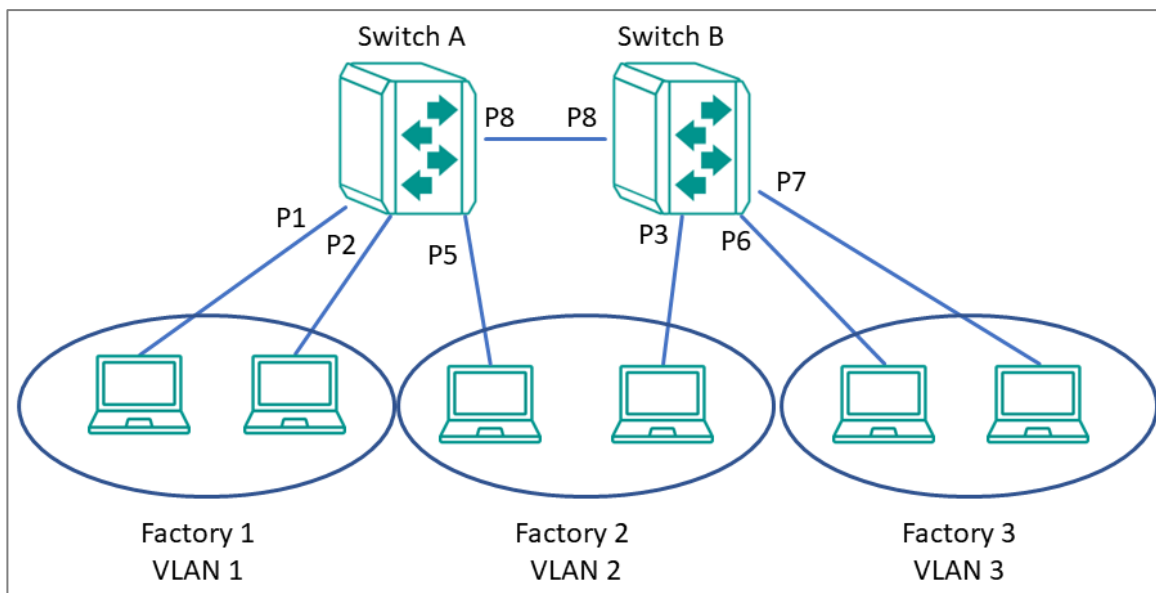

This diagram outlines how we might create a network meeting these requirements. Each factory is on its own VLAN, and that Factory 2's VLAN is split between two switches. With VLAN segmentation and a Trunk connecting the two switches, Factory 2's VLAN will have comparable performance to VLANs within the same switch. Because of VLAN isolation, administrators can manage and prioritize traffic to ensure that packets do not leave their corresponding VLAN.

#### Important

Be careful when configuring VLANs on a remote switch. Modifications to the configuration could affect connectivity. For example, if the management VLAN of the switch is VLAN 1 and you are connected to ports that do not belong to VLAN 1, you may be disconnected from the switch during configuration.

## Example: Creating VLANs for Layer 2 Segmentation of 3 Factories

Create VLANs in preparation for assigning them to ports.

**Before you begin:** Make sure you have an environment configured in line with our scenario. This includes:

- 3 routers in a ring topology with backbone connected on ports 7 and 8
- 2 gateways for each router (Service A and Service B), connected at ports 1 and 2, respectively
- Administrator credentials to all three routers

To create VLANs for this example, do the following:

1. Sign in to Switch A using administrator credentials.
2. Go to **Network Configuration**→**Layer 2 Switching**→**VLAN**.
3. To add a VLAN ID, click on the **Settings** tab, and then click the **Add (+)** button.  
**Result:** The **Create VLAN** screen appears.
4. Specify the VLAN to create in the VID, and then click Create. For Factory 1, we will create VLAN 1.  
**Result:** The VLAN will appear on the VLAN table at the top of the page.
5. Repeat this process to create VLANs 2 and 3 for the factories, and then create VLAN 1000 for the link between switches.

**Results:** We created VLANs for each factory (VIDs 1, 2, 3) and the VLAN for communication between switches (VID 1000).

**What to do next:** After you have created all 4 VLANs on Switch A, repeat this process on Switch B. Once Switch B is configured, you can continue on to assigning VLANs to ports.

## Example: Assigning VLANs to Ports on Switch A

VLANs must be assigned to ports on Switch A to route traffic correctly.

Now that you've created the VLANs, they need to be assigned to ports so that traffic from those ports will be routed over the correct VLAN. A similar procedure must be performed on each switch or router on the network.

1. Sign in to Switch A using administrator credentials.
2. Go to **Network Configuration**→**Layer 2 Switching**→**VLAN**.

- To assign the newly created VLAN ID to a port, find the port on the **Port Table** on the lower part of the page, and then click the corresponding  **[Edit]** button. Since we're assigning factory 1 to ports 1 and 2, start with **Port 1**. If you are repeating this step, you can substitute **Port 1** with information from the table at the end of this procedure.

**Result:** The **Edit Port Settings** panel appears.

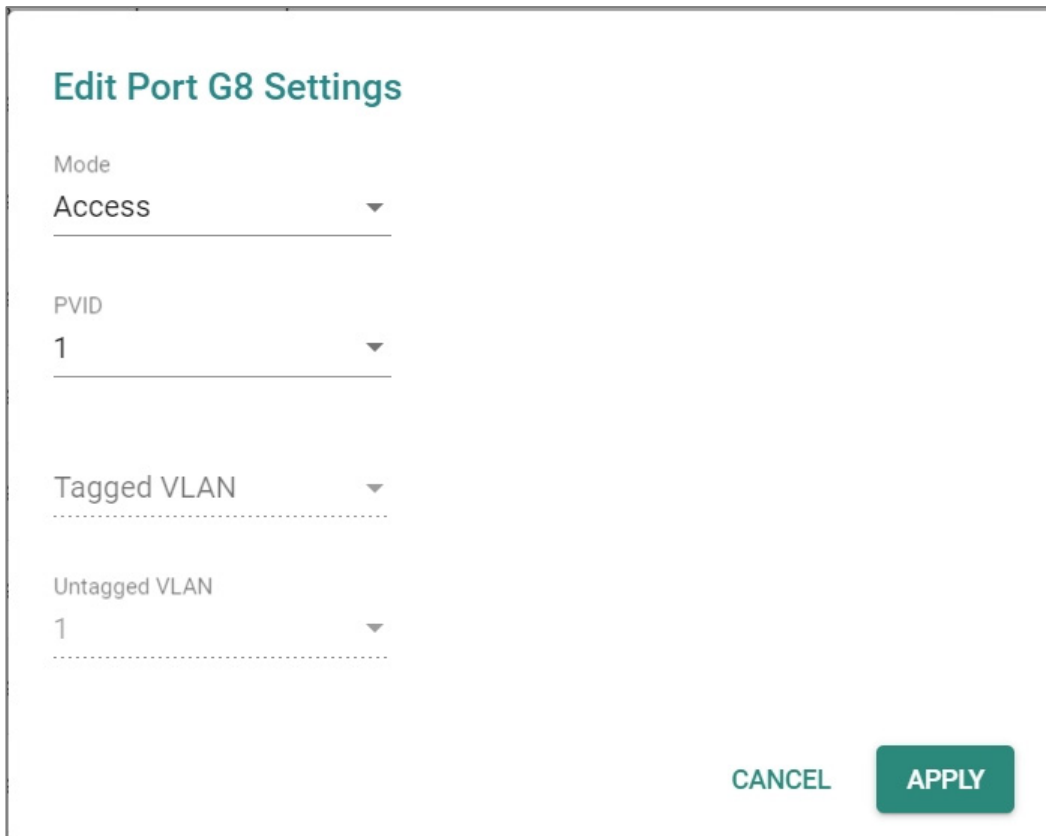

**Edit Port G8 Settings**

Mode  
Access

PVID  
1

Tagged VLAN

Untagged VLAN  
1

CANCEL APPLY

- Specify the **Mode** and **PVID** that will be assigned to the port, and then click **Apply**.

To assign the chosen port to Factory 1, specify **Mode Access** and **PVID** as 1.

**Tutorial Info:**

Access mode is used when connecting single devices without tags. These are usually end-user devices that belong to a single VLAN, and do not need to communicate with devices in other VLANs.

Trunk mode allows a port to carry traffic for multiple VLANs over a single physical connection. This is useful for linking switches together that may have many different VLANs.

Hybrid mode is similar to a Trunk port, except users can explicitly assign tags to be removed from egress packets.



Note: The port VID (PVID) setting will apply a VLAN tag only for untagged traffic coming through that port. If traffic going through the port has already been tagged with a VLAN ID, the PVID setting will not change the existing tag.

**Result:** The **Port Table** will show the new port configuration.

5. To add the remaining ports, repeat this procedure with the following substitutions and settings:

| Port | Settings  |
|------|---|
| 2    | <ul style="list-style-type: none"><li>• <b>PVID: 1</b></li><li>• <b>Mode: Access Mode</b></li></ul>   |
| 5    | <ul style="list-style-type: none"><li>• <b>PVID: 2</b></li><li>• <b>Mode: Access Mode</b></li></ul>   |
| 8    | <ul style="list-style-type: none"><li>• <b>PVID: 1000</b></li><li>• <b>Mode: Trunk Mode</b></li><li>• <b>Tagged VLAN: 1, 2, 3</b></li></ul> |

**Results:** Ports on Switch A have been assigned VIDs and modes, ensuring that untagged traffic on ports 1 and 2 will automatically be tagged as VLAN 1. Traffic on port 5 will be automatically tagged as VLAN 2. Port 8 has been configured as a Trunk that will allow traffic to move between switches while retaining the tags.

**What to do next:** Assign VLANs to Ports on Switch B.

#### Important

The Port settings on each switch will be slightly different. Make sure each switch is configured correctly by following the instructions for Switch B.

## Example: Assigning VLANs to Ports on Switch B

VLANs must be assigned to ports on Switch B to route traffic correctly.

Now that you've created the VLANs, they need to be assigned to ports so that traffic from those ports will be routed over the correct VLAN. A similar procedure must be performed on each switch or router on the network.

1. Sign in to Switch A using administrator credentials.
2. Go to **Network Configuration**→**Layer 2 Switching**→**VLAN**.

- To assign the newly created VLAN ID to a port, find the port on the **Port Table** on the lower part of the page, and then click the corresponding  **[Edit]** button. Since we're assigning factory 2 to port 3, start with **Port 3**. If you are repeating this step, you can substitute **Port 3** with information from the table at the end of this procedure.

**Result:** The **Edit Port Settings** panel appears.

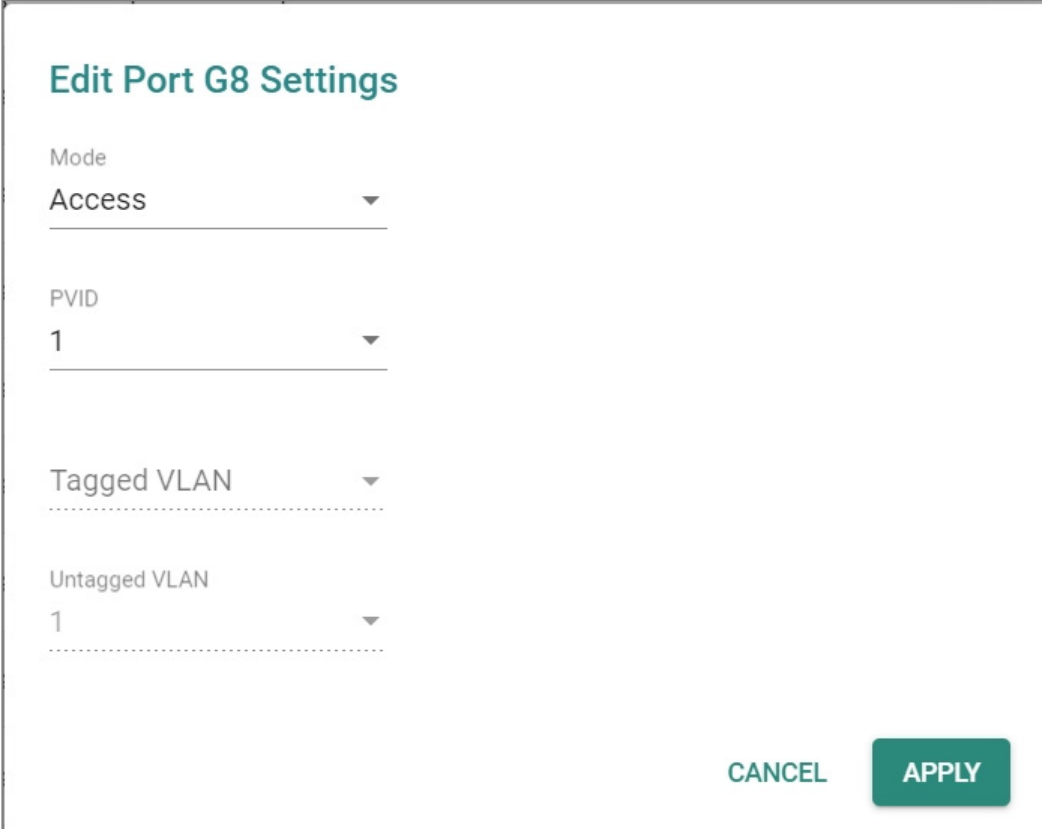

**Edit Port G8 Settings**

Mode  
Access

PVID  
1

Tagged VLAN

Untagged VLAN  
1

CANCEL APPLY

- Specify the **Mode** and **PVID** that will be assigned to the port, and then click **Apply**.

To assign the chosen port to Factory 3, specify **Mode Access** and **PVID** as 2.

**Tutorial Info:**

Access mode is used when connecting single devices without tags. These are usually end-user devices that belong to a single VLAN, and do not need to communicate with devices in other VLANs.

Trunk mode allows a port to carry traffic for multiple VLANs over a single physical connection. This is useful for linking switches together that may have many different VLANs.

Hybrid mode is similar to a Trunk port, except users can explicitly assign tags to be removed from egress packets.

Note: The port VID (PVID) setting will apply a VLAN tag only for untagged traffic coming through that port. If traffic going through the port has already been tagged with a VLAN ID, the PVID setting will not change the existing tag.

**Result:** The **Port Table** will show the new port configuration.

- To add the remaining ports, repeat this procedure with the following substitutions and settings:

| Port | Settings  |
|------|---|
| 6    | <ul style="list-style-type: none"><li>• <b>PVID: 1</b></li><li>• <b>Mode: Access Mode</b></li></ul>   |
| 7    | <ul style="list-style-type: none"><li>• <b>PVID: 2</b></li><li>• <b>Mode: Access Mode</b></li></ul>   |
| 8    | <ul style="list-style-type: none"><li>• <b>PVID: 1000</b></li><li>• <b>Mode: Trunk Mode</b></li><li>• <b>Tagged VLAN: 1, 2, 3</b></li></ul> |

**Results:** Ports on Switch B have been assigned VIDs and modes, ensuring that untagged traffic on ports 6 and 7 will automatically be tagged as VLAN 3. Traffic on port 3 will be automatically tagged as VLAN 2. Port 8 has been configured as a Trunk that will allow traffic to move between switches while retaining the tags.

When combined with the previous settings, we complete the network segmentation. Traffic on VLANs 1-3 will remain isolated, and VLAN 1000 will allow traffic between switches while retaining VLAN tagging.

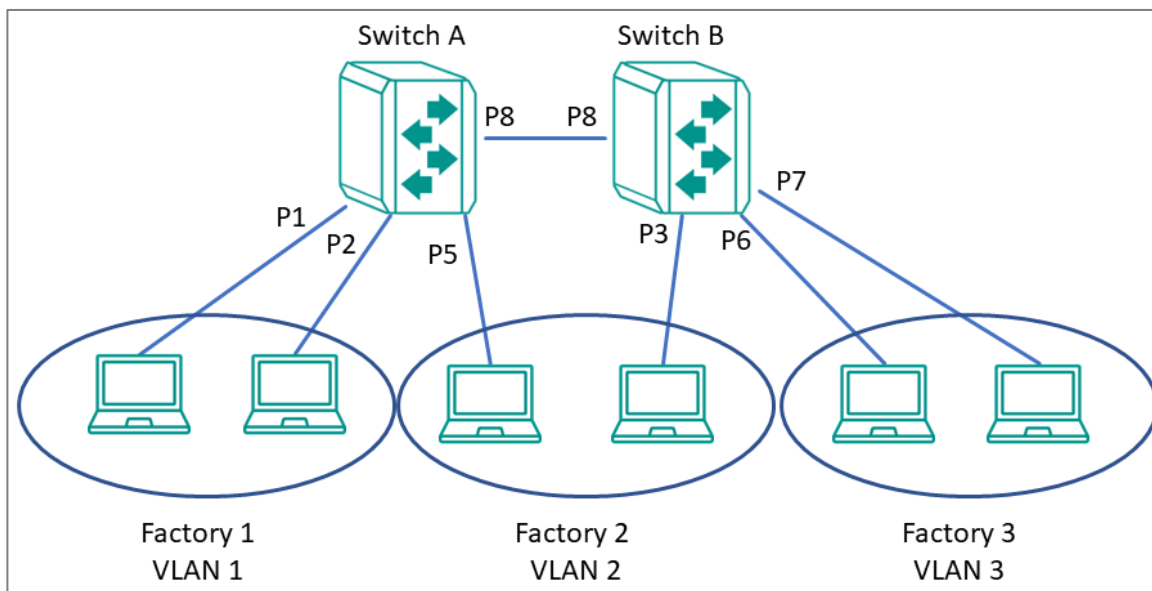

## Scenario: Layer 3 Segmentation of Two Services

**Short Description:** A manufacturer uses layer 3 segmentation to manage traffic between three different factories, each with many devices.

Three routers are used to connect all of the devices together on the same network, but devices from any factory may be connected to either switch. Each factory has devices running Service A and Service B. Devices need to connect to the corresponding service in other factories, while being isolated from the different services in their own factories.

Each VLAN can be enlarged using simple switches to connect any number of devices in the factory.

For our example scenario, we will simplify to two devices (one for each service) connected to each router. These devices will serve as gateways for additional devices connected to their corresponding service. We can assign separate subnets to each port (an interface), so it's important to note which port we'll be using for each device.

We need a topology that:

- Allows devices on the same subnet to communicate with each other
- Ensure devices on different subnet cannot communicate with each other

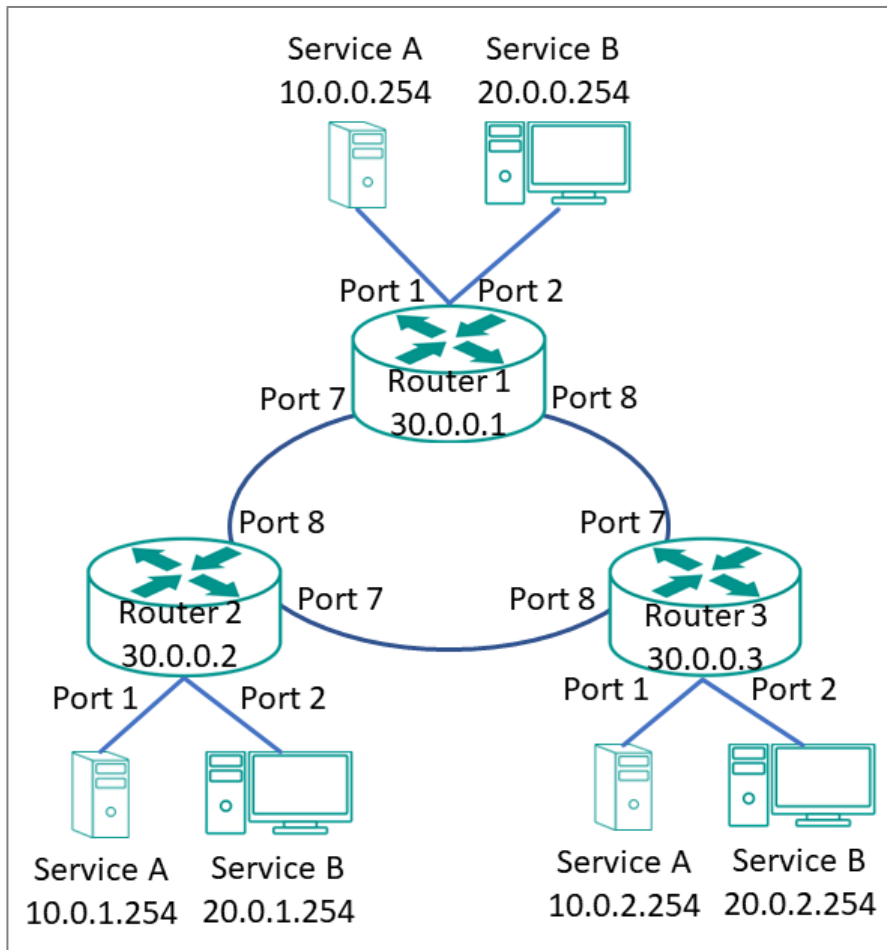

This diagram outlines how we might create a network meeting these requirements. Each service is on its own subnet. Routers are connected in a ring topology, also on its own subnet. Because of subnet isolation, administrators can manage and prioritize traffic to ensure that packets do not leave their corresponding subnet.

To deploy this topology we need to do the following:

- Configure VLANs for each interface and bind them to ports
- Configure IP ranges for each interface and assign them to ports

In our example, we are segmenting by Service, rather than by area.

### Example: Creating VLANs for Layer 3 Segmentation

Create VLANs in preparation for assigning them to ports.

**Before you begin:** Make sure you have an environment configured in line with our scenario. This includes:

- 3 routers in a ring topology with backbone connected on ports 7 and 8
- 2 gateways for each router (Service A and Service B), connected at ports 1 and 2, respectively
- Administrator credentials to all three routers

To create VLANs for this example, do the following:

1. Sign in to Switch A using administrator credentials.
2. Go to **Network Configuration**→**Layer 2 Switching**→**VLAN**.
3. To add a VLAN ID, click on the **Settings** tab, and then click the  **[Add]** button.  
**Result:** The **Create VLAN** screen appears.
4. Specify the VLAN to create in the **VID**, and then click **Create**. For Service A, we will create VLAN 10.  
**Result:** The VLAN will appear on the VLAN table at the top of the page.
5. Repeat this process to create VLAN 20 for Service B, and then create VLAN 1000 for the link between switches.

**Results:** We created VLANs for each Service (VIDs 10 and 20) and the VLAN for backbone between different sites (VID 1000).

**What to do next:** After you have created all 3 VLANs on Router 1, repeat this process on Routers 2 and 3. The configuration options will be the same. Once VLANs have been configured on all routers, you can move on to assigning VLANs to ports.

### Example: Assigning VLANs to Ports for Layer 3 Segmentation

VLANs must be assigned to ports on each router to route traffic correctly.

Now that you've created the VLANs, they need to be assigned to ports so that traffic from those ports will be routed over the correct VLAN. A similar procedure must be performed on each switch or router on the network.

1. Sign in to Router 1 using administrator credentials.
2. Go to **Network Configuration**→**Layer 2 Switching**→**VLAN**.
3. To assign the newly created VLAN ID to a port, find the port on the **Port Table** on the lower part of the page, and then click the corresponding  **[Edit]** button.

Since we're assigning Service A to port 1, start with **Port 1**. If you are repeating this step, you can substitute **Port 1** with information from the table at the end of this procedure.

**Result:** The **Edit Port Settings** panel appears.

**Edit Port G8 Settings**

Mode  
Access

PVID  
1

Tagged VLAN

Untagged VLAN  
1

CANCEL APPLY

4. Specify the **Mode** and **PVID** that will be assigned to the port, and then click **Apply**.

To assign the chosen port to Service A, specify **Mode Access** and **PVID** as 10.

**Tutorial Info:**

Access mode is used when connecting single devices without tags. These are usually end-user devices that belong to a single VLAN, and do not need to communicate with devices in other VLANs.

Trunk mode allows a port to carry traffic for multiple VLANs over a single physical connection. This is useful for linking switches together that may have many different VLANs.

Hybrid mode is similar to a Trunk port, except users can explicitly assign tags to be removed from egress packets.

Note: The port VID (PVID) setting will apply a VLAN tag only for untagged traffic coming through that port. If traffic going through the port has already been tagged with a VLAN ID, the PVID setting will not change the existing tag.

**Result:** The **Port Table** will show the new port configuration.

5. To add the remaining ports, repeat this procedure with the following substitutions and settings:

| Port | Settings   |
|------|--|
| 2    | <ul style="list-style-type: none"><li>• <b>PVID:</b> 10</li><li>• <b>Mode:</b> Access Mode</li></ul>                                       |
| 5    | <ul style="list-style-type: none"><li>• <b>PVID:</b> 20</li><li>• <b>Mode:</b> Access Mode</li></ul>                                       |
| 7    | <ul style="list-style-type: none"><li>• <b>PVID:</b> 1000</li><li>• <b>Mode:</b> Trunk Mode</li><li>• <b>Tagged VLAN:</b> 10, 20</li></ul> |
| 8    | <ul style="list-style-type: none"><li>• <b>PVID:</b> 1000</li><li>• <b>Mode:</b> Trunk Mode</li><li>• <b>Tagged VLAN:</b> 10, 20</li></ul> |

**Results:** Ports on Router 1 have been assigned VIDs and modes, ensuring that untagged traffic on Port 1 will automatically be tagged as VLAN 10. Traffic on port 2 will be automatically tagged as VLAN 20. Port 8 has been configured as a Trunk that will allow traffic to move between switches while retaining the tags.

### Example: Assigning IPs to Router Interfaces

IP subnets must be assigned to interfaces to ensure traffic from corresponding VLANs is segmented correctly.

To assign IPs to router interfaces:

1. Sign in to Router 1 using administrator credentials.
2. Go to **Network Configuration**→**Network Interfaces**→**LAN**, and then press   
**[Add]**.

**Result:** The **Create LAN Interface Entry** screen appears.



3. To add the interface for Service A, specify all of the following, and then click **Create**:

| Field             | Setting              |
|-------------------|----------------------|
| <b>Name</b>       | Service A            |
| <b>VLAN ID</b>    | 10                   |
| <b>IP Address</b> | 10.0.1.254           |
| <b>Netmask</b>    | <b>8 (255.0.0.0)</b> |

**Result:** The LAN interface will appear on the Network Interface list.

4. To add the interface for Service B, specify all of the following, and then click **Create**:

| Field             | Setting              |
|-------------------|----------------------|
| <b>Name</b>       | Service B            |
| <b>VLAN ID</b>    | 20                   |
| <b>IP Address</b> | 20.0.1.254           |
| <b>Netmask</b>    | <b>8 (255.0.0.0)</b> |

**Result:** The LAN interface will appear on the Network Interface list.

5. To add the interface for the backbone connection, specify all of the following, and then click **Create**:

| Field             | Setting              |
|-------------------|----------------------|
| <b>Name</b>       | Backbone             |
| <b>VLAN ID</b>    | 1000                 |
| <b>IP Address</b> | 30.0.0.1             |
| <b>Netmask</b>    | <b>8 (255.0.0.0)</b> |

**Result:** The LAN interface will appear on the Network Interface list.

**Results:** Interfaces have been configured on Router 1 to allow effective network segmentation. Now you need to configure the additional networks.

**What to do next:** Repeat this task with the following adjustments:

| Router          | Item      | Value      |
|-----------------|-----------|------------|
| <b>Router 2</b> | Service A | 10.0.2.254 |
|                 | Service B | 20.0.2.254 |
|                 | Backbone  | 30.0.0.2   |
| <b>Router 3</b> | Service A | 10.0.3.254 |
|                 | Service B | 20.0.3.254 |
|                 | Backbone  | 30.0.0.3   |

Once all routers have been configured with the correct IP interfaces, you can configure a routing solution. Once that's done, your network will be ready to use.

### Example: Configuring Static Routing for Layer 3 Segmentation

For complex environments, routing must be configured.

This example uses simple static routing to route traffic across the network. A production network may chose a dynamic routing option instead.

To configure dynamic routing for the Layer 3 example:

1. Sign in to Switch A using administrator credentials.
2. Go to **Routing**→**Unicast Route**→**Static Routes**, and then click the **Add (+)** icon.

**Result:** The **Create new static route** panel appears.

3. Specify all of the following:

| Item          | Value              |
|---------------|--------------------|
| <b>Name</b>   | Service A Router 2 |
| <b>Status</b> | <b>Enable</b>      |

| Item                       | Value   |
|----------------------------|---|
| <b>Destination Address</b> | <b>10.0.1.254</b><br>Refers to Production Service A on Router 2.                    |
| <b>Subnet Mask</b>         | <b>8 (255.0.0.0)</b><br>Refers to the subnet mask of the destination address.       |
| <b>Next Hop</b>            | <b>30.0.0.2</b><br>Refers to the Router 2 Interface as the next hop on the network. |
| <b>Metric</b>              | <b>1</b>  |

4. Click **Create**.

**Result:** The new static routing entry should appear in the routing table.

5. Repeat this process for Service B. Specify all of the following:

| Item                       | Value   |
|----------------------------|---|
| <b>Name</b>                | <b>Service B Router 2</b>   |
| <b>Status</b>              | <b>Enable</b>   |
| <b>Destination Address</b> | <b>20.0.1.254</b><br>Refers to Production Service A on Router 2.                    |
| <b>Subnet Mask</b>         | <b>8 (255.0.0.0)</b><br>Refers to the subnet mask of the destination address.       |
| <b>Next Hop</b>            | <b>30.0.0.2</b><br>Refers to the Router 2 Interface as the next hop on the network. |
| <b>Metric</b>              | <b>1</b>  |

6. Once this step is complete, repeat the process on Routers 2 and 3. The information for each router should appear as follows:

| Item                       | Service A Router 1             | Service B Router 1             | Service A Router 2             | Service B Router 2             | Service A Router 3             | Service B Router 3             |
|----------------------------|--------------------------------|--------------------------------|--------------------------------|--------------------------------|--------------------------------|--------------------------------|
| <b>Appears On</b>          | Routers 2/3                    | Routers 2/3                    | Routers 1/3                    | Routers 1/3                    | Routers 1/2                    | Routers 1/2                    |
| <b>Name</b>                | Service A Router 1             | Service B Router 1             | Service A Router 2             | Service B Router 2             | Service A Router 3             | Service B Router 3             |
| <b>Status</b>              | <b>Enable</b>                  | <b>Enable</b>                  | <b>Enable</b>                  | <b>Enable</b>                  | <b>Enable</b>                  | <b>Enable</b>                  |
| <b>Destination Address</b> | 10.0.0.25<br>4                 | 20.0.0.25<br>4                 | 10.0.0.25<br>4                 | 20.0.1.25<br>4                 | 10.0.0.25<br>4                 | 20.0.2.25<br>4                 |
| <b>Subnet Mask</b>         | <b>8</b><br><b>(255.0.0.0)</b> | <b>8</b><br><b>(255.0.0.0)</b> | <b>8</b><br><b>(255.0.0.0)</b> | <b>8</b><br><b>(255.0.0.0)</b> | <b>8</b><br><b>(255.0.0.0)</b> | <b>8</b><br><b>(255.0.0.0)</b> |
| <b>Next Hop</b>            | 30.0.0.1                       | 30.0.0.1                       | 30.0.0.2                       | 30.0.0.2                       | 30.0.0.3                       | 30.0.0.3                       |
| <b>Metric</b>              | 1                              | 1                              | 1                              | 1                              | 1                              | 1                              |

**Results:** Once the routing configuration is completed, the Example Layer 3 Segmented Network will be ready to use. This will ensure that packets for each service will be isolated from the other, while still be efficiently guided around the network.

# About Redundancy

Redundancy in industrial networks refers to averting the impact of unexpected shutdowns. If a service becomes unavailable, it can cause interruptions to productivity and services, resulting in potentially significant losses for businesses. Therefore, it is crucial to establish a redundancy protocol to quickly recover from any abnormalities and maintain productivity.

## What kinds of redundancy protocols are there?

Moxa network devices support a variety of network redundancy protocols for both OSI Layer 2 and Layer 3.

- Layer 2: Moxa devices have redundancy protocol support for RSTP, MSTP, Turbo Ring v2, Turbo Chain, Ring Coupling, and Dual Homing for pathway redundancy. These mechanisms establish alternative paths that can be used to reach a destination if the primary connection fails.
- Layer 3: Moxa devices use Virtual Router Redundancy Protocol (VRRP) to ensure that the default gateway function can switch to a backup device in case the primary device fails. This ensures that routing functions remain available even if the primary device goes offline.

By implementing redundancy mechanisms at both Layer 2 and Layer 3, you can help ensure that your networks are reliable and available, even in the event of a failure or outage.

## About Layer 2 Redundancy Protocols

Selecting the appropriate Layer 2 redundancy protocol for your network depends on several factors, including:

- The topology and size of your network
- The applications and services you are running
- Your availability and performance requirements

Suggestions for protocol selection will be mentioned in later chapters. Here's a brief summary of each protocol to help you make an informed decision.

| Category                   |  | RSTP  | Turbo Ring v2   | Turbo Chain  |
|----------------------------|--|---|---|--|
| <b>Specification needs</b> | Diameter                                       | 40 pcs  | <b>V</b><br>250 nodes per ring  | <b>V</b><br>250 nodes per chain  |
|                            | Recovery Time                                  |   | <b>V</b><br>Fast Ethernet: 20 ms<br>Gigabit Ethernet: 50 ms   | <b>V</b><br>Fast Ethernet: 20 ms<br>Gigabit Ethernet: 50 ms  |
|                            | Link Health Check (Packet Detection Mechanism) | <b>V</b><br>2 sec/1 RSTP BPDU (default)   | <b>O</b><br>Gigabit Ethernet: 10 ms/LHC pkt.  | <b>O</b><br>Gigabit Ethernet: 10 ms/LHC pkt.   |
| <b>Application needs</b>   | Multi-Vendor Support                           | <b>V</b><br>Public Standard   | Moxa proprietary  | Moxa proprietary   |
|                            | Easy-Deployment                                | Mesh  | <b>V</b><br>Ring Topology   | <b>V</b><br>Chain Topology   |
|                            | Flexible Scalability                           |   | <b>O</b><br>Turbo Ring + Ring Coupling  | <b>V</b><br>Directly connected to existing network without any changes.  |
| <b>Supported Models</b>    |  | Managed switch: EDS series, IKS series, ICS series, TN series, PT series, RKS series, MDS series.<br>Router: EDR series, TN series. | Managed switch: EDS series, IKS series, ICS series, TN series, PT series, RKS series, MDS series.<br>Router: EDR series, TN series. | Managed switch: EDS series, IKS series, ICS series, TN series, PT series, RKS series, MDS series.<br>Router: EDR series. |

**V:** Most appropriate

**O:** Partially applicable

# About Scenarios for Turbo Chain and Turbo Ring

## Large Semiconductor Network

A semiconductor factory plans to construct a new facility to increase chip production capacity for future electric vehicles. They require a large automated network (100+ switches) with redundant mechanisms to prevent unexpected downtime that could impact production lines. Additionally, their network must balance traffic across multiple links to prevent congestion and improve overall performance.

### Analysis

1. This is a new project with no existing infrastructure.
2. A redundancy protocol is required and must support a network with at least 100 switches.
3. Link aggregation is needed to increase total throughput beyond what a single connection can sustain.

## Solution: Turbo Ring v2

Turbo Ring v2 is suitable in situations where extremely fast failover times are required, such as in mission-critical industrial control systems. Turbo Ring v2 facilitates easy ring topology deployment. With Moxa Turbo Ring technology, networks can recover within 20 ms (Fast Ethernet/fiber) or 50ms (gigabit copper) on a network with up to 250 nodes.

## Legacy Rapid Transit Network

A Phase II Metro project needs to build 15 new metro stations in an existing transit system, each requiring networking infrastructure. This project not only establishes its own system with a redundant topology but also ensures compatibility with the Phase I system. The Phase I system comprises a mesh topology with RSTP protocol, consisting of over 30 switches, with cabling that is outdated and no longer replaceable. Nevertheless, Phase II must be interconnected with Phase I without any modifications to the latter.

### Analysis

1. This is a rebuilt project and it should be interconnected with RSTP topology.
2. Redundancy protocol is required and support 100+ switches network.

## **Solution: Turbo Chain**

Turbo Chain is most suitable for this situation. One of the key advantages of Turbo Chain is its simplicity and ease of deployment. It can be directly interconnected to RSTP topology with any change on RSTP network.

Note:

The following two alternative solutions would also work in this scenario:

1. Turbo Ring v2 with Ring coupling to RSTP is also an alternate solution. This would depend on network physical deployment.
2. RSTP could be used to expand an existing RSTP network.

## **Inter-Consist Rail Network**

A well-known railway vehicle manufacturer needs to plan a new on-board network, planning a ring network via Turbo Ring for multiple vehicles to form a consist. The consists also need to be interconnected with each other when connected as a train, and a redundant backup mechanism should be provided between consists.

## **Solution: Ring Coupling**

Connection between Turbo Ring networks can be connected with ring coupling. This will allow consists with their own rings to be dynamically uncoupled and recoupled without reconfiguration.

## **About Turbo Ring v2**

Turbo Ring v2 is a high-performance, redundant network topology developed by Moxa for configuring network devices in redundant loops.

In the event of a link failure, the network can automatically reconfigure itself to maintain uninterrupted communication. Recovery times are within 20 ms for Fast Ethernet and 50 ms for Gigabit Ethernet on a network of up to 250 nodes.



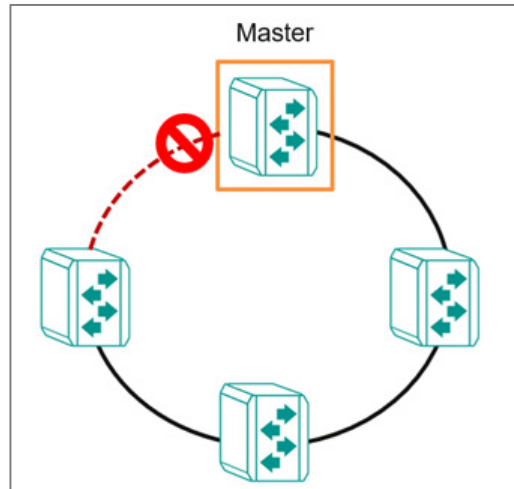

Turbo Ring v2 allows connected network devices to elect a "master" switch, which blocks packets from traveling through any of the network's redundant loops and manages the network. If a section breaks, the protocol adjusts the ring so that the disconnected parts of the network establish contact. This enables continuous network operations, even when there is a fault in the network.

Furthermore, the election mechanism is redundant. If the "master" device itself fails, the network devices detect the failure and automatically elect another. The process occurs quickly, ensuring no interruption.

Turbo Ring v2 supports a backup segment connected to the redundant port (secondary port) on the ring "master". In this case, the backup path is easily identifiable for troubleshooting and replacement.

## About Ring Coupling

Ring Coupling refers to the practice of coupling two rings together.

This may be useful when creating a large redundant ring is inconvenient or impractical, such as for devices in remote areas. Smaller redundant rings can be coupled together for inter-ring communication while still maintaining redundancy of constituent rings and couplings.

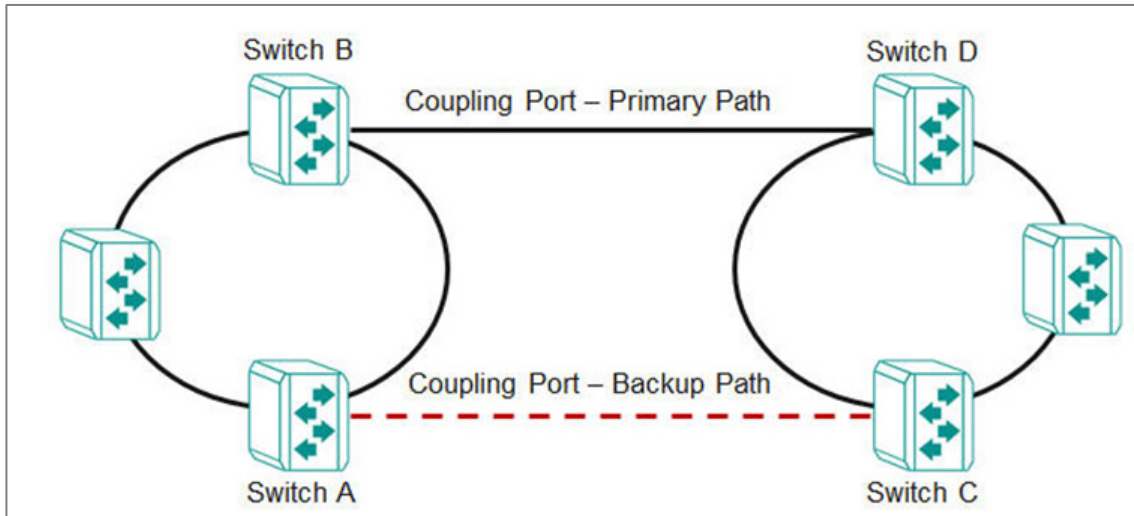

Ring coupling uses extra ports on each pair of coupled switches. In this example, that means:

- The (Primary) coupling port on Switch B monitors the main path and connects directly to the port on Switch D.
- The (Backup) coupling port on Switch A monitors the main path and connects directly to the port on Switch C.

**Note**

Only one coupling (primary + backup) per ring pair.

## Scenario: Using Turbo Ring in a Manufacturing Plant

In this scenario, we describe a factory using a simple ring topology.

A manufacturing plant has a complex network of machines and devices that communicate with each other to keep the production line running smoothly. To ensure that the network remains stable and reliable, the plant needs to use Turbo Ring v2 to create a fault-tolerant network by forming a ring topology.

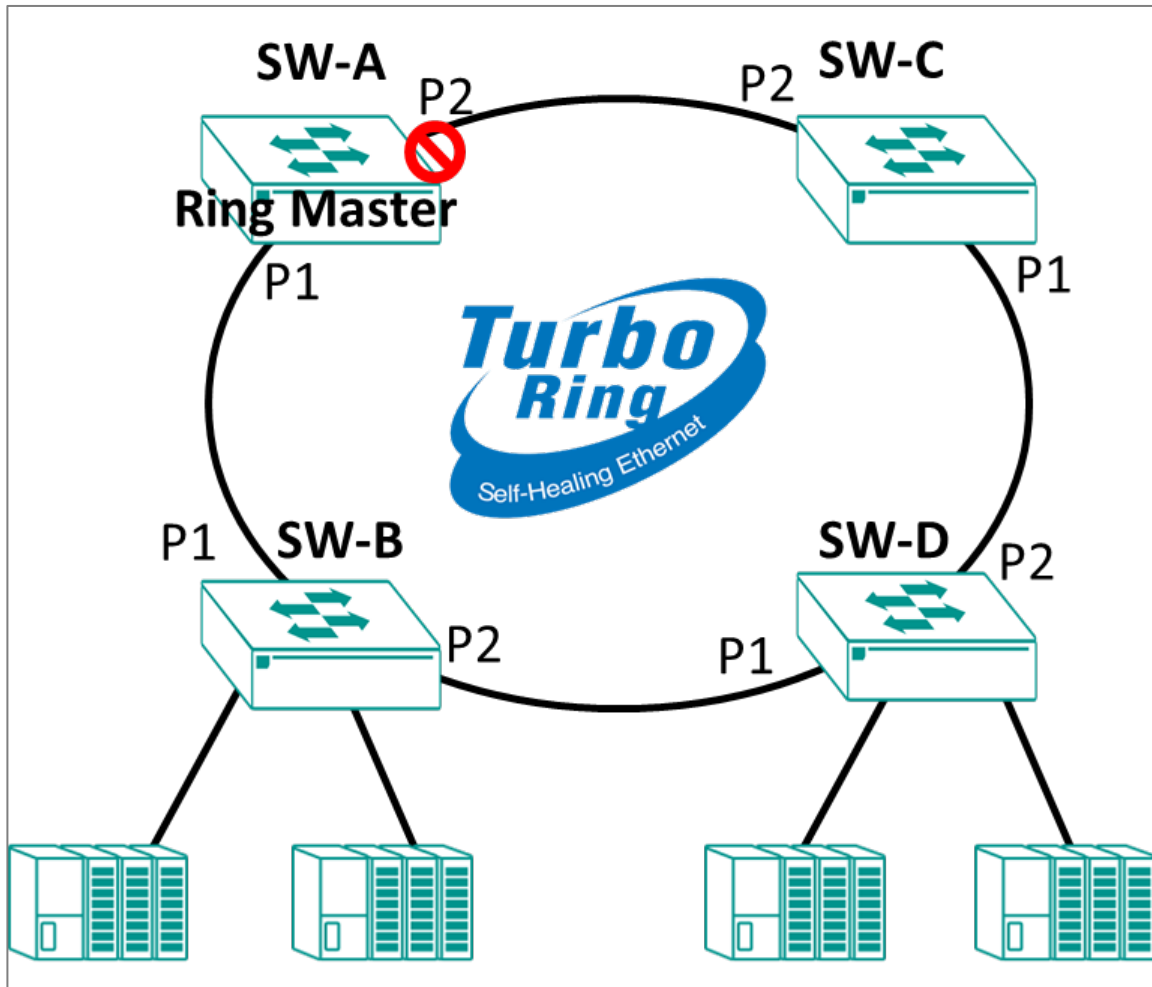

Set up Turbo Ring v2 to connect multiple networks of machines and devices to create a fault-tolerant network and achieve continuous operations.

Ensure that switches are installed and powered. Wait to connect them until the end. To configure this scenario, do the following:

1. Configure the settings each network device for Turbo Ring v2.  
See the subsequent sections for details about how to configure each device.
2. Connect the network devices in a ring topology, using ports 1 and 2 for ring segments.

If the master network device fails, the other devices in the ring will automatically detect the problem and initiate a new election process to select a new master switch, ensuring that there is no significant interruption in communication.

## Example: Configuring the Master for Turbo Ring v2 in a Manufacturing Plant

Configure the device labeled SW-A for Turbo Ring v2 in our factory example.

Make sure you have NOT connected the ring ports until after you configure Turbo Ring v2 settings. Our examples use ports **1** and **2** as ring ports.

1. Sign in to the device with administrator credentials.
2. Go to **Redundancy > Layer 2 Redundancy > Turbo Ring V2**, and then click **General**.
3. Set **Status** to **Enabled**.
4. Under Ring Settings, next to **Ring 1**, click  **[Add]**.

The Ring 1 Settings screen appears.

5. Configure all of the following:

| Option             | Value          |
|--------------------|----------------|
| <b>Status</b>      | <b>Enabled</b> |
| <b>Master</b>      | <b>Enabled</b> |
| <b>Ring Port 1</b> | <b>1</b>       |
| <b>Ring Port 2</b> | <b>2</b>       |

Setting **Master** on multiple devices (or no devices) will have the following effects:

| Master Setting                         | Result   |
|--|--|
| <b>Multiple devices set to Enabled</b> | Ring election based on MAC addresses of <b>Enabled</b> devices                                 |
| <b>No devices set to Enabled</b>       | Ring election based on MAC addresses of all devices  |
| <b>Single device set to Enabled</b>    | <b>Enabled</b> device always master, failure of <b>Enabled</b> device results in ring election |

6. Click **Apply** to save your changes.

Repeat this step on devices SW-B, SW-C, and SW-D, but with the **Master** setting set to **Disabled**. This process is outlined in the subsequent section.

## Example: Configuring non-Master devices for Turbo Ring v2 in an On-board Rail Application

Make sure you have NOT connected the ring ports until after you configure Turbo Ring v2 settings. Our examples use ports **1** and **2** as ring ports.

1. Sign in to the device with administrator credentials.
2. Go to **Redundancy > Layer 2 Redundancy > Turbo Ring V2**, and then click **General**.
3. Set **Status** to **Enabled**.
4. Under Ring Settings, next to **Ring 1**, click  **[Edit]**.

The Ring 1 Settings screen appears.

5. Configure all of the following:

| Option             | Value           |
|--------------------|-----------------|
| <b>Status</b>      | <b>Enabled</b>  |
| <b>Master</b>      | <b>Disabled</b> |
| <b>Ring Port 1</b> | <b>1</b>        |
| <b>Ring Port 2</b> | <b>2</b>        |

Setting **Master** on multiple devices (or no devices) will have the following effects:

| Master Setting                         | Result   |
|--|--|
| <b>Multiple devices set to Enabled</b> | Ring election based on MAC addresses of <b>Enabled</b> devices                                 |
| <b>No devices set to Enabled</b>       | Ring election based on MAC addresses of all devices  |
| <b>Single device set to Enabled</b>    | <b>Enabled</b> device always master, failure of <b>Enabled</b> device results in ring election |

6. Click **Apply** to save your changes.

Once all devices in the ring are configured and enabled, you can connect the ring ports.

Continue to the next section to see how to configure ring coupling. Do not connect coupling ports until network devices have been configured.

## Scenario: Using Turbo Ring in an On-board Train Application

In this scenario, we describe setting up Turbo Ring v2 with ring coupling between train consists.

A railway vehicle manufacturer needs to plan a new on-board network with redundancy and flexible inter-consist communication. The customer plans a ring network with Turbo Ring v2 between multiple vehicles to form one ring per consist. Multiple consists will then use ring coupling for inter-consist communication.

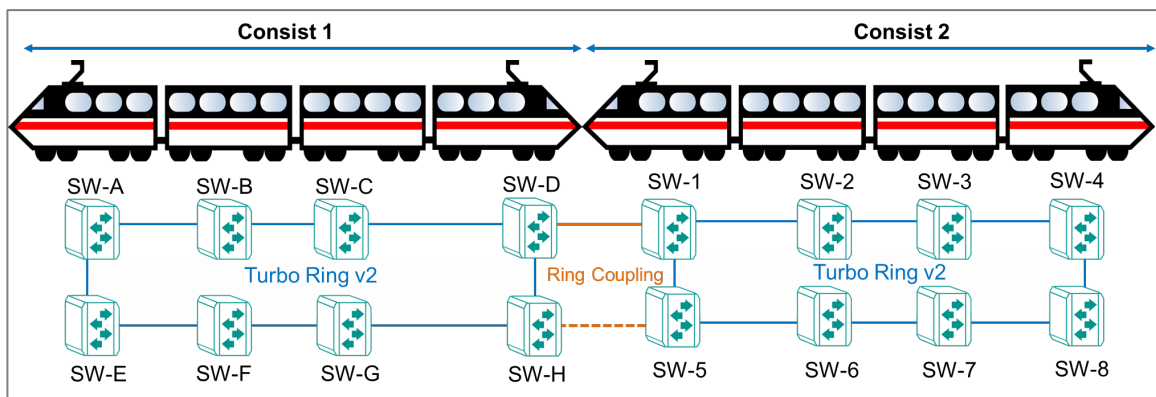

This structure allows for easy administration as consists are coupled and uncoupled.

To configure this scenario, do the following:

1. Configure the settings each network device for Turbo Ring v2.  
See the subsequent sections for details about how to configure each device.
2. Connect the network devices SW-A through SW-H in a ring topology, using ports 1 and 2 for segments of the ring. Do the same for SW-1 through SW-8. Do not connect the ring coupling yet.
3. Configure the Primary Coupling Path path on SW-D.  
See the subsequent sections for details about how to configure ring coupling.
4. Configure the Backup Ring Coupling on SW-H.  
See the subsequent sections for details about how to configure ring coupling.

Once all devices have been configured, you can connect the ring ports and coupling ports.

## Example: Configuring non-Master devices for Turbo Ring v2 in an On-board Rail Application

Make sure you have NOT connected the ring ports until after you configure Turbo Ring v2 settings. Our examples use ports and as ring ports.

1. Sign in to the device with administrator credentials.
2. Go to **Redundancy > Layer 2 Redundancy > Turbo Ring V2**, and then click **General**.
3. Set **Status** to **Enabled**.
4. Under Ring Settings, next to **Ring 1**, click  **[Edit]**.

The Ring 1 Settings screen appears.

5. Configure all of the following:

| Option             | Value           |
|--------------------|-----------------|
| <b>Status</b>      | <b>Enabled</b>  |
| <b>Master</b>      | <b>Disabled</b> |
| <b>Ring Port 1</b> | <b>1</b>        |
| <b>Ring Port 2</b> | <b>2</b>        |

Setting **Master** on multiple devices (or no devices) will have the following effects:

| Master Setting                         | Result   |
|--|--|
| <b>Multiple devices set to Enabled</b> | Ring election based on MAC addresses of <b>Enabled</b> devices                                 |
| <b>No devices set to Enabled</b>       | Ring election based on MAC addresses of all devices  |
| <b>Single device set to Enabled</b>    | <b>Enabled</b> device always master, failure of <b>Enabled</b> device results in ring election |

6. Click **Apply** to save your changes.

Once all devices in the ring are configured and enabled, you can connect the ring ports.

Continue to the next section to see how to configure ring coupling. Do not connect coupling ports until network devices have been configured.

## Example: Configuring non-Master devices for Turbo Ring v2 in an On-board Rail Application

Make sure you have NOT connected the ring ports until after you configure Turbo Ring v2 settings. Our examples use ports **1** and **2** as ring ports.

1. Sign in to the device with administrator credentials.
2. Go to **Redundancy > Layer 2 Redundancy > Turbo Ring V2**, and then click **General**.
3. Set **Status** to **Enabled**.
4. Under Ring Settings, next to **Ring 1**, click  **[Edit]**.

The Ring 1 Settings screen appears.

5. Configure all of the following:

| Option             | Value           |
|--------------------|-----------------|
| <b>Status</b>      | <b>Enabled</b>  |
| <b>Master</b>      | <b>Disabled</b> |
| <b>Ring Port 1</b> | <b>1</b>        |
| <b>Ring Port 2</b> | <b>2</b>        |

Setting **Master** on multiple devices (or no devices) will have the following effects:

| Master Setting                         | Result   |
|--|--|
| <b>Multiple devices set to Enabled</b> | Ring election based on MAC addresses of <b>Enabled</b> devices                                 |
| <b>No devices set to Enabled</b>       | Ring election based on MAC addresses of all devices  |
| <b>Single device set to Enabled</b>    | <b>Enabled</b> device always master, failure of <b>Enabled</b> device results in ring election |

6. Click **Apply** to save your changes.

Once all devices in the ring are configured and enabled, you can connect the ring ports.

Continue to the next section to see how to configure ring coupling. Do not connect coupling ports until network devices have been configured.



## Example: Configuring the Primary Ring Coupling Between Consists

Both network devices that make up the ring coupling must be configured as coupling devices.

- Make sure that you have configured both rings in the scenario.
- Do not connect the coupling ports until completing setup on both devices. Our scenario assumes port **5** will serve as coupling port.
- Couplers should only be configured on one ring. Our example uses SW-D as the primary and SW-H as the backup. Do not configure SW-1 or SW-5 as couplers.

To configure SW-D as the primary ring coupler:

1. Sign in to the device with administrator credentials.
2. Go to **Redundancy > Layer 2 Redundancy > Turbo Ring V2**, and then click **General**.
3. Under Ring Coupling Settings, click  **[Edit]**.

The Ring Coupling Settings screen appears.

4. Configure all of the following:

| Option        | Value        |
|---------------|--------------|
| Status        | Enabled      |
| Coupling Mode | Primary Path |
| Coupling Port | 5            |

5. Click **Apply** to save your changes.

The device has been configured as a primary ring coupling.

Connect the ring coupling ports. Once both devices are connected, you can move on to configuring the backup coupling.

## Example: Configuring the Backup Ring Coupling Between Consists

Both network devices that make up the backup ring coupling must be configured as coupling devices.

- Make sure that you have configured both rings in the scenario.

- Do not connect the coupling ports until completing setup on both devices. Our scenario assumes port **5** will serve as coupling port.
- Couplers should only be configured on one ring. Our example uses SW-D as the primary and SW-H as the backup. Do not configure SW-1 or SW-5 as couplers.

To configure SW-H as the backup coupler:

1. Sign in to the device with administrator credentials.
2. Go to **Redundancy > Layer 2 Redundancy > Turbo Ring V2**, and then click **General**.
3. Under Ring Coupling Settings, click  **[Edit]**.

The Ring Coupling Settings screen appears.

4. Configure all of the following:

| Option               | Value              |
|----------------------|--------------------|
| <b>Status</b>        | <b>Enabled</b>     |
| <b>Coupling Mode</b> | <b>Backup Path</b> |
| <b>Coupling Port</b> | <b>5</b>           |

5. Click **Apply** to save your changes.

The device has been configured as a backup ring coupling.

Once the device has been configured, connect the ring coupling ports. Your coupling configuration will be complete.

## About RSTP

Rapid Spanning Tree Protocol (RSTP) is an IEEE 802.1w network protocol that enhances the speed and stability of the Spanning Tree Protocol (STP).

RSTP promotes high availability and a "loop-free" topology, similar to STP, but more quickly within Ethernet networks. It provides faster convergence and is backward compatible with STP. While STP takes 30-50 seconds to converge, RSTP can achieve sub-second convergence.

For applications that require redundancy, but require use of only open-standard protocols and no proprietary protocols, RSTP is a good choice.

## How RSTP Works

Based on the original concept of the STP mode, the RSTP tree also grows from root to leaf to build a loop-free topology. This means that RSTP ensures that there is only a single active path between any two devices on an active connection. The remaining disabled connections serve as backup paths in case an active connection fails.

If you are new to STP, please refer to the IEEE 802.1D standard. As an enhancement of STP, RSTP speeds up network convergence. Rapid Spanning Tree Protocol (RSTP) includes additional information in the Bridge Protocol Data Units (BPDUs) that allow each bridge to confirm that it has taken action to prevent loops from forming when it decides to enable a link to a neighboring bridge. Adjacent bridges connect through point-to-point links allow a link without waiting to ensure that all other bridges in the network have had time to react to the change. The main benefit of RSTP is that the configuration decision is made locally, rather than network-wide. This allows RSTP to carry out automatic configuration and restore a links faster than STP. Additionally, as RSTP is a widely used protocol, Moxa equipment supports connections with switches from various vendors which support RSTP to form a redundant network architecture.

When RSTP is enabled on a network, the spanning tree algorithm automatically determines the configuration of the spanning tree. RSTP's algorithm follows these general procedures:

1. **Determining the root bridge:** The switch with the lowest bridge priority is considered the root bridge through priority competition. In case of a tie, a tiebreaker based on the MAC address is used to determine the root bridge. Specifically, the switch with the lowest MAC address is considered the root bridge. All other switches are automatically designated as non-root switches.
2. **Selecting the root port for non-root switches:** The root port is selected as the best path to the root bridge based on the root cost, which is typically determined by the bandwidth of the link. Each non-root switch has only one root port.
3. **\*\*Assigning designated ports:\*\***Each connection (segment) must have a port assigned as the designated port for forwarding traffic. The designated port is the one that sends the best BPDU on its segment.

4. **\*\*Remaining ports in blocking state:\*\***All remaining ports, including alternate ports or backup ports, are in a blocking state. These ports do not transmit data to other switches or learn MAC addresses.

### Scenario: RSTP on 4 Network Devices

In this scenario, we configure 4 network devices with RSTP.

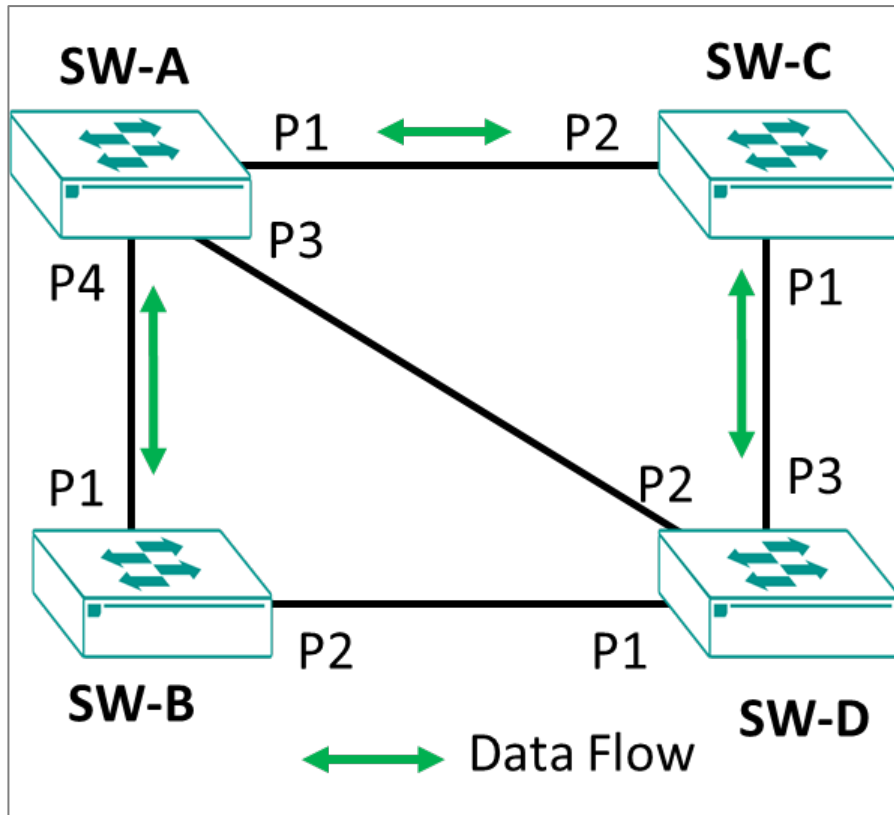

SW-A will serve as the RSTP root. SW-B, C, and D will be connected to all other devices, but use the green arrow paths as their primary data path.

Ports are configured as follows:

|                         | Device SW-A | Device SW-B | Device SW-C | Device SW-D |
|-------------------------|-------------|-------------|-------------|-------------|
| <b>Connects to SW-A</b> | N/A         | P1          | P2          | P2          |
| <b>Connects to SW-B</b> | P4          | N/A         | N/A         | P1          |
| <b>Connects to SW-C</b> | P1          | N/A         | N/A         | P3          |

|                         | Device SW-A | Device SW-B | Device SW-C | Device SW-D |
|-------------------------|-------------|-------------|-------------|-------------|
| <b>Connects to SW-D</b> | P3          | P2          | P1          | N/A         |

## Example: Configuring SW-A for RSTP

Here's how to configure SW-A as the root device for RSTP in our example.

1. Sign in to the device with administrator credentials.
2. Go to **Redundancy > Layer 2 Redundancy > Spanning Tree**, and then click **General**.
3. Set **Status** to **Enabled**.
4. Set **Bridge Priority** to **28672** to ensure that SW-A will always be set as the root.
5. Click **Apply** to save changes.
6. Locate **Port 1** on the list, and then click  **[Edit]**.

The Edit Port Settings screen appears.

7. Set **Status** to **Enabled**.
8. Click **Apply** to save changes.

The port settings will be reflected in the table.

9. Locate **Port 3** on the list, and then click  **[Edit]**.

The Edit Port Settings screen appears.

10. Click **Apply** to save changes.

The port settings will be reflected in the table.

11. Locate **Port 4** on the list, and then click  **[Edit]**.

The Edit Port Settings screen appears.

12. Click **Apply** to save changes.

The port settings will be reflected in the table.

SW-A is now configured for RSTP.

Continue to configure SW-B.

## Example: Configuring SW-B and SW-C for RSTP

Here's how to configure SW-B and SW-C for RSTP in our example.

1. Sign in to the device with administrator credentials.
2. Go to **Redundancy > Layer 2 Redundancy > Spanning Tree**, and then click **General**.
3. Set **Status** to **Enabled**.
4. Click **Apply** to save changes.
5. Locate **Port 1** on the list, and then click  **[Edit]**.

The Edit Port Settings screen appears.

6. Set **Status** to **Enabled**.
7. Click **Apply** to save changes.

The port settings will be reflected in the table.

8. Locate **Port 2** on the list, and then click  **[Edit]**.

The Edit Port Settings screen appears.

9. Click **Apply** to save changes.

The port settings will be reflected in the table.

SW-B is now configured for RSTP.

Repeat this procedure on SW-C, and then proceed to configure SW-D.

## Example: Configuring SW-D for RSTP

Here's how to configure SW-D for RSTP in our example.

1. Sign in to the device with administrator credentials.
2. Go to **Redundancy > Layer 2 Redundancy > Spanning Tree**, and then click **General**.
3. Set **Status** to **Enabled**.
4. Click **Apply** to save changes.
5. Locate **Port 1** on the list, and then click  **[Edit]**.

The Edit Port Settings screen appears.

6. Set **Status** to **Enabled**.

7. Click **Apply** to save changes.

The port settings will be reflected in the table.

8. Locate **Port 2** on the list, and then click  **[Edit]**.

The Edit Port Settings screen appears.

9. Set **Status** to **Enabled**.

10. Click **Apply** to save changes.

The port settings will be reflected in the table.

11. Locate **Port 3** on the list, and then click  **[Edit]**.

The Edit Port Settings screen appears.

12. Set Path Cost to 150000

This will ensure that this path will be preferred over the other two ports.

13. Click **Apply** to save changes.

The port settings will be reflected in the table.

SW-D is now configured for RSTP. Now that all network devices are configured, in the event that one link is severed, data will automatically flow over backup paths.

## About Turbo Chain

Turbo Chain allows flexible expansion on top of an existing topology

This allows for flexible, cost-effective expansions. This allows you to grow existing networks without replacement the main ring while still maintaining reliability and redundancy.



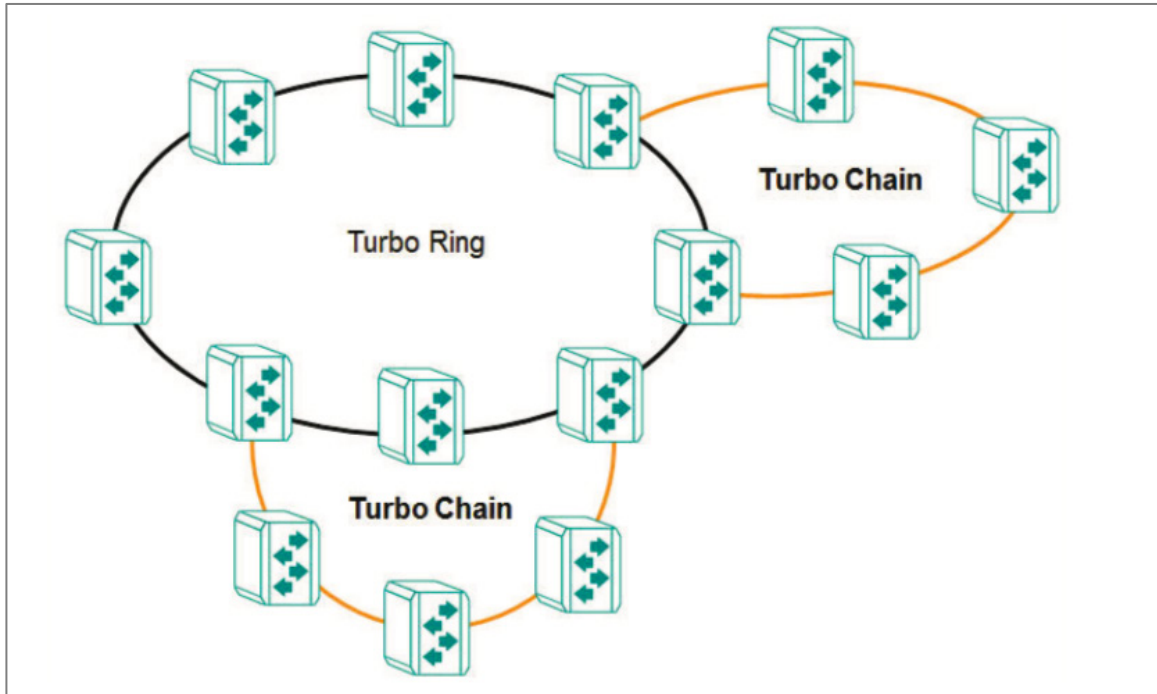

Turbo Chain is a proprietary redundancy technology developed by Moxa, designed for use in widely distributed networks. It enables Ethernet switches to be connected in a daisy-chain configuration, where each switch serves as a backup path for connected devices. Turbo Chain supports system recovery times of under 20 ms for Fast Ethernet and 50 ms for Gigabit Ethernet in member port link environments.

Turbo Chain is suitable for industrial networks with complex topologies, particularly those utilizing multi-ring architectures. It allows the creation of flexible and scalable topologies with rapid media recovery.

In a typical Turbo Chain setup, each Ethernet switch is connected to two others in a daisy-chain configuration. The switches are categorized into three types: Head, Tail, and Member switches. The Head switch connects the chain to the external network, while the Tail switch provides redundancy. If the Head port is disconnected, the Tail port immediately assumes the role of data transfer, ensuring continuous communication.

This technology ensures that in the event of a link or switch failure, Turbo Chain quickly reroutes traffic to an available backup path, minimizing network downtime and maintaining uninterrupted communication.





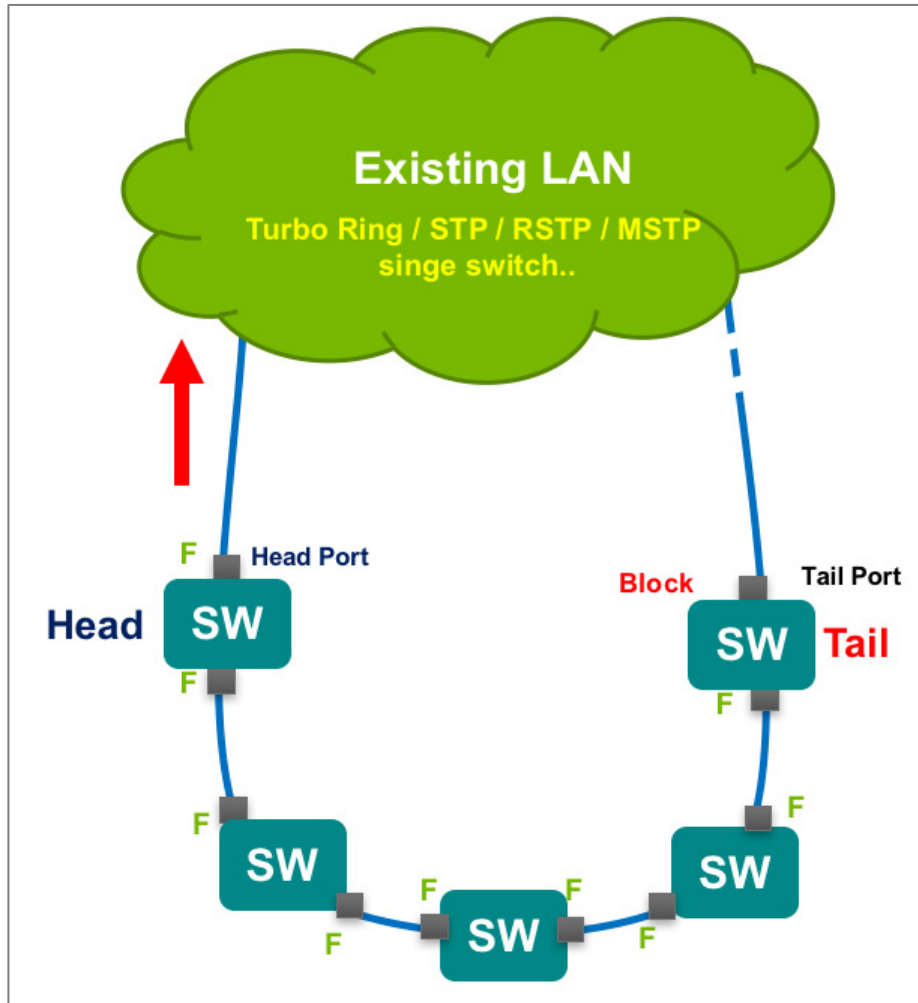

Turbo Chain is often used in industrial automation, transportation, and surveillance applications where network reliability is critical. It is compatible with other Moxa networking technologies, such as Turbo Ring, and other Redundancy protocols like STP/RSTP, MSTP etc, to provide further redundancy and resilience for industrial networks.

To sum up, here are some of the features of Turbo Chain technology:

1. **Topology:** Turbo Chain uses a daisy-chain topology to connect Ethernet switches in a loop-free configuration.
2. **Redundancy:** Turbo Chain provides a backup path on the tail switch to ensure network availability and reduce downtime in the event of a switch or link failure.
3. **Fast failover:** Turbo Chain has a fast failover mechanism that can detect and activate backup paths in a matter of milliseconds (< 20 ms) to ensure uninterrupted communication between devices.

4. **Compatibility:** Turbo Chain is compatible with other redundancy technologies, such as Turbo Ring and RSTP, to provide even greater redundancy and resilience for industrial networks.

## Example: Configuring Turbo Chain

In this example, we will configure network devices for Turbo Chain.

- Determine which devices will be the head, tail, and members of the chain. The head and tail must connect to the main LAN.
- Do not connect any of the chain devices until configuration of all devices is complete.
- Do not use any of the chain ports until configuration is completed. Do not use these ports for administration, as applying the chain configuration to these ports will disconnect you from the web GUI.

You can configure the head, tail, and member devices in any order as long as you do not connect them until after all devices are configured. Choose a device to configure and do the following:

1. Sign in to the device with administrator credentials.
2. Go to **Redundancy > Layer 2 Redundancy > Turbo Chain**, and then click **Settings**.
3. Set **Turbo Chain** to **Enabled**.
4. For **Chain Role**, specify one of the following:
  - **Head** - specify only one head of the chain. This will be the primary connection to the rest of the network.
  - **Tail** - specify only one tail of the chain. This device will be the backup connection to the rest of the network.
  - **Member** - specify one or more member devices. Member devices make up the "links" between the head and the tail of the chain. Make sure that there are no loops in the chain.
5. Specify the following Ports based on the **Chain Role**:

| Head Chain Role Option | Port Value |
|------------------------|------------|
| Head Port              | 1          |
| Member Port            | 2          |

| Member Chain Role Option | Port Value |
|--------------------------|------------|
| Member Port 1            | 1          |
| Member Port 2            | 2          |

| Tail Chain Role Option | Port Value |
|------------------------|------------|
| Tail Port              | 1          |
| Member Port            | 2          |

6. Click **Apply** to save changes.
7. Repeat this procedure to configure all devices in the chain. Once all devices have been configured, connect the devices in the chain.

Once all devices are configured and connected, packets are transmitted through the Head Port to the LAN network. If any Turbo Chain path is disconnected, the Tail Port will be activated so that packet transmission can continue.

## About VRRP

The Virtual Router Redundancy Protocol (VRRP) is a layer 3 redundancy protocol enabling multiple routers to collaborate as a group and share a virtual IP address.

The main purpose of VRRP is to provide redundancy for the default gateway utilized by hosts on a LAN or VLAN.

In a VRRP setup, a single router is designated as the "master" while the other routers are "backup" routers. The master router is responsible for forwarding packets sent to the virtual IP address. Additionally, backup routers supervise the master router and take over

its tasks in case of failure. This enables automatic failover and redundancy, guaranteeing network connectivity—even in the event of a router failure.

## Benefits of VRRP

1. **Increased Network Reliability:** VRRP enables multiple routers to work together in a group, sharing a virtual IP address. This provides redundancy for the default gateway, ensuring that network connectivity is maintained even if one of the routers fails. This increases the overall reliability of the network and helps prevent downtime.
2. **Automatic Failover:** VRRP facilitates automatic failover, where backup routers take over the tasks of the master router in case of a failure. This ensures that there is no disruption to network services and users can continue to access resources without any interruption.
3. **Easy Network Management:** VRRP simplifies network management by allowing multiple routers to work together as a group, sharing a virtual IP address. This eliminates the need for complex routing protocols and reduces the risk of misconfiguration.

## About VRRP States

With VRRP, routers are assigned different roles and states to ensure seamless failover and improved network availability.

The three primary states of VRRP are:

1. **Init State:** This is the initial state when a VRRP router starts up. The router initializes its VRRP configuration and has not yet determined whether it should become a Master or a Backup router. The router remains in the Init state until it starts receiving VRRP advertisements from other routers in the same VRRP group or until it begins sending advertisements itself.
2. **Master State:** In this state, the router is responsible for forwarding packets sent to the virtual IP address and acts as the default gateway for the devices in the network. The router with the highest priority (or lowest IP address in case of a tie) becomes the Master router. The Master router periodically sends VRRP advertisements to the other routers in the VRRP group to maintain its role. If the

Master router fails, one of the Backup routers will take over the role based on priority.

3. **Backup State:** Routers in the Backup state are waiting to take over the Master role if the current Master router fails. Backup routers listen for VRRP advertisements from the Master router and update their timers accordingly. If a Backup router stops receiving VRRP advertisements from the Master router for a certain period (typically three times the advertisement interval), it assumes that the Master router has failed and attempts to transition to the Master state based on its priority.

The VRRP states ensure that the network has a functioning default gateway at all times, providing redundancy and improving network availability in case of router failure. By implementing VRRP, network administrators can achieve increased network reliability, automatic failover, and easier network management.

## VRRP in Depth

VRRP group routers select a master router based on priority, with the highest priority being the master.

To accomplish this, Each router in the group announces its priority, and the master router regularly sends out VRRP advertisements to the other routers to update its status.

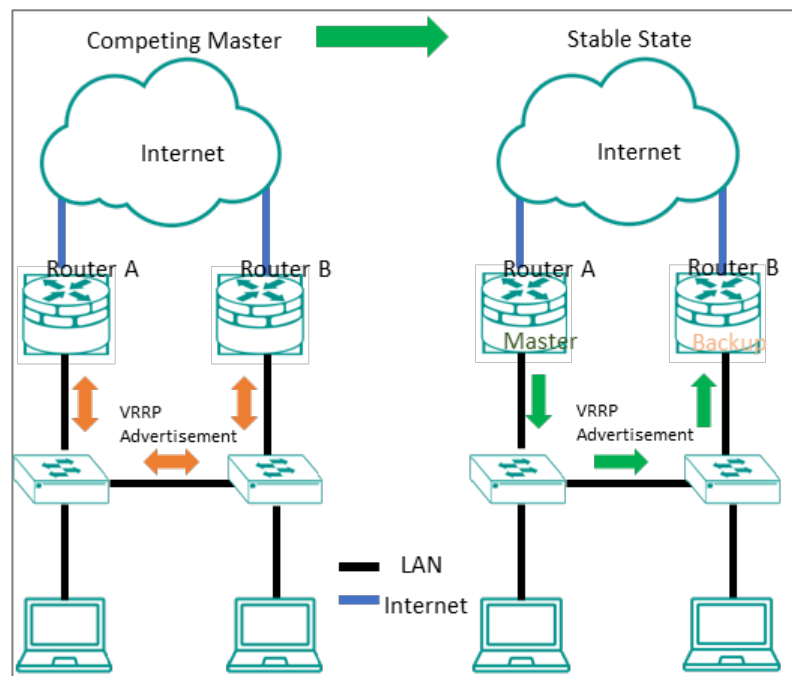

The virtual IP address is linked with the VRRP group, and the master router forwards network packets using the virtual IP address as the source address. The backup routers stay inactive, listening to the VRRP messages from the master and ready to take over if the master fails. The Master Router sends advertisement packets to the backup routers to inform them that it is still operational. The advertisement interval is manually configured, with a default value of 1 second. If the master router fails, the Backup Router is unable to receive advertisement packets from the Master. Once the advertisement down timer expires, backup router will realize that the Master is experiencing issues or has powered down and one of the backup routers with a higher priority takes over as the new master, ensuring there is no disruption in network connectivity.

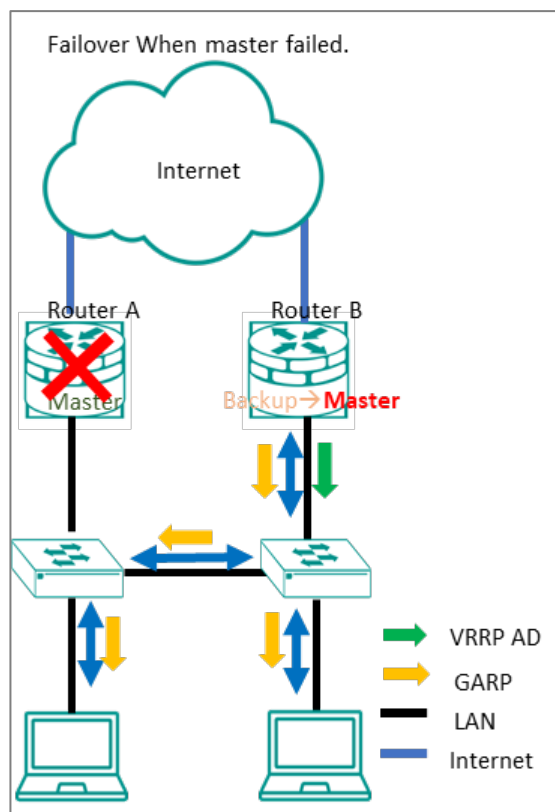

VRRP can also be set up to use preemption, which allows a higher-priority router to take over as the master even if the current master router is still functional. This can be useful when the higher-priority router is available again after a period of downtime.

In summary, VRRP is a valuable protocol that provides redundancy in network environments where high availability is critical. It enables multiple routers to act as a single virtual router, ensuring network traffic continues to flow in the event of a router failure.

## Scenario: VRRP on Two Routers

In this scenario, we'll configure two routers connected to the same LAN (Local Area Network). We will configure VRRP to ensure that if one of the routers fails, the other router will continue to forward traffic to the LAN.

For example, suppose Router A (LAN interface IP: 192.168.127.1) is initially configured as the master and Router B (LAN interface IP: 192.168.127.2) as the backup in the VRRP group. Router A is responsible for forwarding packets to the LAN. The master should keep tracking the interface by ping the device (IP 192.168.127.100) in order to make sure of the LAN communication.

If Router A were to fail by ping lost or any link down event, Router B would detect this and assume the role of the master. It would then begin forwarding packets to the LAN, ensuring that there is no disruption in network connectivity. Once Router A becomes available, it can take over as the master, and Router B reverts to its backup role.

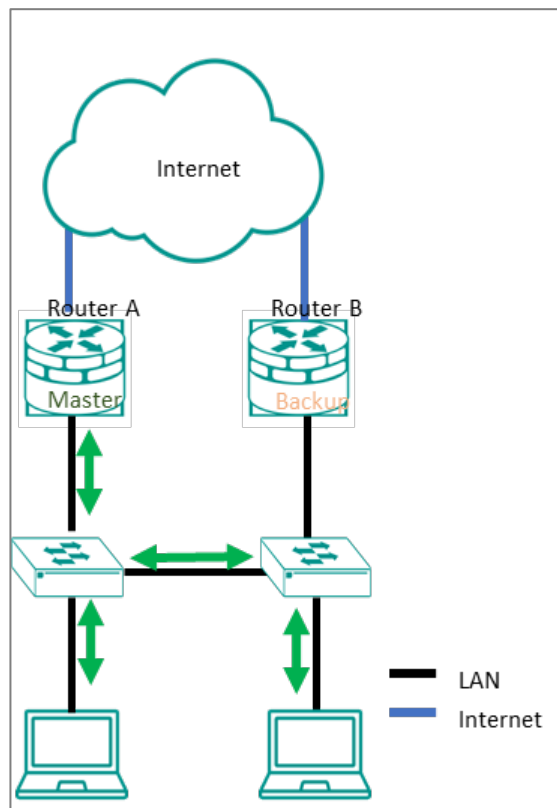

### Example: Configuring VRRP on Router A

This task assumes that each device has already configured an interface called LAN1 with the following IP addresses:

- Router A: 192.168.127.1
- Router B: 192.168.127.2

To configure Router A, do the following:

1. Sign in to the device with administrator credentials.
2. Go to **Redundancy > Layer 3 Redundancy > VRRP**, and then click **Settings**.
3. On the lower table of the screen, click **+ [Add]**.

The Create Virtual Router screen appears.

4. Configure the following, and then click **Create**.

| Option            | Value           |
|-------------------|-----------------|
| <b>Interface</b>  | LAN1            |
| <b>Virtual IP</b> | 192.168.127.3   |
| <b>Priority</b>   | 200             |
| <b>Preemption</b> | <b>Enabled</b>  |
| <b>Target IP</b>  | 192.168.127.100 |

The **Virtual Router** settings appear in the list.

5. Under the Virtual Router list, click **Apply**.
6. At the top of the page, under **VRRP**, select **Enabled** from the dropdown list, and then click **Apply**.

Router A is now configured for VRRP.

Continue to configure Router B.

### Example: Configuring VRRP on Router B

This task assumes that each device has already configured an interface called LAN1 with the following IP addresses:

- Router A: 192.168.127.1
- Router B: 192.168.127.2



To configure Router B, do the following:

1. Sign in to the device with administrator credentials.
2. Go to **Redundancy > Layer 3 Redundancy > VRRP**, and then click **Settings**.
3. On the lower table of the screen, click **+ [Add]**.

The Create Virtual Router screen appears.

4. Configure the following, and then click **Create**.

| Option            | Value           |
|-------------------|-----------------|
| <b>Interface</b>  | LAN1            |
| <b>Virtual IP</b> | 192.168.127.3   |
| <b>Priority</b>   | 100             |
| <b>Preemption</b> | <b>Enabled</b>  |
| <b>Target IP</b>  | 192.168.127.100 |

The **Virtual Router** settings appear in the list.

5. Under the Virtual Router list, click **Apply**.
6. At the top of the page, under **VRRP**, select **Enabled** from the dropdown list, and then click **Apply**.

Both routers are now configured for VRRP. In the event of a failure of one router, the other can take over using the same virtual IP address, ensuring continued function without reconfiguration.

# Routing

## About Routing

IP routing is the process of forwarding Internet Protocol (IP) traffic between different networks using one or more intermediate devices.

When one device wants to send a packet to another on a different network, it forwards the packet to its default gateway—usually a router. The router examines the destination IP address and determines the next "hop" along the path to the destination. This process continues with subsequent routers until the packet reaches its destination. Each router along the path checks its own routing table to determine the best path for the packet. Routing tables contain information about network topology and a list of networks and associated routes. Each route correlates information by destination IP or IP range, and includes information such as the next-hop router and the cost of sending packets along that route.

**Static routing** and **dynamic routing** are two methods of populating the routing table with information about how to reach different networks.

**Static routing** is manually-configured. Network administrators configure the routing table on each router. This method is simple to configure and allows packets to take predictable paths as long as network topology does not change.

**Dynamic routing** protocols automatically update the routing table on each router. This method is more flexible and scalable, making it suitable for larger and more complex networks.

In addition to how routes are configured, packets can be routed between a single sender and single recipient (**unicast**), or from one sender to multiple devices at a time (**multicast**).

**Unicast delivery** is used to send packets from one sender to one recipient, as is typically the case with most network traffic. When a device sends a packet with an unicast destination address, the router looks up the destination address in its routing table and forwards the packet to the next hop on the path to the destination.

**Multicast delivery**, on the other hand, is used to send packets from one sender to many recipients. With multicast, a single packet is sent out to a group of devices on the

network that have expressed interest in receiving packets for that group. This is useful for applications such as video streaming, where the same content needs to be sent to multiple devices simultaneously. Dynamic multicast routing protocols, such as Protocol Independent Multicast (**PIM**), are used to ensure that multicast packets are delivered only to devices that have expressed interest in receiving them.

## Routing and Packet Delivery

|                | Unicast   | Multicast            |
|----------------|---|----------------------|
| <b>Static</b>  | Manual Configuration  | Manual Configuration |
| <b>Dynamic</b> | <ul style="list-style-type: none"> <li>• <b>RIP</b></li> <li>• <b>OSPF</b></li> </ul> | <b>PIM</b>           |

### Note

The TN-4908 series currently only supports static multicast routes in multicast stream routing.

## About Static Routing

A static route is a manually configured network path used to deliver network traffic to a specific destination network or host. Unlike dynamic routes established by routing protocols, static routes are created and managed by a network administrator. They are typically used in small networks or situations where there is a limited number of destinations that need to be reached.

Among these static routes, a special type known as the default route, or 'gateway of last resort', plays a critical role. This default route, often designated as 0.0.0.0/0, represents a catch-all path. When a device doesn't have a specific route for a packet's destination IP address, it will utilize the default route, sending the data along this path. This ensures that all data, regardless of its destination, has a route to follow.

While both default and static routes are manually configured, they serve different purposes. Static routes are used for specific, predefined network paths, while the default route is a catch-all, used when no other path is available for a specific data packet. This allows for increased control over network traffic while ensuring that data can reach otherwise unspecified networks, typically including the public Internet.

Static routes, including default routes, offer several advantages, including:

- More control over network traffic, allowing administrators to direct traffic along specific paths.
- Less overhead and resource usage, as static routes don't require routers to exchange routing information.
- Faster convergence, since there are no routing updates to process.

However, static routes also have some disadvantages:

- May be time-consuming and prone to human error, as administrators must manually configure and update routes.
- Unable to adapt to network changes automatically, requiring manual intervention to update routing tables when network topology changes.
- May not scale well in large networks with numerous destinations and frequent changes.

In summary, static routing is a method for unicast communication in which network paths are manually configured by network administrators. While they offer more control over network traffic and can improve performance in some cases, static routes can be time-consuming to manage and may not be well-suited for large, dynamic networks.

## About Multicast Routing

**Multicast routing** is an efficient method for transmitting network traffic to a group of devices simultaneously. This approach helps conserve network resources, improve performance, and reduce congestion by sending only one copy of a message to all interested devices in the group.

A **Static Multicast Route** is a manually configured network path used to deliver multicast traffic to a specific group of devices on a network. It is a type of multicast route that is manually created and configured by a network administrator, rather than dynamically established by a multicast routing protocol. Static multicast routes are typically used in small networks where the multicast group membership is known and does not change frequently. They can also be used in situations where the multicast traffic needs to be routed through a specific path in the network, or when multicast traffic needs to be constrained to a specific set of network interfaces.

 **Note**

While enabling the static multicast routing, it is crucial to regularly review and adjust your configurations in response to any alterations in the network topology or multicast group memberships.

## About Selecting a Routing Protocol

**Short Description:** There are several factors to consider when selecting a routing protocol.

1. **Network Size:** In a small network with only a few L3 devices with two or three interfaces, static routing is often the simplest and most efficient option. Dynamic routing, on the other hand, is more suitable for multiple Layer 3 interfaces with many devices and complex interconnections.
2. **Topology Stability:** If the network topology is relatively stable and changes infrequently, static routing can be a reliable and predictable choice. In contrast, dynamic routing protocols like **RIP** and **OSPF** are designed to adapt to changes in the network, making them better suited for networks that are constantly changing.
3. **Operational Cost:** Static routing requires manual configuration of each router, which can be time-consuming and error-prone in large networks. Dynamic routing protocols can automate this process, making it easier to manage and scale the network.
4. **Number of Receivers:** Unicast is a one-to-one communication method, while multicast is a one-to-many communication method. Unicast is typically used for sending data to a specific recipient, while multicast is used for delivering data to multiple recipients who have expressed interest in receiving data for a specific multicast group.

 **Note**

Dynamic routing can be vulnerable to attacks that manipulate routing information.

A combination of both static and dynamic routing may also be appropriate in some cases, such as when you have a core network that uses static routes and branch networks that use dynamic routing protocols.

## Example: Adding a Static Unicast Route for Factory Automation

A factory operator wants to create static routes between two production lines to coordinate handoffs in a multistage manufacturing process. Static routes allow packets to traverse different subnets, and will ensure efficient routing of packets between the two production lines, as well as to the central control center. This also improves performance by reducing network congestion, ensuring that packets will not be retransmitted to other devices or other subnets.

**Before you begin:** Make sure you have correctly configured:

- Each device with an IP address.
- VLANs for each subnet. Refer to [VLAN](#) for more information.
- VLAN assignment to an Interface. Refer to [Network Interfaces](#) for more information.

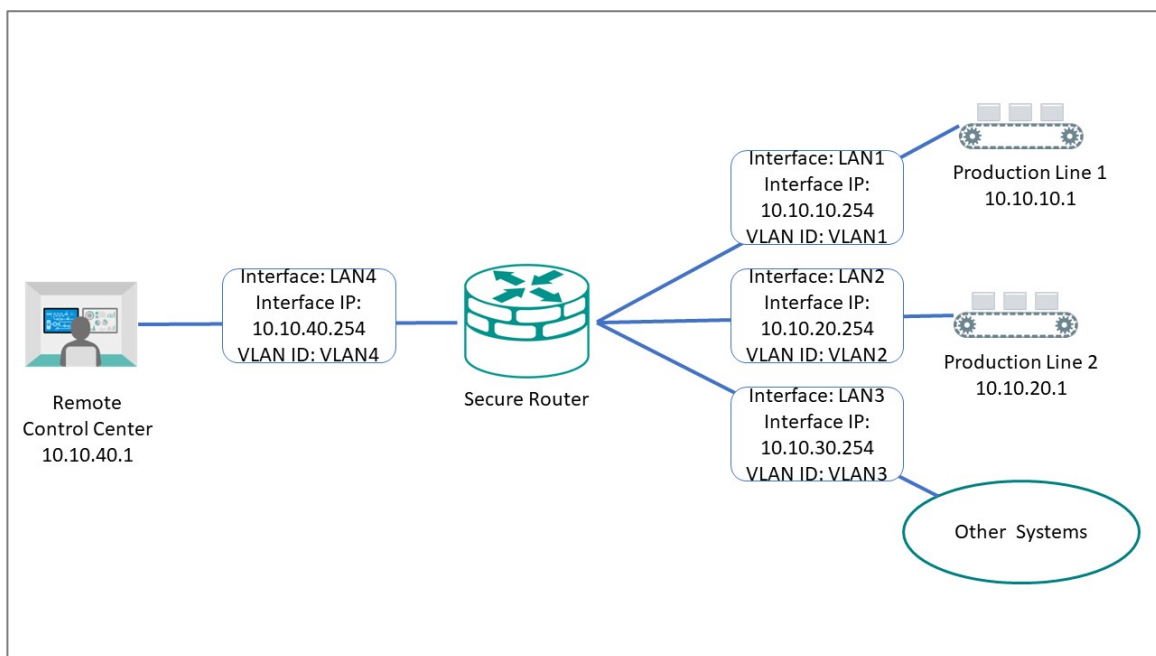

To create a static route to Production Line 1, do the following:

1. Go to **Routing**→**Unicast Route**→**Static Routes**, and then click **[Add]**.

**Result:** The **Create new static route** panel appears.

2. Specify all of the following:

| Item                       | Value   |
|----------------------------|---|
| <b>Name</b>                | Specify a name for the route. Names must not exceed 10 characters. Names are for user reference only and do not affect functionality.   |
| <b>Status</b>              | <b>Enable</b>   |
| <b>Destination Address</b> | <b>10.10.10.1</b><br>Refers to Production Line 1.   |
| <b>Subnet Mask</b>         | <b>24(255.255.255.0)</b><br>Refers to the subnet mask of the destination address.   |
| <b>Next Hop</b>            | <b>10.10.10.254</b><br>Refers to the Secure Router LAN1 Interface as the next hop on the network.   |
| <b>Metric</b>              | <b>1</b><br>Indicates the preference or priority of a particular route, with lower values having higher priority. When multiple static routes are available (or both static and dynamic routing protocols are available), the router uses the <b>Metric</b> value to determine the best route to use. For static routes, a value of 1 is recommended. |

 **Note**

The Destination Address and Subnet Mask identify which traffic forwards to the next hop. For multi-hop entries, the Subnet Mask will correspond to the Destination Address and not the Next Hop.

3. Click **Create**.

**Result:** The new static routing entry should appear in the routing table.

**Results:**

Packets meeting the destination criteria will be routed to the appropriate interface and applicable subnet, and will not be propagated further.

**What to do next:** Repeat this procedure to add Production Line 2 (10.10.20.1), the Remote Control Center (10.10.40.1), and Other Systems (10.10.30.1) to the Static Routing Table.

## Example: Adding Static Multicast Route for Passenger Speed Display

A train operator wants to display current train speed on the PIS (Passenger Information System), requiring the TCMS (Train Control Management System) to share speed information with the PIS. There are multiple displays in multiple cars throughout the train. Multicast static routing allows the TCMS to send a single packet to multiple displays across the train, minimizing traffic congestion and processing overhead. The reduction in the total number of packets on the network can make it easier to manage quality of service and allocate network resources effectively.

**Before you begin:** Make sure you have correctly configured:

- Each device with an IP address.
- Each display device to join the multicast group (239.1.1.1 in this example). Consult your PIS system documentation for details.
- VLANs for each subnet. Refer to [VLAN](#) for more information.
- VLAN assignment to an Interface. Refer to [Network Interfaces](#) for more information.
- IGMP Snooping as Enabled on the VLAN for the PIS displays. Refer to [VLAN Settings - Edit VLAN Settings](#) for more information.



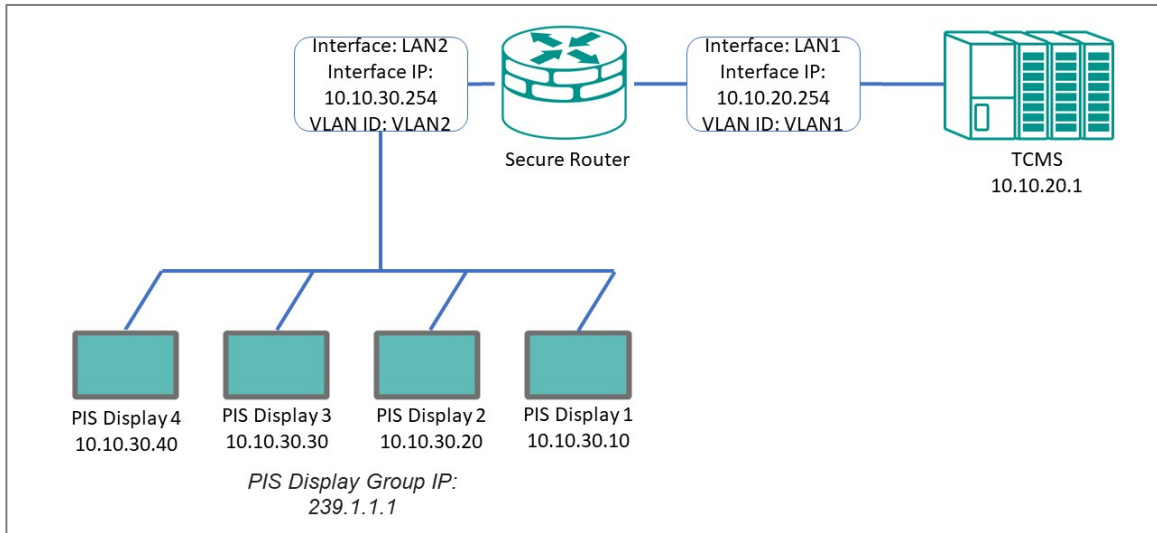

To create a static multicast route for the PIS Display Group, do the following:

1. Go to **Routing**→**Multicast Route**→**Multicast Route Settings**, make sure **Mode** is set to **Static Multicast Route**, and then click **Apply**.
2. Go to **Routing**→**Multicast Route**→**Static Multicast Route**, and then click **[Add]**.

**Result:** The **Create Static Multicast Route** panel appears.

3. Specify all of the following:

| Item                       | Value   |
|----------------------------|---|
| <b>Status</b>              | <b>Enable</b>   |
| <b>Group Address</b>       | 239.1.1.1<br>Refers to the group IP used by the PIS displays. Packets sent to this address will be sent to all devices configured to listen on this IP which also share the other parameters specified in this section. |
| <b>Source Address Type</b> | Choose <b>Specify Source</b> , and then specify 10.10.20.1<br>This refers to the Control Unit, ensuring that other potential devices on this interface and VLAN do not generate unnecessary packets and traffic.        |
| <b>Inbound Interface</b>   | <b>LAN1</b><br>Refers to the interface connecting the TCMS to the Secure Router. Since the TCMS provides the speed data for the displays.   |

| Item                      | Value   |
|---------------------------|---|
| <b>Outbound Interface</b> | <b>LAN2</b><br>Refers to the interface connecting the PIS screens to the Secure Router. |

4. Click **Create**.

**Result:** The new static routing entry appears in the routing table.

**Results:**

Multicast packets from the TCMS meeting the specified criteria will be sent to PIS screens, allowing them to display speed data without generating duplicate or extra packets that might reduce network performance.

# About OpenVPN Client

OpenVPN is an open-source software application that implements virtual private network (VPN) techniques to create secure point-to-point or site-to-site connections. It can establish a safe and encrypted tunnel between devices and a VPN server, ensuring the internet traffic remains private and secure. OpenVPN can also traverse network address translators (NAT) and firewalls, making it a versatile and powerful solution for secure communication over the Internet.

## Scenario: Using a Site-to-Site OpenVPN Tunnel

Our scenario two locations, Site A and Site B, which need to securely share resources.

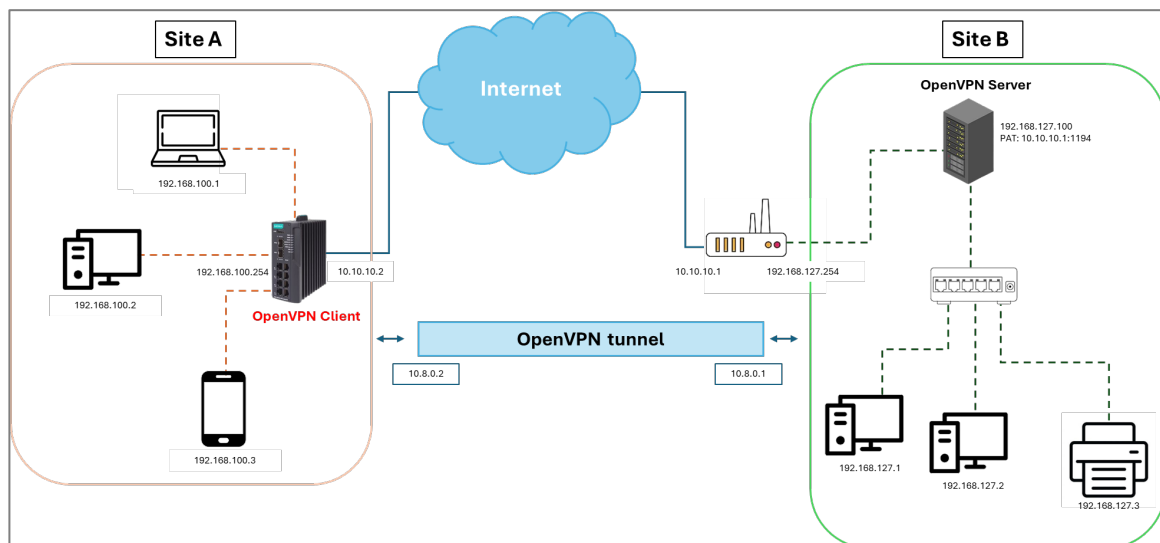

Site A has multiple devices that need access to the resources at Site B. Configuring OpenVPN on each device at Site A is complex and time-consuming. To simplify the setup, the user decides to use the router at Site A as an OpenVPN client, facilitating connections from all devices at site A to site B as though they were on the local network.

## Configuring the Router as an OpenVPN Client

Configuring the router as client allows all traffic from devices at Site A to be tunneled over the Internet to Site B as though they were on the same network.

**Before you begin:** Make sure that you have an OpenVPN Profile (.ovpn file) from the VPN server. Additionally, the router at site B must be configured with PAT (Port Address Translation) to forward OpenVPN packets to the OpenVPN server at IP address 192.168.127.100.

**Note**

Applying the OpenVPN client will disable the IPSec VPN, which may result in VPN connection loss.

1. Sign in to the device with administrator credentials.
2. Go to **VPN > OpenVPN Client > Settings**.
3. Configure all of the following:

| Option                        | Value  |
|-------------------------------|--|
| <b>Status</b>                 | <b>Enabled</b>   |
| <b>Description</b>            | Optionally enter a description of up to 40 characters. |
| <b>Import OpenVPN Profile</b> | Import an OpenVPN profile from the local file system.  |
| <b>Username</b>               | Enter a username if required by the OpenVPN server.    |
| <b>Password</b>               | Enter a password if required by the OpenVPN server.    |

4. Click **Apply** to save your settings.

**Results:** After the OpenVPN connection is established, the connection will be visible under **VPN > OpenVPN Client > Status**. Additionally, the routing information for the VPN will be visible in the routing table under **Routing > Unicast Route > Routing Table**.

**What to do next:** If the OpenVPN server cannot identify IPs from site A, it may be necessary to add a NAT rule on the OpenVPN client.

## Example: Configuring NAT to Translate over OpenVPN

For OpenVPN servers that are unable to identify IP addresses from site A, you can add a NAT rule on the OpenVPN client router.

1. Sign into the device with administrator credentials.

2. To configure the inbound rule, go to **NAT**, and then click  **[Add]**.

3. Configure all of the following:

| Option   | Value                                 |
|--|---------------------------------------|
| <b>Status</b>  | <b>Enabled</b>                        |
| <b>Description</b>                                       | Optional: Enter your description here |
| <b>Index</b>   | Specify an index (ID) for the route.  |
| <b>Mode</b>  | <b>Advance</b>                        |
| <b>Protocol</b>  | <b>ICMP, TCP, UDP</b>                 |
| <b>Incoming Interface (Original Packet)</b>              | <b>LAN</b>                            |
| <b>Source IP Mapping Type (Original Packet)</b>          | <b>Subnet Mask</b>                    |
| <b>Source IP (Original Packet)</b>                       | 192.168.100.0                         |
| <b>Subnet Mask (Original Packet)</b>                     | <b>24 (255.255.255.0)</b>             |
| <b>Source Port mapping Type (Original Packet)</b>        | <b>Any</b>                            |
| <b>Destination IP Mapping Type (Original Packet)</b>     | <b>Any</b>                            |
| <b>Destination Port Mapping Type (Original Packet)</b>   | <b>Any</b>                            |
| <b>Outgoing Interface (Translated Packet)</b>            | <b>Any</b>                            |
| <b>Source IP Mapping Type (Translated Packet)</b>        | <b>Single</b>                         |
| <b>Source IP (Translated Packet)</b>                     | 10.8.0.2                              |
| <b>Source Port Mapping Type (Translated Packet)</b>      | <b>Any</b>                            |
| <b>Destination IP Mapping Type (Translated Packet)</b>   | <b>Any</b>                            |
| <b>Destination Port Mapping Type (Translated Packet)</b> | <b>Any</b>                            |

4. Click **Apply**.

The NAT rule will appear on the list.

The router will now ensure that packets between the local network and the OpenVPN tunnel are translated to the tunnel IP address to facilitate transmission on the remote server.

# About NetFlow

NetFlow collects detailed information about the traffic passing through a network interface.

It provides network administrators with valuable insights into traffic flow within the network, allowing them to monitor and analyze network traffic effectively. This capability is crucial for performance monitoring, capacity planning, troubleshooting, and security analysis.

## NetFlow In Depth

Netflow architecture generally contains three main components.

### NetFlow Exporter

NetFlow exporters are devices that collect and export traffic data, typically a router. The exporter gathers data from the network interface, aggregates packet headers, and sends this information via UDP to the NetFlow collector for analysis.

#### Note

The exporter identifies the flows by at least one of the following features: IP Source, IP Destination, Source Port, Destination Port, Class of Service, Layer 3 Protocol Type, and Interface.

### NetFlow Collector

NetFlow collectors are servers or appliances that receive the aggregated flows transmitted by NetFlow exporters, storing and preprocessing the flow data for the NetFlow analyzer.

### NetFlow Analyzer

NetFlow analyzers are software tools designed to analyze flow data records stored by NetFlow collectors, transforming them into visual reports to aid network administrators in understanding and optimizing network performance.

# Scenario: Using NetFlow to Collect LAN Interface Data

## Data

See how NetFlow can be used to monitor an enterprise network.

In a large enterprise network, network administrators need to monitor network traffic in real time to ensure stable performance and quickly identify potential security threats. The diagram provided is a simplified example to illustrate the basic concept of NetFlow monitoring and analysis. The system consists of three main components: a NetFlow Exporter, two NetFlow Collectors for redundancy, and a NetFlow Analyzer.

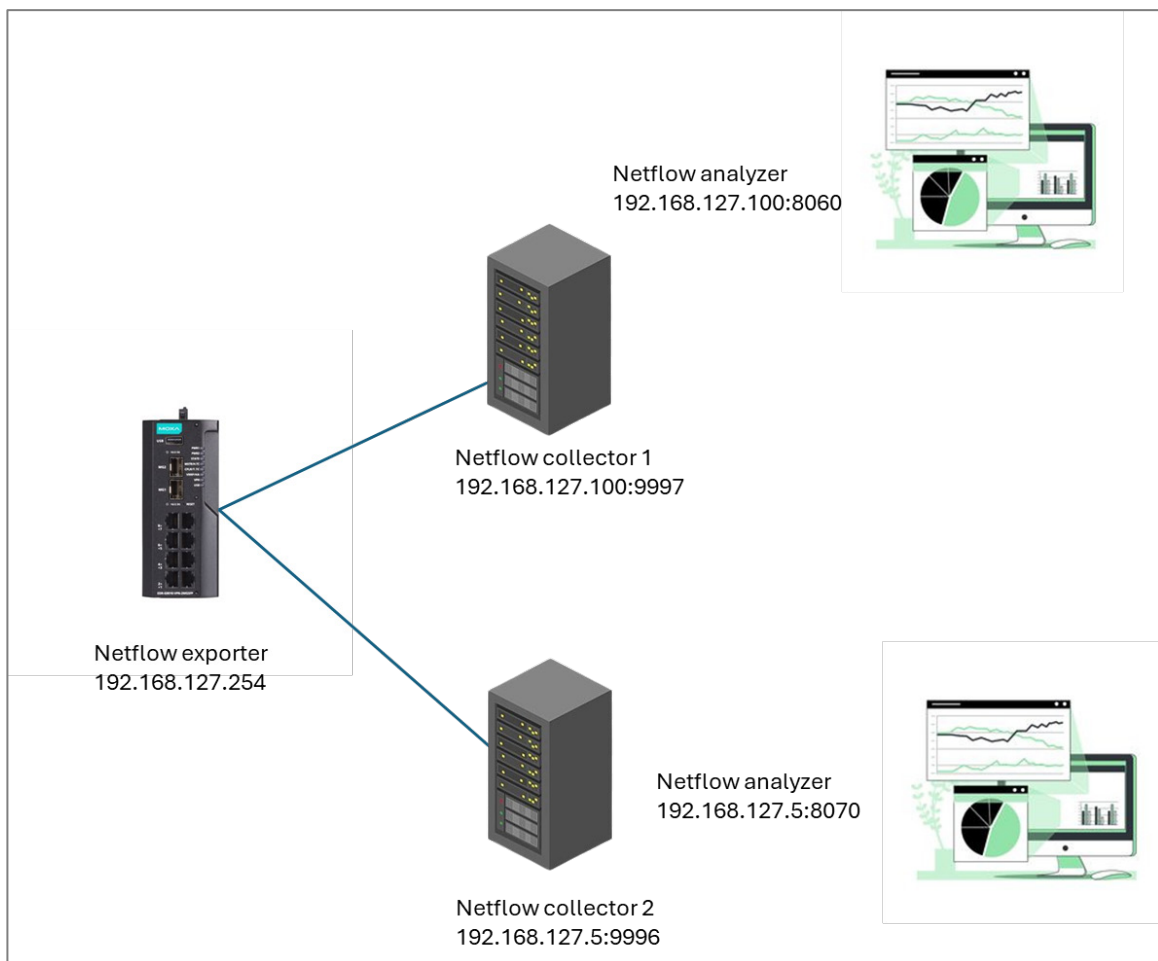

- Netflow Exporter: The router collects network traffic data from the interfaces, and sends it to two Netflow collector servers.
- 2 NetFlow Collectors (Middle Servers)



Flows will be sent to both collectors simultaneously. If one collector fails, the other will continue to operate, providing a degree of redundancy.

- NetFlow Analyzers (Software Based):
  - One NetFlow collector running **NetFlow Analyzer on Windows OS**

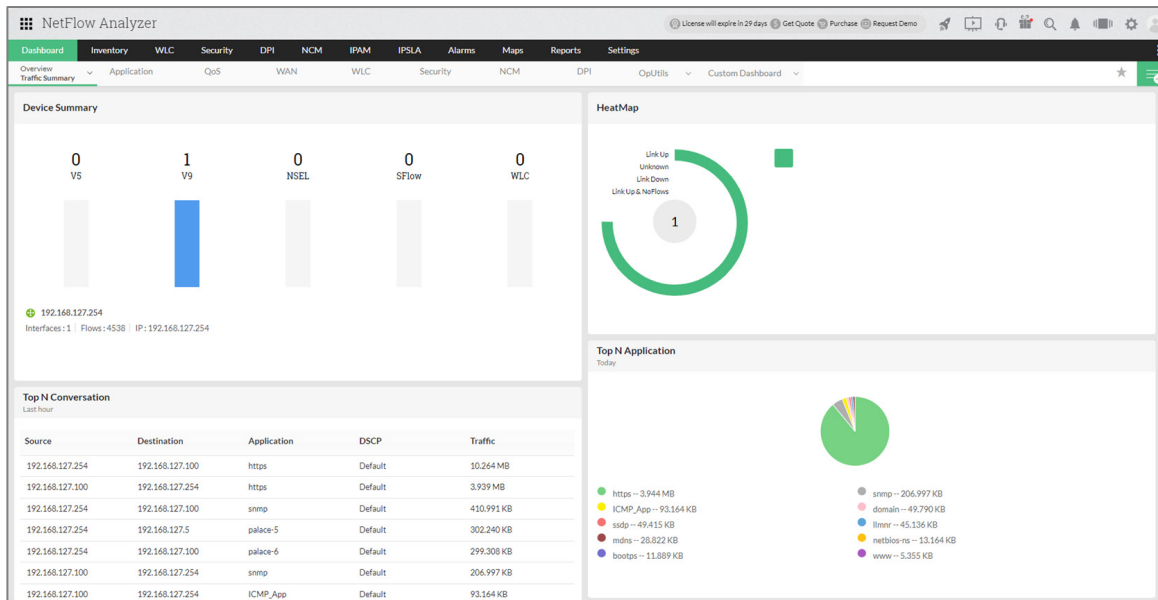

- One NetFlow collector running **NfSen on Linux**

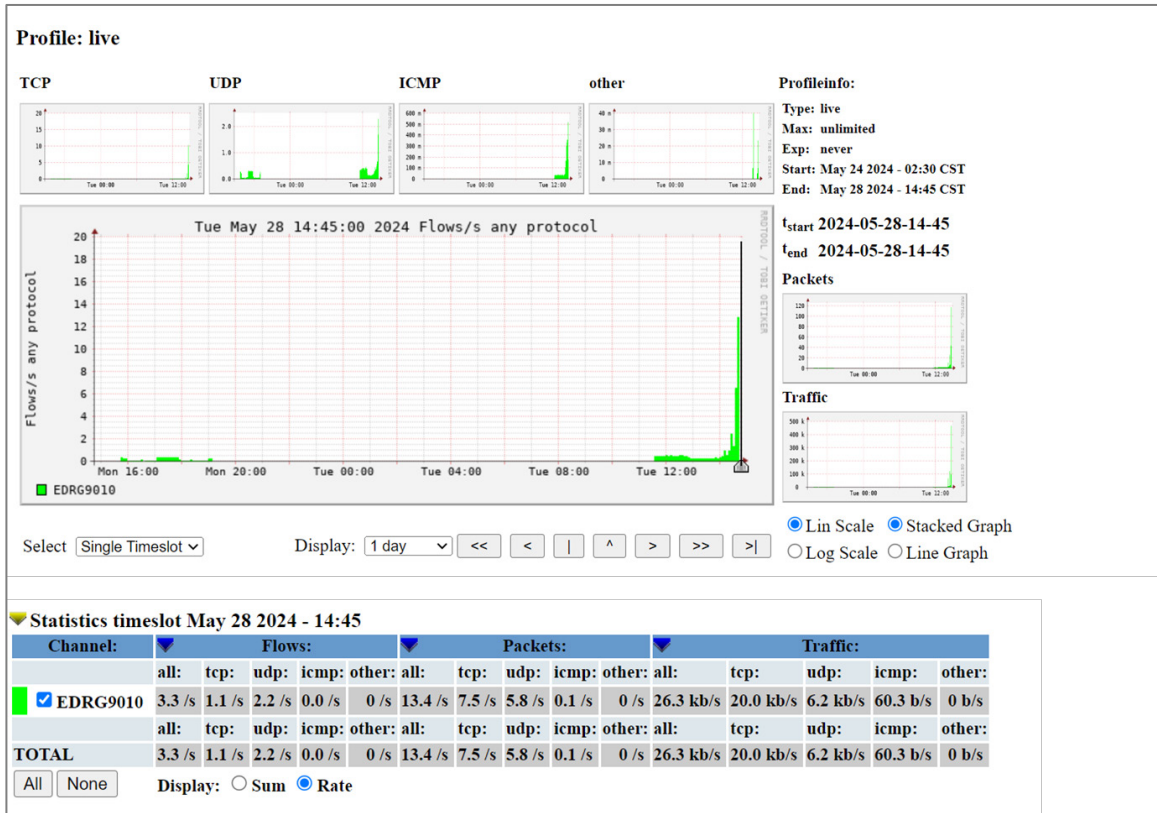

After collection, the data is sent to an analyzer. The analyzer processes this data and transforms it into visual reports, making it easier to understand and analyze network traffic patterns.

## Example: Configuring the Router as a NetFlow Exporter

To be effective in a NetFlow topology, the device must be configured as a NetFlow Exporter with the correct settings for collectors.

1. Sign in to the device using administrator credentials.
2. Go to **Diagnostics > Tools > NetFlow**.
3. To create Collector entries, next to **Collector Settings**, click **[Add]** twice.
4. Under **NetFlow Settings**, configure all of the following:

| Option         | Value          |
|----------------|----------------|
| <b>NetFlow</b> | <b>Enabled</b> |

| Option                              | Value   |
|-------------------------------------|---|
| <b>Version</b>                      | <b>V9</b> Selected the correspond NetFlow version for your NetFlow collector. |
| <b>Collector 1 IP/Host Name</b>     | 192.168.127.100   |
| <b>Collector 1 Port</b>             | 9997  |
| <b>Collector 2 IP/Host</b>          | 192.168.127.5   |
| <b>Collector 2 Port</b>             | 9996  |
| <b>Active NetFlow Entry Timeout</b> | 1   |
| <b>Inactivity Timeout</b>           | 1   |

5. Click **Apply** to apply these settings.

6. Above the table on the bottom half of the page, click  **[Add]**.

The Create NetFlow Entry screen appears.

7. Specify all of the following:

|                          |   |
|--------------------------|---|
| <b>Status</b>            | <b>Enabled</b>  |
| <b>Interface</b>         | <b>LAN</b><br>Select the network interface to be monitor by NetFlow. In this scenario, "LAN" interface (192.168.127.254/24) is selected.  |
| <b>Traffic Direction</b> | <b>Bidirectional</b>  |
| <b>Mode</b>              | <b>Basic</b><br><b>Basic</b> mode collects all data from the interface.<br><b>Filter</b> mode collects specific data flow according to source IP, source port, destination IP, destination port, and Protocol (TCP, UDP). |

**Sampling Rate****1**

This parameter defines the sampling rate of NetFlow data. When the user inputs a parameter, the system will automatically sample 1 packet from the specified number of packets as the sampling rate. For example, if the parameter is set to 100, it means that 1 packet will be randomly selected from every 100 packets as the sampling rate. The range of the sampling rate is 0~65535, the default value is 0, which means the sampling function is inactive, the result is same as sampling every packet (sampling rate = 1).

Consider the following guidelines for setting the sampling rate for a production environment:

- Low Traffic Volume: 1 per 100-500 packets
- Medium Traffic Volume: 1 per 1,000-2,000 packets
- High Traffic Volume: 1 per 2,000-4,000 packets

8. Click **Create** to save changes.

# About Loopback Interfaces

Loopback interfaces are dummy IP interfaces to allow otherwise identical subnets to communicate without address conflicts or wasted ports.

Imagine a scenario where you need to enable NAT (Network Address Translation) to traverse a VPN (Virtual Private Network). Currently, the setup requires using a Secondary IP, which needs to be bound to a physical interface. This method, although functional, consumes a physical interface and requires additional configuration. Instead, consider using a virtual interface. A virtual interface is a software-based representation of a network interface that doesn't correspond to a physical port. By using virtual interfaces, you can achieve the same objectives without consuming physical hardware resources.

## Scenario: Connecting Two Subnets

In this network topology, two routers need to establish a VPN tunnel, but their underlying LANs use the same subnet (192.168.127.0/24). This setup typically encounters difficulties because VPN tunnels cannot usually be established between two identical subnets.

A common solution to this problem is configuring a **secondary IP** address on a physical interface. However, this approach requires binding the secondary IP to an additional physical interface. If the user does not need or cannot use additional physical interfaces, this method becomes impractical.

To solve this problem, we utilized the **loopback interface** feature. Each router is configured with a loopback interface, each with a unique IP address (10.1.1.254 and 10.1.2.254). This way, the two routers can establish VPN tunnels with their respective loopback interfaces without wasting physical ports.

This configuration allows VPN tunnels to be established between two identical LAN subnets (192.168.127.0/24) by using loopback interfaces to isolate and forward internal traffic. Loopback interfaces provide an additional IP layer for the routers, allowing VPN connections to operate normally without changing the internal LAN subnet. This way, PLC#1 and PLC#2 under the LAN can communicate with the remote server (176.16.1.30) through NAT, enabling cross-subnet data exchange.

Using loopback interfaces not only solves the VPN connection issue, but also avoids the need for additional physical interfaces, making it an efficient and flexible solution.

## Sample Topology

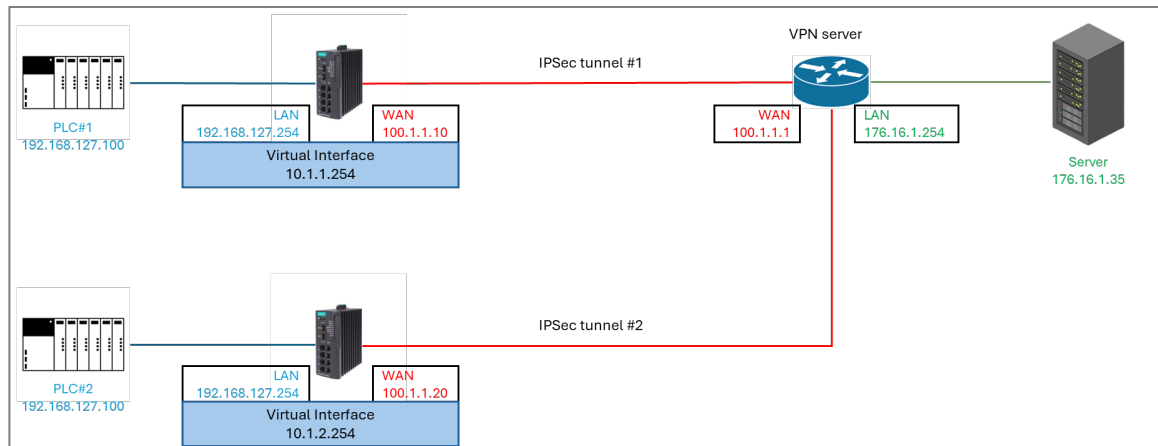

In this topology, PLC #1 and #2 both need to communicate with the server over a VPN connection. However, since they have identical local IP addresses and local subnets, their simultaneous connection would ordinarily result in IP address conflicts and routing problems. With loopback interfaces configured with unique IP addresses, this can be avoided using the loopback interface as a medium for Network Address Translation.

- The VPN tunnel is established between the 176.16.1.0/24 subnet on the server side and the 10.1.1.254/24 and 10.1.2.254/24 loopback interfaces on the routers.
- Internal LAN addresses (192.168.127.0/24) are translated via NAT to communicate through the loopback interfaces. Specifically, PLC#1 at 192.168.127.100 will be translated to 10.1.1.254, and PLC#2 will be translated to 10.1.2.254.
- PLC#1 and PLC#2 use NAT to have their traffic directed through the loopback interface, enabling seamless communication with the server at 176.16.1.254.

By utilizing loopback interfaces and NAT, the architecture ensures that even with identical LAN subnets, VPN connectivity and inter-subnet communication are maintained without the need for additional physical interfaces.

## Setup

To configure this setup, you will need:

- Loopback Interface configuration on both routers (see subsequent section)
- NAT configuration to translate the NAT (see subsequent section)

- IPsec tunnels between the VPN server(WAN IP: 100.1.1.1), Router 1 (WAN IP: 100.1.1.254), and Router 2 (WAN IP: 100.1.2.254) using the loopback interfaces as endpoints.

## Example: Configuring a Loopback Interface for IPsec Tunnel #1

Virtual interfaces need to be defined before they can be translated.

1. Sign into the device with administrator credentials.
2. Go to **Network Configuration > Network Interfaces > Virtual Interface**.
3. Under Loopback Interface, click  **[Add]**.

The Create Loopback Interface Entry screen appears.

4. Configure all of the following:

| Option            | Value   |
|-------------------|---|
| <b>Name</b>       | Specify a name. For our example, we will use VPNLoopback. |
| <b>Status</b>     | <b>Enabled</b>  |
| <b>ID</b>         | 1   |
| <b>IP Address</b> | 10.1.1.254  |
| <b>Netmask</b>    | <b>24 (255.255.255.0)</b>                                 |

5. Click **Apply**.

The loopback interface appears in the list.

Repeat this procedure on the other router to configure a loopback interface for IPsec tunnel #2 with the following differences:

- **IP Address:** 10.1.2.254

## Example: Configuring NAT to Translate to the Loopback Interface

For the Virtual Interface to be effective, NAT must be configured to correctly translate packets using the interface. Two rules must be configured on each router: an inbound rule and an outbound rule.

1. Sign into the device with administrator credentials.
2. To configure the inbound rule, go to **NAT**, and then click  **[Add]**.
3. Configure all of the following:

| Option   | Value                                 |
|--|---------------------------------------|
| <b>Status</b>  | <b>Enabled</b>                        |
| <b>Description</b>                                     | Optional: Enter your description here |
| <b>Index</b>   | Specify an index (ID) for the route.  |
| <b>Mode</b>  | <b>Advance</b>                        |
| <b>Protocol</b>  | <b>ICMP, TCP, UDP</b>                 |
| <b>Incoming Interface (Original Packet)</b>            | <b>WAN</b>                            |
| <b>Source IP Mapping Type (Original Packet)</b>        | <b>Any</b>                            |
| <b>Source Port mapping Type (Original Packet)</b>      | <b>Any</b>                            |
| <b>Destination IP Mapping Type (Original Packet)</b>   | <b>Single</b>                         |
| <b>Destination IP (Original Packet)</b>                | 10.1.1.254                            |
| <b>Destination Port Mapping Type (Original Packet)</b> | <b>Any</b>                            |
| <b>Outgoing Interface (Translated Packet)</b>          | <b>Any</b>                            |
| <b>Source IP Mapping Type (Translated Packet)</b>      | <b>Any</b>                            |
| <b>Destination IP Mapping Type (Translated Packet)</b> | <b>Single</b>                         |



| Option   | Value   |
|--|---|
| <b>Destination IP (Translated Packet)</b>                | 192.168.127.100<br>This matches the PLC on our LAN. |
| <b>Destination Port Mapping Type (Translated Packet)</b> | <b>Any</b>  |

4. Click **Apply**.

5. To configure the outbound rule, go to **NAT**, and then click  **[Add]**.

6. Configure all of the following:

| Option   | Value   |
|--|---|
| <b>Status</b>  | <b>Enabled</b>                                      |
| <b>Description</b>                                     | Optional: Enter your description here               |
| <b>Index</b>   | Specify an index (ID) for the route.                |
| <b>Mode</b>  | <b>Advance</b>                                      |
| <b>Protocol</b>  | <b>ICMP, TCP, UDP</b>                               |
| <b>Incoming Interface (Original Packet)</b>            | <b>WAN</b>  |
| <b>Source IP Mapping Type (Original Packet)</b>        | <b>Any</b>  |
| <b>Source Port mapping Type (Original Packet)</b>      | <b>Any</b>  |
| <b>Destination IP Mapping Type (Original Packet)</b>   | <b>Single</b>                                       |
| <b>Destination IP (Original Packet)</b>                | 192.168.127.100<br>This matches the PLC on our LAN. |
| <b>Destination Port Mapping Type (Original Packet)</b> | <b>Any</b>  |
| <b>Outgoing Interface (Translated Packet)</b>          | <b>Any</b>  |
| <b>Source IP Mapping Type (Translated Packet)</b>      | <b>Any</b>  |
| <b>Destination IP Mapping Type (Translated Packet)</b> | <b>Single</b>                                       |

| Option   | Value      |
|--|------------|
| <b>Destination IP (Translated Packet)</b>                | 10.1.1.254 |
| <b>Destination Port Mapping Type (Translated Packet)</b> | Any        |

7. Click **Apply**.

Repeat this procedure on the other router to configure NAT binding for IPSec Tunnel #2 and corresponding virtual interface, with the following differences:

- Inbound rule:
  - **Destination IP** (Original Packet) : 10.1.2.254
- Outbound rule:
  - **Destination IP** (Translated Packet) : 10.1.2.254

# About NAT

Network Address Translation (NAT) is a networking technique that allows multiple devices on a private network to share a single public IP address for accessing external networks, such as the internet. NAT is widely used to conserve IPv4 addresses, improve security, and provide flexibility in network design.

## NAT in Depth

NAT has two main mechanisms:

### 1. IP Address Translation:

- NAT operates on a router or gateway, translating private IP addresses (e.g., 192.168.x.x, 10.x.x.x) to a single public IP address for outbound traffic.
- Inbound traffic addressed to the public IP is translated back to the corresponding private IP.

### 2. Mapping Mechanism:

- NAT maintains a **translation table** that maps private IP addresses and ports to public IP addresses and ports.
- When an internal device initiates a connection, NAT creates an entry in this table to track the session.

## Types of NAT

### 1. NAT 1-1:

- A one-to-one mapping between private and public IP addresses.
- Commonly used for devices that require a consistent public IP, such as web servers.

### 2. NAT N-1:

- Maps private IP addresses to a pool of public IP addresses on a first-come, first-served basis.

- Useful when there are fewer public IPs than private devices.

### 3. **Port Forwarding:**

- Maps multiple private IP addresses to a single public IP by using different port numbers.
- This is the most common NAT implementation in residential and small-business networks.

## **NAT Advantages**

### 1. **Conservation of IPv4 Addresses:**

- Reduces the need for unique public IPs for each device in a private network.

### 2. **Improved Security:**

- Hides internal network structure, making it harder for attackers to directly access private devices.

### 3. **Simplified IP Management:**

- Allows the use of private IPs internally, avoiding conflicts with public IP address space.

### 4. **Flexibility in Addressing:**

- Facilitates network merging or renumbering without requiring changes to the internal IP schema.

## **Scenario: NAT for Renewable Power Generators**

A renewable energy company specializes in manufacturing tidal power generators. Each generator comes pre-installed with a set of monitoring and control devices (e.g., sensors, PLCs, and communication modules) that have identical configurations, including static IP addresses, to simplify the manufacturing process. For instance, every generator's internal devices use the same private IP scheme (e.g., 192.168.100.x).

When these generators are deployed at a tidal power farm, they are connected to a shared local network. However:

This system has the following risks:

1. IP Address Conflicts:
  - The identical IP configurations of the internal devices create conflicts when multiple generators are connected to the same network.
2. High Manual Configuration Effort:
  - Manually reconfiguring each generator's devices to assign unique IPs would be time-consuming and prone to error, especially when dealing with dozens or hundreds of generators.
3. Centralized Monitoring:
  - The company's energy management system relies on an Endpoint Detection and Response (EDR) platform to monitor and manage the networked devices. The EDR must differentiate devices across generators without altering their default configurations.

In this scenario, NAT 1-to-1 mapping can be deployed at each generator.

This approach allows the company to map the internal, identical IP ranges of each generator to unique IP ranges or subnets on the shared local network, without altering the original configurations.

See the following sections for guidelines for configuring this scenario.

## Example: Configuring 1-to-1 NAT for Device Management

You can add manual network address translation to accommodate fixed IPs on devices.

Make sure that IP interfaces have been assigned.

1. Sign in to the device with administrator credentials.
2. Go to **NAT**, and then click  **[Add]**.

The Create Index screen appears.

3. Configuring the First Device on Generator 1.
4. To add the inbound NAT rule for the first generator, specify all of the following, and then click **Apply**:

| Option  | Value         |
|---|---------------|
| <b>Mode</b>   | <b>1-to-1</b> |
| <b>Original Packet (Condition) - Incoming Interface</b> | <b>WAN</b>    |
| <b>Original Packet (Condition) - Destination IP</b>     | 10.10.0.1     |
| <b>Translated Packet (Action) - Destination IP</b>      | 192.168.100.1 |

The Index appears on the table.

- Click  **[Add]**.
- To add the outbound NAT rule for the first generator, specify all of the following, and then click **Apply**:

| Option  | Value         |
|---|---------------|
| <b>Mode</b>   | <b>1-to-1</b> |
| <b>Original Packet (Condition) - Incoming Interface</b> | <b>LAN</b>    |
| <b>Original Packet (Condition) - Destination IP</b>     | 192.168.100.1 |
| <b>Translated Packet (Action) - Destination IP</b>      | 10.10.0.1     |

The Index appears on the table.

The network device will translate between 10.10.0.1 on WAN and 192.168.100.1 without the needing to adjust the settings of the sender or the recipient, or even having them be aware that they have cross a network boundary.

To configure additional devices in this scenario, repeat the above procedure with the following differences:

| Options   | Generator 1   |               |               |               | Generator 2   |               |               |               |               |               |
|---|---------------|---------------|---------------|---------------|---------------|---------------|---------------|---------------|---------------|---------------|
|   | Device 2      |               | Device 3      |               | Device 1      |               | Device 2      |               | Device 3      |               |
|   | Inbound Rule  | Outbound Rule | Inbound Rule  | Outbound Rule | Inbound Rule  | Outbound Rule | Inbound Rule  | Outbound Rule | Inbound Rule  | Outbound Rule |
| <b>Original Packet (Condition) - Incoming Interface</b> | WAN           | LAN           | WAN           | LAN           | WAN           | LAN           | WAN           | LAN           | WAN           | LAN           |
| <b>Original Packet (Condition) - Destination IP</b>     | 10.10.0.2     | 192.168.100.2 | 10.10.0.3     | 192.168.100.3 | 10.10.0.4     | 192.168.100.1 | 10.10.0.5     | 192.168.100.2 | 10.10.0.6     | 192.168.100.3 |
| <b>Translated Packet (Action) - Destination IP</b>      | 192.168.100.2 | 10.10.0.2     | 192.168.100.3 | 10.10.0.3     | 192.168.100.1 | 10.10.0.4     | 192.168.100.2 | 10.10.0.5     | 192.168.100.3 | 10.10.0.6     |

# About L2TP

The Layer 2 Tunneling Protocol (L2TP) is a widely used tunneling protocol designed to enable virtual private networks (VPNs) and assist Internet Service Providers (ISPs) in delivering various network services.

While L2TP efficiently encapsulates data, it does not include encryption or security features on its own, making it unsuitable for transmitting sensitive information.

To support data confidentiality and protection, L2TP is often paired with Internet Protocol Security (IPSec). IPSec enhances L2TP by providing encryption and authentication. This combination—known as L2TP over IPSec—delivers a reliable VPN solution that merges L2TP’s tunneling capabilities with IPSec’s robust security.

L2TP over IPSec is ideal for remote access and client-to-site VPNs, offering an excellent balance of compatibility, scalability, and security.

## Scenario: Configuring L2TP with IPSec for Corporate VPN

A company has a centralized office network (Main Office) where critical business resources, such as servers, applications, and databases, are hosted.

Remote employees, including those working from home and traveling (Road Warriors), need secure access to the internal network .

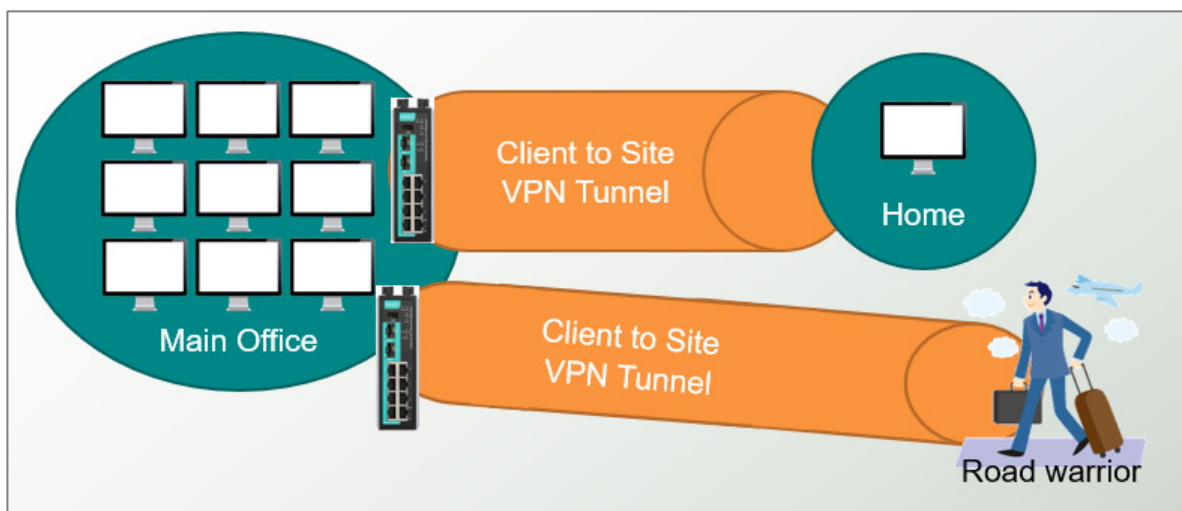



In this scenario, the Main Office VPN server uses the IP address 220.128.222.100.

The following examples outline how configure network devices to support this scenario.

## Example: Configuring L2TP Server

L2TP is the tunneling protocol that encapsulates other traffic, and must be configured before IPSec can be added.

1. Sign in to the device with administrator credentials.
2. Go to **VPN > L2TP Server**, and then click **Server Setting (WAN)**.
3. Under L2TP Server Mode, choose **Enabled** from the drop down menu.
4. Specify all of the following:

| Option                   | Value  |
|--------------------------|--|
| <b>Local IP</b>          | Specify the IP of the device. For our example, we will use 192.168.127.254 |
| <b>Offered IP: Start</b> | Specify the start of the IP range 192.168.127.1                            |
| <b>Offered IP: End</b>   | 192.168.127.100  |

5. Click **Apply** to save your changes.
6. Click **User Name Settings**, and then click  **[Add]**.  
The Create New Account for L2TP screen appears.
7. Specify a **Username** and **New Password**, and then click **Create**.

The account appears on the table.

You can now continue to configure IPSec.

## Example: Configuring IPSec for L2TP Server

IPSec can be used to add a layer of security to L2TP tunnels, providing a balance of security, convenience, and compatibility.

For L2TP/IPSec connections, L2TP must be configured before IPSec can be configured.

1. Sign in to the device with administrator credentials.
2. Go to **VPN > IPSec**, and then click **General**.

3. Under **Status**, choose **Enabled** from the drop down menu, and then click **Apply** to save your changes.

4. Click **IPSec Settings** and then click **+** **[Add]**.

The Create IPSec Connection screen appears.

5. Configure all of the following:

| Option                | Value   |
|-----------------------|---|
| <b>Settings</b>       | <b>Advanced Settings</b>                          |
| <b>Name</b>           | Specify a human-readable name for the connection. |
| <b>L2TP Tunnel</b>    | Choose <b>Enabled</b> from the drop down menu.    |
| <b>Pre-shared Key</b> | Specify a key used to encrypt traffic.            |

6. Click **Create**.

The connection appears in the table.

The connection is now ready to use. Configure the corresponding settings on the client to connect.

# About IPsec

A site-to-site IPsec VPN (Virtual Private Network) is a secure connection between two networks over the internet.

It enables organizations to connect their remote sites, such as branch offices or data centers, allowing them to communicate securely as if they were on the same local network.

In an industrial network context, using an IPsec VPN can be particularly advantageous under the following conditions:

## Remote Access to Control Systems

- **Remote Monitoring and Control:** When operators or engineers need secure access to SCADA (Supervisory Control and Data Acquisition) systems from remote locations.
- **Maintenance and Support:** If external vendors or technicians require secure access to diagnose or maintain equipment.

## Interconnecting Facilities

- **Multi-Site Operations:** For organizations with multiple manufacturing plants or facilities needing secure communication between them.

## Regulatory Compliance

- **Industry Standards:** Compliance with regulations such as NIST, IEC 62443, ISO 27001 and UR E26/E27, which often require secure communications and data protection.

## Sensitive Data Handling

- **Intellectual Property Protection:** Protecting proprietary processes or designs from unauthorized access during transmission.
- **Confidential Operational Data:** Securing sensitive operational data, including production metrics and inventory levels.

## Cybersecurity Enhancement

- **Mitigating Risks:** In environments increasingly targeted by cyber threats, such as ransomware, an IPsec VPN adds an important layer of security.
- **Segmentation:** Enhancing network segmentation to separate operational technology (OT) from IT environments securely.

## Interfacing with IoT Devices

- **Secure Communication:** Ensuring secure communication between IoT devices and centralized systems, especially when data is transmitted over public networks.

## Disaster Recovery and Backup

- **Secure Backup Transfers:** Safeguarding the transfer of backup data between sites to ensure business continuity.

## Scenario: Using IPSec to Configure Site-to-site

### VPNs

The customer operates a Modbus system and requires secure remote access to on-site equipment via the internet. To address their security concerns, the following constraints and solutions are in place:

### 1. Local Area Network (LAN) Protection:

- Many production line devices reside within a local area network (LAN).
- To safeguard these Modbus devices, direct access from the internet to the LAN is strictly prohibited.

### 2. Network Segmentation:

- A separate network zone, known as a Demilitarized Zone (DMZ), has been established to isolate internet traffic from the LAN.
- This zone serves as an intermediary to protect internal systems.

### 3. Data Transmission Security:

- All data transmitted between the DMZ and the internet must be encrypted to ensure confidentiality and integrity.
- The customer plans to implement a site-to-site VPN tunnel to secure data transfer between the remote location and the DMZ.

### 4. Access Restrictions:

- To comply with the customer's custom security policy, all access from the wide area network (WAN) to both the LAN and the DMZ is explicitly denied.

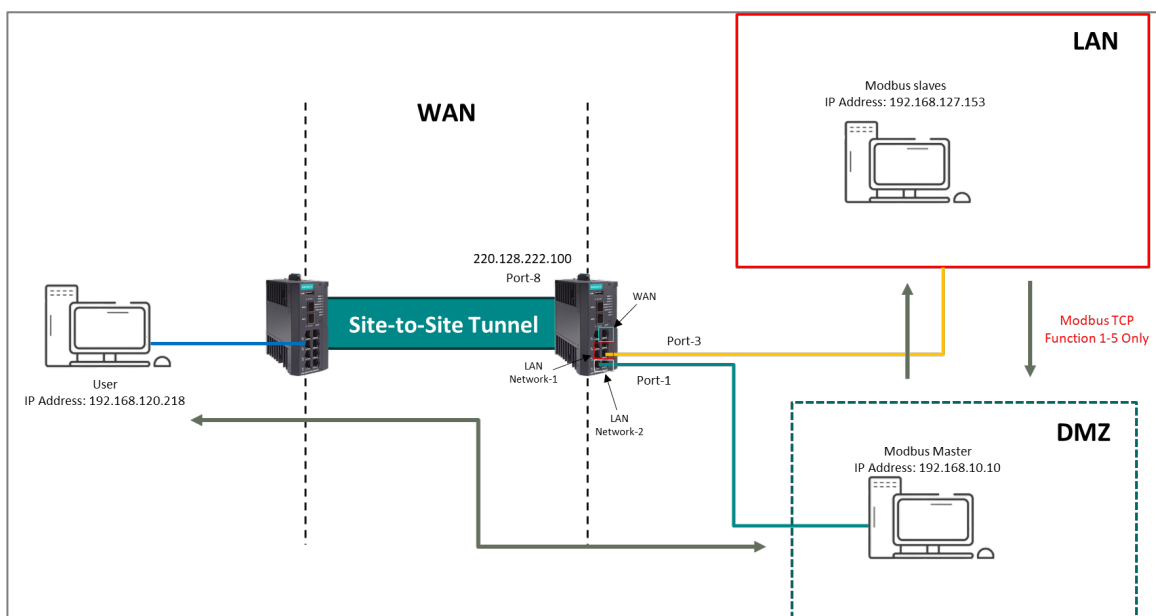

## Example: Configuring Field Site Device as a Server for Site-to-site VPN Access

1. Sign in to the device with administrator credentials.
2. Go to **VPN > IPSec**, and then click **General**.
3. Under **Status**, choose **Enabled** from the drop down menu, and then click **Apply** to save your changes.
4. Click **IPSec Settings** and then click **+ [Add]**.

The Create IPSec Connection screen appears.

5. Configure all of the following:

| Option                     | Value   |
|----------------------------|---|
| <b>Settings</b>            | <b>Advanced Settings</b>  |
| <b>Name</b>                | Specify a human-readable name for the connection.   |
| <b>VPN Connection</b>      | <b>Site to Site(Any)</b>  |
| <b>Local Network List</b>  | <ul style="list-style-type: none"> <li>• <b>Local Network:</b> 192.168.10.254</li> <li>• <b>Netmask:</b> 24 (255.255.255.0)</li> </ul>  |
| <b>Remote Network List</b> | Click <b>+ [Add]</b> , and then specify: <ul style="list-style-type: none"> <li>• <b>Remote Network:</b> 192.168.120.254</li> <li>• <b>Netmask:</b> 24 (255.255.255.0)</li> </ul> |
| <b>Pre-shared Key</b>      | Specify a key used to encrypt traffic.  |

6. Click **Create**.

The connection appears in the table.

The connection is now ready to use. Configure the corresponding settings on the remote site to connect.

## Example: Configure Remote Site Device as a Client for Site-to-site VPN Access

1. Sign in to the device with administrator credentials.

2. Go to **VPN > IPSec**, and then click **General**.
3. Under **Status**, choose **Enabled** from the drop down menu, and then click **Apply** to save your changes.
4. Click **IPSec Settings** and then click **+ [Add]**.

The Create IPSec Connection screen appears.

5. Configure all of the following:

| Option                     | Value   |
|----------------------------|---|
| <b>Settings</b>            | <b>Advanced Settings</b>  |
| <b>Name</b>                | Specify a human-readable name for the connection.   |
| <b>VPN Connection</b>      | <b>Site to Site</b>   |
| <b>Remote VPN Gateway</b>  | 220.128.222.100   |
| <b>Startup Mode</b>        | <b>Initiate Automatically</b>   |
| <b>Local Network List</b>  | <ul style="list-style-type: none"> <li>• <b>Local Network:</b> 192.168.10.254</li> <li>• <b>Netmask:</b> 24 (255.255.255.0)</li> </ul>  |
| <b>Remote Network List</b> | Click <b>+ [Add]</b> , and then specify: <ul style="list-style-type: none"> <li>• <b>Remote Network:</b> 192.168.120.254</li> <li>• <b>Netmask:</b> 24 (255.255.255.0)</li> </ul> |
| <b>Pre-shared Key</b>      | <b>Specify a key used to encrypt traffic.</b>   |

6. Click **Create**.

The connection appears in the table.

The connection is now ready to use. Configure the corresponding settings on the remote site to connect.

## Chapter 6

---

# Railway Applications



# Overview of IEC 61375 for Rail

## Applications

IEC 61375 helps operators save time and money by standardizing communication throughout a train network while minimizing configuration.

### Ease of Coupling/Decoupling

Adjusting the length of trains by coupling or decoupling consists is a common practice to optimize the economics of revenue-generating rail services. Reduction in complexity and network configuration makes train coupling/decoupling more efficient, reducing downtime of revenue-generating services. IEC 61375 streamlines the train inauguration process with the Train Topology Discovery Protocol (TTDP).

TTDP allows the operational train composition and ETB state to be stored in a Train Topology Database (TTDB), stored on each ETBN router after successful inauguration. Moxa ETBN Routers make this information accessible through a web UI, a command line interface, and Simple Network Management Protocol (SNMP). End Devices (EDs) can further utilize the Train Real-time Data Protocol (TRDP) to retrieve the train's operational status and consist information from the ETBN. TRDP-based control and monitoring service interfaces allow the configuration of leading train direction, as well as access to comprehensive train network details.

### Simplify On-board Device Communication

Train coupling involves connecting either identical or different groups of train cars, known as consists. When using equipment compliant with the IEC 61375 standard, an operational train network configuration is automatically established. This setup ensures essential services, such as TCN-DNS and R-NAT, are configured on the ETBNs (Ethernet Train Backbone Node), regardless of whether the consists are similar or disparate.

This allows onboard EDs to seamlessly send and receive messages across consists using their respective TCN-URIs, without requiring any manual network configuration adjustments within the ECN. This reduction in manual configuration time reduces the need for downtime due to network configuration issues.

## **Failover Supports Redundancy**

IEC 61375 encourages the implementation of redundant communication paths and redundant network components. Redundancy helps ensure that even if one communication path or network component fails, there is an alternative path or component available for data transmission. This enhances the overall reliability of the onboard communication network.

# Getting to Know IEC 61375

IEC 61375 is a standard that outlines Train Communication Networks (TCNs).

Issued by the International Electrotechnical Commission, IEC 61375 defines the functional requirements and architecture for Train Communication Networks to ensure interoperability between different media types in an onboard train system. Supported media types include the Multifunction Vehicle Bus (MVB), Ethernet, and wireless, among others.

Rigorous application of the standard ensures standardized communication within and between different train components, contributing to interoperability and seamless integration of systems across the train network.

For the purpose of configuring your device for a rail environment, a basic grasp of the following standards and their terminology is helpful:

- IEC 61375-2-3 - Communication Profiles
- IEC 61375-2-5 - Ethernet Train Backbones
- IEC 61375-3-4 - Ethernet Consist Networks

The following sections provide foundational knowledge of these parts.

- **[About Communication Profiles \(IEC 61375-2-3\)](#)**  
Part 2-3 defines the rules of data exchange between and within consists - known as profiles.
- **[About Ethernet Train Backbones \(IEC 61375-2-5\)](#)**  
Part 2-5 defines the backbone for communication between consists based on Ethernet.
- **[About Ethernet Consist Networks \(IEC 61375-3-4\)](#)**  
Part 3-4 defines networks within consists based on Ethernet.

## About Communication Profiles (IEC 61375-2-3)

Part 2-3 defines the rules of data exchange between and within consists - known as profiles.

Onboard application data such as Train Control and Monitoring System (TCMS) or Onboard Multimedia and Telematic Subsystems (OMTS) can take advantage of this

communication profile to facilitate interoperability/data exchange. Train Communication Networks (TCN) can leverage the following services:

## **Train Real-time Data Protocol (TRDP)**

The Train Real-time Data Protocol contains two message types:

- Message Data (MD) - Request and Reply
- Process Data (PD) - Periodical Information/Monitoring

Communication Identifiers (ComIDs) are unique identifiers that distinguish between different types of TRDP participants. They are assigned to messages to define the purpose and destination within the communication network. On Moxa devices, attributes like port numbers for PD/MD are set using an XML file loaded onto the router.

## **Train Topology Database (TTDB)**

The Train Topology Database (TTDB) contains the following four data blocks:

- Consist Info
- Train Directory
- Operational Train Directory
- Train Network Directory

Moxa routers feature a TTDB manager that reads the database and displays the current train composition. TTDB-related status can also be retrieved from the TRDP with reserved ComIDs, as well as through the web and Command-line interfaces.

## **ETB Control Service Provider (ECSP) and Client (ECSC)**

The ETB Control Service Provider (ECSP) runs on each ETBN, and controls the ETB. They ensure efficient communication and event handling. ETBs require static consist information, uploaded in the form of an XML file on Moxa ETBN routers. Refer to [Structure and Syntax of Consist Info Configuration Files](#) for more information about XML configuration files.

The ETB Control Server Client (ECSC) is a consumer or user of the control services provided by the ECSP. Typically, it communicates with the ECSP through TRDP to access

ETB control services, enabling actions like train inauguration and setting the leading direction.

## **TCN Domain Name System (TCN-DNS)**

Train Consist Network Domain Name system (TCN-DNS) focuses on domain name resolution and provides a way to help user to get operational train end device IP without pre-configured. It assists in mapping human-readable domain names to machine-readable IP addresses within the train communication environment. It supports multiple domain name resolutions via TRDP. After ECSP is configured correctly, the TCN-URI will be created automatically and available for query.

After the train inauguration process is completed, an operational train topology is established and end-device train network IP addresses are generated automatically. Certain activities—such as changing the train direction or inserting or removing a consist—will trigger dynamic regeneration of end-device train network IP addresses. TCN-DNS is advantageous because it doesn't require preconfiguration. It can automatically map URLs to IP addresses based on the train operational status.

## **TCN Uniform Resource Identifier (TCN-URI)**

The TCN Uniform Resource Identifier (TCN-URI) defines URIs for resources within the train communication network. This can include addressing schemes, identification of specific resources, or end devices for communication within the train system. TCN-URIs can be resolved by the TCN-DNS on ETB routers.

## **Safe Data Transmission (SDTv2)**

Safe Data Transmission (SDTv2) is a TRDP mechanism ensuring reliability and safety of data exchanged within the train communication network. SDTv2 offers features such as sink-time supervision, safety codes, and other error detection mechanisms to guarantee the integrity and accuracy of transmitted information.

## **IEC 61375-2-3 Terms**

IEC 61375-2-3 defines terms such as directions, orientations, and numbers in a train. These concepts can be better understood through the diagram provided below.

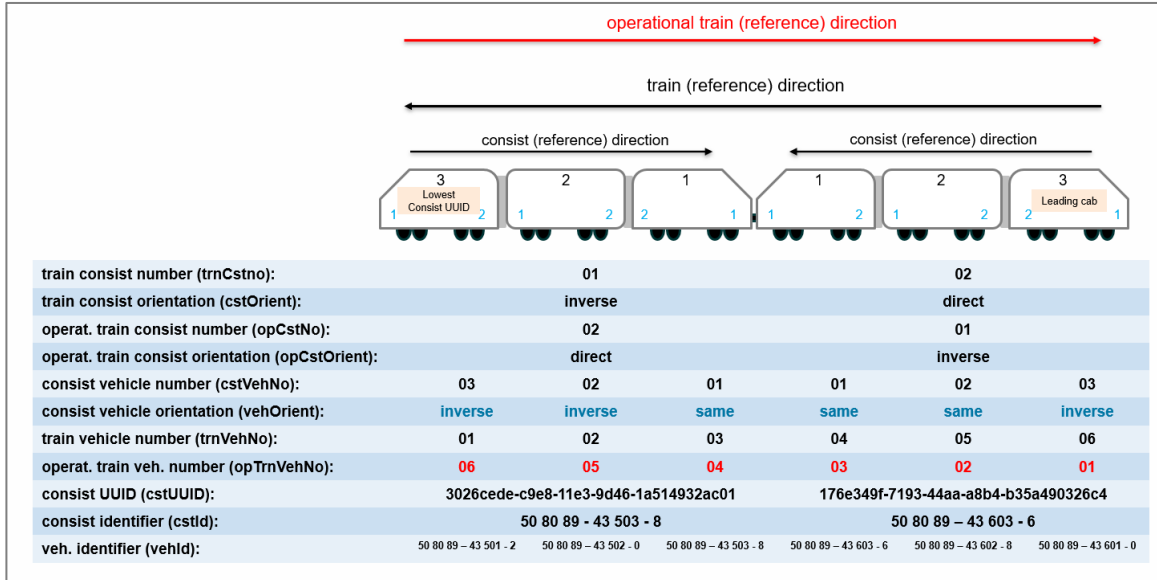

## About Ethernet Train Backbones (IEC 61375-2-5)

Part 2-5 defines the backbone for communication between consists based on Ethernet. This ensures interoperability among different network architectures. This standard consists of the follow parts:

### Ethernet Train Backbone Node (ETBN)

An ETBN is a pivotal element within the TCN, functioning as a network node that facilitates communication between subsystems and end devices within a train.

### Train Topology Discovery Protocol (TTDP)

TTDP's primary purpose is to discover the train network topology during train inauguration. TTDP plays a crucial role in maintaining situational awareness within the train communication network, allowing devices to dynamically discover the presence of neighboring devices. This capability is vital for configuring, optimizing, and troubleshooting the network, ensuring that data is transmitted efficiently and reliably between different components within the train.

## **About Ethernet Consist Networks (IEC 61375-3-4)**

Part 3-4 defines networks within consists based on Ethernet. This network utilizes Ethernet technology to enable communication within a train consist, allowing devices and systems within the train to exchange data.

### **Ethernet Device (ED)**

An Ethernet Device (ED) is a networked device that operates within a train communication system.

### **Railway-Network Address Translation (R-NAT)**

Railway-Network Address Translation (R-NAT) bridges the gap between internal and external networks. Internal train networks typically use private IP addresses that are not accessible (private, non-routable) outside the train network. R-NAT can translate these addresses to allow the ETB IP address to be used by internal devices to access external network resources. This allows internal devices to communicate with external devices, such as external railway infrastructure.

# Scenario: 2 Consists, Each with 2 Redundant ETBNs/ECSPs

In this scenario, we demonstrate an inter-consist network connection with two ETBN in each consist. Having two ETBN routers on each Consist offers enhanced networking reliability.

With the Virtual Router Redundancy Protocol (VRRP) and a redundant router, router failures can be bypassed. In this example with 2 redundant ETBN routers in each consist, in the event ETBN Router 1 fails, the ECSC on Consist 1 can still reach ED (devDoor) on Consist 2 with TCN-URI:devDoor.opVeh02.anyCst.ITrn. ETBN Router 1 will be bypassed, and ETBN router 2 will be used instead. Packets will be relayed to ETBN Router 3 and ETBN Router 4 in turn, before finally reaching the destination train network IP (10.128.128.10).

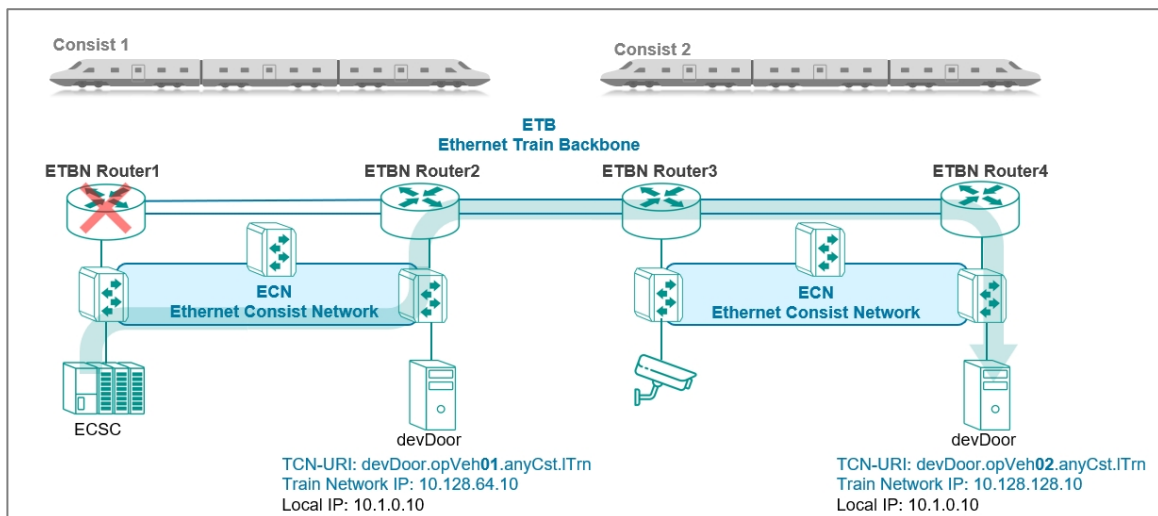

## About Traffic Flows in ETBNs

A sample of traffic flow over an ETBN using a cross-consist camera connection.

## Network Topology

In the example topology below, there are two ETBNs in each consist, and there are two consists coupled together.



The two ETBNs in each consist will negotiate to decide which will serve as primary and backup ECSPs.

The primary ECSP will do two things:

1. Act as the gateway for end device cross-subnet(consist) traffic.
2. Act as the ECSP providing ECSP functions (e.g., respond to TCN-DNS queries from other end devices.)

Let's see how the communication works when the ECSC in consist 1 wants to communicate with the camera in Consist 2.

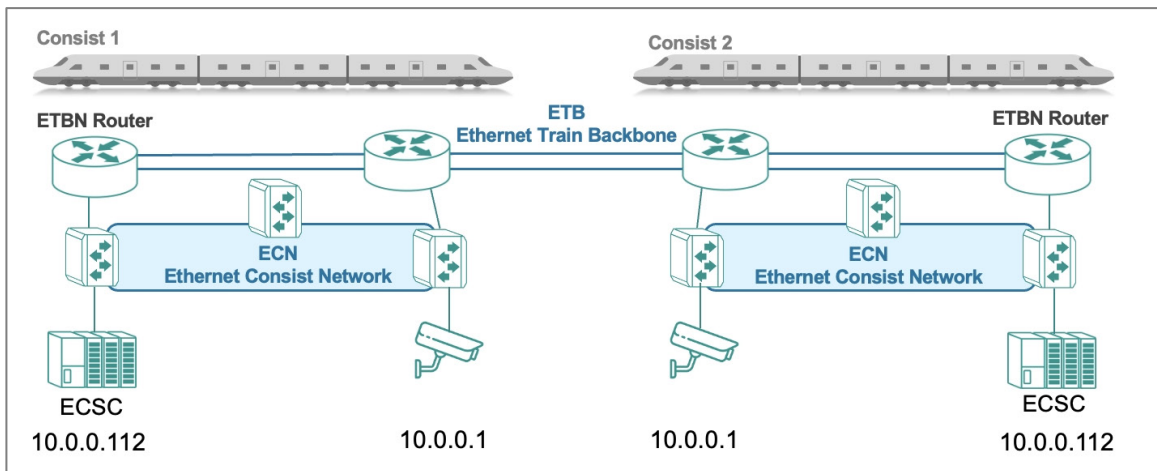

## T=0 Getting Camera IP

The ECSC in Consist 1 will ask the ECSP (ETBN router) for the Camera IP in consist 2 using TRDP(TCN-DNS). In this case, the master ECSP will respond with the global IP of the camera in consist 2 (10.128.128.1).

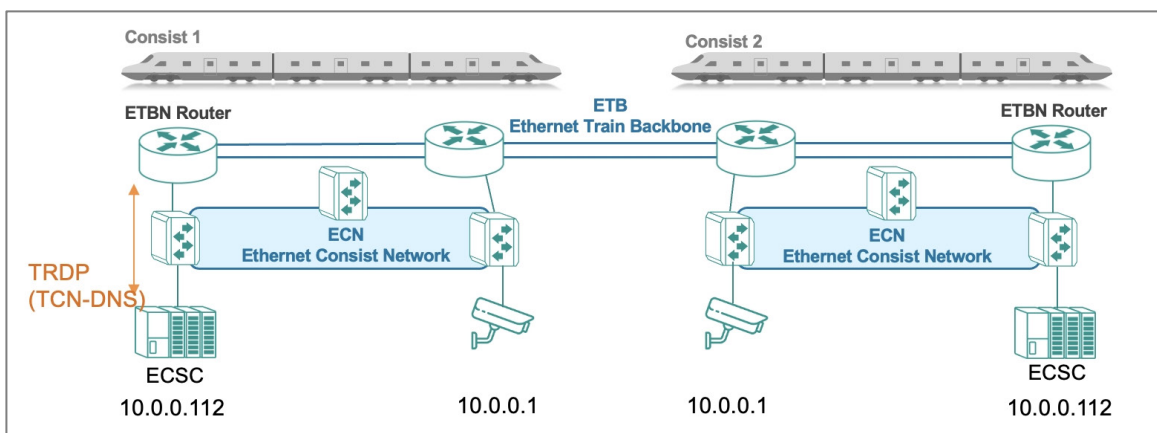

## T=1 DIP/SIP

After getting the IP of the consist 2 camera, the ECSC will send out a packet with DIP=camera IP(10.128.128.1), SIP=ECSC local IP(10.0.0.112). Because this is cross-subnet communication, the ECSC will send the packet to the default gateway (10.0.63.254, which is the virtual IP provided by the two ETBNs).

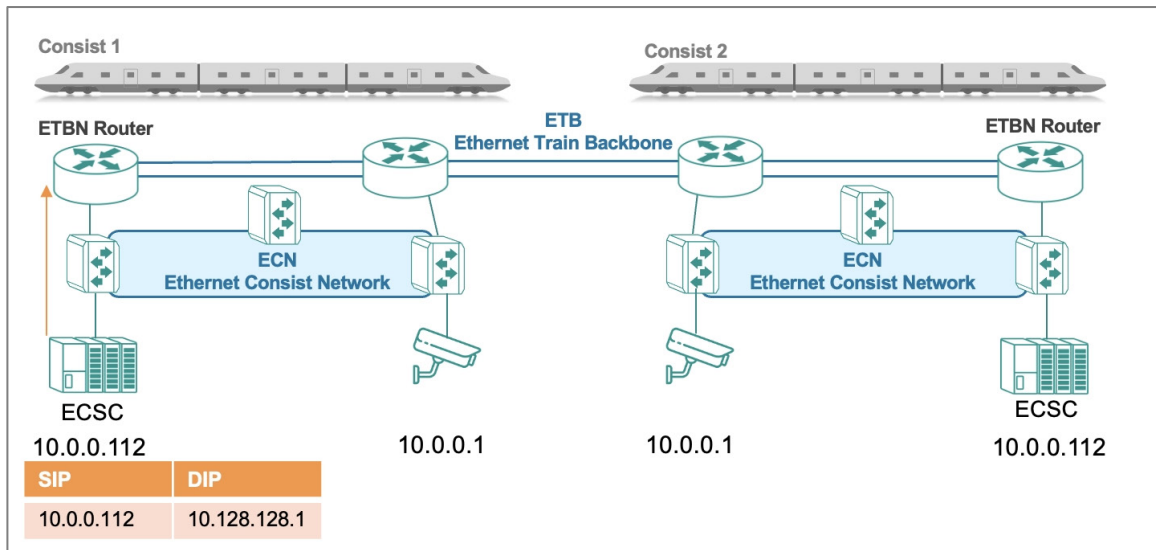

## T=2 R-NAT Translation from Consist 1

After receiving the packet, the ETBN router will translate the source IP address from Consist 1 using R-NAT, and then send it to the corresponding ETBN in Consist 2. In this case, the ETBN in Consist 1 will translate the SIP of the ECSC (10.0.0.112) to the global IP (10.128.64.112).

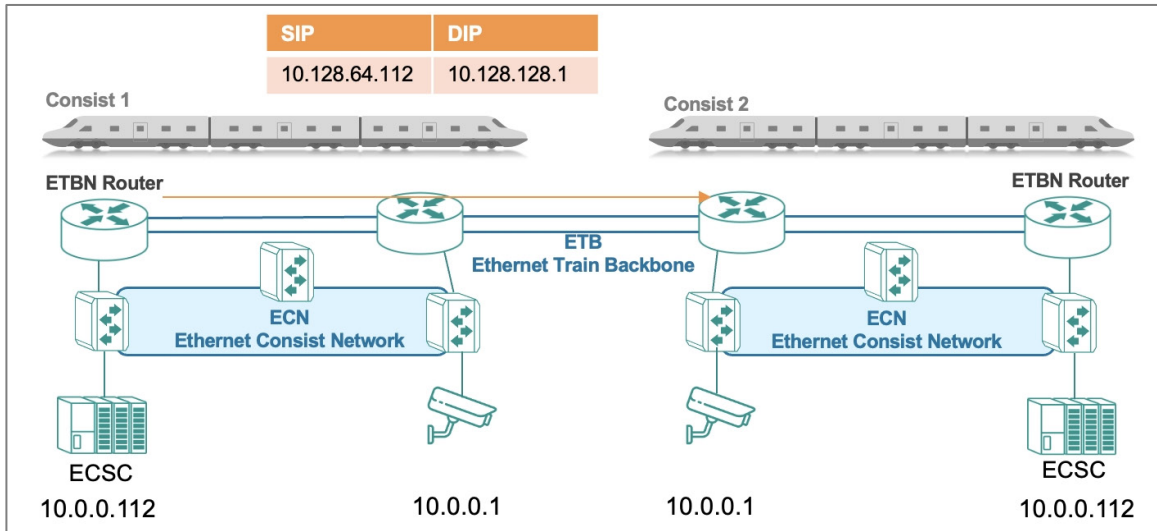

### T=3 R-NAT Translation to Consist 2

When the ETBN in Consist 2 receives the packets, it translates the destination IP address using R-NAT, and then sends them to the ECN interface. In this case, the ETBN in Consist 2 will translate the DIP of the camera (10.128.128.1) to the local IP (10.0.0.1).

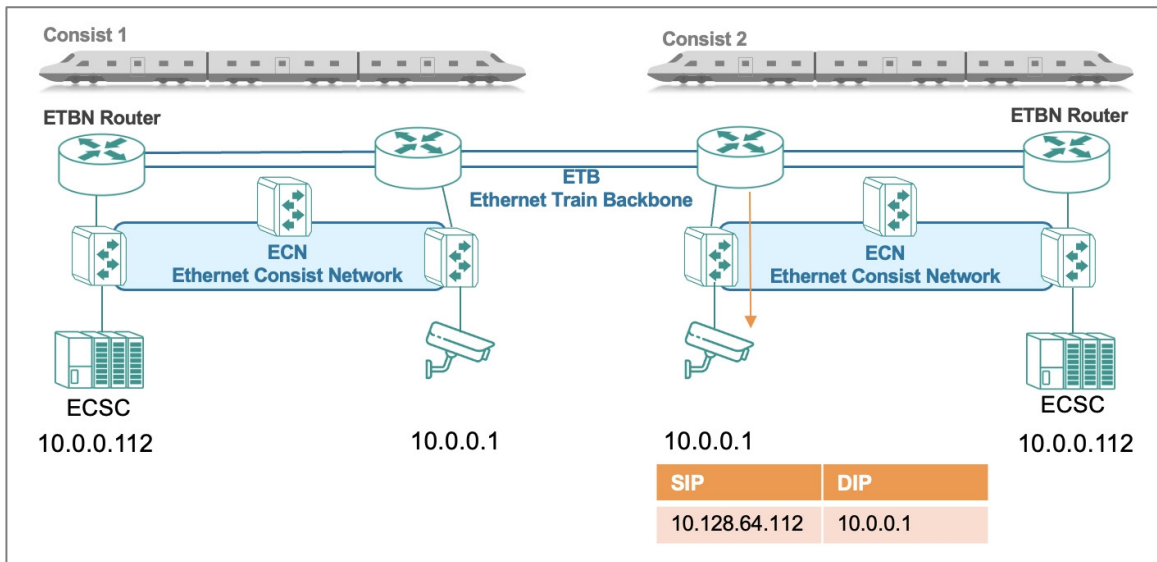

## Example: Configuring 2 Consists with 2 Redundant ETBN Routers Each

Redundant routers in each consist provide an extra layer of reliability.

- Make sure that hardware environment is ready to accommodate this topology and configuration.
- Make sure that you have correctly defined the XML configuration file required for Communication Profiles. While this tutorial provides a sample file, it only covers one consist. Refer to Structure and Syntax of Consist Info Configuration Files for more information about XML configuration files.

To configure hardware to match the example configuration with 2 Consists with 2 Redundant ETBN Routers, do the following:

1. Configure Consist 1:
  - a. Configure TTDP on ETBN router 1.  
Refer to [Example: Configuring TTDP for ETBN Router 1 on Consist 1](#) for detailed instructions.
  - b. Configure IEC 61375 Communication Profile on ETBN router 1.  
Refer to [Example: Configuring Communication Profiles for ETBNs/ECSPs](#) for detailed instructions.
  - c. Configure TTDP on ETBN router 2.  
Refer to [Example: Configuring TTDP for ETBN Router 2 on Consist 1](#) for detailed instructions.
  - d. Configure the IEC 61375 Communication Profile on ETBN router 2.  
Refer to [Example: Configuring Communication Profiles for ETBNs/ECSPs](#) for detailed instructions.
2. Configure Consist 2:
  - a. Configure TTDP on ETBN router 1.  
Refer to [Example: Configuring TTDP for ETBN Router 1 on Consist 2](#) for detailed instructions.

- b. Configure IEC 61375 Communication Profile on ETBN router 1.  
Refer to [Example: Configuring Communication Profiles for ETBNs/ECSPs](#) for detailed instructions.
- c. Configure TTDP on ETBN router 2.  
Refer to [Example: Configuring TTDP for ETBN Router 2 on Consist 2](#) for detailed instructions.
- d. Configure IEC 61375 Communication Profile on ETBN router 2.  
Refer to [Example: Configuring Communication Profiles for ETBNs/ECSPs](#) for detailed instructions.

The TTDP configuration procedure for each ETBN router is similar. The following provides a quick reference of the differences in each configuration: Table 1. Comparison of 2 Consists with 2 Redundant ETBN Routers Each

|                                 | Consist 1                            |               | Consist 2                            |               |
|---------------------------------|--------------------------------------|---------------|--------------------------------------|---------------|
|                                 | ETBN Router 1                        | ETBN Router 2 | ETBN Router 1                        | ETBN Router 2 |
| <b>Consist UUID</b>             | 00000000-0000-0000-0000-000000000001 |               | 00000000-0000-0000-0000-000000000002 |               |
| <b>Local ETBN Static ID</b>     | 1                                    | 2             | 1                                    | 2             |
| <b>ECN interface IP address</b> | 10.0.0.1                             | 10.0.0.2      | 10.0.0.1                             | 10.0.0.2      |

## Example: Configuring TTDP for ETBN Router 1 on Consist 1

Here's how to perform the GUI configuration for a 2 ETBN/ECSP sample train network.

1. Using an account with Admin authority, log in to the network device.
2. Go to **Industrial Application**→**IEC 61375**→**Ethernet Train Backbone**→**TTDP Settings**.
3. Set **TTDP Enable** to **Enabled**.
4. Under **Local Consist**, configure all of the following:

| Option                    | Description   |
|---------------------------|---|
| <b>ETB Backbone ID</b>    | <b>0</b><br>This field identifies the type of traffic carried by the ETB, and should be the same within the same ETB.<br>Since both ETBNs are in the same ETB, their ETB backbone IDs are the same. |
| <b>Consist UUID</b>       | <b>00000000-0000-0000-0000-000000000001</b><br>The UUID is the same within the same consist. The example UUID is manually assigned, but they can also be randomly generated.                        |
| <b>ETBN(s) in Consist</b> | <b>2</b><br>Dictated by our sample topology.  |
| <b>ECN(s) in Consist</b>  | <b>1</b><br>Multi-application consists might have additional ECNs to support additional applications - such as having both TCMS and Media - but our example is limited to 1 for now.                |

5. Under **Local ETBN**, configure all of the following:

| Option                      | Description  |
|-----------------------------|--|
| <b>Local ETBN Static ID</b> | <b>1</b><br>Identifies the ETBN when there are multiple ETBNs in the same consist.   |
| <b>Direction 1</b>          | <b>Trunk 1</b><br>In TN-4908, port 1,2 will be set as trunk 1, and port 5,6 will be set as trunk 2.<br>Important: The direction of all ETBNs in the same consist should be the same. |
| <b>Direction 2</b>          | <b>Trunk 2</b>   |
| <b>ETB Port Speed</b>       | <b>Auto</b>  |
| <b>ETB Port VLAN ID</b>     | <b>1000</b><br>Defines the VLAN ID of the ETB interface. The TTDP function will generate the corresponding ETB and ECN interface.  |

**Result:** Once the **Local Consist** and **Local ETBN** information is filled out, the **Add** ( + ) button will be available.

6. Click **Add (+)** to add a Consist Network.  
The **Add ECN** screen appears.

7. In the **Add ECN** screen, configure the following:

| Option                          | Description   |
|---------------------------------|---|
| <b>ECN to ETBN</b>              | <b>ETBN 1</b> and <b>ETBN 2</b>   |
| <b>ECN Port VLAN ID</b>         | 1001 <ul style="list-style-type: none"> <li>For single ECN consists, the value should be shared by all ETBNs, and should be at least 1000. ETBNs on the same VLAN should have different IP addresses.</li> <li>For multi-application consists with multiple ECNs where each ETBN handles a different ECN, the default value is 1000 + Local ETBN Static ID.</li> </ul>  |
| <b>ECN interface IP address</b> | 10.0.0.1<br><br>Defines the IP of the ECN interface. Devices in the ECN network can access the ETBN using the ECN interface IP. If you are configuring multiple ETBNs on the same VLAN, they must have different IP addresses.<br><br>Use caution when setting this as the default gateway. Because this example uses redundant ETBNs, if the primary ETBN fails and the backup takes over, the gateway IP address changes. You can avoid disruptions to cross-consist communication by leveraging VRRP. Refer to <a href="#">Redundancy &gt; Layer 3 Redundancy &gt; VRRP</a> for more information about VRRP. |
| <b>ECN Ports</b>                | <b>port3, port4, port7, and port8</b><br><br>The field is to define which ports on the TN-4900 are the ECN ports. These selected ports will be assigned to the ECN interface.   |

8. Click **Apply**.

**Results:** You have configured TTDP for ETBN 1 on Consist 1.

To finish configuring of this ETBN router, you must configure the Communication Profile by uploading an XML configuration file. Refer to [Example: Configuring Communication Profiles for ETBNs/ECSPs](#) for detailed instructions.

After configuring ETBN router 1 on Consist 1, you must configure ETBN router 2 on Consist 1, as well as ETBNs 1 and 2 on Consist 2.

This example uses 4 ETBN routers, 2 on each consist. All ETBN routers in all consists must be correctly configured before the example setup is complete.

## Example: Configuring TTDP for ETBN Router 2 on Consist 1

Here's how to perform the GUI configuration for a 2 ETBN/ECSP sample train network.

1. Using an account with Admin authority, log in to the network device.
2. Go to **Industrial Application**→**IEC 61375**→**Ethernet Train Backbone**→**TTDP Settings**.
3. Set **TTDP Enable** to **Enabled**.
4. Under **Local Consist**, configure all of the following:

| Option                    | Description   |
|---------------------------|---|
| <b>ETB Backbone ID</b>    | <b>0</b><br>This field identifies the type of traffic carried by the ETB, and should be the same within the same ETB.<br>Since both ETBNs are in the same ETB, their ETB backbone IDs are the same. |
| <b>Consist UUID</b>       | <b>00000000-0000-0000-0000-000000000001</b><br>The UUID is the same within the same consist. The example UUID is manually assigned, but they can also be randomly generated.                        |
| <b>ETBN(s) in Consist</b> | <b>2</b><br>Dictated by our sample topology.  |
| <b>ECN(s) in Consist</b>  | <b>1</b><br>Multi-application consists might have additional ECNs to support additional applications - such as having both TCMS and Media - but our example is limited to 1 for now.                |

5. Under **Local ETBN**, configure all of the following:

| Option                      | Description  |
|-----------------------------|--|
| <b>Local ETBN Static ID</b> | <b>2</b><br>Identifies the ETBN when there are multiple ETBNs in the same consist.   |
| <b>Direction 1</b>          | <b>Trunk 1</b><br>In TN-4908, port 1,2 will be set as trunk 1, and port 5,6 will be set as trunk 2.<br>Important: The direction of all ETBNs in the same consist should be the same. |



| Option                  | Description  |
|-------------------------|--|
| <b>Direction 2</b>      | <b>Trunk 2</b>   |
| <b>ETB Port Speed</b>   | <b>Auto</b>  |
| <b>ETB Port VLAN ID</b> | 1000<br><br>Defines the VLAN ID of the ETB interface. The TTDP function will generate the corresponding ETB and ECN interface. |

**Result:** Once the **Local Consist** and **Local ETBN** information is filled out, the **Add (+)** button will be available.

6. Click **Add (+)** to add a Consist Network.  
The **Add ECN** screen appears.

7. In the **Add ECN** screen, configure the following:

| Option                          | Description   |
|---------------------------------|---|
| <b>ECN to ETBN</b>              | <b>ETBN 1</b> and <b>ETBN 2</b>   |
| <b>ECN Port VLAN ID</b>         | 1001<br><br><ul style="list-style-type: none"> <li>For single ECN consists, the value should be shared by all ETBNs, and should be at least 1000. ETBNs on the same VLAN should have different IP addresses.</li> <li>For multi-application consists with multiple ECNs where each ETBN handles a different ECN, the default value is 1000 + <b>Local ETBN Static ID</b>.</li> </ul>  |
| <b>ECN interface IP address</b> | 10.0.0.2<br><br>Defines the IP of the ECN interface. Devices in the ECN network can access the ETBN using the ECN interface IP. If you are configuring multiple ETBNs on the same VLAN, they must have different IP addresses.<br><br>Use caution when setting this as the default gateway. Because this example uses redundant ETBNs, if the primary ETBN fails and the backup takes over, the gateway IP address changes. You can avoid disruptions to cross-consist communication by leveraging VRRP. Refer to <a href="#">Redundancy &gt; Layer 3 Redundancy &gt; VRRP</a> for more information about VRRP. |

| Option           | Description   |
|------------------|---|
| <b>ECN Ports</b> | <b>port3, port4, port7, and port8</b><br>The field is to define which ports on the TN-4900 are the ECN ports. These selected ports will be assigned to the ECN interface. |

8. Click **Apply**.

**Results:** You have configured TTDP for ETBN 2 on Consist 1.

To finish configuring of this ETBN router, you must configure the Communication Profile by uploading an XML configuration file. Refer to [Example: Configuring Communication Profiles for ETBNs/ECSPs](#) for detailed instructions.

After configuring ETBN router 2 on Consist 1, you must configure ETBN routers 1 and 2 on Consist 2.

This example uses 4 ETBN routers, 2 on each consist. All ETBN routers in all consists must be correctly configured before the example setup is complete.

## Example: Configuring TTDP for ETBN Router 1 on Consist 2

Here's how to perform the GUI configuration for a 2 ETBN/ECSP sample train network.

1. Using an account with Admin authority, log in to the network device.
2. Go to **Industrial Application**→**IEC 61375**→**Ethernet Train Backbone**→**TTDP Settings**.
3. Set **TTDP Enable** to **Enabled**.
4. Under **Local Consist**, configure all of the following:

| Option                 | Description   |
|------------------------|---|
| <b>ETB Backbone ID</b> | <b>0</b><br>This field identifies the type of traffic carried by the ETB, and should be the same within the same ETB.<br>Since both ETBNs are in the same ETB, their ETB backbone IDs are the same. |

| Option                    | Description  |
|---------------------------|--|
| <b>Consist UUID</b>       | 00000000-0000-0000-0000-000000000002<br>The UUID is the same within the same consist. The example UUID is manually assigned, but they can also be randomly generated.                |
| <b>ETBN(s) in Consist</b> | <b>2</b><br>Dictated by our sample topology.   |
| <b>ECN(s) in Consist</b>  | <b>1</b><br>Multi-application consists might have additional ECNs to support additional applications - such as having both TCMS and Media - but our example is limited to 1 for now. |

5. Under **Local ETBN**, configure all of the following:

| Option                      | Description  |
|-----------------------------|--|
| <b>Local ETBN Static ID</b> | <b>1</b><br>Identifies the ETBN when there are multiple ETBNs in the same consist.   |
| <b>Direction 1</b>          | <b>Trunk 1</b><br>In TN-4908, port 1,2 will be set as trunk 1, and port 5,6 will be set as trunk 2.<br>Important: The direction of all ETBNs in the same consist should be the same. |
| <b>Direction 2</b>          | <b>Trunk 2</b>   |
| <b>ETB Port Speed</b>       | <b>Auto</b>  |
| <b>ETB Port VLAN ID</b>     | <b>1000</b><br>Defines the VLAN ID of the ETB interface. The TTDP function will generate the corresponding ETB and ECN interface.  |

**Result:** Once the **Local Consist** and **Local ETBN** information is filled out, the **Add (+)** button will be available.

6. Click **Add (+)** to add a Consist Network.

The **Add ECN** screen appears.

7. In the **Add ECN** screen, configure the following:

| Option                          | Description   |
|---------------------------------|---|
| <b>ECN to ETBN</b>              | <b>ETBN 1</b> and <b>ETBN 2</b>   |
| <b>ECN Port VLAN ID</b>         | 1001 <ul style="list-style-type: none"> <li>For single ECN consists, the value should be shared by all ETBNs, and should be at least 1000. ETBNs on the same VLAN should have different IP addresses.</li> <li>For multi-application consists with multiple ECNs where each ETBN handles a different ECN, the default value is 1000 + <b>Local ETBN Static ID</b>.</li> </ul>   |
| <b>ECN interface IP address</b> | 10.0.0.1 <p>Defines the IP of the ECN interface. Devices in the ECN network can access the ETBN using the ECN interface IP. If you are configuring multiple ETBNs on the same VLAN, they must have different IP addresses.</p> <p>Use caution when setting this as the default gateway. Because this example uses redundant ETBNs, if the primary ETBN fails and the backup takes over, the gateway IP address changes. You can avoid disruptions to cross-consist communication by leveraging VRRP. Refer to <a href="#">Redundancy &gt; Layer 3 Redundancy &gt; VRRP</a> for more information about VRRP.</p> |
| <b>ECN Ports</b>                | <b>port3, port4, port7, and port8</b> <p>The field is to define which ports on the TN-4900 are the ECN ports. These selected ports will be assigned to the ECN interface.</p>   |

8. Click **Apply**.

**Results:** You have configured TTDP for ETBN 1 on Consist 1.2

To finish configuring of this ETBN router, you must configure the Communication Profile by uploading an XML configuration file. Refer to [Example: Configuring Communication Profiles for ETBNs/ECSPs](#) for detailed instructions.

After configuring ETBN router 1 on Consist 2, you must configure ETBN router 2 on Consist 2.

This example uses 4 ETBN routers, 2 on each consist. All ETBN routers in all consists must be correctly configured before the example setup is complete.

## Example: Configuring TTDP for ETBN Router 2 on Consist 2

Here's how to perform the GUI configuration for a 2 ETBN/ECSP sample train network.

1. Using an account with Admin authority, log in to the network device.
2. Go to **Industrial Application**→**IEC 61375**→**Ethernet Train Backbone**→**TTDP Settings**.
3. Set **TTDP Enable** to **Enabled**.
4. Under **Local Consist**, configure all of the following:

| Option                    | Description   |
|---------------------------|---|
| <b>ETB Backbone ID</b>    | <b>0</b><br>This field identifies the type of traffic carried by the ETB, and should be the same within the same ETB.<br>Since both ETBNs are in the same ETB, their ETB backbone IDs are the same. |
| <b>Consist UUID</b>       | <b>00000000-0000-0000-0000-000000000002</b><br>The UUID is the same within the same consist. The example UUID is manually assigned, but they can also be randomly generated.                        |
| <b>ETBN(s) in Consist</b> | <b>2</b><br>Dictated by our sample topology.  |
| <b>ECN(s) in Consist</b>  | <b>1</b><br>Multi-application consists might have additional ECNs to support additional applications - such as having both TCMS and Media - but our example is limited to 1 for now.                |

5. Under **Local ETBN**, configure all of the following:

| Option                      | Description  |
|-----------------------------|--|
| <b>Local ETBN Static ID</b> | <b>2</b><br>Identifies the ETBN when there are multiple ETBNs in the same consist.   |
| <b>Direction 1</b>          | <b>Trunk 1</b><br>In TN-4908, port 1,2 will be set as trunk 1, and port 5,6 will be set as trunk 2.<br>Important: The direction of all ETBNs in the same consist should be the same. |

| Option                  | Description  |
|-------------------------|--|
| <b>Direction 2</b>      | <b>Trunk 2</b>   |
| <b>ETB Port Speed</b>   | <b>Auto</b>  |
| <b>ETB Port VLAN ID</b> | 1000<br><br>Defines the VLAN ID of the ETB interface. The TTDP function will generate the corresponding ETB and ECN interface. |

**Result:** Once the **Local Consist** and **Local ETBN** information is filled out, the **Add (+)** button will be available.

6. Click **Add (+)** to add a Consist Network.  
The **Add ECN** screen appears.

7. In the **Add ECN** screen, configure the following:

| Option                          | Description   |
|---------------------------------|---|
| <b>ECN to ETBN</b>              | <b>ETBN 1</b> and <b>ETBN 2</b>   |
| <b>ECN Port VLAN ID</b>         | 1001<br><br><ul style="list-style-type: none"> <li>For single ECN consists, the value should be shared by all ETBNs, and should be at least 1000. ETBNs on the same VLAN should have different IP addresses.</li> <li>For multi-application consists with multiple ECNs where each ETBN handles a different ECN, the default value is 1000 + Local ETBN Static ID.</li> </ul>   |
| <b>ECN interface IP address</b> | 10.0.0.2<br><br>Defines the IP of the ECN interface. Devices in the ECN network can access the ETBN using the ECN interface IP. If you are configuring multiple ETBNs on the same VLAN, they must have different IP addresses.<br><br>Use caution when setting this as the default gateway. Because this example uses redundant ETBNs, if the primary ETBN fails and the backup takes over, the gateway IP address changes. You can avoid disruptions to cross-consist communication by leveraging VRRP. Refer to <a href="#">Redundancy &gt; Layer 3 Redundancy &gt; VRRP</a> for more information about VRRP. |

| Option           | Description   |
|------------------|---|
| <b>ECN Ports</b> | <b>port3, port4, port7, and port8</b><br>The field is to define which ports on the TN-4900 are the ECN ports. These selected ports will be assigned to the ECN interface. |

8. Click **Apply**.

**Results:** You have configured TTDP for ETBN 2 on Consist 2.

To finish configuring of this ETBN router, you must configure the Communication Profile by uploading an XML configuration file. Refer to [Example: Configuring Communication Profiles for ETBNs/ECSPs](#) for detailed instructions.

This example uses 4 ETBN routers, 2 on each consist. All ETBN routers in all consists must be correctly configured before the example setup is complete.

## Checking End-Device IPs

There are multiple ways to check the IP addresses of connected devices.

- Use an ECSP (ETB Control Service Provider) or TRDP application to query the end devices' IP with the TRDP protocol.

The screenshot shows a Wireshark interface with a capture filter for TRDP traffic. The packet list pane shows two packets:

| No.   | Time     | Source     | Destination | Info                  | Protocol               | ComId  |
|-------|----------|------------|-------------|-----------------------|------------------------|--|
| 66056 | 0.000000 | 10.0.0.112 | 10.0.0.1    | 62469 → 17225 Len=254 | TRDP - TCN DNS REQUEST | TCN-DNS - Resolving Request Telegram (query) |
| 66057 | 0.009686 | 10.0.0.1   | 10.0.0.112  | 17225 → 62469 Len=254 | TRDP - TCN DNS REPLY   | TCN-DNS - Resolving Reply Telegram           |

Using WireShark to check IP addresses.

- Use the web console to check by opening the web console, and then navigating to **IEC-61375**→**Operational Status**→**TCN-UI Table**.

**TCN-URI Table** 1970/01/22 11:03:03 

🔍 Search

| Index | TCN-URI                     | Train Network IP | Local IP   |
|-------|-----------------------------|------------------|------------|
| 1     | grpAll.aVeh.aCst.ITrn       | 239.193.0.0      |            |
| 2     | grpAll.aVeh.ICst.ITrn       | 239.194.0.0      |            |
| 3     | devECSC.opVeh01.anyCst.ITrn | 10.128.64.112    | 10.0.0.112 |
| 4     | devsw1.opVeh01.anyCst.ITrn  | 10.128.64.101    | 10.0.0.101 |
| 5     | devsw2.opVeh01.anyCst.ITrn  | 10.128.64.102    | 10.0.0.102 |
| 6     | grpDoor.aVeh.aCst.ITrn      | 239.193.0.20     |            |
| 7     | grpDoor.aVeh.ICst.ITrn      | 239.194.0.20     |            |
| 8     | grpDoor.aVeh.opCst01.ITrn   | 239.194.1.20     |            |
| 9     | devECSC.opVeh02.anyCst.ITrn | 10.128.128.111   | 10.0.0.111 |
| 10    | devsw3.opVeh02.anyCst.ITrn  | 10.128.128.103   | 10.0.0.103 |
| 11    | devsw4.opVeh02.anyCst.ITrn  | 10.128.128.104   | 10.0.0.104 |

## Getting ECSP Data with a Network Analyzer

Get train orientation, topology, and set leading direction with ECSP using a Network Analyzer.



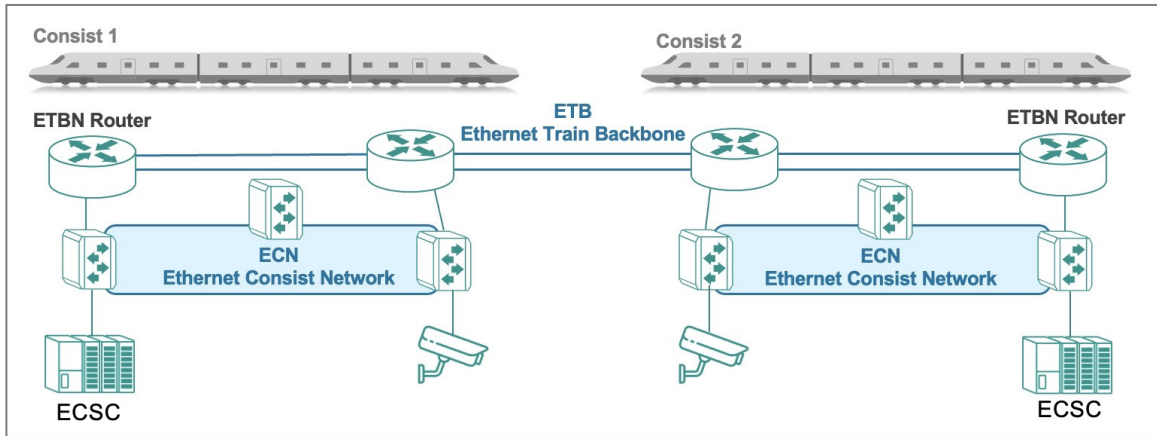

In our example with 2 consists with 2 ETBNs each, users can use ECSC or the TRDP application to query the ETB information or control the ECSP with the TRDP protocol. Here are some example uses:

- Get train topology information.  
The ECSP (10.0.0.1) periodically sends out TTDB updates on IP 239.194.0.0. Users can use the TRDP application to get TTDB information.

| No.  | Time     | Source   | Destination | Info                  | Protocol           | ComId  |
|------|----------|----------|-------------|-----------------------|--------------------|--|
| 22   | 0.000000 | 10.0.0.1 | 239.194.0.0 | 33853 + 17224 Len=112 | TRDP - TTDB STATUS | TTDB - Operational Train Directory Status Telegram |
| 169  | 1.000452 | 10.0.0.1 | 239.194.0.0 | 33853 + 17224 Len=112 | TRDP - TTDB STATUS | TTDB - Operational Train Directory Status Telegram |
| 317  | 0.991593 | 10.0.0.1 | 239.194.0.0 | 33853 + 17224 Len=112 | TRDP - TTDB STATUS | TTDB - Operational Train Directory Status Telegram |
| 491  | 1.001417 | 10.0.0.1 | 239.194.0.0 | 33853 + 17224 Len=112 | TRDP - TTDB STATUS | TTDB - Operational Train Directory Status Telegram |
| 638  | 1.000492 | 10.0.0.1 | 239.194.0.0 | 33853 + 17224 Len=112 | TRDP - TTDB STATUS | TTDB - Operational Train Directory Status Telegram |
| 786  | 1.002041 | 10.0.0.1 | 239.194.0.0 | 33853 + 17224 Len=112 | TRDP - TTDB STATUS | TTDB - Operational Train Directory Status Telegram |
| 934  | 0.996623 | 10.0.0.1 | 239.194.0.0 | 33853 + 17224 Len=112 | TRDP - TTDB STATUS | TTDB - Operational Train Directory Status Telegram |
| 1083 | 1.000697 | 10.0.0.1 | 239.194.0.0 | 33853 + 17224 Len=112 | TRDP - TTDB STATUS | TTDB - Operational Train Directory Status Telegram |
| 1228 | 0.999255 | 10.0.0.1 | 239.194.0.0 | 33853 + 17224 Len=112 | TRDP - TTDB STATUS | TTDB - Operational Train Directory Status Telegram |
| 1375 | 1.000988 | 10.0.0.1 | 239.194.0.0 | 33853 + 17224 Len=112 | TRDP - TTDB STATUS | TTDB - Operational Train Directory Status Telegram |
| 1519 | 1.000456 | 10.0.0.1 | 239.194.0.0 | 33853 + 17224 Len=112 | TRDP - TTDB STATUS | TTDB - Operational Train Directory Status Telegram |
| 1667 | 0.998678 | 10.0.0.1 | 239.194.0.0 | 33853 + 17224 Len=112 | TRDP - TTDB STATUS | TTDB - Operational Train Directory Status Telegram |
| 1815 | 1.000793 | 10.0.0.1 | 239.194.0.0 | 33853 + 17224 Len=112 | TRDP - TTDB STATUS | TTDB - Operational Train Directory Status Telegram |
| 1992 | 1.000559 | 10.0.0.1 | 239.194.0.0 | 33853 + 17224 Len=112 | TRDP - TTDB STATUS | TTDB - Operational Train Directory Status Telegram |
| 2142 | 1.002552 | 10.0.0.1 | 239.194.0.0 | 33853 + 17224 Len=112 | TRDP - TTDB STATUS | TTDB - Operational Train Directory Status Telegram |
| 2291 | 0.996227 | 10.0.0.1 | 239.194.0.0 | 33853 + 17224 Len=112 | TRDP - TTDB STATUS | TTDB - Operational Train Directory Status Telegram |
| 2435 | 1.001654 | 10.0.0.1 | 239.194.0.0 | 33853 + 17224 Len=112 | TRDP - TTDB STATUS | TTDB - Operational Train Directory Status Telegram |
| 2584 | 1.006117 | 10.0.0.1 | 239.194.0.0 | 33853 + 17224 Len=112 | TRDP - TTDB STATUS | TTDB - Operational Train Directory Status Telegram |
| 2741 | 0.991411 | 10.0.0.1 | 239.194.0.0 | 33853 + 17224 Len=112 | TRDP - TTDB STATUS | TTDB - Operational Train Directory Status Telegram |
| 2888 | 1.000959 | 10.0.0.1 | 239.194.0.0 | 33853 + 17224 Len=112 | TRDP - TTDB STATUS | TTDB - Operational Train Directory Status Telegram |
| 3036 | 1.000481 | 10.0.0.1 | 239.194.0.0 | 33853 + 17224 Len=112 | TRDP - TTDB STATUS | TTDB - Operational Train Directory Status Telegram |

- Get ECSP information.  
The ECSP (10.0.0.1) periodically sends out the ECSP status to the ECSC (Ethernet Control Service Client, IP=10.0.0.112, configured the IP in the consist info XML file). Users can use the TRDP application to get ECSP status.

| No.  | Time     | Source   | Destination | Info                 | Protocol           | ComId                  | leadingReq | inhibit | Length |
|------|----------|----------|-------------|----------------------|--------------------|------------------------|------------|---------|--------|
| 23   | 0.000000 | 10.0.0.1 | 10.0.0.112  | 33853 → 17224 Len=80 | TRDP - ECSP STATUS | ecsp - Status Telegram |            |         |        |
| 170  | 1.000452 | 10.0.0.1 | 10.0.0.112  | 33853 → 17224 Len=80 | TRDP - ECSP STATUS | ecsp - Status Telegram |            |         |        |
| 318  | 0.991593 | 10.0.0.1 | 10.0.0.112  | 33853 → 17224 Len=80 | TRDP - ECSP STATUS | ecsp - Status Telegram |            |         |        |
| 492  | 1.001417 | 10.0.0.1 | 10.0.0.112  | 33853 → 17224 Len=80 | TRDP - ECSP STATUS | ecsp - Status Telegram |            |         |        |
| 639  | 1.000492 | 10.0.0.1 | 10.0.0.112  | 33853 → 17224 Len=80 | TRDP - ECSP STATUS | ecsp - Status Telegram |            |         |        |
| 787  | 1.002041 | 10.0.0.1 | 10.0.0.112  | 33853 → 17224 Len=80 | TRDP - ECSP STATUS | ecsp - Status Telegram |            |         |        |
| 935  | 0.996623 | 10.0.0.1 | 10.0.0.112  | 33853 → 17224 Len=80 | TRDP - ECSP STATUS | ecsp - Status Telegram |            |         |        |
| 1084 | 1.000697 | 10.0.0.1 | 10.0.0.112  | 33853 → 17224 Len=80 | TRDP - ECSP STATUS | ecsp - Status Telegram |            |         |        |
| 1229 | 0.999255 | 10.0.0.1 | 10.0.0.112  | 33853 → 17224 Len=80 | TRDP - ECSP STATUS | ecsp - Status Telegram |            |         |        |
| 1376 | 1.000908 | 10.0.0.1 | 10.0.0.112  | 33853 → 17224 Len=80 | TRDP - ECSP STATUS | ecsp - Status Telegram |            |         |        |
| 1520 | 1.000456 | 10.0.0.1 | 10.0.0.112  | 33853 → 17224 Len=80 | TRDP - ECSP STATUS | ecsp - Status Telegram |            |         |        |
| 1668 | 0.998578 | 10.0.0.1 | 10.0.0.112  | 33853 → 17224 Len=80 | TRDP - ECSP STATUS | ecsp - Status Telegram |            |         |        |
| 1816 | 1.000793 | 10.0.0.1 | 10.0.0.112  | 33853 → 17224 Len=80 | TRDP - ECSP STATUS | ecsp - Status Telegram |            |         |        |
| 1993 | 1.000559 | 10.0.0.1 | 10.0.0.112  | 33853 → 17224 Len=80 | TRDP - ECSP STATUS | ecsp - Status Telegram |            |         |        |
| 2143 | 1.002552 | 10.0.0.1 | 10.0.0.112  | 33853 → 17224 Len=80 | TRDP - ECSP STATUS | ecsp - Status Telegram |            |         |        |
| 2292 | 0.996227 | 10.0.0.1 | 10.0.0.112  | 33853 → 17224 Len=80 | TRDP - ECSP STATUS | ecsp - Status Telegram |            |         |        |
| 2436 | 1.001654 | 10.0.0.1 | 10.0.0.112  | 33853 → 17224 Len=80 | TRDP - ECSP STATUS | ecsp - Status Telegram |            |         |        |
| 2585 | 1.006117 | 10.0.0.1 | 10.0.0.112  | 33853 → 17224 Len=80 | TRDP - ECSP STATUS | ecsp - Status Telegram |            |         |        |
| 2742 | 0.991411 | 10.0.0.1 | 10.0.0.112  | 33853 → 17224 Len=80 | TRDP - ECSP STATUS | ecsp - Status Telegram |            |         |        |
| 2889 | 1.000959 | 10.0.0.1 | 10.0.0.112  | 33853 → 17224 Len=80 | TRDP - ECSP STATUS | ecsp - Status Telegram |            |         |        |
| 3037 | 1.000481 | 10.0.0.1 | 10.0.0.112  | 33853 → 17224 Len=80 | TRDP - ECSP STATUS | ecsp - Status Telegram |            |         |        |

- Use the TRDP application as ECSC to control the ECSP.  
For example, users can change the leading direction by sending the ECSP control packet with a different value in the **leadingDir** field.

| No. | Time     | Source     | Destination | Info                 | Protocol           | ComId                   | leadingReq | inhibit | Length |
|-----|----------|------------|-------------|----------------------|--------------------|-------------------------|------------|---------|--------|
| 1   | 0.000000 | 10.0.0.112 | 10.0.0.1    | 50030 → 17224 Len=80 | TRDP - ECSP CTRL   | ECSP - Control Telegram | False      | False   |        |
| 4   | 0.317069 | 10.0.0.1   | 10.0.0.112  | 33853 → 17224 Len=80 | TRDP - ECSP STATUS | ecsp - Status Telegram  |            |         |        |
| 5   | 0.716556 | 10.0.0.112 | 10.0.0.1    | 50030 → 17224 Len=80 | TRDP - ECSP CTRL   | ECSP - Control Telegram | False      | False   |        |
| 7   | 0.278391 | 10.0.0.1   | 10.0.0.112  | 33853 → 17224 Len=80 | TRDP - ECSP STATUS | ecsp - Status Telegram  |            |         |        |
| 8   | 0.768009 | 10.0.0.112 | 10.0.0.1    | 50030 → 17224 Len=80 | TRDP - ECSP CTRL   | ECSP - Control Telegram | False      | False   |        |
| 10  | 0.231013 | 10.0.0.1   | 10.0.0.112  | 33853 → 17224 Len=80 | TRDP - ECSP STATUS | ecsp - Status Telegram  |            |         |        |
| 11  | 0.812221 | 10.0.0.112 | 10.0.0.1    | 50030 → 17224 Len=80 | TRDP - ECSP CTRL   | ECSP - Control Telegram | False      | False   |        |
| 13  | 0.187535 | 10.0.0.1   | 10.0.0.112  | 33853 → 17224 Len=80 | TRDP - ECSP STATUS | ecsp - Status Telegram  |            |         |        |
| 14  | 0.846909 | 10.0.0.112 | 10.0.0.1    | 50030 → 17224 Len=80 | TRDP - ECSP CTRL   | ECSP - Control Telegram | False      | False   |        |

```

Header
  sequenceCounter: 0x00000010
  protocolVersion: 1.0
  msgType: Pd - PD Data (0x5064)
  ComId: ECSP - Control Telegram (120)
  etbTopCnt: 0x00000000
  opTrnTopCnt: 0x00000000
  dataSetLength: 40
  replyComId: Unspecified (0)
  replyIpAddress: 0.0.0.0
  headerFcs: 0xafc7d74b
ECSP CTRL
  version: 1.0
  deviceName: devECSC
  inhibit: False (0)
  leadingReq: False (0)
  leadingDir: Not relevant (0)
  sleepReq: False (0)
  safetyTrail
    userDataVersion: 0.0
    safeSequCount: 0
    safetyCode: 0
  
```

## Getting ECSP Data with the Web GUI

Get ETB status and Train Network Directory with ECSP using a the web GUI.

1. Using an account with **Admin** authority, log in to the network device.
2. Do any of the following:

Choose from:

- To view **ETB Status**, go to **Industrial Application**→**IEC 61375**→**Ethernet Train Backbone**→**ETB Status**.

- To view the **Train Directory**, go to **Industrial Application**→**IEC 61375**→**Operational Status**→**Train Directory**.

### Viewing ETB Status

**ETB Status** 1970/01/22 10:31:53

remoteInhibition: Undefined    Lengthen: False    Shorten: False

---

**Connectivity Table**

ConnTableValid: True    ConnTableCrc32: 970E5468

🔍 Search

| Index | Orientation | Mac Address       |
|-------|-------------|-------------------|
| 1     | Direct      | 00:90:E8:96:7F:D0 |
| 2     | Direct      | 00:90:E8:B2:56:12 |
| 3     | Direct      | 00:90:E8:12:34:65 |
| 4     | Direct      | 00:90:0E:12:43:56 |

Items per page: 5    1 - 4 of 4    |< < > >|

### Viewing Train Network Directory

**Train Network Directory**

EtbTopoCrcValid: True

EtbTopoCrc: 2DC57258    Memorized EtbTopoCrc: 2DC57258

🔍 Search

| Index | CellUID                              | CN ID | Subnet ID (Train Subnet) | ETB ID | CellOrientation |
|-------|--------------------------------------|-------|--------------------------|--------|-----------------|
| 1     | 00000000-0000-0000-0000-000000000001 | 1     | 10.128.64.0/18           | 1      | Direct          |
| 2     | 00000000-0000-0000-0000-000000000001 | 1     | 10.128.64.0/18           | 2      | Direct          |
| 3     | 00000000-0000-0000-0000-000000000002 | 1     | 10.128.128.0/18          | 3      | Direct          |
| 4     | 00000000-0000-0000-0000-000000000002 | 1     | 10.128.128.0/18          | 4      | Direct          |

Items per page: 5    1 - 4 of 4    |< < > >|

# Scenario: 2 Consists, with 1 ETBN/ECSP Each

In this example, we demonstrate an inter-consist network connection with a single, non-redundant ETBN in each consist.

The ECSC on Consist 1 wants to send a command to devDoor, located on Consist 2. TCN-DNS and R-NAT make this easy, without requiring unique configuration.

While coupling two consists, as long as the inauguration is not inhibited, the train network is automatically re-established following the IEC 61375 inauguration procedure. The ETBN Router on each consist functions as a TCN-DNS server that can resolve TCN-URI requests. It also serves as a router to route the traffic to other VLAN domains.

In this example, the ECSC on Consist 1 needs to communicate with the ED (devDoor) with a TCN-URI, such as devDoor.opVeh02.anyCst.ITrn on Consist 2. Packets will be relayed to ETBN Router 1, then ETBN Router 2, before finally reaching the destination train network IP (10.128.128.10).

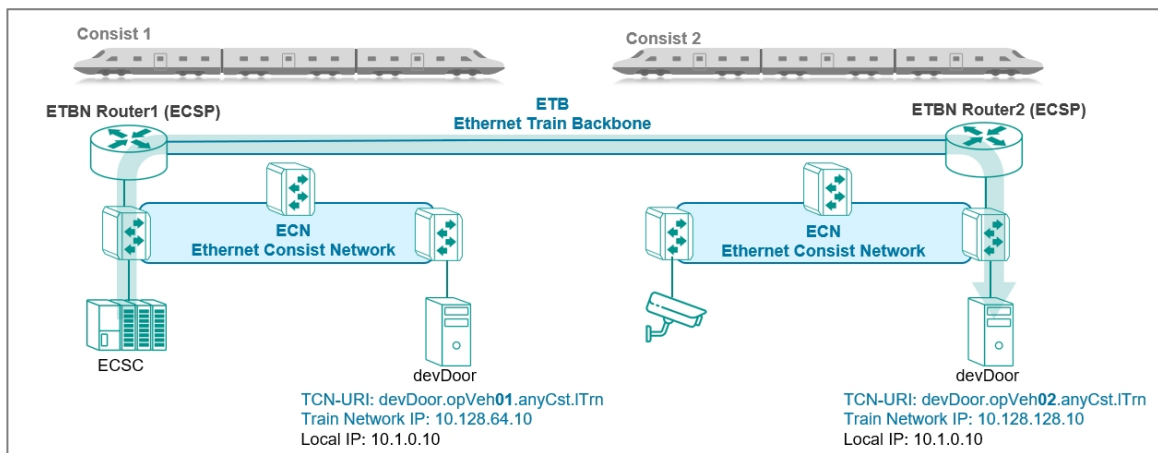

## Example: Configuring 2 Consists with 1 ETBN/ECSP Each

Redundant routers in each consist provide an extra layer of reliability.

- Make sure that hardware environment is ready to accommodate this topology and configuration.
- Make sure that you have correctly defined the XML configuration file required for Communication Profiles. While this tutorial provides a sample file, it only covers one consist. Refer to Structure and Syntax of Consist Info Configuration Files for more information about XML configuration files.

To configure hardware to match the example configuration with 2 Consists with 1 ETBN Router each, do the following:

1. Configure Consist 1:
  - a. Configure TTDP on the Consist 1 ETBN router.  
Refer to [Example: Configuring TTDP for ETBN Router on Consist 1](#) for detailed instructions.
  - b. Configure IEC 61375 Communication Profile on the Consist 1 ETBN router.  
Refer to Example: Configuring Communication Profiles for ETBNs/ECSPs for detailed instructions.
2. Configure Consist 2:
  - a. Configure TTBN on the Consist 2 ETBN router.  
Refer to Example: Configuring TTDP for ETBN Router on Consist 2 for detailed instructions.
  - b. Configure IEC 61375 Communication Profile on the Consist 2 ETBN router.  
Refer to [Example: Configuring Communication Profiles for ETBNs/ECSPs](#) for detailed instructions.

The TTDP configuration procedure for each ETBN router is similar. The following provides a quick reference of the differences in each configuration: Comparison of 2 Consists with 1 ETBN/ECSP Each

|                     | Consist 1                            | Consist 2                            |
|---------------------|--------------------------------------|--------------------------------------|
|                     | ETBN Router 1                        | ETBN Router 1                        |
| <b>Consist UUID</b> | 00000000-0000-0000-0000-000000000001 | 00000000-0000-0000-0000-000000000002 |

## Example: Configuring TTDP for ETBN Router on Consist 1

Here's how to perform the GUI configuration for a 1 ETBN/ECSP sample train network.

1. Using an account with Admin authority, log in to the network device.
2. Go to **Industrial Application**→**IEC 61375**→**Ethernet Train Backbone**→**TTDP Settings**.
3. Set **TTDP Enable** to **Enabled**.
4. Under **Local Consist**, configure all of the following:

| Option                    | Description  |
|---------------------------|--|
| <b>ETB Backbone ID</b>    | <b>0</b><br>This field identifies the type of traffic carried by the ETB, and should be the same within the same ETB.  |
| <b>Consist UUID</b>       | <b>00000000-0000-0000-0000-000000000001</b><br>The UUID is the same within the same consist. The example UUID is manually assigned, but they can also be randomly generated.         |
| <b>ETBN(s) in Consist</b> | <b>1</b><br>Dictated by our sample topology.   |
| <b>ECN(s) in Consist</b>  | <b>1</b><br>Multi-application consists might have additional ECNs to support additional applications - such as having both TCMS and Media - but our example is limited to 1 for now. |

5. Under **Local ETBN**, configure all of the following:

| Option                      | Description  |
|-----------------------------|--|
| <b>Local ETBN Static ID</b> | <b>1</b><br>Identifies the ETBN when there are multiple ETBNs in the same consist.   |
| <b>Direction 1</b>          | <b>Trunk 1</b><br>In TN-4908, port 1,2 will be set as trunk 1, and port 5,6 will be set as trunk 2.<br>Important: The direction of all ETBNs in the same consist should be the same. |
| <b>Direction 2</b>          | <b>Trunk 2</b>   |

| Option                  | Description  |
|-------------------------|--|
| <b>ETB Port Speed</b>   | <b>Auto</b>  |
| <b>ETB Port VLAN ID</b> | 1000<br>Defines the VLAN ID of the ETB interface. The TTDP function will generate the corresponding ETB and ECN interface. |

**Result:** Once the **Local Consist** and **Local ETBN** information is filled out, the **Add (+)** button will be available.

6. Click **Add (+)** to add a Consist Network.  
The **Add ECN** screen appears.

7. In the **Add ECN** screen, configure the following:

| Option                          | Description   |
|---------------------------------|---|
| <b>ECN to ETBN</b>              | <b>ETBN 1</b>   |
| <b>ECN Port VLAN ID</b>         | 1001 <ul style="list-style-type: none"> <li>For single ECN consists, the value should be shared by all ETBNs, and should be at least 1000. ETBNs on the same VLAN should have different IP addresses.</li> <li>For multi-application consists with multiple ECNs where each ETBN handles a different ECN, the default value is 1000 + <b>Local ETBN Static ID</b>.</li> </ul>   |
| <b>ECN interface IP address</b> | 10.0.0.1<br>Defines the IP of the ECN interface. Devices in the ECN network can access the ETBN using the ECN interface IP. If you are configuring multiple ETBNs on the same VLAN, they must have different IP addresses.<br><br>Use caution when setting this as the default gateway. Because this example uses redundant ETBNs, if the primary ETBN fails and the backup takes over, the gateway IP address changes. You can avoid disruptions to cross-consist communication by leveraging VRRP. Refer to <a href="#">Redundancy &gt; Layer 3 Redundancy &gt; VRRP</a> for more information about VRRP. |
| <b>ECN Ports</b>                | <b>port3, port4, port7, and port8</b><br>The field is to define which ports on the TN-4900 are the ECN ports. These selected ports will be assigned to the ECN interface.   |

- Click **Apply**.

**Results:** You have configured TTDP for the ETBN router on Consist 1.

**What to do next:** To finish configuring of this ETBN router, you must configure the Communication Profile by uploading an XML configuration file. Refer to [Example: Configuring Communication Profiles for ETBNs/ECSPs](#) for detailed instructions.

After configuring the ETBN router on Consist 1, you must configure the ETBN router on Consist 2.

This example uses 2 ETBN routers, 1 on each consist. All ETBN routers in all consists must be correctly configured before the example setup is complete.

## Example: Configuring TTDP for ETBN Router on Consist 2

Here's how to perform the GUI configuration for a 2 ETBN/ECSP sample train network.

- Using an account with Admin authority, log in to the network device.
- Go to **Industrial Application**→**IEC 61375**→**Ethernet Train Backbone**→**TTDP Settings**.
- Set **TTDP Enable** to **Enabled**.
- Under **Local Consist**, configure all of the following:

| Option                    | Description  |
|---------------------------|--|
| <b>ETB Backbone ID</b>    | <b>0</b><br>This field identifies the type of traffic carried by the ETB, and should be the same within the same ETB.  |
| <b>Consist UUID</b>       | <b>00000000-0000-0000-0000-000000000002</b><br>The UUID is the same within the same consist. The example UUID is manually assigned, but they can also be randomly generated.         |
| <b>ETBN(s) in Consist</b> | <b>1</b><br>Dictated by our sample topology.   |
| <b>ECN(s) in Consist</b>  | <b>1</b><br>Multi-application consists might have additional ECNs to support additional applications - such as having both TCMS and Media - but our example is limited to 1 for now. |

- Under **Local ETBN**, configure all of the following:



| Option                      | Description  |
|-----------------------------|--|
| <b>Local ETBN Static ID</b> | <b>1</b><br>Identifies the ETBN when there are multiple ETBNs in the same consist.   |
| <b>Direction 1</b>          | <b>Trunk 1</b><br>In TN-4908, port 1,2 will be set as trunk 1, and port 5,6 will be set as trunk 2.<br>Important: The direction of all ETBNs in the same consist should be the same. |
| <b>Direction 2</b>          | <b>Trunk 2</b>   |
| <b>ETB Port Speed</b>       | <b>Auto</b>  |
| <b>ETB Port VLAN ID</b>     | <b>1000</b><br>Defines the VLAN ID of the ETB interface. The TTDP function will generate the corresponding ETB and ECN interface.  |

**Result:** Once the **Local Consist** and **Local ETBN** information is filled out, the **Add** (  ) button will be available.

6. Click **Add** (  ) to add a Consist Network.  
The **Add ECN** screen appears.

7. In the **Add ECN** screen, configure the following:

| Option                  | Description  |
|-------------------------|--|
| <b>ECN to ETBN</b>      | <b>ETBN 1</b>  |
| <b>ECN Port VLAN ID</b> | <b>1001</b> <ul style="list-style-type: none"> <li>For single ECN consists, the value should be shared by all ETBNs, and should be at least 1000. ETBNs on the same VLAN should have different IP addresses.</li> <li>For multi-application consists with multiple ECNs where each ETBN handles a different ECN, the default value is 1000 + <b>Local ETBN Static ID</b>.</li> </ul> |

| Option                          | Description   |
|---------------------------------|---|
| <b>ECN interface IP address</b> | <p><b>10.0.0.1</b></p> <p>Defines the IP of the ECN interface. Devices in the ECN network can access the ETBN using the ECN interface IP. If you are configuring multiple ETBNs on the same VLAN, they must have different IP addresses.</p> <p>Use caution when setting this as the default gateway. Because this example uses redundant ETBNs, if the primary ETBN fails and the backup takes over, the gateway IP address changes. You can avoid disruptions to cross-consist communication by leveraging VRRP. Refer to <a href="#">Redundancy &gt; Layer 3 Redundancy &gt; VRRP</a> for more information about VRRP.</p> |
| <b>ECN Ports</b>                | <p><b>port3, port4, port7, and port8</b></p> <p>The field is to define which ports on the TN-4900 are the ECN ports. These selected ports will be assigned to the ECN interface.</p>  |

8. Click **Apply**.

**Results:** You have configured TTDP for the ETBN router on Consist 2.

**What to do next:** To finish configuring of this ETBN router, you must configure the Communication Profile by uploading an XML configuration file. Refer to [Example: Configuring Communication Profiles for ETBNs/ECSPs](#) for detailed instructions.

This example uses 2 ETBN routers, 1 on each consist. All ETBN routers in all consists must be correctly configured before the example setup is complete.

# Example: Configuring Communication Profiles for ETBNs/ECSPs

ECSPs rely on static XML files that define devices within a consist.

The ETB Control Service Provider (ECSP) runs on each ETBN, and controls the ETB. They ensure efficient communication and event handling. ETBs require static consist information, uploaded in the form of an XML file on Moxa ETBN routers. These files are compiled by the user.

**Before you begin:** Make sure you have compiled an XML file with device information for each consist. Refer to Structure and Syntax of Consist Info Configuration Files for more information about XML configuration files.

Refer to Appendix: Sample Communication Profile Configuration File for a sample file for a single consist.

To upload a configuration file to the ETBN router:

1. Go to **Industrial Application**→**IEC 61375**→**Communication profile**→**TTDP Settings**.
2. Under **Local Consist Info**, click **Import Local Consist Info**.

**Result:** Your browser's file selection window will appear.

3. Navigate to the configuration file in your file system, and select it.

The exact button chosen will vary by operating system and browser. As of April 2024, in Microsoft Edge on Windows, the relevant button is **Open**.

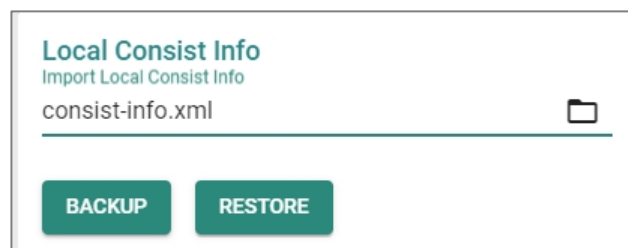

**Result:** The chosen filename appears under **Import Local Consist Info**.

4. Click **Restore** to import the consist info.

**Result: Successfully Updated** appears briefly on the screen.

**What to do next:** You can verify that the correct consist information has been uploaded by going to **Operation Status**→**Consist Info**→**Function list** and verifying that the table correctly displays device and consist information.

## Chapter 7

---

# Security Hardening Guide

# Security Hardening Guide Overview

This chapter provides an overview of security strategy, standards, and recommended best practices to improve the security landscape.

The threat landscape is constantly evolving, and no security guide can ever provide 100% protection. This chapter is constantly being expanded, and is not exhaustive.

# Security Best Practices

## Introduction to Defense in Depth

The Defense-in-Depth strategy is used to protect systems from various types of attacks by using multiple independent defense mechanisms.

This involves incorporating multiple layers of security to protect the product against potential attacks and vulnerabilities at various stages of its design, development, and use.

It is crucial to understand that no single protection can guarantee complete security. That's why the Defense-in-Depth approach makes it difficult for attackers to leverage one weakness to attack the product or network as a whole. This approach requires attackers to overcome multiple obstacles undetected, increasing the difficulty level. By leveraging multiple security features and layers of protection in a product, vulnerabilities in any one layer can be mitigated.

## Product Security

This section provides essential information on the installation of your product.

### Physical Installation Guidelines

Physical protection of devices is vital to network security.

With physical access to devices, prospective attackers can physically bypass security mechanisms, alter network conditions, or plant additional malicious devices in networks. Follow these tips to help reduce the risk of tampering with networking devices by unauthorized personnel.

- Install switch/router in an access-controlled area. To further protect your device from potential physical attacks, it is important to conduct a risk analysis and implement appropriate physical security measures. Consider physical security like installation within a locked cabinet, surveillance, security guards, and access control systems, among other measures. The specific measures you choose should be based on your environment and the level of risk you face.

- Install a Layer 2 switch within the security perimeter. This perimeter can be established by setting up a firewall at the border, as the switch is not designed to be directly connected to the Internet. Note that the switch should not be classified as zone or boundary equipment. Avoid connecting the device directly to the Internet, as this can leave your network vulnerable to security breaches.
- Follow the Quick Installation Guide included in the package of your device. It contains step-by-step instructions that are easy to follow and will help you set up the device quickly and efficiently.
- Examine and monitor anti-tamper labels applied to the device enclosures. These labels provide a quick and easy way for administrators to determine if the device has been tampered with.
- Deactivate any ports that are not currently in use. Fewer active ports represent fewer avenues of attack. Refer to [Network Interfaces](#) for more information.

## Account Management Guidelines

Manage user accounts, set passwords, and restrict access to authorized personnel only.

- Assign the appropriate account privileges.

Limit the number of users with admin privileges to only those who need to perform device configuration or modifications. For other users, read-only access is sufficient. Moxa devices supports both local account authentication and remote centralized mechanisms, including RADIUS and TACACS+. This allows for flexible and secure access control options.

- Implement good password practices. Good password practices include:
  - Enabling and configuring a Password Policy to ensure your password meets specified requirements.
  - Setting the minimum password length to at least eight characters.
  - Require passwords to have at least one uppercase and lowercase letter, a digit, and a special character.
  - Setting password expiration.
  - Updating passwords regularly.
  - Never sharing passwords.



**Note**

Based on trends in cybersecurity regulations, we recommend users increase the complexity of their passwords to the highest level to further strengthen password security.

Refer to [Password Policy](#) for more information about password policies.

## Protecting Vulnerable Network Ports

Understand security risks and mitigate them by configuring network ports correctly.

- Changing port numbers for active services, including TCP port numbers for HTTP, HTTPS, Telnet, and SSH.
- Disable any ports that are not in use, as they could pose an unacceptable security risk.
- Use encrypted communication protocols wherever available. Use HTTPS instead of HTTP, SSH instead of Telnet, SFTP instead of TFTP, and SNMPv3 instead of SNMPv1/v2c. Refer to [Network Interfaces](#) for more information.
- Configure automatic session locking or idle timeouts so that idle sessions cannot be hijacked.
- Generate new SSL certificates and SSH keys for devices prior to using HTTPS or SSH applications. Refer to [SSH & SSL](#) for more information.

## Maintaining Communication Integrity

Ensure that information sent is accurate, complete, and secure.

Maintaining communication integrity reduces risks risk of data corruption or interception, and associated security breaches, data loss, and other negative effects on networks and their users.

- Use encryption.

Encryption uses mathematical algorithms to convert data into a secret code, making it extremely difficult for people without the correct codes to read or change the data. By using encryption, you can ensure that the data being transmitted is secure and cannot be intercepted by unauthorized users.

- Use digital signatures.

Digital signatures verify the authenticity and integrity of digital documents or messages. Using a digital signature, you can ensure that the message or document came from the expected sender and has not been altered.

- Implement access control.

Access control restricts access to only authorized users to the network and its resources. By implementing access control measures, such as firewalls or access control lists, you can prevent unauthorized access and reduce the risk of data breaches.

## **Communication Integrity Features**

Moxa devices provide support for VPNs and secure versions of protocols to help maintain communication integrity.

### **VPN (Virtual Private Network)**

VPN is a secure network connection allowing users to access a private network. VPNs use encryption and authentication to protect the data in transit, which makes it difficult for anyone to intercept or tamper with the data. VPNs also provide access control features to ensure only authorized users can access the network. VPNs are commonly used to securely connect remote workers to a company network securely or to allow secure access to restricted resources over the internet.

Refer to [VPN](#) for more information.

### **HTTPS (Hypertext Transfer Protocol Secure)**

HTTPS is a secure version of the regular HTTP protocol for transmitting data over the internet. HTTPS uses TLS (Transport Layer Security) encryption and digital certificates to protect the data in transit from interception, tampering, or eavesdropping.

Refer to [Management Interface](#) for more information.

## SSH (Secure Shell)

SSH is a secure protocol for remote terminal login and secure file transfers. SSH uses encryption to protect the data in transit, making it difficult for anyone to intercept or tamper with it. SSH also provides authentication and access control features to ensure only authorized users can access the network.

Refer to [Management Interface](#) for more information.

## SFTP (Secure File Transfer Protocol)

SFTP is a secure version of FTP (File Transfer Protocol) that uses encryption to protect the data in transit. SFTP also provides authentication and access control features to ensure only authorized users can access the network.

Refer to [Management Interface](#) for more information.

## SNMP v3 (Simple Network Management Protocol version 3)

SNMP v3 is a secure version of the SNMP protocol used for network management and monitoring. SNMP v3 uses encryption and authentication to protect the data in transit, making it difficult for anyone to intercept or tamper with it. SNMP v3 also provides access control features to ensure only authorized users can access the network.

### Note

SNMP managers should be used in accordance with their own security hardening guides and recommended security procedures.

Refer to [SNMP](#) for more information.

## Device Access Control Best Practices

Device access control is an essential aspect of network security that helps protect against unauthorized access to network resources.

Unauthorized access can occur through various means, including physical access to network devices, hacking, or social engineering. Without proper access control measures

in place, networks are vulnerable to security breaches, data theft, and other malicious activities.

Device access control is particularly important for organizations that handle sensitive data, such as financial institutions, healthcare providers, and government agencies. By implementing device access control, these organizations can limit access to sensitive information and prevent security breaches. Below are some ways to ensure device access control:

- Adopt the Principle of Least Privilege. This principle involves granting users, applications, or systems the minimum level of access or permissions they need to perform their specific tasks and nothing more. Requests for additional access, such as HTTPS, SSH, or Moxa services for administration, should be carefully evaluated before being approved
- Use strong passwords. Passwords should be complex and unique for each device. Passwords should also be changed regularly to maintain security. Refer to [Password Policy](#) for further information.
- Implement allowlists. Allowlists are authorized devices or users allowed to access a particular network resource. Allowlists can be managed at the device, network, or application levels. Network administrators can use allowlists to ensure that only authorized devices or users can access sensitive resources. The key feature of an allowlist is that anything not on the allowlist is automatically blocked, ensuring only authorized devices, uses, or services can operate freely in a network environment. Refer to [Trusted Access](#) for further information.
- Implement an L3 firewall. An L3 firewall, also known as a Layer 3 firewall, is a network security device operating at the OSI model's network layer. L3 firewalls can monitor and filter traffic based on IP addresses, ports, protocols, and other network-level attributes. Using L3 firewalls, network administrators can prevent unauthorized access to the network and block potential security threats.

 **Note**

You can block intranet hosts from all external access with isolation, such as with a DMZ, and only allow connections from specifically authorized IP addresses.

**Note**

To enhance device security and ensure compliance with IEC 61162-460, consider the following practices:

1. Restrict Access:
  - Only allow connections from specific, verified, and secure hosts within a controlled network.
  - Maintain an authorized list of these approved source IPs, ensuring it is documented and regularly reviewed.
2. Block Uncontrolled Networks:
  - Do not permit direct access from hosts in uncontrolled or unverified networks.
3. Example Configuration:
  - Configure trusted access to accept traffic exclusively from source IPs within the 460-network.
  - Any IP address not on this allowlist, including those from non-control networks, will be blocked.

By adhering to these guidelines, you help maintain network security and comply with IEC 61162-460 requirements.

Refer to [Firewall](#) for further information.

## Configuring Allowlists in Compliance with IEC 61162-460

To enhance device security and ensure compliance with IEC 61162-460, implement the following practices:

- Restrict Access
  - Only allow connections from specific, verified, and secure hosts within a controlled network.
  - Maintain an authorized list of these approved source IPs, ensuring it is documented and regularly reviewed.
- Block Uncontrolled Networks
  - Do not permit direct access from hosts in uncontrolled or unverified networks.

By adhering to these guidelines, you help maintain network security and comply with IEC 61162-460 requirements.

## Example Configuration

- Configure trusted access to accept traffic exclusively from source IPs within the 460-network.
- Any IP address not on this allowlist, including those from non-control networks, will be blocked.

## About Device Integrity and Authenticity

Integrity and authenticity are vital elements of trust within a network.

Device integrity refers to the state of a device being complete, unaltered, and free from any unauthorized changes or modifications.

Authenticity refers to the assurance that the device is genuine and comes from a trusted source.

Both integrity and authenticity are critical aspects of device security. Methods to sustain these aspects include:

- Configuration Backup & Encryption
- Secure Boot

## Configuration Backup and Encryption

Configuration backup and encryption protects a device's sensitive data and configuration by creating an encrypted copy storing it securely. In the event of unauthorized device changes, correct configuration information can be quickly and securely restored.

The process involves creating a backup of the device's configuration and then encrypting it using a strong encryption algorithm. The encrypted backup is then stored securely to prevent unauthorized access. This process is particularly important for devices that store sensitive information, such as network equipment, servers, and other critical infrastructure. Encrypting the configuration backup ensures that the data remains protected even if the backup location is compromised.

## Secure Boot

Secure Boot is a security mechanism designed to ensure that devices boot using only software that is verified as trusted. The primary function of Secure Boot is to prevent

unauthorized software from running during the boot process. It achieves this by verifying the integrity and authenticity of the bootloader and firmware.

A bootloader refers to the initial software that runs when a device is powered on. Its primary role is to load the device's operating system. Firmware is software embedded within the device that manages and controls the device's hardware functions.

Moxa hardware makes use of cryptographic modules embedded in devices to support verification processes. The device's ROM (read-only memory) contains approved bootloaders and associated digital certificates, which are used to verify the integrity of the firmware.

When the device boots, the first thing to run is the bootloader. Secure boot checks the digital signature against the certificate stored in ROM. If the signatures match, the boot process continues. If they do not match, or there is evidence of tampering, the boot process halts to prevent potential security breaches.

## **Securing USB Interfaces on Network Devices**

- Disable USB ports when not in use.

USB ports should be disabled by default to prevent unauthorized or accidental use.

- Limit rights to enable or configure USB ports to a minimum number of authorized users.

Use role-based access control (RBAC) or require multi-factor authentication (MFA) to enable USB ports.

- Standardize procedures and rigorously observe them.

Your procedures should cover:

- When and why USB interfaces can be used
- The type and number of USB devices permitted
- How data on those devices must be secured. Ensure that all employees and users understand and observe these procedures

# Device Resource Management and Monitoring

Moxa devices provide a number of features to help customers manage device resources efficiently and monitor security.

## Device Resource Monitoring

Network device resource management is essential for network reliability and security. By monitoring use of network resources, administrators can verify that network guidelines are being followed and devices are operating efficiently and effectively.

Proactive monitoring and management of device resources such as CPU utilization, memory utilization, and network traffic allows administrators to identify potential security breaches early, and help avoid network downtime and disruption. For example, abnormal spikes in network traffic or CPU utilization could be indicative of a malware infection or a denial-of-service attack.

Examples of activities to monitor include:

- Connected ports
- CPU usage
- Memory usage

Refer to [Device Summary](#) for more information.

## Event Logs

In addition to real-time monitoring and management, Moxa devices provide advanced logging options to help identify security events. Chosen event types can also generate notifications to notify administrators of unusual events where attention is needed, or to feed into larger security monitoring systems.

Moxa devices offer three kinds of logs:

- System Logs, showing details of all system-related event logs
- Firewall logs, showing details of all patterns from layers 3-7, including
  - Trusted Access
  - Malformed Packets



- DoS Policy
  - Layer 3 – 7 Policy
  - Protocol Filter Policy
  - Anomaly Detection & Protection (ADP)
  - Intrusion Detection/Prevention System (IDS/IPS)
  - Session Control
- VPN logs, showing all VPN-related events

Refer to [Event Log](#) for more information about Event Logs.

Refer to [Event Notifications](#) for more information about Event Notifications.

Refer to [SNMP](#) for more information about SNMP configuration.

## Denial of Service (DoS) Protection

In a denial-of-service (DoS) attack, the attacker attempts to overwhelm a target system with a flood of traffic or requests. The deluge of traffic causes the target system to become paralyzed, and also causes disruptions in networks and online services.

Moxa devices can prevent several types of DoS attacks by rejecting requests which ask for a particular network scan, or rejecting too many such requests in a specified period.

Refer to DoS Policy setting for more information.

## Session Control

Session control refers to managing communication sessions between network objects, such as IP addresses or ports. The management process involves establishing, maintaining, and terminating sessions to ensure secure and reliable communication between various objects. Session control allows administrators to allocate device resources more efficiently by limiting the number of active sessions, and improving network security by dropping unused sessions.

Refer to [Session Control](#) for more information.

# Recommended Settings for Services and Features

When prioritizing device security, the first point of assessment is often the network interfaces and services.

By deactivating unneeded interfaces and services, one can reduce potential vulnerabilities and associated security threats. Additionally, activating the appropriate security features enhances early anomaly detection and bolsters the device's defense against cyber attacks.

## Common Protocols and Ports

| Service Name         | Default Port                                 | Default Setting | Security Suggestions  |
|----------------------|--|-----------------|---|
| <b>HTTP</b>          | TCP 80                                       | Enabled         | Disable if possible to avoid leaks from unencrypted traffic.  |
| <b>HTTPS</b>         | TCP 443                                      | Enabled         |   |
| <b>Telnet</b>        | TCP 23                                       | Enabled         | Disable if possible to avoid leaks from unencrypted traffic.  |
| <b>SSH</b>           | TCP 22                                       | Enabled         |   |
| <b>NTP/SNTP</b>      | UDP 123                                      | Disabled        | Use SNTP to synchronize system time if possible.<br>Enable NTP authentication if possible.  |
| <b>SNMP</b>          | UDP 161<br>UDP 162<br>TCP 10161<br>TCP 10162 | Disabled        | For V1 & V2c, change default community string names, i.e. public & private, to other unique names.<br>For V3, enable SNMP admin account authentication.   |
| <b>Syslog</b>        | UDP 514                                      | Disabled        | Enabling Syslog is recommended to avoid missing critical logs due to limited local storage. This sends logs to an external syslog server, where they can be securely stored and retained. The syslog server is responsible for keeping these logs for a minimum period required by local regulations, ensuring critical incidents are properly documented and accessible when needed. |
| <b>RADIUS</b>        | UDP 1812                                     | Disabled        | Enabling RADIUS authentication can help administrators manage password changes more efficiently.  |
| <b>Moxa Services</b> | TCP 443<br>UDP 40404                         | Enabled         | These 2 ports are only used by the Moxa management software. Disable it if you don't use Moxa management software.  |

## Security-Related Functions

| Function                           | Default Setting | Security Suggestions  |
|------------------------------------|-----------------|---|
| <b>Firewall</b>                    | Deny All        | Without precise firewall rules configuration, "Allow All" has a higher chance to allow unwanted packets going into the protected network, so we highly suggest using "Deny All" instead of "Allow All".<br><br>Refer to Scenario: Airport Integrated Solutions to learn more about Allow Lists. |
| <b>Password Policy</b>             | Disable         | Enable password policy to comply enterprise security policies.  |
| <b>Login policy</b>                | Disable         | Enable a login policy to heighten resistance against brute force attacks and terminating any inactive login sessions.   |
| <b>Malformed Packets Filtering</b> | Disable         | The "Malformed Packets Filtering" feature logs events at a user-defined severity level whenever the system discards malformed packets. Depending on the protocols active in your network, you can choose to enable this feature or leave it disabled.   |
| <b>DoS Policy</b>                  | None            | Select a DoS policy according to your network traffic to increase network robustness.   |
| <b>Session control</b>             | None            | Configure session control policies appropriate for your traffic to improve network reliability.   |
| <b>802.1X over ports</b>           | Disable         | Enable 802.1X port authentication to block unauthorized LAN access.   |
| <b>Trusted Access</b>              | Enabled         | By default, the device permits all connections from the LAN attempting to access it. For enhanced security, block all LAN connections attempting to access the device. Then, use a trusted IP list to specify which trusted IPs are allowed access to the device.                               |

## Common Threats and Countermeasures

These are examples of common known threats, and suggestions for mitigation.

| Incident Category                             | Detailed Description   | Mitigation Suggestions                                  |
|---|--|---|
| <b>Tampering &amp; Information Disclosure</b> | An attacker can read or modify data transmitted over HTTP data flow. | Disable HTTP, and replace HTTP transmission with HTTPS. |

| Incident Category                             | Detailed Description  | Mitigation Suggestions   |
|---|---|--|
| <b>Tampering &amp; Information Disclosure</b> | An attacker can read or modify data transmitted over Telnet data flow.    | Disable Telnet, and replace HTTP transmission by SSH.                              |
| <b>Information Disclosure</b>                 | Data flowing across TFTP may be sniffed by an attacker.                   | Use SFTP instead of FTP.   |
| <b>Denial of Service</b>                      | SNMP Server crashes, halts, stops or runs slowly by excessive quires.     | Enable rate limit to stop excessive SNMP requests.                                 |
| <b>Denial of Service</b>                      | RADIUS Server crashes, halts, stops or runs slowly by excessive quires.   | Enable rate limit to stop excessive RADIUS requests.                               |
| <b>Repudiation</b>                            | Devices fail to synchronize a system time with a trusted NTP/SNTP server. | Enable NTP authentication to verify a connection with the trusted NTP/SNTP server. |

#### Note

Create an incident response plan and follow it carefully. Ensure your procedures allow for user reporting and admin response to those reports. Many threats manifest themselves as irregular device behavior – such as device inability to provide basic services like routing or firewall functions, which in turn lead to interruptions or unauthorized access. Create a plan that allows admins to prepare, reboot, and monitor devices with abnormal behavior.

## Recommended Operational Roles and Duties

Adhering to the principle of least privilege reduces risks by ensuring users operate at the minimum privilege required to complete their tasks.

Instead of individual allocation, privilege levels should be tied to specific job functions. For optimized device security, we recommend three distinct privilege levels, each tailored for different management needs:

### Administrator

Designated for system management, this privilege level permits:

- Creation and deletion of configuration objects, files, and user accounts.
- Monitoring system status and resources.
- Modifying parameter values.

- Reviewing stored data within the device.

#### Administrator Responsibilities:

- Reset and periodically change the default administrator password.
- Ensure password complexity aligns with enterprise security policies.
- Manage and authorize individuals with appropriate access privileges.
- Disable non-essential interfaces or network services.
- Enable secure communication protocols to guard against data breaches.
- Regularly update firmware to address potential vulnerabilities.

## Supervisor

Tailored for network experts or operators, this privilege grants:

- Monitoring of system status and resources.
- Adjusting values in configuration objects or files.
- Access to review data stored in the device.

#### Supervisor Responsibilities:

- Continuously monitor system status and resources to maintain device functionality.
- Routinely verify the integrity of device configuration objects and files.
- Manage trusted devices through IP and MAC allowlisting.
- Oversee and respond to system alerts to preempt device failures and security threats.

## Auditor

Reserved for audit-focused personnel, this level allows:

- Monitoring of system status and resources.
- Reviewing data stored within the device.

#### Auditor Responsibilities:

- Regularly inspect logs to identify and assess incidents and their associated risks.

Moxa devices provide three user privilege categories: admin, supervisor, and user. We advise aligning the admin role for administrator users, the supervisor role for supervisor users, and the user role for auditor users.

Refer to:

- [User Accounts](#)

## Recommended Patching and Backup Practices

Moxa's guidance on ensuring device security through regular firmware upgrades and configuration backups.

### Firmware Upgrade

Moxa continuously releases firmware throughout the product lifecycle to improve features and rectify identified issues. Upon discovering a vulnerability, our approach aligns with the Moxa Product Security Incident Response Team (PSIRT) guidelines, ensuring swift and appropriate action.

Maintaining current firmware on your network devices is vital to maintain security. Using outdated firmware can expose the device to potential threats. We strongly advise periodic firmware updates. We consistently release the latest firmware and software on our official website, along with respective release notes. Check for these updates regularly.

#### **Note**

Firmware updates may cause downtime. Assess the impacts of downtime and prepare appropriately before initiating updates.

**Note**

Device performance may be degraded during the update process. Normal function should be restored once the update is complete and the device restarts.

## Configuration Backup

For network operators and system administrators, it is essential to regularly back up device configurations. This precaution allows for quick recovery in unforeseen scenarios, such as cyber attacks.

**Note**

Prioritize use of secure transfer protocols – such as SFTP – for file transfers to protect the configuration maintenance process.

Refer to:

- [Firmware Upgrade](#)
- [Configuration Backup and Restore](#)

## Recommendations for Vulnerability Management

As the adoption of the Industrial IoT (IIoT) continues to grow rapidly, security becomes an increasingly high priority.

The Moxa Product Security Incidence Response Team (PSIRT) takes a proactive approach to protect our products from security vulnerabilities and help our customers better manage security risks.

To report vulnerabilities for Moxa products, please submit your findings on the following web page: <https://www.moxa.com/en/support/product-support/security-advisory/report-a-vulnerability>.

For the most up-to-date Moxa security information, please visit our security advisory page: <https://www.moxa.com/en/support/product-support/security-advisory>

# Recommendations for Decommissioning

## Recommendations for Decommissioning

To avoid any sensitive information such as account passwords or network configurations from disclosure, always delete all imported certificates and reset devices to factory default before you decommission your devices.

### **Note**

Things to keep in mind when decommissioning or re-purposing devices:

- Device data can be cleared using the Factory Reset options. When resetting devices, make sure to confirm the operation and allow it sufficient time to complete.
- Delete all logs, and verify deletion.
- After all reset processes are complete, verify that all sensitive data has been cleared.



# Using Security Features

Ensuring the security features of your network device operate effectively is vital for maintaining a secure and reliable system. During field validation, include these features—such as firewalls, encryption, and intrusion prevention—in your testing plan to confirm they function properly in real-world conditions.

This chapter outlines the available security features, how to configure them, and best practices to ensure consistent protection for your network.

## Introduction to IPS

IPS (Intrusion Prevention System) is a network security technology used to detect and prevent potential threats in a network.

IPS analyzes the network traffic and identifies potential attacks, including viruses, worms, malware, and unauthorized access. Once an IPS detects a threat, it takes immediate action to block the attack and protect the security of the network and system. IPS uses signature-based and behavior analysis to identify threats and employs various techniques to protect systems, such as blocking IP addresses and protocols. It is an important component of network security architecture designed to enhance the security of networks and systems, prevent unauthorized access, and protect against data breaches.

## What is the difference between IDS and IPS?

IDS (Intrusion Detection System) and IPS are network security systems that help protect against security threats and vulnerabilities.

An IDS monitors network traffic and identifies potential security threats and attacks. When it detects a security threat, it saves logs and generates an alert, which is sent to the security team for further analysis and action. An IDS is a passive security system that only monitors network traffic and does not take any action to prevent or stop an attack.

On the other hand, an IPS monitors network traffic like an IDS, but also takes active measures to prevent security threats and attacks. Additionally, an IPS can block, quarantine, or even terminate network traffic or connections deemed suspicious or

malicious. IPS systems often use a set of predefined rules or policies to identify and respond to security threats in real-time.

The main difference between IDS and IPS is that IDS only detects and notifies of potential security threats, while IPS takes action to prevent and stop the security threat. IDS is generally considered a more passive security system, whereas IPS is more proactive and can take immediate action to mitigate security risks.

## IPS Applications

IPS is typically used to actively prevent and block unauthorized access or malicious activities on your network.

IPS is typically used when you want to actively prevent and block unauthorized access or malicious activities on your network. It's a proactive security solution that acts in real-time to prevent potential security threats from entering or leaving your network.

Here are some common applications of IPS:

1. **Protecting critical assets:** IPS can protect mission-critical assets or systems, such as PLCs, factory automation, ICS (Industrial Control System), from external and internal security threats.
2. **Resisting zero-day attacks:** IPS can help you detect and block unknown or zero-day attacks that have not yet been identified by traditional anti-virus or intrusion detection systems.
3. **Real-time threat detection:** IPS systems can provide real-time threat detection and prevention, reducing the risk of data breaches and other security incidents.
4. **Virtual patching:** Even devices with outdated OS can receive up-to-date protection without regular security updates and patches.

In summary, IPS should be used when you want to actively prevent and block security threats in real-time and protect critical assets or comply with specific regulations or standards.

## IPS Limitations

The most notable limitation of IPS is that it relies on updated patterns—updated definitions and countermeasures of known threats—to correctly detect and act on

threats. To address this issue, Moxa provides regular updates in the form of a security package. The packages must be installed by users periodically to maintain the latest protection capabilities. The update procedure and frequency should be standardized by organizational policy.

**Note**

Some products may not support syslog servers. For such devices, you can design a process, script, or system to periodically retrieve the IPS/IDS logs. Alternatively, you can enable port mirroring to direct traffic to a dedicated IPS device.

As of November 2024, syslog support is planned but not yet implemented for the following products:

- EDR-8010 Series
- EDR-G9010 Series

**Note**

IPS is not a substitute for antivirus software or security solutions. IPS scans network packets, but does not scan devices and is not antivirus software. If an attacker finds a way to run malicious code on the device itself, IPS may not detect the infection, but may still detect the packets sent as a result of such compromise. To increase chances of detection, you can:

- Enable IPS/IDS, configure all notification features, and monitor them diligently. If characteristics of malware/malicious code are detected in outgoing packets, administrators will be notified and can respond appropriately.
- Ensure USB ports are disabled by default and closely monitor them. Attackers may attempt to load malicious code over USB ports. Establishing careful control procedures can minimize this threat. Consider restricting USB devices only to Moxa ABC-02 and regularly scanning the ABC-02 with antivirus software.

## Example: Updating the Network Security Package via the Web GUI

Download the latest Network Security Package from the Moxa and install via the Web GUI.

**Before you begin:** Make sure you have purchased an activated an IPS license.

This task uses the Moxa EDR-G9010 series as an example product. Replace this product with your product for each step.

1. From the Moxa support website, navigate to **Resources**→**Software Packages**→**Network Security Package for EDR-G9010 Series**

The Moxa support website is located at <https://www.moxa.com/en/support>.

2. Download the latest version of the Network Security Package to your computer.
3. Open the router's web interface and navigate to **System→System Management→Software Package Management→Network Security Package**.
4. Click **Source**, and then choose **Local**.
5. Click **Select Files**, and then choose a file from your local file system.
6. Click **Upgrade** to start the upgrade process.

The upgrade process will begin, and the result appears at the bottom of the interface.

#### **What to do next:**

Confirm that the Network Security Package has been updated by checking the version information from the Package Information Screen. On the web interface, go to **Firewall→Advanced Protection→Information→Package Information**, and check the version listed.

## **Example: Updating the Network Security Package via MXsecurity**

Download the latest Network Security Package from the Moxa website and install with the MXsecurity web console.

**Before you begin:** Make sure you have purchased an activated an IPS license.

This task uses the Moxa EDR-G9010 series as an example product. Replace this product with your product for each step.

1. From the Moxa support website, navigate to **Resources→Software Packages→Network Security Package for EDR-G9010 Series**

The Moxa support website is located at <https://www.moxa.com/en/support>.

2. Download the latest version of the Network Security Package to your computer.
3. From the MXsecurity web console, go to **Device Deployment→Software Packages→Network Security Packages**.
4. Select the secure routers to update, and then click **Upgrade**.

**Results:** The upgrade process will begin on the selected routers, with the result displayed within seconds.

**What to do next:**

Confirm that the Network Security Package has been updated by checking the version information from the Package Information Screen. On the MXsecurity web console, go to **Device Deployment**→**Software Packages**, and check the version listed.

## Example: Configuring IPS Rules via MXsecurity

Enable IPS rules and observe the generated event from the MXsecurity, the centralized cybersecurity visualization platform.

**Before you begin:** Make sure you have:

- a configured MXsecurity server
  - an active IPS license that supports MXsecurity
  - at least one Network Security Package uploaded. See Example: Updating the Network Security Package via MXsecurity for upload steps.
1. From the MXsecurity web console, go to **Management**→**Policy Profile**.
  2. Click *[Add]*, and then configure:
    - **Profile Name**
    - **Description** (optional)
  3. Select **IPS**, and then choose one of the **Package Versions** from the list.
  4. Enable one or more IPS rules, then click **Apply**.

You can choose **Select All** to enable all protection.

**Result:** Your new policy profile is visible in the **Policy Profile** table.

5. To apply the profile, go to **Deployment**→**Policy Profile**.
6. Select the IPS profile, and then click **Apply**.

**Results:**

If an IPS event is triggered, you can go to **Logging**→**Firewall**→**IPS** to examine the events.

## Example: Configuring IPS rules via WebGUI

Enable and configure IPS rules from device web interfaces.

**Before you begin:** Make sure you have:

- an active IPS license that supports device-based IPS
- 1. In the device UI, go to **Firewall**→**Advanced Protection**→**IPS**.
- 2. Identify rules to configure:

Choose from:

- Choose rules from the list
  - Filter rules by clicking *[Filter]*
  - Type search terms in the search box
3. Edit or enable rules by clicking *[Edit]*, then setting **Status** to **Enabled**.

You can toggle multiple rules by selecting them, and then clicking →**Quick Settings**,  
**and then setting Status to Enabled**.

**Results:** Selected rules will now be enabled.

**What to do next:** You can check the event log to verify to see actions taken by rules by going to **Diagnostics**→**Event Logs and Notifications**→**Event Log**→**Firewall Log**.

## Introduction to Firewalls

A firewall is a network security device that monitors and controls incoming and outgoing network traffic based on predetermined security rules.

Its primary function is to create a barrier between a private internal network and the public internet, allowing only authorized traffic to pass through and blocking unauthorized access attempts. They use various techniques to filter network traffic, including packet filtering, stateful inspection, and application filtering. Firewalls are an essential component of network security and are used by individuals, small businesses, and large enterprises to protect their networks from various types of cyber threats, such as viruses, malware, hackers, and other malicious attacks.

## Stateful vs. Stateless firewalls

Firewalls can be categorized as either stateful or stateless.

Stateless firewalls, also known as packet filtering firewalls, examine individual packets of data and enforce rules based on information in the packet header, such as source and destination IP addresses or port numbers. Stateless firewalls do not keep track of the state of connections and cannot distinguish between packets belonging to different connections.

Stateful firewalls, on the other hand, keep track of the state of connections and use this information to enforce rules. They can distinguish between packets belonging to different connections and apply more complex security policies. Stateful firewalls maintain a state table that tracks information such as source and destination IP addresses, port numbers, and connection status.

Overall, stateful firewalls offer more advanced security features and are generally more effective at protecting networks from threats. However, they also require more resources and may be more complex to configure and manage. Stateless firewalls are simpler and more lightweight, but may not provide as much protection against advanced threats.

## Categories of Firewall

- Policy (L2,L3~L7) : A policy in firewall function is a set of rules and criteria that are used to determine how traffic is allowed or denied on a network. Firewall policies define the actions that the firewall should take when specific traffic matches the defined criteria. Policies can be used to enact other kinds of filtering, such as:
  - Physical Port Filtering: If unique VLANs are assigned to each port, and L3-7 policies are applied to each VLAN, this has the effect of applying policies to the physical port.
  - High-precision traffic control and QoS: Layer 3-7 policy can be configured to filter out unnecessary traffic, reducing bandwidth waste.
- Malformed packet: The Malformed Packets function enables the device to record event logs with a user-specified severity whenever malformed packets are dropped by the system.
- Session control: Session control in a firewall is the process of tracking and controlling the flow of network traffic between two endpoints in a network session.

Session control to help users protect backend hosts or services and avoid system abnormalities.

- DoS(Denial of Service) policy: The Industrial Secure Router provides 9 different DoS functions for detecting or defining abnormal packet formats or traffic flows. The Industrial Secure Router will drop packets when it either detects an abnormal packet format or identifies unusual traffic conditions.
- Protocol filter policy: The Industrial Secure Router supports industrial protocol filtering, allowing users to inspect network traffic based on specific protocols to detect anomalies and protect your network.

## When to Use Firewalls

Firewalls are a fundamental component of network security and are used to protect networks from unauthorized access and cyber threats. It is a static system that filters traffic based on predefined rules, such as source/destination MAC, IP address or port.

- Prevent unauthorized access to critical assets: Firewalls are used to prevent unauthorized access to critical assets, such as a controller of a system, central monitor system.
- Safeguarding sensitive data: Firewalls are used to safeguard sensitive data such as financial information, healthcare records, and production data.
- Complying with regulations: Many industries are subject to regulations that require the use of firewalls to protect sensitive data.

In summary, firewalls are used to control traffic based on predefined rules and focus on access control. Firewalls are often used in combination with other network secure technique, like IPS (Intrusion Prevention System) to provide comprehensive protection against cyber threats.

## Scenario: Airport Integrated Solutions

A network system provider is configuring a network for an airport.

Airports rely on intricate network systems to enhance efficiency, elevate safety measures, promote environmental sustainability, and reduce operational expenses.



## Sub-Systems in an Airport Network:

A airport network system normally contains several sub-systems to facilitate transportation, such as:

- **Air Traffic Management System (ATMS):** Orchestrates the safe and efficient movement of aircraft.
- **Airport Lighting Control and Monitoring System (ALCMS):** Manages lighting information for approaches, runways, and taxiways.
- **Apron Docking Guide Systems:** Aids aircraft in safe and precise docking at the airport.
- **Apron Management System:** Supervises the activities on the airport apron area, ensuring smooth operations.

## Interoperability and Security

For airports to function seamlessly, these sub-systems must intercommunicate while maintaining security against potential threats. The network should facilitate data sharing for regular flight operations while safeguarding critical systems against intrusions.

## Moxa's Solution

Moxa's secure routers bolster this integration through policy-based firewalls. These policies, composed of specific rules, selectively permit or deny traffic among subsystems. For instance, designers can authorize control signals from ATMS to ALCMS, while excluding potentially disruptive traffic from other parts of the airport.

## Allowlist Firewall Configuration

An allowlist is a network configuration that blocks all traffic except those specifically allowed.

Consider a scenario where the network designer employs dual networks for added redundancy. The firewall's rules can be fine-tuned to:

- Allow the ATMS server to communicate with the ALCMS.
- Reject all unrelated traffic and connections.

To achieve this, set up one or more port filters to allow favorable traffic from recognized devices or ports. Then, set up a "deny all" rule to block any unspecified traffic, allowing the systems coexist securely on a shared network.

Integrating subsystems while preserving security and redundancy requires meticulous design and strategic solutions. With the right tools and approaches, airports can achieve high levels of operational efficiency and safety.

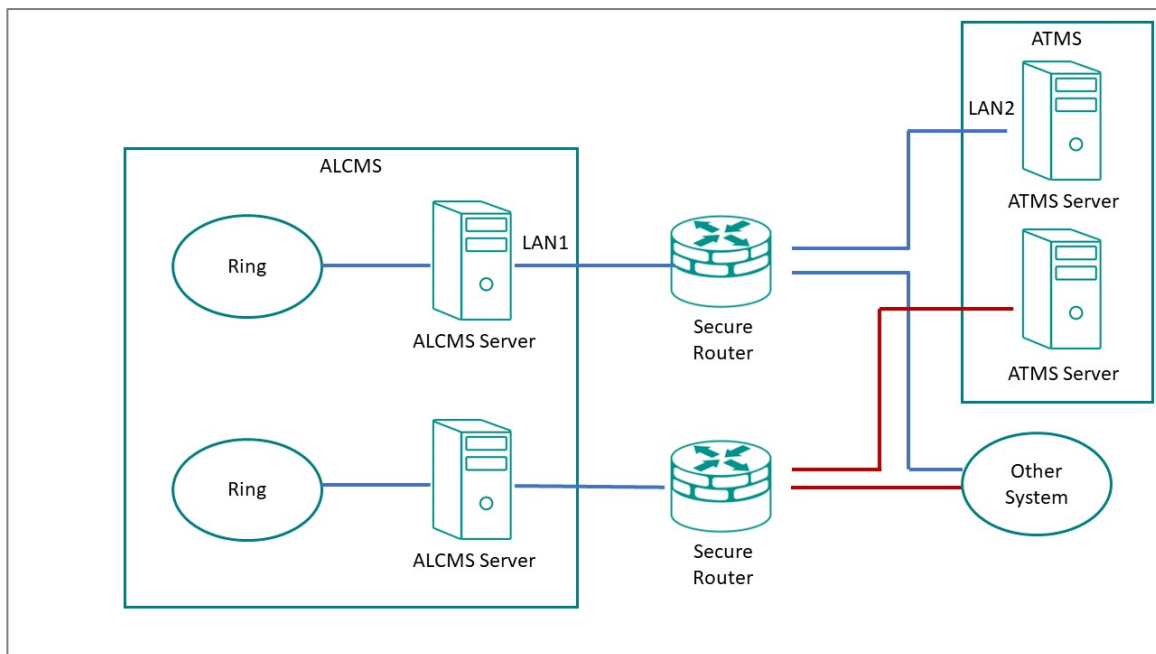

## Example: Allowing ATMS-ALCMS traffic

Create port filtering rules to allow traffic between the ATMS and ALCMS.

This procedure must be used in tandem with a correctly configured "deny all" policy to correctly implement an allowlist.

**Before you begin:** Make sure that network interfaces have already been configured with static IP addresses.

### Note

This example of an allow list relies on fixed IP addresses. Ensure your network is configured accordingly. If the identified characteristics change, the settings will have to be updated.

1. Go to **Firewall** → **Layer 3-7 Policy**, and then click  **[Add]**.

**Result:** The **Layer 3-7 Policy** creation panel appears.

2. Specify all of the following:

| Item                          | Value                                      |
|-------------------------------|--|
| <b>Action</b>                 | <b>Allow</b>                               |
| <b>Filter Mode</b>            | <b>IP and Port Filtering</b>               |
| <b>Source IP Address</b>      | <b>LAN2</b><br>Refers to the ATMS server   |
| <b>Destination IP Address</b> | <b>LAN1</b><br>Refers to the ALCMS server. |

**Tutorial Info:** In this example, these settings identify the "allowed traffic" by IP address. This requires the IP address to be constant. When configuring in a production environment, make sure the characteristics you choose for your filter clearly distinguish trusted and untrusted network objects, such as IP address, protocol and port, or network interface.

 **Note**

Layer 3-7 Policy rules represent a stateful firewall. This means that once the Source initiates traffic with Destination, two-way traffic will be allowed through the firewall because the firewall will remember the "state" of the connection. However, if there is a possibility that either Source or Destination may initiate the connection, it may be best to create separate "mirrored" rules to allow connections in both directions. Refer to Stateful vs. Stateless firewalls for more information.

3. Click **Apply**.

**What to do next:** Add a policy rule to deny all other traffic to and from the ATMS and ALCMS. See Example: Configuring Blocked Traffic (Air)

## Example: Configuring Blocked Traffic (Air)

Once you have specified "allowed" traffic, block all other traffic so that the ATMS and ALCMS systems will be effectively isolated from all other devices.

1. Go to **Firewall** → **Layer 3-7 Policy**, and then click  **[Add]**.

**Result:** The **Layer 3-7 Policy** creation panel appears.

2. In the **Action** field, select **Deny**.

3. In the **Filter Mode** field, select **IP and Port Filtering**.
4. Click **Apply**.
5. Make sure that the "deny all" rule is the last rule on the list, otherwise this rule may override the allow rules.

To reorder rules, click  **[Reorder Priorities]**

**Results:** Traffic between the ATMS and ALCMS systems will be permitted, but all other traffic to and from these systems will be blocked, effectively isolating these systems from other devices on the network. This helps make sure that even if other systems on the network are compromised, no traffic from these systems will reach the ATMS and ALCMS systems, effectively isolating them from this vector of attack.

**What to do next:**

**Tip:** Instead of configuring a "deny all" rule, you can configure a policy from **Global Policy Settings** to deny all traffic. To apply the policy:

1. Go to **Firewall** → **Layer 3-7 Policy**
2. Specify **Status** as **Enabled**.
3. Specify **Default Action** as **Deny All**.
4. Click **Apply**.

Specific rules override generalized policies, effectively making the policy the last rule on the list.

## Scenario: Railway Integrated Solutions

**Short Description:** A network system provider is configuring a network for a railway operator.

### Understanding Railway Network Topology

A typical railway train network comprises multiple sub-systems working in tandem to ensure smooth operations. These sub-systems communicate crucial information, such as train speed, departure/arrival times, door status, climate control, lighting, and station updates to passengers.

Moxa's secure routers offer firewall functionality that allows seamless integration of these systems. By implementing policy-based firewall rules, these routers can permit authorized traffic and block unauthorized exchanges between the different sub-systems.

For instance, the train operating system might consist of various components:

- T2G system (usually a cellular gateway)
- ATO (Automatic Train Operation) system
- TCMS (Train Control and Management System) ring
- PA (Public Announcement system)/PIS (Public Information System) ring
- Control units for each of these systems

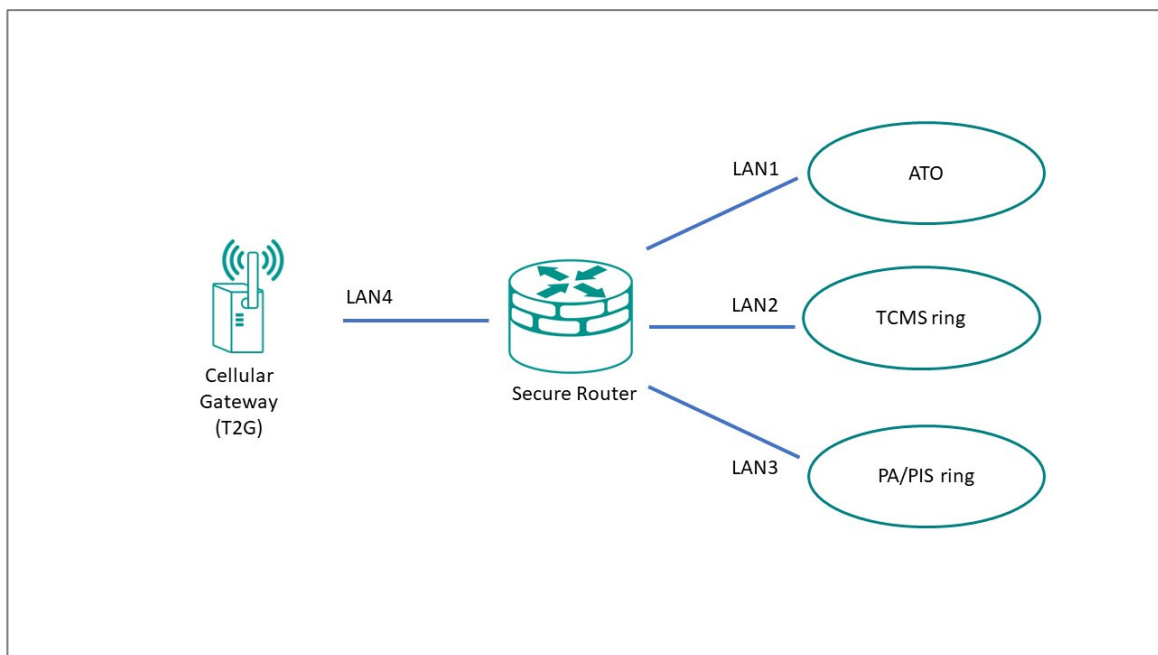

As an example scenario: a network designer might want to configure the network such that the TCMS is the gatekeeper for all signals to the ATO, and prevent the ATO from talking to any other node on the network. We can achieve this kind of network isolation with an allowlist.

## Allowlist Firewall Configuration

An allowlist is a network configuration that blocks all traffic except those specifically allowed.

To apply our example from above, the firewall's rules can be fine-tuned to:

- Allow the TCMS to access the ATO, PA/PIS, and Cellular Gateway.
- Allow the Cellular Gateway to access the TCMS and PA/PIS system.
- Reject all unrelated traffic and connections.

This configuration effectively isolates the ATO from the Cellular Gateway and PA/PIS.

To implement this configuration, set up one or more port filters to allow favorable traffic from recognized devices or ports. Then, set up a "deny all" rule to block any unspecified traffic, allowing the systems coexist securely on a shared network.

Integrating subsystems while preserving security and redundancy requires meticulous design and strategic solutions. With the right tools and approaches, operators can achieve high levels of operational efficiency and safety.

## Example: Allowing TCMS traffic

Create port filtering rules to allow the TCMS to act as a gatekeeper for other devices on the network.

This procedure must be used in tandem with a correctly configured "deny all" policy to correctly implement an allowlist.

**Before you begin:** Make sure that network interfaces have already been configured with static IP addresses.

### Note

This example of an allow list relies on fixed IP addresses. Ensure your network is configured accordingly. If the identified characteristics change, the settings will have to be updated.

1. Go to **Firewall** → **Layer 3-7 Policy**, and then click  **[Add]**.

**Result:** The **Layer 3-7 Policy** creation panel appears.

2. Specify all of the following:

| Item               | Value                        |
|--------------------|------------------------------|
| <b>Action</b>      | <b>Allow</b>                 |
| <b>Filter Mode</b> | <b>IP and Port Filtering</b> |

| Item                          | Value   |
|-------------------------------|---|
| <b>Source IP Address</b>      | LAN2<br>LAN2 should represent the IP address of the TCMS. |
| <b>Destination IP Address</b> | LAN1<br>LAN1 should represent the IP address of the ATO.  |

**Tutorial Info:** In this example, these settings identify the "allowed traffic" by IP address. This requires the IP address to be constant. When configuring in a production environment, make sure the characteristics you choose for your filter clearly distinguish trusted and untrusted network objects, such as IP address, protocol and port, or network interface.

**Note**

Layer 3-7 Policy rules represent a stateful firewall. This means that once the Source initiates traffic with Destination, two-way traffic will be allowed through the firewall because the firewall will remember the "state" of the connection. However, if there is a possibility that either Source or Destination may initiate the connection, it may be best to create separate "mirrored" rules to allow connections in both directions. Refer to Stateful vs. Stateless firewalls for more information.

Tutorial Info: In this case, we will specifically create a bidirectional or "mirrored" rule for TCMS to Cellular Gateway traffic.

3. Create two more **Allow** rules.

| Rule Purpose                                  | Source IP | Destination IP |
|---|-----------|----------------|
| <b>Allow TCMS to PA/PIS Traffic</b>           | LAN2      | LAN3           |
| <b>Allow TCMS to Cellular Gateway Traffic</b> | LAN2      | LAN4           |

4. Click **Apply**.

**Results:** Rules have been created that will allow the TCMS to access all network nodes, allowing the TCMS to serve as a gatekeeper. Next, create a rule that will allow the Cellular Gateway to access the TCMS and PA/PIS. Refer to [Example: Allowing the T2G to access TCMS and PA/PIS](#) for more information.

## Example: Allowing the T2G to access TCMS and PA/PIS

Create port filtering rules to allow traffic from the Cellular Gateway to the TCMS and PA/PIS.

**Before you begin:** Make sure that network interfaces have already been configured with static IP addresses.

 **Note**

This example of an allow list relies on fixed IP addresses. Ensure your network is configured accordingly. If the identified characteristics change, the settings will have to be updated.

1. Go to **Firewall** → **Layer 3-7 Policy**, and then click  **[Add]**.

**Result:** The **Layer 3-7 Policy** creation panel appears.

2. Specify all of the following:

| Item                          | Value  |
|-------------------------------|--|
| <b>Action</b>                 | <b>Allow</b>   |
| <b>Filter Mode</b>            | <b>IP and Port Filtering</b>   |
| <b>Source IP Address</b>      | LAN4<br><b>LAN4</b> should represent the IP address of the Cellular Gateway. |
| <b>Destination IP Address</b> | LAN2<br>LAN2 should represent the IP address of the TCMS.                    |

**Tutorial Info:** In this example, these settings identify the "allowed traffic" by IP address. This requires the IP address to be constant. When configuring in a production environment, make sure the characteristics you choose for your filter clearly distinguish trusted and untrusted network objects, such as IP address, protocol and port, or network interface.

 **Note**

Layer 3-7 Policy rules represent a stateful firewall. This means that once the Source initiates traffic with Destination, two-way traffic will be allowed through the firewall because the firewall will remember the "state" of the connection. However, if there is a possibility that either Source or Destination may initiate the connection, it may be best to create separate "mirrored" rules to allow connections in both directions. Refer to Stateful vs. Stateless firewalls for more information.

3. To allow the Cellular Gateway to access the PA/PIS, specify all of the following:



| Item                          | Value   |
|-------------------------------|---|
| <b>Action</b>                 | <b>Allow</b>  |
| <b>Filter Mode</b>            | <b>IP and Port Filtering</b>  |
| <b>Source IP Address</b>      | LAN4<br>LAN4 should represent the IP address of the Cellular Gateway. |
| <b>Destination IP Address</b> | LAN3<br>LAN3 should represent the IP address of the PA/PIS.           |

4. Click **Apply**.

**Results:** Rules have been created that will allow the Cellular Gateway to access the TCMS and PA/PIS.

**What to do next:** Add a policy rule to block all other traffic. Refer to [Example: Configuring Blocked Traffic \(Rail\)](#) for more information.

## Example: Configuring Blocked Traffic (Rail)

Once you have specified "allowed" traffic, block all other traffic so that the ATO will be effectively isolated from all other devices, relying on the TCMS as a gatekeeper.

1. Go to **Firewall** → **Layer 3-7 Policy**, and then click



**[Add]**.

**Result:** The **Layer 3-7 Policy** creation panel appears.

2. In the **Action** field, select **Deny**.

3. In the **Filter Mode** field, select **IP and Port Filtering**.

4. Click **Apply**.

5. Make sure that the "deny all" rule is the last rule on the list, otherwise this rule may override the allow rules.

To reorder rules, click



### ***[Reorder Priorities]***

**Results:** The TCMS will be able to access all network devices, and the Cellular Gateway will be able to access the TCMS and PA/PIS, but all other traffic will be blocked, effectively isolating these systems from other devices on the network. This helps make sure that even if other systems on the network are compromised, no traffic from these systems will reach the specified systems, effectively isolating them from this vector of attack.

#### ***✎ Note***

Instead of configuring a "deny all" rule, you can configure a policy from Global Policy Settings to deny all traffic. To apply the policy,

1. Go to Firewall → Layer 3-7 Policy
2. Specify Status as Enabled.
3. Specify Default Action as Deny All.
4. Click Apply.

Specific rules override generalized policies, effectively making the policy the last rule on the list.

# Security Standards and Concepts

## AAA

### About AAA - Authentication, Authorization, and Accounting

Authentication, **A**uthorization, and **A**ccounting (AAA) is a user-based access control paradigm.

AAA coexists with other security practices. While product security and network security focus on device or process security, AAA focuses on users.

AAA comprises a set of functions for an administrator to determine which users can access a network device, which services are available to authorized users, and collect information about user activities for audits or charging purposes if required. When implemented well, AAA can provide an extra layer of security across different aspects.

#### Authentication

Authentication provides a method of identifying a user before access to the network device is granted, typically by having the user enter a valid username and password and/or provide a physical token or digital certificate. Additional policies such as a password complexity check or login failure lockout can also increase access security.

#### Authorization

After authentication is successful, a user can be authorized to use specific resources on the device or perform specific operations. For instance, a normal user with limited permissions may only view the device's system settings, whereas an administrator would have full control to view or edit all system settings.

## Accounting

Accounting keeps track of user activities on the device. It monitors the resources a user consumes during network access. This can include the amount of data sent and received through an Ethernet port or the number of user login failures.

## About Authentication Types

Handle authentication with the local device exclusively, or with a remote server using local accounts only as a fallback.

It is important to choose the right authentication method, or combination of authentication methods for your network environment and use case. Moxa devices offer the following authentication options.

### Local Authentication

Local authentication uses the accounts and settings stored on the local network device to identify users (authentication), determine which services they can use (authorization), and track basic user activities such as amount of data transferred or number of login failures (accounting).

### Remote Authentication

Remote authentication uses accounts configured on a RADIUS server - allowing AAA to be configured from a single, centralized location. However, it is important to note that local authentication is retained as a fallback mechanism to ensure the device can be configured if the RADIUS server becomes inaccessible. Additionally, Moxa products support backup RADIUS servers if the primary becomes inaccessible. Due consideration should be given to the configuration and maintenance of backup servers for redundancy.

### Local vs. Remote Authentication Feature Comparison

| Features                      | Local        | Remote                                  |
|-------------------------------|--------------|---|
| <b>Configuration location</b> | Local device | Remote RADIUS server, local as fallback |
| <b>Number of accounts</b>     | Few          | Many                                    |

| Features                              | Local                   | Remote               |
|---------------------------------------|-------------------------|----------------------|
| <b>Password security requirements</b> | Limited                 | Many                 |
| <b>Allowed services*</b>              | Specified locally       | Determined by server |
| <b>Authority types</b>                | Admin, User, Supervisor | Admin, User          |
| <b>User feedback on failed login</b>  | Custom prompt           | Server-defined       |
| <b>Setup effort</b>                   | Low                     | High                 |

\*Allowed services are usually dependent on Authority types.

## Example: Creating a Local User

Local accounts are authenticated and managed by the local device, and function even when remote RADIUS servers are unavailable.

**Before you begin:** Make sure you have an account with **Admin** authority.

In this example, create a local user with simple **User** level authority to fill the Authentication of the AAA tripod. Once the user has been created, add additional access controls.

1. Using an account with **Admin** authority, log in to the network device.
2. Go to **System**→**Account Management**→**User Accounts**, and then click the plus icon.

**Result:** The **Create New Account** panel appears.

3. Set **Status** to **Enabled**.
4. In the **Username** field, type Nick.
5. Set **Authority** as **User**.
6. In the **New Password** field, type 1qaz!@#\$, and then type again to confirm.
7. Click **Create**.

**Results:** By creating the user **Nick**, Authorization and Accounting details can now be configured.

**Create New Account**

Status \*  
Enabled

Username \*  
Nick  
At least 4 characters 4 / 31

Authority \*  
User

New Password \*  
.....  
At least 4 characters 8 / 16

Confirm Password \*  
.....  
At least 4 characters 8 / 16

CANCEL CREATE

**What to do next:** Now that a user account has been created, add account controls. Account controls allow setting a warning for incorrect passwords, account lockouts, and automatic logout. For details, see [Example: Configuring Account Controls for Local Users](#).

### Example: Configuring Account Controls for Local Users

Login Failure Account Lockout and Auto Logout increase the security of local accounts.

Enabling additional account controls can increase resistance to brute-force attacks as well as enable troubleshooting. This example demonstrates how to set account lockouts after failed login attempts and manage idle users.

1. Using an account with **Admin** authority, log in to the network device.
2. Go to **Security**→**Device Security**→**Login Policy**.

**Result:** The **Login Policy** panel appears.

3. In the **Login Authentication Failure Message** field, type Warning! The account will be temporarily locked if there are too many consecutive login failures.
4. Set **Login Failure Account Lockout** to **Enabled**.
5. In the **Login Failure Retry Threshold** field, type 3.

This is the number of failed attempts before the user account will be temporarily blocked.

Temporary bans can help prevent password guessing and brute force attacks by preventing attackers from rapidly guessing many passwords.

6. In the **Lockout Duration** field, type 5.

This specifies the number of minutes the account will be locked.

7. In the **Auto Logout After** field, type 30.

This is the amount of time in minutes before inactive accounts automatically log out.

**Login Policy**

Login Message  
0 / 512

Login Authentication Failure Message  
Warning! The account will be temporarily locked if there are too many consecutive login failures.  
97 / 512

Login Failure Account Lockout  
Enabled

Login Failure Retry Threshold \*  
3  
1 - 10 times

Lockout Duration \*  
5  
1 - 10 min.

Auto Logout After \*  
30  
0 - 1440 min.

**APPLY**

**Results:** This configuration:

- Displays a warning message on failed login attempts, enabling troubleshooting
- Blocks accounts for five minutes after three unsuccessful login attempts, limiting the effectiveness of credential guessing

- Automatically logs out inactive user accounts after thirty minutes, reducing risks of unauthorized access through idle consoles

**What to do next:** Optionally, configure allowed access protocols. For details, see [User Interface](#).

## Example: Configuring a Remote RADIUS Server

In this example, the RADIUS server handles all Authentication, Authorization, and Accounting.

### Before you begin:

- Make sure you have a working RADIUS server and corresponding configuration information. In our example, we use a server that has the following settings:
  - **PAP** authentication protocol
  - An address of 192.168.127.1
  - UDP port 1812
  - A preconfigured shared key

Remote Authentication Dial-In User Service (RADIUS) servers may make it easier to manage large numbers of users from a central location.

1. Using an account with **Admin** authority, log in to the network device.
2. Go to **Security**→**Authentication**→**Login Authentication**, and then set **Authentication Protocol** to **RADIUS, Local**.

**Tutorial Info:** This setting will use the remote RADIUS server as the primary authentication source, and use local authentication as a fallback if the RADIUS server is unavailable.

#### **Note**

Enabling RADIUS authentication will not remove local accounts. Make sure local accounts have a strong, unique password. Local accounts are still required both for RADIUS server configuration as well as for local fallback if the RADIUS server is not reachable. For details, see Example: Creating a Local User.

3. Go to **Security**→**Authentication**→**RADIUS**.

**Result:** The **RADIUS Server** will appear.

4. Configure all of the following:



| Field                      | Setting                     |
|----------------------------|-----------------------------|
| <b>Authentication Type</b> | <b>PAP</b>                  |
| <b>Server Address 1</b>    | 192.168.127.1               |
| <b>UDP Port</b>            | 1812                        |
| <b>Shared Key</b>          | Enter your Shared Key here. |

**Tutorial Info:** These configuration options are provided as an example only, and will need to match your network environment.

5. Click **Apply**.

### Results:

By configuring remote authentication, the network device will redirect user login requests to the RADIUS server. When logging in with remote user Peter, the RADIUS server will process the authentication request and determine whether to grant access to the device. If Peter does not match RADIUS or Local information, access will be denied.

In situations where the RADIUS server is not reachable or unavailable, users such as Nick (created in Example: Creating a Local User or other existing local users can still access the network device using their local passwords.

#### Note

If RADIUS is enabled, but unreachable, network-based logins (HTTP/HTTPS/Telnet/SSH) will not be possible, and users will be limited to logins through the console port only.

### RADIUS Server

Authentication Type \*  
PAP ▼

|                  |          |
|------------------|----------|
| Server Address 1 | UDP Port |
| 0 / 63           | 1812     |
| 1 - 65535        |          |

Shared Key 🔒

0 / 60

|                  |          |
|------------------|----------|
| Server Address 2 | UDP Port |
| 0 / 63           | 1812     |
| 1 - 65535        |          |

Shared Key 🔒

0 / 60

APPLY

## ISA/IEC 62443 Standards and Architecture

### Security Reference Standards

In the field, large networks are connected through switches and routers. These devices manage all data traffic and serve as the main bridge between devices. However, if these switches and routers are compromised, the repercussions can cascade to all connected devices. To help mitigate this risk, Moxa implements the ISA/IEC 62443-4-2 standard into our network device designs.

### Security Standards and Vertical Markets

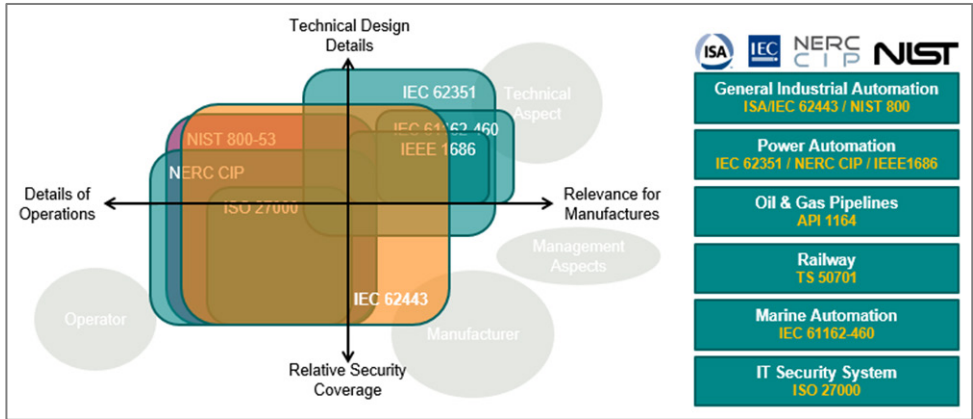

Industries such as electricity, oil and gas, rail transportation, and maritime have established their own standards for security. These standards include guidelines and regulations designed to address each industry's unique concerns. Among these standards, 62443 is the most comprehensive, covering a wide range of industries and security concerns, making it an excellent choice for organizations that prioritize security in their operations.

### ISA/IEC 62443 Standards and Architecture

The ISA/IEC 62443 standard is a set of guidelines and best practices designed to help organizations secure their industrial automation and control systems (IACS) against cyber threats. The framework helps assess risks to IACS and implement appropriate security measures to protect against cyber attacks and malware. The standard consists of multiple parts, with each covering different aspects of industrial cybersecurity.

#### Breakdown of ISA/IEC 62443

| Parts of ISA/IEC 62443 | Scope   | Sections  |
|------------------------|---------|---|
| <b>ISA/IEC 62443-1</b> | General | Part 1-1: Terminology, concepts, and models<br>Part 1-2: Master glossary of terms and abbreviations<br>Part 1-3: System security compliance metrics<br>Part 1-4: IACS security life cycle and use-cases |

| Parts of ISA/IEC 62443 | Scope                            | Sections  |
|------------------------|----------------------------------|---|
| <b>ISA/IEC 62443-2</b> | Process and Program requirements | Part 2-1: Establishing an industrial automation and control system security program<br>Part 2-2: Implementation guidance for an IACS security management system<br>Part 2-3: Patch management in the IACS environment<br>Part 2-4: Security program requirements for IACS service providers |
| <b>ISA/IEC 62443-3</b> | Systems                          | Part 3-1: Security technologies for industrial automation and control systems<br>Part 3-2: Security risk assessment and system design<br>Part 3-3: System security requirements and security levels   |
| <b>ISA/IEC 62443-4</b> | Components                       | Part 4-1: Secure product development lifecycle requirements<br>Part 4-2: Technical security requirements for IACS components  |

Product suppliers adhere to the ISA/IEC 62443 standard to provide components for Industrial Automation and Control System (IACS) solutions. These components can be:

- Individual items
- Combined products forming a system or subsystem

Additionally, system integrators use the following sections of the ISA/IEC 62443 standard:

- IEC 62443-2-1
- IEC 62443-2-4
- IEC 62443-3-2
- IEC 62443-3-3

These standards help integrators:

- Determine security zones
- Specify security capability levels for each zone
- Integrate products into an Automation Solution

### **Key Parts of ISA/IEC 62443 Standard**

| Parts of the ISA/IEC 62443 Standard        | Technical Security Requirements                      |
|--|--|
| <b>General</b><br><b>ISA/IEC 62443-1</b>   | ISA-/IEC 62443-1-1<br>Foundational Requirements (FR) |
| <b>System</b><br><b>ISA/IEC 62443-3</b>    | ISA-/IEC 62443-3-3<br>System Requirements (SR)       |
| <b>Component</b><br><b>ISA/IEC 62443-4</b> | ISA-/IEC 62443-4-2<br>Component Requirements (CR)    |

Once the solution is ready, it's installed on-site, becoming a vital part of the IACS.

### Summary of IEC 62443 Stakeholders

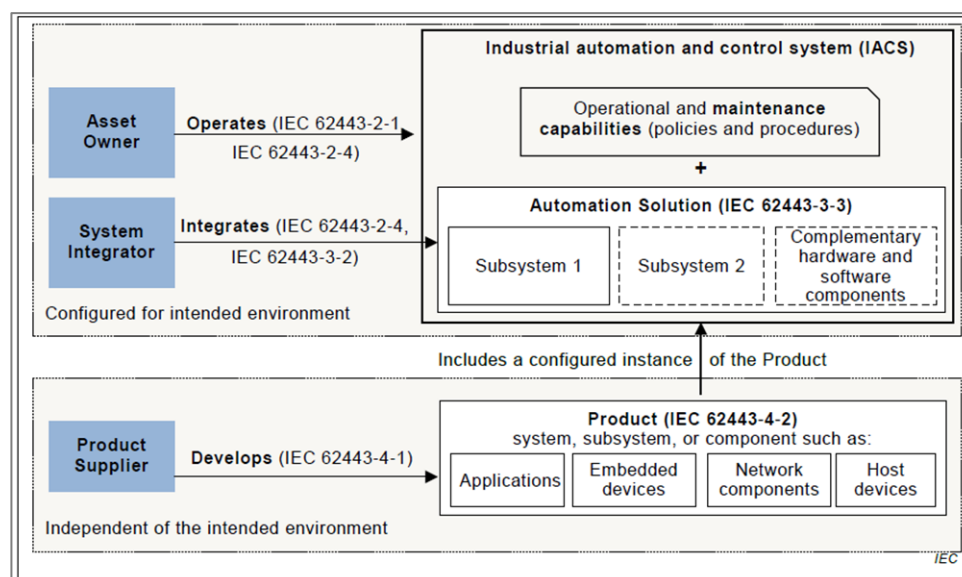

## Establishing Foundational Requirements

### ISA/IEC 62443-1-1 Foundational Requirements (FR)

| FR 1 | Identification and Authentication Control |
|------|---|
| FR 2 | User Control                              |
| FR 3 | System Integrity                          |

| FR 1 | Identification and Authentication Control |
|------|---|
| FR 4 | Data Confidentiality                      |
| FR 5 | Restricted Data Flow                      |
| FR 6 | Timely Response to Events                 |
| FR 7 | Resource Availability                     |

Once an organization settles on target security levels, foundational requirements can help further specify requirements based on the seven foundational security functions (FRs). The ISA/IEC 62443 framework includes:

- **System Requirements (SRs):** Detailed in Part 3-3, these are guidelines for those shaping the system's overall architecture.
- **Component Requirements (CRs):** Outlined in Part 4-2, they cater to designers focusing on individual components.

Both system and component designers reference these standards, ensuring the final product's security aligns with what the asset owner's requirements. This methodology not only bolsters the product's defense against specific threat levels but also optimizes resource utilization among stakeholders. As a side note, every FR from Part 1-1 is paired with four distinct security levels, which trace back to standards set in Parts 3-3 and 4-2. For simplicity in cross-referencing, CRs are numerically aligned with their corresponding SRs.

## Component Requirements

Part 4-2 extends the SRs from Part 3-3 by introducing CRs tailored for a variety of IACS components.

These components fall under four broad categories of SRs:

- Software Applications
- Embedded Devices
- Host Devices
- Network Devices

While a majority of Part 4-2's criteria are generic and apply uniformly across categories, there are exceptions. Unique, component-specific stipulations are clearly signposted, with exhaustive details available in dedicated clauses. For details, consult the original standards.

## Requirement Enhancements

CRs may contain one or more requirement enhancements (RE). REs are additional requirements attached to CRs that add additional conditions to accommodate higher security levels.

## FR 1 Applications: User Identification and Authentication

FR 1 codifies the principle that all users—humans, software processes, or devices—must first be identified and authenticated before accessing the system or assets.

Recognizing the need to verify different kinds of users, FR 1 uses the following CRs:

- **CR 1.1** focuses on human users.
- **CR 1.2** addresses software processes and devices.

**Identification vs. Authentication:** Consider a person's ID card. While the card identifies its owner, can someone else misuse it? Certainly. Here, the distinction between 'identifying' (matching a person to an ID card) and 'authenticating' (confirming the card holder's authenticity) becomes crucial. Each process has distinct methods and requirements.

**Understanding CR and RE in Determining Security Levels:** CR represents foundational requirements, whereas RE accounts for advanced needs. Together, they define the security capacity of a component. Each component's security level, according to FR, ranges from 0 (no requirements) to 4.

For instance:

- **Security Level 1:** Implementing basic identification and authentication for all human users.
- **Security Level 2:** Incorporates RE1 - uniquely identify and authenticate users, like using ID cards for employees.
- **Security Level 3:** Engages RE2 - multifactor authentication.

**Multifactor Authentication Unraveled:** Typically, this methodology hinges on:

1. **Knowledge:** Passwords or PINs.
2. **Possession:** Devices like smartphones or security keys.
3. **Inherence:** Biometrics such as fingerprints.

To achieve Level 3, a combination of at least two of these factors is essential.

### Security Levels (SLs) and Attack Types

| Security Level | Example Threat Actor  | Violation Type | Means         | Resource Level | Motivation |
|----------------|---|----------------|---------------|----------------|------------|
| <b>SL-1</b>    | <ul style="list-style-type: none"> <li>• Ordinary user</li> </ul>                                     | Coincidental   | N/A           | N/A            | N/A        |
| <b>SL-2</b>    | <ul style="list-style-type: none"> <li>• Entry-level hacker</li> </ul>                                | Intentional    | Simple        | Low            | Low        |
| <b>SL-3</b>    | <ul style="list-style-type: none"> <li>• Terrorist Organization</li> <li>• Organized crime</li> </ul> | Intentional    | Sophisticated | Moderate       | Moderate   |
| <b>SL-4</b>    | <ul style="list-style-type: none"> <li>• Nation state</li> </ul>                                      | Intentional    | Sophisticated | Extended       | High       |

For more information about CRs, SLs, and REs, refer to the ISA/IEC 62443 standard.

## Product Lifecycle and Security

Component security plays a role throughout the product lifecycle.

### Moxa's Application of ISA/IEC 62443-4-1

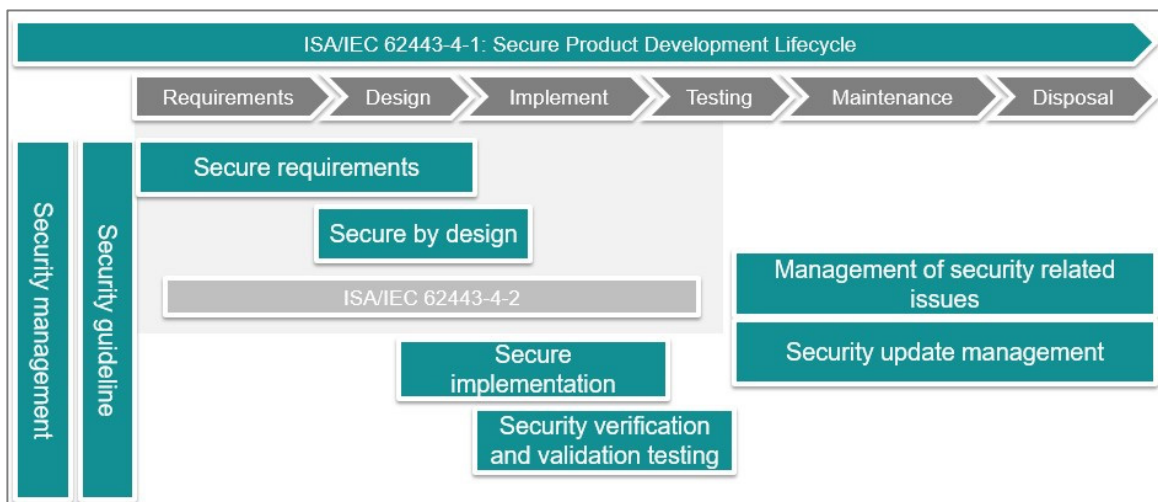



## **How Moxa applies ISA/IEC 62443-4-1**

Our commitment to security includes adhering to the ISA/IEC 62443-4-1 standard, considering security at each stage of the product's lifecycle. This includes the safeguarding of our corporate network, keys, secure design and implementation proficiencies, testing processes, and post-sales services. Our approach involves extensive training and certification of all team members associated with product design, execution, and assistance. Moreover, we offer robust support mechanisms like vulnerability handling and patch management.

## **Component Security with IEC 62443-4-2**

IEC 62443-4-2 serves as a guide for product suppliers, helping us decipher the specific security capability benchmarks for control system components. This standard not only clarifies which requirements should be assigned but also pinpoints those that must be integral to the components. The fusion of these component requirements with their enhancement requirements defines the component's target security level.

## **Product Security Context**

Security context describes a product's role in a network and the security features of its environment.

# Security Context of an Industrial Secure Router

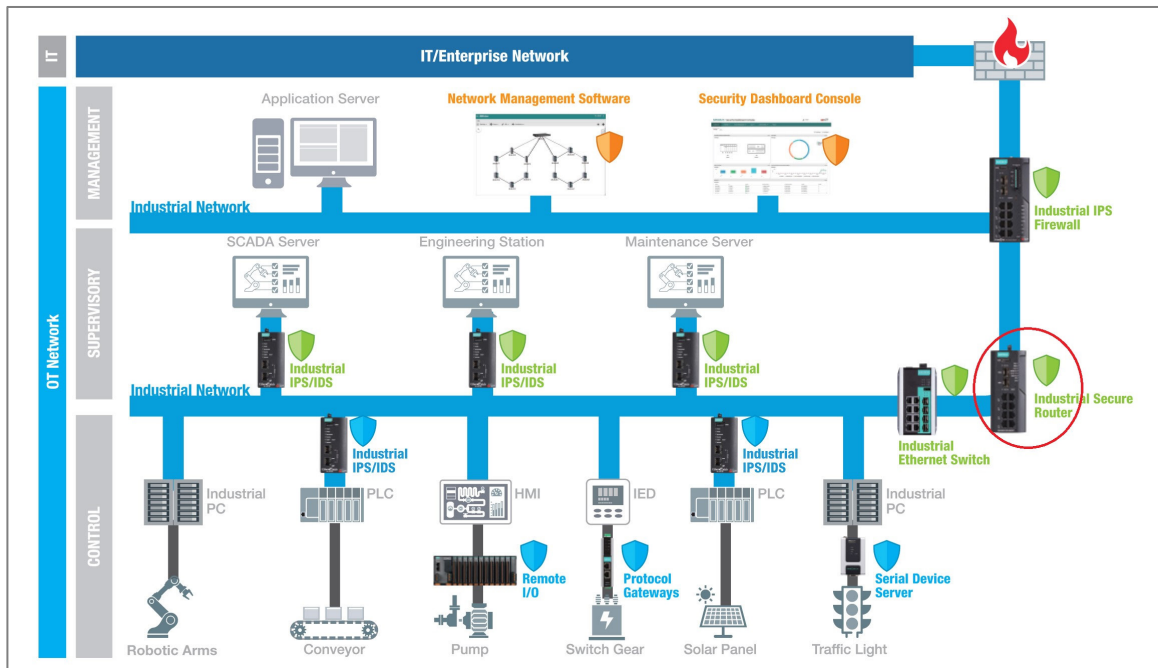

A secure router is a router with security features. Unlike a firewall—which exclusively filters and controls traffic—a secure router also monitors connections between devices. Secure routers have additional security features such as intrusion detection/prevention systems (IDS/IPS), virtual private network (VPN) support, and advanced encryption capabilities.

Secure router Intrusion Detection Systems (IDS) can be deployed behind the firewall for a defense-in-depth approach, increasing detection of attacks bypassing first-layer firewalls.

# Security Context of an Industrial Ethernet Switch

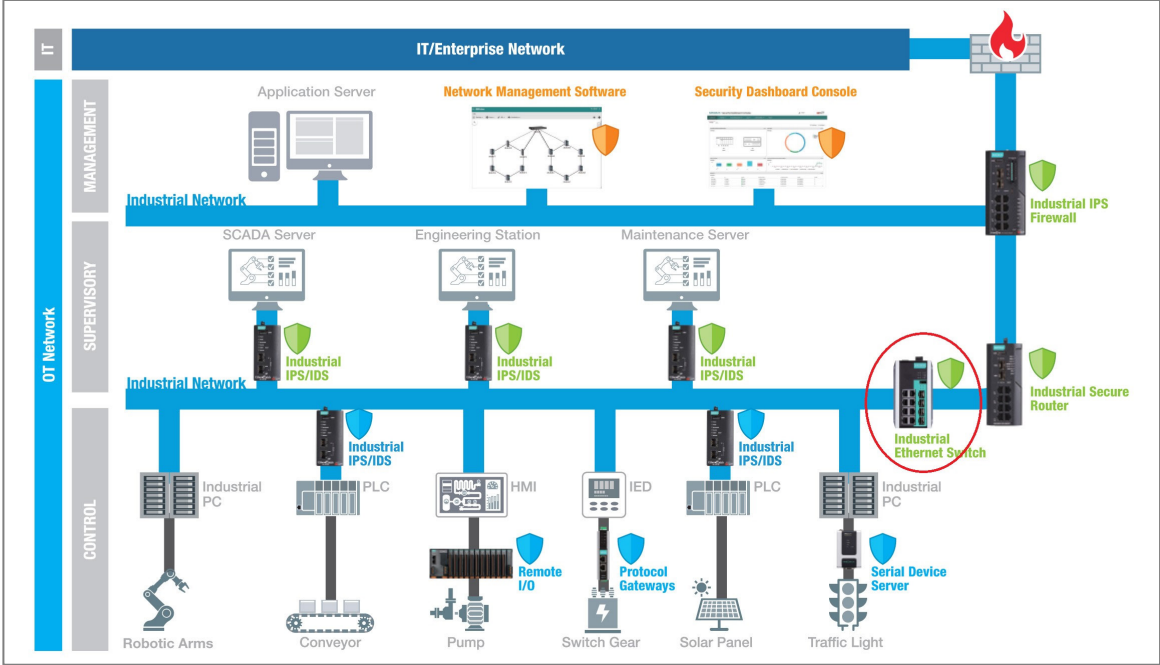

Switches with enhanced security features such as access control lists (ACLs), VLAN support, and support for secure communication protocols, in conjunction with other security measures, can help create a more robust and resilient network.

ACLs and VLANs can help isolate devices on the same physical or logical network segments. This isolation adds further security to minimize or mitigate the effects of an attack.

# Chapter 8

---

# Appendix

# All Settings for Example Scenario: 2 Consists with 1 ETBN/ECSP Each

All Settings for Example Scenario: 2 Consists with 2 Redundant ETBN routers

| Consist                         | Consist 1  | Consist 2                            |
|---------------------------------|--|--------------------------------------|
| <b>ETBN Router</b>              | ETBN Router 1  | ETBN Router 1                        |
| <b>ETB Backbone ID</b>          | <b>0</b><br>This field identifies the type of traffic carried by the ETB, and should be the same within the same ETB.<br>Since both ETBNs are in the same ETB, their ETB backbone IDs are the same.  |                                      |
| <b>Consist UUID</b>             | 00000000-0000-0000-0000-000000000001   | 00000000-0000-0000-0000-000000000002 |
|                                 | The UUID is the same within the same consist. The example UUID is manually assigned, but they can also be randomly generated.  |                                      |
| <b>ETBN(s) in Consist</b>       | <b>1</b><br>Dictated by our sample topology.   |                                      |
| <b>ECN(s) in Consist</b>        | <b>1</b><br>Multi-application consists might have additional ECNs to support additional applications - such as having both TCMS and Media - but our example is limited to 1 for now.   |                                      |
| <b>Local ETBN Static ID</b>     | <b>1</b><br>Identifies the ETBN when there are multiple ETBNs in the same consist.   |                                      |
| <b>ECN interface IP address</b> | 10.0.0.1<br>Defines the IP of the ECN interface. Devices in the ECN network can access the ETBN using the ECN interface IP.<br>Use caution when setting this as the default gateway. Because this example uses redundant ETBNs, if the primary ETBN fails and the backup takes over, the gateway IP address changes. You can avoid disruptions to cross-consist communication by leveraging VRRP. Refer to <a href="#">Redundancy &gt; Layer 3 Redundancy &gt; VRRP</a> for more information about VRRP. |                                      |
| <b>Direction 1</b>              | <b>Trunk 1</b><br>In TN-4908, port 1,2 will be set as trunk 1, and port 5,6 will be set as trunk 2. Important: The direction of all ETBNs in the same consist should be the same.  |                                      |
| <b>Direction 2</b>              | <b>Trunk 2</b>   |                                      |

| Consist                         | Consist 1                             | Consist 2  |
|---------------------------------|---------------------------------------|--|
| <b>ETB Port Speed</b>           | Auto                                  |  |
| <b>ECN Port VLAN ID</b>         | 1000                                  | Defines the VLAN ID of the ETB interface. The TTDP function will generate the corresponding ETB and ECN interface.   |
| <b>ECN to ETBN</b>              | <b>ETBN 1</b>                         |  |
| <b>ECN interface IP address</b> | 10.0.0.1                              | Defines the IP of the ECN interface. Devices in the ECN network can access the ETBN using the ECN interface IP.<br><br>Use caution when setting this as the default gateway. Because this example uses redundant ETBNs, if the primary ETBN fails and the backup takes over, the gateway IP address changes. You can avoid disruptions to cross-consist communication by leveraging VRRP. Refer to <a href="#">Redundancy &gt; Layer 3 Redundancy &gt; VRRP</a> for more information about VRRP. |
| <b>ECN Ports</b>                | <b>port3, port4, port7, and port8</b> | The field is to define which ports on the TN-4900 are the ECN ports. These selected ports will be assigned to the ECN interface.   |

# All Settings for Example Scenario: 2 Consists with 2 Redundant ETBN Routers Each

All Settings for Example Scenario: 2 Consists with 2 Redundant ETBN routers

| Consist                     | Consist 1   |               | Consist 2                            |               |
|-----------------------------|---|---------------|--------------------------------------|---------------|
| <b>ETBN Router</b>          | ETBN Router 1   | ETBN Router 2 | ETBN Router 1                        | ETBN Router 2 |
| <b>ETB Backbone ID</b>      | <b>0</b><br>This field identifies the type of traffic carried by the ETB, and should be the same within the same ETB.<br>Since both ETBNs are in the same ETB, their ETB backbone IDs are the same. |               |                                      |               |
| <b>Consist UUID</b>         | 00000000-0000-0000-0000-000000000001  |               | 00000000-0000-0000-0000-000000000002 |               |
|                             | The UUID is the same within the same consist. The example UUID is manually assigned, but they can also be randomly generated.   |               |                                      |               |
| <b>ETBN(s) in Consist</b>   | <b>2</b><br>Dictated by our sample topology.  |               |                                      |               |
| <b>ECN(s) in Consist</b>    | <b>1</b><br>Multi-application consists might have additional ECNs to support additional applications - such as having both TCMS and Media - but our example is limited to 1 for now.                |               |                                      |               |
| <b>Local ETBN Static ID</b> | <b>1</b>  | <b>2</b>      | <b>1</b>                             | <b>2</b>      |
|                             | Identifies the ETBN when there are multiple ETBNs in the same consist.  |               |                                      |               |
| <b>Direction 1</b>          | <b>Trunk 1</b><br>In TN-4908, port 1,2 will be set as trunk 1, and port 5,6 will be set as trunk 2.<br>Important: The direction of all ETBNs in the same consist should be the same.                |               |                                      |               |
| <b>Direction 2</b>          | <b>Trunk 2</b>  |               |                                      |               |
| <b>ETB Port Speed</b>       | Auto  |               |                                      |               |
| <b>ECN Port VLAN ID</b>     | 1001  |               |                                      |               |

| Consist                         | Consist 1   |          | Consist 2 |          |
|---------------------------------|---|----------|-----------|----------|
| <b>ECN interface IP address</b> | 10.0.0.1  | 10.0.0.2 | 10.0.0.1  | 10.0.0.2 |
|                                 | <p>Defines the IP of the ECN interface. Devices in the ECN network can access the ETBN using the ECN interface IP.</p> <p>Use caution when setting this as the default gateway. Because this example uses redundant ETBNs, if the primary ETBN fails and the backup takes over, the gateway IP address changes. You can avoid disruptions to cross-consist communication by leveraging VRRP. Refer to <a href="#">Redundancy &gt; Layer 3 Redundancy &gt; VRRP</a> for more information about VRRP.</p> |          |           |          |
| <b>ECN Ports</b>                | <p><b>port3, port4, port7, and port8</b></p> <p>The field is to define which ports on the TN-4900 are the ECN ports. These selected ports will be assigned to the ECN interface.</p>  |          |           |          |



# Destination Ports for Layer 3 – 7

## Protocol

### Network Service

**Remote-Access**

**Remote-Desktop**

**Email**

**File-Transfer**

**Web-Access**

**Network-Service**

**Authentication**

**VOIP-and-Streaming**

**SQL-Server**

### Industrial Application Service

**Modbus**

**DNP3**

**IEC-60870-5-104**

**IEC-61850-MMS**

**OPC-DA**

**OPC-UA**

**CIP-EtherNet/IP**

**Siemens-Step7**

**Moxa-RealCOM**



# Ethernet Protocol Default Ports

This table shows the default ports used for various Ethernet protocols.

| Ethernet Protocol                              | Port Number |
|--|-------------|
| <b>DNP3 (TCP)</b>                              | 20000       |
| <b>DNP3 (UDP)</b>                              | 20000       |
| <b>Ethercat (TCP)</b>                          | 34980       |
| <b>Ethercat (UDP)</b>                          | 34980       |
| <b>EtherNet/IP I/O (TCP)</b>                   | 2222        |
| <b>EtherNet/IP I/O (UDP)</b>                   | 2222        |
| <b>EtherNet/IP messaging (TCP)</b>             | 44818       |
| <b>EtherNet/IP messaging (UDP)</b>             | 44818       |
| <b>FF Annunciation (TCP)</b>                   | 1089        |
| <b>FF Annunciation (UDP)</b>                   | 1089        |
| <b>FF Fieldbus Message Specification (TCP)</b> | 1090        |
| <b>FF Fieldbus Message Specification (UDP)</b> | 1090        |
| <b>FF LAN Redundancy Port (TCP)</b>            | 3622        |
| <b>FF LAN Redundancy Port (UDP)</b>            | 3622        |
| <b>FF System Management (TCP)</b>              | 1091        |
| <b>FF System Management (TCP)</b>              | 1091        |
| <b>FTP-control (TCP)</b>                       | 21          |
| <b>FTP-control (UDP)</b>                       | 21          |
| <b>FTP-data (TCP)</b>                          | 20          |
| <b>FTP-data (UDP)</b>                          | 20          |

| <b>Ethernet Protocol</b>                             | <b>Port Number</b> |
|--|--------------------|
| <b>HTTP (TCP)</b>                                    | 80                 |
| <b>HTTP (UDP)</b>                                    | 80                 |
| <b>IEC 60870-5-104 process control over IP (TCP)</b> | 2404               |
| <b>IEC 60870-5-104 process control over IP (UDP)</b> | 2404               |
| <b>IPsec (TCP)</b>                                   | 1293               |
| <b>IPsec (UDP)</b>                                   | 1293               |
| <b>IPsec NAT-Traversal (TCP)</b>                     | 4500               |
| <b>IPsec NAT-Traversal (UDP)</b>                     | 4500               |
| <b>L2TP (TCP)</b>                                    | 1701               |
| <b>L2TP (UDP)</b>                                    | 1701               |
| <b>LonWorks (TCP)</b>                                | 2540               |
| <b>LonWorks (UDP)</b>                                | 2540               |
| <b>LonWorks2 (TCP)</b>                               | 2540               |
| <b>LonWorks2 (UDP)</b>                               | 2540               |
| <b>Modbus TCP/IP (TCP)</b>                           | 502                |
| <b>Modbus TCP/IP (UDP)</b>                           | 502                |
| <b>PPTP (TCP)</b>                                    | 1723               |
| <b>PPTP (UDP)</b>                                    | 1723               |
| <b>PROFINet Context Manager (TCP)</b>                | 34964              |
| <b>PROFINet Context Manager (UDP)</b>                | 34964              |
| <b>PROFINet RT Multicast (TCP)</b>                   | 34963              |
| <b>PROFINet RT Multicast (UDP)</b>                   | 34963              |
| <b>PROFINet RT Unicast (TCP)</b>                     | 34962              |

| <b>Ethernet Protocol</b>         | <b>Port Number</b> |
|----------------------------------|--------------------|
| <b>PROFINet RT Unicast (UDP)</b> | 34962              |
| <b>RADIUS (TCP)</b>              | 1812               |
| <b>RADIUS (UDP)</b>              | 1812               |
| <b>RADIUS Accounting (TCP)</b>   | 1813               |
| <b>RADIUS Accounting (UDP)</b>   | 1813               |
| <b>SSH (TCP)</b>                 | 22                 |
| <b>SSH (UDP)</b>                 | 22                 |
| <b>Telnet (TCP)</b>              | 23                 |
| <b>Telnet (UDP)</b>              | 23                 |

# EtherTypes for Layer 2

The following table shows the Layer 2 protocol types commonly used in Ethernet frames.

| EtherType Value (Hexadecimal) | Layer 2 Protocol                   |
|-------------------------------|------------------------------------|
| <b>0x0800</b>                 | IPv4 (Internet Protocol version 4) |
| <b>0x0805</b>                 | X25                                |
| <b>0x0806</b>                 | ARP (Address Resolution Protocol)  |
| <b>0x0808</b>                 | Frame Relay ARP                    |
| <b>0x08FF</b>                 | G8BPQ AX.25 Ethernet Packet        |
| <b>0x6000</b>                 | DEC Assigned proto                 |
| <b>0x6001</b>                 | DEC DNA Dump/Load                  |
| <b>0x6002</b>                 | DEC DNA Remote Console             |
| <b>0x6003</b>                 | DEC DNA Routing                    |
| <b>0x6004</b>                 | DEC LAT                            |
| <b>0x6005</b>                 | DEC Diagnostics                    |
| <b>0x6006</b>                 | DEC Customer use                   |
| <b>0x6007</b>                 | DEC Systems Comms Arch             |
| <b>0x6558</b>                 | Trans Ether Bridging               |
| <b>0x6559</b>                 | Raw Frame Relay                    |
| <b>0x80F3</b>                 | Appletalk AARP                     |
| <b>0x809B</b>                 | Appletalk                          |
| <b>0x8100</b>                 | 8021Q VLAN tagged frame            |
| <b>0x8137</b>                 | Novell IPX                         |
| <b>0x8191</b>                 | NetBEUI                            |

| EtherType Value (Hexadecimal) | Layer 2 Protocol                           |
|-------------------------------|--|
| <b>0x86DD</b>                 | IP version 6 (Internet Protocol version 6) |
| <b>0x880B</b>                 | PPP  |
| <b>0x884C</b>                 | MultiProtocol over ATM                     |
| <b>0x8863</b>                 | PPPoE discovery messages                   |
| <b>0x8864</b>                 | PPPoE session messages                     |
| <b>0x8884</b>                 | Frame-based ATM Transport over Ethernet    |
| <b>0x9000</b>                 | Loopback                                   |

# Fiber Check Threshold Values

| Model Name           | Temperature Threshold (°C) | Tx Power (Threshold Low/High) (dBm) | Rx Power (Threshold Low/High) (dBm) |
|----------------------|----------------------------|-------------------------------------|-------------------------------------|
| <b>FEMST</b>         | 120                        | -14/-20                             | -3.0/-32.0                          |
| <b>FEMSC</b>         | 120                        | -14/-20                             | -3.0/-32.0                          |
| <b>FESSC</b>         | 120                        | 0.0/-5.0                            | -3.0/-34.0                          |
| <b>SFP-1FEMLC-T</b>  | 120                        | -8.0/-18.0                          | -3.0/-32.0                          |
| <b>SFP-1FESLC-T</b>  | 120                        | 0.0/-5.0                            | -3.0/-34.0                          |
| <b>SFP-1FELLC-T</b>  | 120                        | 0.0/-5.0                            | -3.0/-34.0                          |
| <b>SFP-1GSXLC-T</b>  | 110                        | -4.0/-9.5                           | 0.0/-18.0                           |
| <b>SFP-1GLSXLC-T</b> | 120                        | -1.0/-9.0                           | -1.0/-19.0                          |
| <b>SFP-1GLXLC-T</b>  | 120                        | -3.0/-9.0                           | -3.0/-21.0                          |
| <b>SFP-1GLHLC-T</b>  | 120                        | -3.0/-8.0                           | -3.0/-23.0                          |
| <b>SFP-1GLHXLC-T</b> | 120                        | 3.0/-4.0                            | -1.0/-24.0                          |
| <b>SFP-1GZXLC-T</b>  | 120                        | 5.0/0.0                             | -1.0/-24.0                          |
| <b>SFP-1G10ALC-T</b> | 120                        | -3.0/-9.0                           | -3.0/-21.0                          |
| <b>SFP-1G10BLC-T</b> | 120                        | -3.0/-9.0                           | -3.0/-21.0                          |
| <b>SFP-1G20ALC-T</b> | 120                        | -2.0/-8.0                           | -2.0/-23.0                          |
| <b>SFP-1G20BLC-T</b> | 120                        | -2.0/-8.0                           | -2.0/-23.0                          |



| Model Name             | Temperature Threshold (°C) | Tx Power (Threshold Low/High) (dBm) | Rx Power (Threshold Low/High) (dBm) |
|------------------------|----------------------------|-------------------------------------|-------------------------------------|
| <b>SFP-1G40ALC-T</b>   | 120                        | 2.0/-3.0                            | -1.0/-23.0                          |
| <b>SFP-1G40BLC-T</b>   | 120                        | 2.0/-3.0                            | -1.0/-23.0                          |
| <b>SFP-1GSXLC</b>      | 100                        | -4.0/-9.5                           | 0.0/-18.0                           |
| <b>SFP-1GLSXLC</b>     | 100                        | -1.0/-9.0                           | -1.0/-19.0                          |
| <b>SFP-1GLXLC</b>      | 100                        | -3.0/-9.0                           | -3.0/-21.0                          |
| <b>SFP-1GLHLC</b>      | 100                        | -3.0/-8.0                           | -3.0/-23.0                          |
| <b>SFP-1GLHXLC</b>     | 100                        | 3.0/-4.0                            | -1.0/-24.0                          |
| <b>SFP-1GZXLC</b>      | 100                        | 5.0/0.0                             | -1.0/-24.0                          |
| <b>SFP-1GEZXLC</b>     | 100                        | 5.0/0.0                             | -9.0/-30.0                          |
| <b>SFP-1GEZXLC-120</b> | 100                        | 3.0/-2.0                            | -8.0/-33.0                          |
| <b>SFP-1G10ALC</b>     | 100                        | -3.0/-9.0                           | -3.0/-21.0                          |
| <b>SFP-1G10BLC</b>     | 100                        | -3.0/-9.0                           | -3.0/-21.0                          |
| <b>SFP-1G20ALC</b>     | 100                        | -2.0/-8.0                           | -2.0/-23.0                          |
| <b>SFP-1G20BLC</b>     | 100                        | -2.0/-8.0                           | -2.0/-23.0                          |
| <b>SFP-1G40ALC</b>     | 100                        | 2.0/-3.0                            | -1.0/-23.0                          |
| <b>SFP-1G40BLC</b>     | 100                        | 2.0/-3.0                            | -1.0/-23.0                          |
| <b>SFP-2.5GMLC-T</b>   | 120                        | -1.0/-7.5                           | 0.0/-13.5                           |
| <b>SFP-2.5GSLC-T</b>   | 120                        | -3.0/-9.0                           | -3.0/-15.0                          |
| <b>SFP-2.5GLSLC-T</b>  | 120                        | 0.0/-5.0                            | 0.0/-16.0                           |
| <b>SFP-2.5GSLHLC-T</b> | 120                        | 1.0/-4.0                            | 1.0/-19.0                           |



# Glossary

## 1-to-1 NAT

1-to-1 NAT maps one public IP address to one private IP address.

## Broadcast Forwarding

Broadcast forwarding enables users to specify the interface and UDP ports that broadcast packets will use to pass through the router, allowing devices to be queried on the network, such as Modbus devices.

## CoS Mapping

CoS stands for Class of Service and refers to the differentiation and marking of different types of data during network transmission to distinguish between different types of services. CoS mapping is the process of mapping CoS levels to priority queues on the device.

## Dead Interval

The dead interval is the amount of time a device will wait for a hello packet. If a hello packet is not received in this time, it will consider the other device to be dead or unavailable. By default, the dead interval is set to be four times the value of the hello interval.

## Double NAT

Double NAT enables you to use 1-to-1 rules to facilitate two-way communication.

## **DSCP Mapping**

DSCP is a field in the IP Layer 3 header that allows network administrators to classify and prioritize traffic based on the type of service being provided, ensuring that critical traffic receives priority handling and network resources are utilized efficiently. DSCP mapping is the process of mapping DSCP levels to priority queues on the device.

## **Hello Interval**

The hello interval is the amount of time between sends of hello packets, which indicate that the device is still alive. The value of all hello intervals must be the same within a network.

## **Hello Packet**

Hello packets are packets that an OSPF process sends to its OSPF neighbors to maintain connectivity with those neighbors. Hello packets are sent at a configurable interval (in seconds).

## **IEC 61735**

IEC 61375 is an International Electrotechnical Commission standard that defines the architecture of data communication systems used in trains. The structure of the Ethernet data communication system that has been defined in the standard includes Ethernet Train Backbone (ETB) and Ethernet Consist Network (ECN) that relate to IEC 61375-2-3 Electronic Railway Equipment. It also contains information about Train Communication Networks, Communication Profiles, IEC 61375-2-5 Electronic Railway Equipment, Train Communication Networks, and Ethernet Train Backbones.

## **IKE**

Internet Key Exchange (IKE) is a protocol used in computer networks for establishing and managing security associations and cryptographic keys in virtual private networks (VPNs) to ensure secure communication.

## **Link-State Advertisement Packet (LSA)**

LSA packets (Link-State Advertisement) are packets that contain information about a router's links.

## **MTU (Maximum Transmission Unit)**

The MTU (Maximum Transmission Unit) is the maximum size of a packet that can be transmitted over a network. The MTU is important because it affects the performance and efficiency of data transmission on the network.

## **N-to-1 NAT**

N-to-1 NAT maps multiple private IP addresses to one public IP address.

## **NAT Loopback**

NAT loopback allows devices on a private network to access a server or service hosted on the same network using the public IP address of the network.

## **Network Address Translation (NAT)**

NAT (Network Address Translation) is a method of changing an IP address during Ethernet packet transmission, which can also enhance network security. If you want to hide an internal IP address (LAN) from the external network (WAN), NAT can translate the

internal IP address to a specific IP address, or an internal IP address range to one external IP address.

## **Port Address Translation (PAT)**

Port Address Translation (PAT) maps multiple private IP addresses to one public IP address using different port numbers.

## **VRRP Binding**

Virtual Router Redundancy Protocol (VRRP) Binding is a feature that allows the 1-to-1 NAT rule to be bound to a VRRP index. VRRP Binding is only supported in 1-to-1 NAT. If a VRRP index is selected, the 1-to-1 NAT rule is only valid when the system is the master. If no VRRP index is selected, the 1-to-1 NAT rule will be valid regardless of whether the system is the master or backup.

# IEC 61162-460 Supplementary Declaration

## Preface

IEC 61162-460 is an international standard developed by the International Electrotechnical Commission (IEC) that specifies requirements for digital interfaces used in maritime navigation and radiocommunication equipment. It serves as an extension to IEC 61162-450, focusing on enhancing safety and security within Ethernet-based shipboard networks.

The standard outlines requirements and test methods for equipment intended for use in IEC 61162-460 compliant networks. It also provides guidelines for the network's architecture and its interconnections with other networks, including provisions for redundant network configurations to ensure reliability.

By implementing IEC 61162-460, maritime systems can achieve higher safety and security standards, addressing potential external threats and improving overall network integrity. This is particularly important in modern maritime operations, where robust and secure communication networks are essential for safe navigation and effective radiocommunication.

## Explanation

The configuration recommendations required for equipment to comply with IEC-61162-460 can largely refer directly to the [Security Hardening Guide](#) section. This section serves only as supplementary explanation and declaration.

## Supplementary Declaration

When users configure this device, they need to additionally consider the following requirements to determine if they are necessary for the specific site. If they are, the following recommendations can be referenced:

1. It is recommended that the bandwidth allocated to each port on a 460-switch be greater than or equal to the total traffic handled by the switch.
2. When considering the configuration of trusted access, it is recommended that users restrict access to the device to specific IPs originating from the 460-network. Source IPs outside the allowlist (e.g., IPs from uncontrolled networks) will be blocked.
3. When configuring or adjusting Layer 3-7 policies, users can only access the device and configure Layer 3-7 policies through the trusted access allowlist, which specifies source IPs from the 460-network.
4. Arbitrarily replacing or modifying equipment within the 460 network may lead to cybersecurity concerns. It is recommended to first consult with the system integrator or manufacturer to assess potential risks.
5. If filtering based on each physical port is required, it is recommended to configure a VLAN interface with only one port member. Subsequently, apply the relevant rules to this interface through the Layer 3-7 policy.
6. The communication between devices or software defined within the 460-network must be managed through the EDR-G9010/EDR-8010 or by using alternative devices equipped with 460-switch and 460-forwarder functionalities to achieve control.



# IEC 61375-2-3 Communication Identifiers

This is a list of IEC 61375-2-3 communication identifier ComIDs and their descriptions.

| ComID     | Description                                      |
|-----------|--|
| <b>0</b>  | unspecified PDU                                  |
| <b>1</b>  | ETBCTRL telegram                                 |
| <b>2</b>  | CSTINFO notification message                     |
| <b>3</b>  | CSTINFOCTRL notification message                 |
| <b>10</b> | TRDP Echo  |
| <b>31</b> | TRDP - statistics request command                |
| <b>35</b> | TRDP - global statistics data                    |
| <b>36</b> | TRDP - subscription statistics data              |
| <b>37</b> | TRDP - publishing statistics data                |
| <b>38</b> | TRDP - redundancy statistics data                |
| <b>39</b> | TRDP - join statistics data                      |
| <b>40</b> | TRDP- UDP listener statistics data               |
| <b>41</b> | TRDP - TCP listener statistics data              |
| <b>80</b> | Conformance test- control telegram               |
| <b>81</b> | Conformance test - status telegram               |
| <b>82</b> | Conformance test - confirmation request telegram |
| <b>83</b> | Conformance test - confirmation reply telegram   |
| <b>84</b> | Conformance test - opTrnDir request telegram     |
| <b>85</b> | Conformance test - opTrnDir reply telegram       |

| <b>ComID</b> | <b>Description</b>                                     |
|--------------|--|
| <b>86</b>    | Conformance test - echo request telegram               |
| <b>87</b>    | Conformance test - echo reply telegram                 |
| <b>88</b>    | Conformance test - echo notification telegram          |
| <b>100</b>   | TTDB - operational train directory status telegram     |
| <b>101</b>   | TTDB - operational train directory notification        |
| <b>102</b>   | TTDB - train directory information request             |
| <b>103</b>   | TTDB - train directory information reply               |
| <b>104</b>   | TTDB - consist information request                     |
| <b>105</b>   | TTDB - consist information reply                       |
| <b>106</b>   | TTDB - train network directory information request     |
| <b>107</b>   | TTDB - train network directory information reply       |
| <b>108</b>   | TTDB - operational train directory information request |
| <b>109</b>   | TTDB - operational train directory information reply   |
| <b>110</b>   | TTDB - train information complete request              |
| <b>120</b>   | ECSP - control telegram                                |
| <b>121</b>   | ECSP - status telegram                                 |
| <b>122</b>   | ECSP - Confirmation/Correction request                 |
| <b>123</b>   | ECSP - Confirmation/Correction reply                   |
| <b>130</b>   | ETBN - control request                                 |
| <b>131</b>   | ETBN - status reply                                    |
| <b>132</b>   | ETBN - train network directory request                 |
| <b>133</b>   | ETBN - train network directory reply                   |
| <b>140</b>   | TCN-DNS - resolving request telegram (query)           |

| ComID      | Description                        |
|------------|------------------------------------|
| <b>141</b> | TCN-DNS - resolving reply telegram |

# IEC-104 Cause of Transmission List

This is a list of IEC-104 cause of transmission codes and their descriptions.

| Cause        | Description                                 |
|--------------|---|
| <b>0</b>     | not used                                    |
| <b>1</b>     | periodic, cyclic                            |
| <b>2</b>     | background interrogation                    |
| <b>3</b>     | spontaneous                                 |
| <b>4</b>     | initialized                                 |
| <b>5</b>     | interrogation or interrogated               |
| <b>6</b>     | activation                                  |
| <b>7</b>     | confirmation activation                     |
| <b>8</b>     | deactivation                                |
| <b>9</b>     | confirmation deactivation                   |
| <b>10</b>    | termination activation                      |
| <b>11</b>    | feedback, caused by distant command         |
| <b>12</b>    | feedback, caused by local command           |
| <b>13</b>    | data transmission                           |
| <b>14-19</b> | reserved for further compatible definitions |
| <b>20</b>    | interrogated by general interrogation       |
| <b>21</b>    | interrogated by interrogation group 1       |
| <b>22</b>    | interrogated by interrogation group 2       |
| <b>23</b>    | interrogated by interrogation group 3       |
| <b>24</b>    | interrogated by interrogation group 4       |

| Cause | Description                                   |
|-------|---|
| 25    | interrogated by interrogation group 5         |
| 26    | interrogated by interrogation group 6         |
| 27    | interrogated by interrogation group 7         |
| 28    | interrogated by interrogation group 8         |
| 29    | interrogated by interrogation group 9         |
| 30    | interrogated by interrogation group 10        |
| 31    | interrogated by interrogation group 11        |
| 32    | interrogated by interrogation group 12        |
| 33    | interrogated by interrogation group 13        |
| 34    | interrogated by interrogation group 14        |
| 35    | interrogated by interrogation group 15        |
| 36    | interrogated by interrogation group 16        |
| 37    | interrogated by counter general interrogation |
| 38    | interrogated by interrogation counter group 1 |
| 39    | interrogated by interrogation counter group 2 |
| 40    | interrogated by interrogation counter group 3 |
| 41    | interrogated by interrogation counter group 4 |
| 44    | type-Identification unknown                   |
| 45    | cause unknown                                 |
| 46    | ASDU address unknown                          |
| 47    | Information object address unknown            |

# IEC-104 Type Identification List

This is a list of IEC-104 type identification codes and their descriptions.

## Process information in monitor direction

| Type | Description   |
|------|---|
| 1    | Single point information                                  |
| 2    | Single point information with time tag                    |
| 3    | Double point information                                  |
| 4    | Double point information with time tag                    |
| 5    | Step position information                                 |
| 6    | Step position information with time tag                   |
| 7    | Bit string of 32 bit                                      |
| 8    | Bit string of 32 bit with time tag                        |
| 9    | Measured value, normalized value                          |
| 10   | Measured value, normalized value with time tag            |
| 11   | Measured value, scaled value                              |
| 12   | Measured value, scaled value with time tag                |
| 13   | Measured value, short floating-point value                |
| 14   | Measured value, short floating-point value with time tag  |
| 15   | Integrated totals   |
| 16   | Integrated totals with time tag                           |
| 17   | Event of protection equipment with time tag               |
| 18   | Packed start events of protection equipment with time tag |

| Type | Description   |
|------|---|
| 19   | Packed output circuit information of protection equipment with time tag |
| 20   | Packed single-point information with status change detection            |
| 21   | Measured value, normalized value without quality descriptor             |

## Process telegrams with long time tag (7 octets)

| Type | Description  |
|------|--|
| 30   | Single point information with time tag CP56Time2a                                  |
| 31   | Double point information with time tag CP56Time2a                                  |
| 32   | Step position information with time tag CP56Time2a                                 |
| 33   | Bit string of 32 bit with time tag CP56Time2a                                      |
| 34   | Measured value, normalized value with time tag CP56Time2a                          |
| 35   | Measured value, scaled value with time tag CP56Time2a                              |
| 36   | Measured value, short floating-point value with time tag CP56Time2a                |
| 37   | Integrated totals with time tag CP56Time2a   |
| 38   | Event of protection equipment with time tag CP56Time2a                             |
| 39   | Packed start events of protection equipment with time tag CP56time2a               |
| 40   | Packed output circuit information of protection equipment with time tag CP56Time2a |

## Process information in control direction

| Type | Description    |
|------|----------------|
| 45   | Single command |

| Type | Description                                  |
|------|--|
| 46   | Double command                               |
| 47   | Regulating step command                      |
| 48   | Setpoint command, normalized value           |
| 49   | Setpoint command, scaled value               |
| 50   | Setpoint command, short floating-point value |
| 51   | Bit string 32 bit                            |

## Command telegrams with long time tag (7 octets)

| Type | Description   |
|------|---|
| 58   | Single command with time tag CP56Time2a                               |
| 59   | Double command with time tag CP56Time2a                               |
| 60   | Regulating step command with time tag CP56Time2a                      |
| 61   | Setpoint command, normalized value with time tag CP56Time2a           |
| 62   | Setpoint command, scaled value with time tag CP56Time2a               |
| 63   | Setpoint command, short floating-point value with time tag CP56Time2a |
| 64   | Bit string 32 bit with time tag CP56Time2a                            |

## System information in monitor direction

| Type | Description      |
|------|------------------|
| 70   | End of initializ |



## System information in control direction

| Type       | Description                           |
|------------|---------------------------------------|
| <b>100</b> | (General-) Interrogation command      |
| <b>101</b> | Counter interrogation command         |
| <b>102</b> | Read command                          |
| <b>103</b> | Clock synchronization command         |
| <b>104</b> | (IEC 101) Test command                |
| <b>105</b> | Reset process command                 |
| <b>106</b> | (IEC 101) Delay acquisition command   |
| <b>107</b> | Test command with time tag CP56Time2a |

## Parameter in control direction

| Type       | Description   |
|------------|---|
| <b>110</b> | Parameter of measured value, normalized value           |
| <b>111</b> | Parameter of measured value, scaled value               |
| <b>112</b> | Parameter of measured value, short floating-point value |
| <b>113</b> | Parameter activation                                    |

## File transfer

| Type       | Description   |
|------------|---------------|
| <b>120</b> | File ready    |
| <b>121</b> | Section ready |

| Type       | Description  |
|------------|--|
| <b>122</b> | Call directory, select file, call file, call section |
| <b>123</b> | Last section, last segment                           |
| <b>124</b> | Ack file, Ack section                                |
| <b>125</b> | Segment  |
| <b>126</b> | Directory  |
| <b>127</b> | QueryLog – Request archive file                      |

# LED Behavior

This page describes the LED behaviors for different product series.

## Note

Please note that some LEDs are only on models with related features.

## EDF-G1002 Series LED Behavior

| LED           | Color | State                          | Description  |
|---------------|-------|--------------------------------|--|
| <b>PWR1</b>   | Amber | On                             | Power is being supplied to power input PWR1.   |
|               | Off   | Off                            | Power is not being supplied to the power PWR1.   |
| <b>PWR2</b>   | Amber | On                             | Power is being supplied to power input PWR2.   |
|               | Off   | Off                            | Power is not being supplied to the power PWR2.   |
| <b>STATE</b>  | Green | On                             | The system passed the self-diagnosis test during boot-up and is ready to run.            |
|               |       | Blinking (1 Hz)                | The system is ready to do a factory reset after pressing the reset button for 5 seconds. |
|               | Red   | On                             | The system failed the self-diagnosis test during boot-up.                                |
|               | Off   | Off                            | The system is off.   |
| <b>USB</b>    | Green | On                             | A USB device is connected.   |
|               |       | Blinking (1 sec off, 1 sec on) | USB data is being transmitted.   |
|               | Red   | On                             | The USB device is malfunctioning.  |
|               | Off   | Off                            | No USB device connected.   |
| <b>Bypass</b> | Amber | On                             | System-halted bypass or Run-time bypass mode is enabled.                                 |
|               |       | Blinking (0.5 Hz)              | Run-time bypass is enabled and operating   |

| LED                     | Color | State    | Description   |
|-------------------------|-------|----------|---|
|                         | Off   | Off      | System-halted bypass or Run-time bypass mode is disabled.     |
| <b>HA</b>               | Green | On       | Reserved.   |
|                         | Amber | On       | Reserved.   |
|                         | Off   | Off      | Reserved.   |
| <b>10/100/1000 Mbps</b> | Green | On       | The port is active, and a link is established at 1000 Mbps.   |
|                         |       | Blinking | Data is being transmitted at 1000 Mbps.                       |
|                         | Amber | On       | The port is active, and a link is established at 10/100 Mbps. |
|                         |       | Blinking | Data is being transmitted at 10/100 Mbps.                     |
|                         | Off   | Off      | The port is inactive, or the link is down.                    |

## EDR-8010 Series LED Behavior

| LED              | Color | State    | Description   |
|------------------|-------|----------|---|
| <b>PWR1</b>      | Amber | On       | Power is being supplied to power input P1 on the main module.                           |
|                  |       | Off      | Power is not being supplied to power input P1 on the main module.                       |
| <b>PWR2</b>      | Amber | On       | Power is being supplied to power input P2 on the main module.                           |
|                  |       | Off      | Power is not being supplied to power input P2 on the main module.                       |
| <b>STATE</b>     | Green | On       | The system passed the self-diagnosis test on boot-up and is ready to run.               |
|                  |       | Blinking | Device reset is in progress, blinking once per second.                                  |
|                  | Red   | On       | The system failed the self-diagnosis test on boot-up.                                   |
| <b>MSTR/H.TC</b> | Green | On       | The EDR-8010 is set as the Master of the Turbo Ring, or as the Head of the Turbo Chain. |

| LED                | Color | State    | Description   |
|--------------------|-------|----------|---|
|                    |       | Blinking | The Turbo Ring or the Turbo Chain is down.  |
|                    |       | Off      | The EDR-8010 is not set as the Master of this Turbo Ring or is set as a Member of the Turbo Chain.                            |
| <b>CPLR/T.TC</b>   | Green | On       | The EDR-8010 Series' coupling function is enabled to form a backup path, or the device is set as the Tail of the Turbo Chain. |
|                    |       | Blinking | The Turbo Ring or the Turbo Chain is down.  |
|                    |       | Off      | The EDR-8010 Series' coupling function is disabled, or the device is set as a Member of the Turbo Chain.                      |
|                    |       | Green    | On  |
| <b>VRRP/HA</b>     | Green | Off      | The EDR-8010 is not set as the Master of the VRRP or HA.  |
|                    |       | Green    | On  |
| <b>VPN</b>         | Amber | On       | Only parts of the VPN tunnels are working normally.   |
|                    |       | Off      | No active VPN connections.  |
|                    |       | Green    | On  |
| <b>USB</b>         | Green | Blinking | USB data is being transmitted.  |
|                    |       | Red      | On  |
| <b>1G</b>          | Green | On       | 1G SFP link is up.  |
|                    |       | Off      | No link or the SFP link is down.  |
| <b>10/100 Mbps</b> | Green | On       | 10 or 100 Mbps copper link is up.   |
|                    |       | Off      | No link or the copper link is down.   |

## EDR-G9004 Series LED Behavior

| LED            | Color | State    | Description   |   |
|----------------|-------|----------|---|---|
| <b>PWR1</b>    | Amber | On       | Power is being supplied to power input P1 on the main module.             |   |
|                |       | Off      | Power is NOT being supplied to power input P1 on the main module.         |   |
| <b>PWR2</b>    | Amber | On       | Power is being supplied to power input P2 on the main module.             |   |
|                |       | Off      | Power is NOT being supplied to power input P2 on the main module.         |   |
| <b>STATE</b>   | Green | On       | The system passed the self-diagnosis test on boot-up and is ready to run. |   |
|                |       | Blinking | Device reset is in progress, blinking once per second.                    |   |
|                |       | Red      | On  | The system failed the self-diagnosis test on boot-up. |
| <b>BYPASS</b>  | Amber | On       | The bypass redundancy function is enabled.                                |   |
|                |       | Off      | The bypass redundancy function is disabled.                               |   |
| <b>WAN/DMZ</b> | Amber | On       | The WAN2/DMZ port is set to WAN mode.                                     |   |
|                |       | Green    | On  | The WAN2/DMZ port is set to DMZ mode.                 |
|                |       | Off      | The WAN2/DMZ port is disabled.  |   |
| <b>VRRP/HA</b> | Green | On       | The EDR-G9004 is set as the Master of the VRRP or HA.                     |   |
|                |       | Off      | The EDR-G9004 is not set as the Master of the VRRP or HA.                 |   |
| <b>VPN</b>     | Green | On       | All VPN tunnels are working normally.                                     |   |
|                |       | Amber    | On  | Only parts of the VPN tunnels are working normally.   |
|                |       | Off      | No active VPN connections.  |   |
| <b>USB</b>     | Green | On       | USB drive successfully connected.   |   |
|                |       | Blinking | USB data is being transmitted.  |   |
|                |       | Red      | On  | USB dongle malfunction.                               |
| <b>1G/2.5G</b> | Green | On       | 2.5G SFP link is up.  |   |

| LED                          | Color | State | Description                         |
|------------------------------|-------|-------|-------------------------------------|
| <b>10/100/<br/>1000 Mbps</b> | Amber | On    | 1G SFP link is up.                  |
|                              |       | Off   | No link or the SFP link is down.    |
|                              | Green | On    | 1000 Mbps copper link is up.        |
|                              |       | Amber | On                                  |
|                              |       | Off   | No link or the copper link is down. |

## EDR-G9010 Series LED Behavior

| LED              | Color | State    | Description  |
|------------------|-------|----------|--|
| <b>PWR1</b>      | Amber | On       | Power is being supplied to power input P1 on the main module.  |
|                  |       | Off      | Power is not being supplied to power input P1 on the main module.  |
| <b>PWR2</b>      | Amber | On       | Power is being supplied to power input P2 on the main module.  |
|                  |       | Off      | Power is not being supplied to power input P2 on the main module.  |
| <b>STATE</b>     | Green | On       | The system passed the self-diagnosis test on boot-up and is ready to run.  |
|                  |       | Blinking | Device reset is in progress, blinking once per second.   |
|                  | Red   | On       | The system failed the self-diagnosis test on boot-up.  |
| <b>MSTR/H.TC</b> | Green | On       | The EDR-G9010 is set as the Master of the Turbo Ring, or as the Head of the Turbo Chain.                                       |
|                  |       | Blinking | The Turbo Ring or the Turbo Chain is down.   |
|                  |       | Off      | The EDR-G9010 is not set as the Master of this Turbo Ring or is set as a Member of the Turbo Chain.                            |
| <b>CPLR/T.TC</b> | Green | On       | The EDR-G9010 Series' coupling function is enabled to form a backup path, or the device is set as the Tail of the Turbo Chain. |
|                  |       | Blinking | The Turbo Ring or the Turbo Chain is down.   |

| LED                     | Color | State    | Description   |
|-------------------------|-------|----------|---|
|                         |       | Off      | The EDR-G9010 Series' coupling function is disabled, or the device is set as a Member of the Turbo Chain. |
| <b>VRRP/HA</b>          | Green | On       | The EDR-G9010 is set as the Master of the VRRP or HA.   |
|                         |       | Off      | The EDR-G9010 is not set as the Master of the VRRP or HA.   |
| <b>VPN</b>              | Green | On       | All VPN tunnels are working normally.   |
|                         |       | Amber    | Only parts of the VPN tunnels are working normally.   |
|                         |       | Off      | No active VPN connections.  |
| <b>USB</b>              | Green | On       | USB drive successfully connected.   |
|                         |       | Blinking | USB data is being transmitted.  |
|                         |       | Red      | USB dongle malfunction.   |
| <b>1G/2.5G</b>          | Green | On       | 2.5G SFP link is up.  |
|                         |       | Amber    | 1G SFP link is up.  |
|                         |       | Off      | No link or the SFP link is down.  |
| <b>10/100/1000 Mbps</b> | Green | On       | 1000 Mbps copper link is up.  |
|                         |       | Amber    | 10/100 Mbps copper link is up.  |
|                         |       | Off      | No link or the copper link is down.   |



# MIB Groups

Your device comes with integrated SNMP (Simple Network Management Protocol) agent software, compliant with RFC-123 standard MIB and properties MIB. The following is a list of all the folders and related MIB files.

For comprehensive MIB information, you can use MIB browser tools. These tools provide a detailed view of the MIB tree, allowing for easier management and monitoring of network devices. Additionally, the complete MIB files can be downloaded from the product page on the Moxa website. Visit the Moxa product pages to access the latest MIB files and other related resources.

## MIB Tree Structure

The MIB tree structure is designed for all Moxa router series. However, some MIB files may not be supported due to the varying support levels of each product series. Refer to the [Supported Features List](#) for detailed information about supported features.



```

| +---network(3)
| |
| | +---networkSetting(1)
| | |
| | | +---wanSetting(1)
| | | |
| | | | +--- r-n Enumeration    wanConnMode(1)
| | | | +--- r-n Enumeration    wanConnType(2)
| | | | +--- r-n IpAddress      wanStaticIpAddr(3)
| | | | +--- r-n IpAddress      wanStaticIpMask(4)
| | | | +--- r-n IpAddress      wanStaticDefaultGateway(5)
| | | | +--- r-n DisplayString  wanAdslName(6)
| | | | +--- r-n DisplayString  wanAdslHost(7)
| | | | +--- r-n Enumeration    wanPptpEnable(9)
| | | | +--- r-n IpAddress      wanPptpAddr(10)
| | | | +--- r-n DisplayString  wanPptpUserName(11)
| | | | +--- r-n IpAddress      wanDnsServer1(13)
| | | | +--- r-n IpAddress      wanDnsServer2(14)
| | | | +--- r-n IpAddress      wanDnsServer3(15)
| | | | +--- r-n IpAddress      ipAddr(16)
| | | | +--- r-n IpAddress      ipMask(17)
| | | | +--- r-n IpAddress      defaultGateway(18)
| | | | +--- r-n Enumeration    directedBroadcast(19)
| | | | +--- r-n Enumeration    sourceIPOverwrite(20)
| | |
| | | +---wan2Setting(2)
| | | |
| | | | +--- r-n Enumeration    wan2ConnMode(1)
| | | | +--- r-n Enumeration    wan2ConnType(2)
| | | | +--- r-n Enumeration    wan2DmzState(3)
| | | | +--- r-n IpAddress      wan2StaticIpAddr(4)
| | | | +--- r-n IpAddress      wan2StaticIpMask(5)
| | | | +--- r-n IpAddress      wan2StaticDefaultGateway(6)
| | | | +--- r-n DisplayString  wan2AdslName(7)
| | | | +--- r-n DisplayString  wan2AdslHost(8)
| | | | +--- r-n Enumeration    wan2PptpEnable(10)
| | | | +--- r-n IpAddress      wan2PptpAddr(11)
| | | | +--- r-n DisplayString  wan2PptpUserName(12)
| | | | +--- r-n IpAddress      wan2DnsServer1(14)
| | | | +--- r-n IpAddress      wan2DnsServer2(15)
| | | | +--- r-n IpAddress      wan2DnsServer3(16)
| | | | +--- r-n IpAddress      wan2IpAddr(17)
| | | | +--- r-n IpAddress      wan2IpMask(18)
| | | | +--- r-n IpAddress      wan2DefaultGateway(19)
| | | | +--- r-n Enumeration    wan2DirectedBroadcast(20)
| | | | +--- r-n Enumeration    wan2SourceIPOverwrite(21)
| | |
| | | +---lanSetting(3)
| | | |
| | | | +---lanTable(1)
| | | | |
| | | | | +---lanEntry(1) [lanVlanId]
| | | | | |
| | | | | | +--- r-n Integer32    lanVlanId(1)
| | | | | | +--- r-n Enumeration    lanEnable(2)
| | | | | | +--- r-n DisplayString  lanName(3)
| | | | | | +--- r-n IpAddress      lanIpAddr(4)
| | | | | | +--- r-n IpAddress      lanIpMask(5)
| | | | | | +--- r-n Enumeration    lanDirectedBroadcast(6)
| | | | | | +--- r-n Enumeration    lanSourceIPOverwrite(7)
| | | |
| | | | +---dhcpServer(4)
| | | | |
| | | | | +---dhcpSrvTable(1)
| | | | | |
| | | | | | +---dhcpSrvEntry(1) [dhcpSvrEnable]
| | | | | | |
| | | | | | | +--- r-n Enumeration    dhcpSvrEnable(1)
| | | | | | | +--- r-n Integer32    dhcpSvrLeaseTime(2)
| | | | | | | +--- r-n IpAddress      dhcpSvrDns1(3)

```



```

| |         +---guaranlinkSetting(4)
| |         | |
| |         | | +--- rwn Enumeration glinkEnable(1)
| |         | | +--- rwn Enumeration glinkCheckTiming(2)
| |         | |
| |         +---remoteSmsSetting(5)
| |         | |
| |         | | +--- rwn Enumeration remoteSmsEnable(1)
| |         | |
| |         +---gnssSetting(6)
| |         | |
| |         | | +--- rwn Enumeration gnssEnable(1)
| |         | | +--- rwn Enumeration gnssServerEnable(2)
| |         | | +--- rwn Enumeration gnssClientEnable(3)
| |         | | +--- r-n DisplayString gnssSatelliteStatus(4)
| |         | | +--- r-n DisplayString gnssLongitudeStatus(5)
| |         | | +--- r-n DisplayString gnssLatitudeStatus(6)
| |
| | +---routeSetting(5)
| | |
| | | +---showRoutingTable(3)
| | | |
| | | | +---rTable(1)
| | | | |
| | | | | +---rEntry(1) [rIndex]
| | | | | |
| | | | | | +--- rwn DisplayString rType(1)
| | | | | | +--- rwn DisplayString rDestination(2)
| | | | | | +--- rwn IPAddress rNextHop(3)
| | | | | | +--- rwn DisplayString rIifsName(4)
| | | | | | +--- rwn Integer32 rMetric(5)
| | | | | | +--- --- Integer32 rIndex(6)
| | |
| | +---natSetting(6)
| | |
| | | +---natTable(1)
| | | |
| | | | +---natEntry(1) [natIndex]
| | | | |
| | | | | +--- r-n Integer32 natIndex(1)
| | | | | +--- r-n Enumeration natEnable(2)
| | | | | +--- r-n DisplayString natDesc(3)
| | | | | +--- r-n Enumeration natMode(4)
| | | | | +--- r-n Enumeration natProtocolTcp(10)
| | | | | +--- r-n Enumeration natProtocolUdp(11)
| | | | | +--- r-n Enumeration natProtocolIcmp(12)
| | | | | +--- r-n Enumeration natNatLoopback(50)
| | | | | +--- r-n Enumeration natDoubleNat(51)
| | | | | +--- r-n Integer32 natVrrpBinding(52)
| | | | | +--- r-n DisplayString natOriIface(100)
| | | | | +--- r-n IPAddress natOriSrcIp1(110)
| | | | | +--- r-n IPAddress natOriSrcIp2(111)
| | | | | +--- r-n IPAddress natOriSrcMask(112)
| | | | | +--- r-n Integer32 natOriSrcPort1(114)
| | | | | +--- r-n Integer32 natOriSrcPort2(115)
| | | | | +--- r-n IPAddress natOriDstIp1(130)
| | | | | +--- r-n IPAddress natOriDstIp2(131)
| | | | | +--- r-n IPAddress natOriDstMask(132)
| | | | | +--- r-n Integer32 natOriDstPort1(134)
| | | | | +--- r-n Integer32 natOriDstPort2(135)
| | | | | +--- r-n DisplayString natTransIface(150)
| | | | | +--- r-n IPAddress natTransSrcIp1(160)
| | | | | +--- r-n IPAddress natTransSrcIp2(161)
| | | | | +--- r-n IPAddress natTransSrcMask(162)
| | | | | +--- r-n Enumeration natTransSrcDyn(163)
| | | | | +--- r-n Integer32 natTransSrcPort1(164)
| | | | | +--- r-n Integer32 natTransSrcPort2(165)
| | | | | +--- r-n IPAddress natTransDstIp1(180)
| | | | | +--- r-n IPAddress natTransDstIp2(181)
| | | | | +--- r-n IPAddress natTransDstMask(182)

```



```

| | | | +-- r-n Enumeration ipsecExchange (22)
| | | | +-- r-n Enumeration ipsecP1Encrypt (23)
| | | | +-- r-n Enumeration ipsecP1Ah (24)
| | | | +-- r-n Enumeration ipsecP1Dh (25)
| | | | +-- r-n Integer32 ipsecIKELifetime (27)
| | | | +-- r-n Integer32 ipsecSaLifetime (30)
| | | | +-- r-n Enumeration ipsecP2Encrypt (31)
| | | | +-- r-n Enumeration ipsecP2Ah (32)
| | | | +-- r-n Enumeration ipsecDpdAction (33)
| | | | +-- r-n Integer32 ipsecDpdDelay (34)
| | | | +-- r-n Integer32 ipsecDpdTimeout (35)
| | | | +-- r-n Enumeration ipsecIdentityType (36)
| | | | +-- r-n Enumeration ipsecPfsDHGroup (37)
| | | | +-- r-n DisplayString ipsecLocalSubnet (38)
| | | | +-- r-n DisplayString ipsecRemoteSubnet (39)
| | | |
| | | | +--ipsecStatus (3)
| | | | |
| | | | | +--ipsecStatusTable (1)
| | | | | |
| | | | | | +--ipsecStatusEntry (1) [ipsecStatusIndex]
| | | | | | |
| | | | | | | +-- r-n DisplayString ipsecStatusName (1)
| | | | | | | +-- r-n DisplayString ipsecStatusLocSubnet (2)
| | | | | | | +-- r-n IpAddress ipsecStatusLocGateway (3)
| | | | | | | +-- r-n IpAddress ipsecStatusRemGateway (4)
| | | | | | | +-- r-n DisplayString ipsecStatusRemSubnet (5)
| | | | | | | +-- r-n DisplayString ipsecStatusPhase1 (6)
| | | | | | | +-- r-n DisplayString ipsecStatusPhase2 (7)
| | | | | | | +-- r-n Enumeration ipsecL2tp (8)
| | | | | | | +-- --- Integer32 ipsecStatusIndex (9)
| | | | |
| | | | +--vpnL2tp (2)
| | | | |
| | | | | +-- r-n Enumeration l2tpModeWan1 (1)
| | | | | +-- r-n IpAddress l2tpLocalIpWan1 (2)
| | | | | +-- r-n IpAddress l2tpOfferIpStartWan1 (3)
| | | | | +-- r-n IpAddress l2tpOfferIpEndWan1 (4)
| | | | |
| | | | | +--l2tpTable (9)
| | | | | |
| | | | | | +--l2tpEntry (1) [l2tpLoginUserName]
| | | | | | |
| | | | | | | +-- r-n DisplayString l2tpLoginUserName (1)
| | | |
| | | +--snmpSetting (9)
| | | |
| | | | +--snmpSetup (1)
| | | | |
| | | | | +-- r-n Enumeration snmpVersion (1)
| | | | | +-- rwn Enumeration snmpAuthType (3)
| | | | | +-- rwn Integer32 snmpAccessControl1 (7)
| | | | | +-- rwn Integer32 snmpAccessControl2 (9)
| | | | | +-- rwn DisplayString trap1ServerAddr (10)
| | | | | +-- rwn DisplayString trap2ServerAddr (11)
| | | | | +-- rwn DisplayString trap3ServerAddr (12)
| | | | | +-- rwn Enumeration snmpInformEnable (13)
| | | | | +-- rwn DisplayString snmpReadCommunity1 (14)
| | | | | +-- rwn DisplayString snmpReadCommunity2 (15)
| | | | | +-- rwn DisplayString snmpTrapCommunity (16)
| | | | | +-- rwn Enumeration snmpTrapMode (17)
| | | | | +-- r-n Enumeration snmpAdminSecurityLevel (22)
| | | | | +-- r-n Enumeration snmpUserSecurityLevel (23)
| | | |
| | | +--diagnosisSetting (12)
| | | |
| | | | +--lldpSetting (2)
| | | | |
| | | | | +-- rwn Enumeration lldpEnable (1)
| | | | | +-- rwn Integer32 lldpInterval (2)

```

```

| | +-- rwn Enumeration lldpRingPortBypass(3)
| |
| | +---monitor(13)
| | |
| | | +-- r-n Enumeration power1InputStatus(7)
| | | +-- r-n Enumeration power2InputStatus(8)
| | | |
| | | +---monitorFiberCheckTable(11)
| | | |
| | | | +---monitorFiberCheckEntry(1) [portIndex]
| | | | |
| | | | | +-- r-n DisplayString fiberPort(1)
| | | | | +-- r-n DisplayString fiberModelName(2)
| | | | | +-- r-n DisplayString fiberWaveLength(3)
| | | | | +-- r-n DisplayString fiberVoltage(4)
| | | | | +-- r-n DisplayString fiberTemperature(5)
| | | | | +-- r-n DisplayString fiberTempWarn(6)
| | | | | +-- r-n DisplayString fiberTxPower(7)
| | | | | +-- r-n DisplayString fiberTxPowerWarn(8)
| | | | | +-- r-n DisplayString fiberRxPower(9)
| | | | | +-- r-n DisplayString fiberRxPowerWarn(10)
| | | | | +-- r-n DisplayString fiberSN(13)
| | | |
| | | +---systemLog(14)
| | | |
| | | | +---syslog(2)
| | | | |
| | | | | +-- r-n Enumeration syslogServer1Enable(1)
| | | | | +-- r-n DisplayString syslogServer1(2)
| | | | | +-- r-n Integer32 syslogServer1Port(3)
| | | | | +-- r-n Enumeration syslogServer2Enable(4)
| | | | | +-- r-n DisplayString syslogServer2(5)
| | | | | +-- r-n Integer32 syslogServer2Port(6)
| | | | | +-- r-n Enumeration syslogServer3Enable(7)
| | | | | +-- r-n DisplayString syslogServer3(8)
| | | | | +-- r-n Integer32 syslogServer3Port(9)
| | | | | +-- r-n DisplayString syslogServer1Cert(10)
| | | | | +-- r-n DisplayString syslogServer2Cert(11)
| | | | | +-- r-n DisplayString syslogServer3Cert(12)
| | | | | +-- r-n Enumeration syslogServer1MsgFormat(13)
| | | | | +-- r-n Enumeration syslogServer2MsgFormat(14)
| | | | | +-- r-n Enumeration syslogServer3MsgFormat(15)
| | | |
| | | +---networkMode(15)
| | | |
| | | | +-- r-n Enumeration networkModeSelection(1)
| | | |
| | | +---routingRedundancy(16)
| | | |
| | | | +---vrrp(1)
| | | | |
| | | | | +---vrrpInterfaceTable(1)
| | | | | |
| | | | | | +---vrrpInterfaceEntry(1) [vrrpIfIndex]
| | | | | | |
| | | | | | | +-- rwn DisplayString vrrpIfName(1)
| | | | | | | +-- r-n IPAddress vrrpIfAddr(2)
| | | | | | | +-- rwn Enumeration vrrpIfEnable(3)
| | | | | | | +-- rwn IPAddress vrrpIfVirtualIp(4)
| | | | | | | +-- rwn Integer32 vrrpIfRouterId(5)
| | | | | | | +-- rwn Integer32 vrrpIfPriority(6)
| | | | | | | +-- rwn Enumeration vrrpIfPreemption(7)
| | | | | | | +-- r-n Enumeration vrrpIfStatus(8)
| | | | | | | +-- rwn DisplayString vrrpIfTrack(9)
| | | | | | | +-- rwn IPAddress vrrpPingTrackIP(10)
| | | | | | | +-- rwn Integer32 vrrpPingTrackInt(11)
| | | | | | | +-- rwn Integer32 vrrpPingTimeout(12)
| | | | | | | +-- rwn Integer32 vrrpPingTrackSuccess(13)
| | | | | | | +-- rwn Integer32 vrrpPingTrackFailure(14)
| | | | | | | +-- rwn Integer32 vrrpAdvInt(15)

```



```

| | | | +-- rwn Integer32      vrrpPreemptDelay(16)
| | | | +-- --- Integer32     vrrpIfIndex(17)
| | | | |
| | | | +-- rwn Enumeration vrrpEnable(2)
| | | | |
| | | | +---portSetting(17)
| | | | |
| | | | | +---portTable(1)
| | | | | |
| | | | | | +---portEntry(1) [portIndex]
| | | | | | |
| | | | | | | +-- r-n DisplayString portDesc(1)
| | | | | | | +-- rwn Enumeration portEnable(2)
| | | | | | | +-- r-n Enumeration portSpeed(3)
| | | | | | | +-- r-n Enumeration portMDI(4)
| | | | | | | +-- r-n Enumeration portFDXFlowCtrl(5)
| | | | | | | +-- rwn DisplayString portName(6)
| | | | | | | +-- r-n Enumeration portType(7)
| | | | | | | +-- r-n Integer32 portIndex(8)
| | | | | |
| | | | | +---portTrunking(19)
| | | | | |
| | | | | | +---trunkSettingTable(1)
| | | | | | |
| | | | | | | +---trunkSettingEntry(1) [trunkSettingIndex]
| | | | | | | |
| | | | | | | | +-- r-n Integer32 trunkSettingIndex(1)
| | | | | | | | +-- r-n Enumeration trunkType(2)
| | | | | | | | +-- r-n PortList trunkMemberPorts(3)
| | | | | | |
| | | | | | +---trunkTable(2)
| | | | | | |
| | | | | | | +---trunkEntry(1) [trunkIndex, trunkPort]
| | | | | | | |
| | | | | | | | +-- r-n Integer32 trunkIndex(1)
| | | | | | | | +-- r-n Integer32 trunkPort(2)
| | | | | | | | +-- r-n Enumeration trunkStatus(3)
| | | | | |
| | | | | +---commRedundancy(20)
| | | | | |
| | | | | | +---spanningTree(3)
| | | | | | |
| | | | | | | +-- r-n Enumeration spanningTreeRoot(1)
| | | | | | | +-- r-n Enumeration spanningTreeBridgePriority(2)
| | | | | | | +-- r-n Integer32 spanningTreeHelloTime(3)
| | | | | | | +-- r-n Integer32 spanningTreeMaxAge(4)
| | | | | | | +-- r-n Integer32 spanningTreeForwardingDelay(5)
| | | | | | |
| | | | | | | +---spanningTreeTable(6)
| | | | | | | |
| | | | | | | | +---spanningTreeEntry(1) [enableSpanningTree]
| | | | | | | | |
| | | | | | | | | +-- r-n Enumeration enableSpanningTree(2)
| | | | | | | | | +-- r-n Enumeration spanningTreePortPriority(3)
| | | | | | | | | +-- r-n Integer32 spanningTreePortCost(4)
| | | | | | | | | +-- r-n Enumeration spanningTreePortStatus(5)
| | | | | | | | | +-- r-n Enumeration spanningTreePortEdge(6)
| | | | | | |
| | | | | | +-- r-n Enumeration activeProtocolOfRedundancy(4)
| | | | | |
| | | | | +---turboRingV2(5)
| | | | | |
| | | | | | +---turboRingV2Ring1(1)
| | | | | | |
| | | | | | | +-- r-n Integer32 ringIndexRing1(1)
| | | | | | | +-- r-n Enumeration ringEnableRing1(2)
| | | | | | | +-- r-n Enumeration masterSetupRing1(3)
| | | | | | | +-- r-n Enumeration masterStatusRing1(4)
| | | | | | | +-- r-n MacAddress designatedMasterRing1(5)
| | | | | | | +-- r-n Integer32 rdnt1stPortRing1(6)

```

```

| | | | +-- r-n Enumeration rdnt1stPortStatusRing1 (7)
| | | | +-- r-n Integer32 rdnt2ndPortRing1 (8)
| | | | +-- r-n Enumeration rdnt2ndPortStatusRing1 (9)
| | | | +-- r-n Enumeration brokenStatusRing1 (10)
| | | |
| | | +--turboRingV2Ring2 (2)
| | | |
| | | | +-- r-n Integer32 ringIndexRing2 (1)
| | | | +-- r-n Enumeration ringEnableRing2 (2)
| | | | +-- r-n Enumeration masterSetupRing2 (3)
| | | | +-- r-n Enumeration masterStatusRing2 (4)
| | | | +-- r-n MacAddress designatedMasterRing2 (5)
| | | | +-- r-n Integer32 rdnt1stPortRing2 (6)
| | | | +-- r-n Enumeration rdnt1stPortStatusRing2 (7)
| | | | +-- r-n Integer32 rdnt2ndPortRing2 (8)
| | | | +-- r-n Enumeration rdnt2ndPortStatusRing2 (9)
| | | | +-- r-n Enumeration brokenStatusRing2 (10)
| | | |
| | | +--turboRingV2Coupling (3)
| | | |
| | | | +-- r-n Enumeration couplingEnable (1)
| | | | +-- r-n Enumeration couplingMode (2)
| | | | +-- r-n Integer32 coupling1stPort (3)
| | | | +-- r-n Enumeration coupling1stPortStatus (4)
| | | | +-- r-n Integer32 coupling2ndPort (5)
| | | | +-- r-n Enumeration coupling2ndPortStatus (6)
| | | |
| | | +--turboChain (6)
| | | |
| | | | +-- rwn Enumeration turboChainRole (1)
| | | | +-- rwn Integer32 turboChainPort1 (2)
| | | | +-- rwn Integer32 turboChainPort2 (3)
| | | | +-- r-n Enumeration turboChainPort1Status (4)
| | | | +-- r-n Enumeration turboChainPort2Status (5)
| | | |
| | | +--vlan (21)
| | | |
| | | | +--vlanPortSettingTable (1)
| | | | |
| | | | | +--vlanPortSettingEntry (1) [portIndex]
| | | | | |
| | | | | | +-- r-n Enumeration portVlanType (1)
| | | | | | +-- r-n Integer32 portDefaultVid (2)
| | | | | | +-- r-n DisplayString portFixedVid (3)
| | | | | | +-- r-n DisplayString portFixedVidUntag (5)
| | | | |
| | | | +--vlanTable (2)
| | | | |
| | | | | +--vlanEntry (1) [vlanId]
| | | | | |
| | | | | | +-- r-n Integer32 vlanId (1)
| | | | | | +-- r-n PortList joinedAccessPorts (2)
| | | | | | +-- r-n PortList joinedTrunkPorts (3)
| | | | | | +-- r-n PortList joinedHybirdPorts (4)
| | | | |
| | | | | +-- r-n Integer32 managementVlanId (3)
| | | | | +-- r-n Enumeration vlanType (4)
| | | | |
| | | | +--swMgmtGroup (22)
| | | | |
| | | | | +-- r-n Integer32 numberOfPorts (1)
| | | | | +-- r-n DisplayString switchModel (2)
| | | | | +-- r-n DisplayString firmwareVersion (4)
| | | | |
| | | | +--globalStatus (23)
| | | | |
| | | | | +-- r-n Enumeration firewallGlobalStatus (1)
| | | | | +-- r-n Enumeration natGlobalStatus (2)
| | | | | +-- r-n Enumeration vpnGlobalStatus (3)
| | | | | +-- r-n Enumeration securityNotificationFirewallStatus (4)

```

```

| | +-- r-n Enumeration securityNotificationDoSAttackStatus (5)
| | +-- r-n Enumeration securityNotificationAccessViolationStatus (6)
| | +-- r-n Enumeration securityNotificationLoginFailStatus (7)
| | +-- r-n Enumeration defaultPasswordChange (8)
| | +-- r-n Enumeration securityNotificationDeviceLockdownStatus (9)
| | +-- r-n Enumeration securityNotificationLayer3FilterStatus (10)
| |
| +--interfaceStatus (24)
| | |
| | +--interfaceStatusTable (1)
| | | |
| | | +--interfaceStatusEntry (1) [interfaceOverallStatus]
| | | | |
| | | | +-- r-n DisplayString interfaceOverallStatus (1)
| | | | +-- r-n Enumeration interfaceOverallType (2)
| | | |
| | +--cellularStatus (2)
| | |
| | | +-- r-n DisplayString cellularMode (1)
| | | +-- r-n DisplayString cellularCarrier (2)
| | | +-- r-n DisplayString cellularRSSI (3)
| | | +-- r-n DisplayString cellularIP (4)
| | | +-- r-n DisplayString cellularIMEI (5)
| | | +-- r-n DisplayString cellularIMSI (6)
| | | +-- r-n Enumeration cellularConnectionStatus (7)
| | | +-- r-n DisplayString cellularSim1Status (8)
| | | +-- r-n DisplayString cellularSim2Status (9)
| | | +-- r-n DisplayString cellularRSRP (10)
| | | +-- r-n DisplayString cellularRSRQ (11)
| | | +-- r-n DisplayString cellularSINR (12)
| | |
| +--securityNotification (25)
| | |
| | | +-- r-n Enumeration eventFirewall (1)
| | | +-- r-n Enumeration eventDoSAttack (2)
| | | +-- r-n Enumeration eventAccessViolation (3)
| | | +-- r-n Enumeration eventLoginFail (4)
| | | +-- r-n Enumeration eventDeviceLockdown (5)
| | | +-- r-n Enumeration eventLayer3Filter (6)
| | |
| +--mtuAdjustment (28)
| | |
| | | +--mtuAdjustmentTable (1)
| | | |
| | | | +--mtuAdjustmentEntry (1) [mtuAdjustmentIndex]
| | | | |
| | | | | +-- r-n DisplayString mtuAdjustmentIfName (1)
| | | | | +-- rwn Integer32 mtuAdjustmentMTUsize (2)
| | | | | +-- rwn Enumeration mtuAdjustmentPRPtraffic (3)
| | | | | +-- --- Integer32 mtuAdjustmentIndex (4)
| | | |
| +--poeSetting (40)
| | |
| | | +--poePortTable (3)
| | | |
| | | | +--poePortEntry (1) [poePortIndex]
| | | | |
| | | | | +-- r-n Integer32 poePortIndex (1)
| | | | | +-- rwn Enumeration poePortEnable (2)
| | | | | +-- rwn Integer32 powerLimit (4)
| | | | | +-- rwn Enumeration pdfailure (5)
| | | | | +-- rwn DisplayString pdipaddr (6)
| | | | | +-- rwn Integer32 pdPollingInterval (7)
| | | | | +-- rwn Enumeration poePortLegacyPdDetect (9)
| | | | | +-- rwn Integer32 pdNoResponseTimeout (10)
| | | | | +-- rwn Enumeration pdNoResponseAction (11)
| | | | | +-- rwn Enumeration poePowerOutputMode (12)
| | | |
| | +--poeStatusTable (6)
| | |

```

```

| | | +---poeStatusEntry(1) [poePortIndex]
| | | |
| | | | +--- r-n Enumeration poePortStatus(1)
| | | | +--- r-n Enumeration poePortConsumption(2)
| | | | +--- r-n Enumeration poePortVoltage(3)
| | | | +--- r-n Enumeration poePortCurrent(4)
| | | | +--- r-n Enumeration poePortPowerOutput(5)
| | | | +--- r-n Enumeration poePortClass(6)
| | | | +--- r-n Enumeration poePortPdFailCheck(7)
| | | | +--- r-n Enumeration poePortPdStatusDescription(8)
| | |
| | | +---poeSystemSetting(9)
| | | |
| | | | +--- rwn Enumeration poeSysPowerEnable(1)
| | | | +--- rwn Integer32 poeSysPowerThreshold(2)
| | | | +--- rwn Enumeration poeSysThresholdCutOff(3)
| | | | +--- r-n Integer32 poeSysAllocatedPower(4)
| | | | +--- r-n Integer32 poeSysMeasuredPower(5)
| | | | +--- rwn Integer32 poeSysPowerBudget(7)
| | |
| | | +---eventlog(46)
| | | |
| | | | +---eventlogSystem(1)
| | | | |
| | | | | +---eventlogSystemTable(1)
| | | | | |
| | | | | | +---eventlogSystemEntry(1) [eventlogSystemIndex]
| | | | | | |
| | | | | | | +--- r-n Integer32 eventlogSystemIndex(1)
| | | | | | | +--- r-n DisplayString eventlogSystemTimestamp(2)
| | | | | | | +--- r-n Integer32 eventlogSystemSeverity(3)
| | | | | | | +--- r-n DisplayString eventlogSystemEvent(4)
| | | | | |
| | | | | | +--- rwn Enumeration eventlogSystemClear(2)
| | | |
| | | | +---eventlogVPN(2)
| | | | |
| | | | | +---eventlogVPNTable(1)
| | | | | |
| | | | | | +---eventlogVPNEntry(1) [eventlogVPNIndex]
| | | | | | |
| | | | | | | +--- r-n Integer32 eventlogVPNIndex(1)
| | | | | | | +--- r-n DisplayString eventlogVPNTimestamp(2)
| | | | | | | +--- r-n Integer32 eventlogVPNSeverity(3)
| | | | | | | +--- r-n DisplayString eventlogVPNEvent(4)
| | | | | |
| | | | | | +--- rwn Enumeration eventlogVPNClear(2)
| | | |
| | | | +---eventlogTruseAccess(3)
| | | | |
| | | | | +---eventlogTruseAccessTable(1)
| | | | | |
| | | | | | +---eventlogTruseAccessEntry(1) [eventlogTruseAccessIndex]
| | | | | | |
| | | | | | | +--- r-n Integer32 eventlogTruseAccessIndex(1)
| | | | | | | +--- r-n DisplayString eventlogTruseAccessTimestamp(2)
| | | | | | | +--- r-n Integer32 eventlogTruseAccessSeverity(3)
| | | | | | | +--- r-n DisplayString eventlogTruseAccessEvent(4)
| | | | | |
| | | | | | +--- rwn Enumeration eventlogTruseAccessClear(2)
| | | |
| | | | +---eventlogMalformed(4)
| | | | |
| | | | | +---eventlogMalformedTable(1)
| | | | | |
| | | | | | +---eventlogMalformedEntry(1) [eventlogMalformedIndex]
| | | | | | |
| | | | | | | +--- r-n Integer32 eventlogMalformedIndex(1)
| | | | | | | +--- r-n DisplayString eventlogMalformedTimestamp(2)
| | | | | | | +--- r-n Integer32 eventlogMalformedSeverity(3)

```

```

| | | | +-- r-n DisplayString eventlogMalformedEvent (4)
| | | | +-- rwn Enumeration eventlogMalformedClear (2)
| | | | +--eventlogDOS (5)
| | | | | +--eventlogDOSTable (1)
| | | | | | +--eventlogDOSEntry (1) [eventlogDOSIndex]
| | | | | | | +-- r-n Integer32 eventlogDOSIndex (1)
| | | | | | | +-- r-n DisplayString eventlogDOSTimestamp (2)
| | | | | | | +-- r-n Integer32 eventlogDOSSeverity (3)
| | | | | | | +-- r-n DisplayString eventlogDOSEvent (4)
| | | | | | +-- rwn Enumeration eventlogDOSClear (2)
| | | | +--eventlogDevLockdown (6)
| | | | | +--eventlogDevLockdownTable (1)
| | | | | | +--eventlogDevLockdownEntry (1) [eventlogDevLockdownIndex]
| | | | | | | +-- r-n Integer32 eventlogDevLockdownIndex (1)
| | | | | | | +-- r-n DisplayString eventlogDevLockdownTimestamp (2)
| | | | | | | +-- r-n Integer32 eventlogDevLockdownSeverity (3)
| | | | | | | +-- r-n DisplayString eventlogDevLockdownEvent (4)
| | | | | | +-- rwn Enumeration eventlogDevLockdownClear (2)
| | | | +--eventlogL3Policy (7)
| | | | | +--eventlogL3PolicyTable (1)
| | | | | | +--eventlogL3PolicyEntry (1) [eventlogL3PolicyIndex]
| | | | | | | +-- r-n Integer32 eventlogL3PolicyIndex (1)
| | | | | | | +-- r-n DisplayString eventlogL3PolicyTimestamp (2)
| | | | | | | +-- r-n Integer32 eventlogL3PolicySeverity (3)
| | | | | | | +-- r-n DisplayString eventlogL3PolicyEvent (4)
| | | | | | +-- rwn Enumeration eventlogL3PolicyClear (2)
| | | | +--eventlogProtocolFilterPolicy (8)
| | | | | +--eventlogProtocolFilterPolicyTable (1)
| | | | | | +--eventlogProtocolFilterPolicyEntry (1)
| | | | | | | [eventlogProtocolFilterPolicyIndex]
| | | | | | | | +-- r-n Integer32 eventlogProtocolFilterPolicyIndex (1)
| | | | | | | | +-- r-n DisplayString eventlogProtocolFilterPolicyTimestamp (2)
| | | | | | | | +-- r-n Integer32 eventlogProtocolFilterPolicySeverity (3)
| | | | | | | | +-- r-n DisplayString eventlogProtocolFilterPolicyEvent (4)
| | | | | | +-- rwn Enumeration eventlogProtocolFilterPolicyClear (2)
| | | | +--eventlogADP (9)
| | | | | +--eventlogADPTable (1)
| | | | | | +--eventlogADPEntry (1) [eventlogADPIndex]
| | | | | | | +-- r-n Integer32 eventlogADPIndex (1)
| | | | | | | +-- r-n DisplayString eventlogADPTimestamp (2)
| | | | | | | +-- r-n Integer32 eventlogADPSeverity (3)
| | | | | | | +-- r-n DisplayString eventlogADPEvent (4)
| | | | | | +-- rwn Enumeration eventlogADPClear (2)

```

```

| | +--eventlogIPS (10)
| | |
| | | +--eventlogIPSTable (1)
| | | |
| | | | +--eventlogIPSEntry (1) [eventlogIPSIndex]
| | | | |
| | | | | +-- r-n Integer32 eventlogIPSIndex (1)
| | | | | +-- r-n DisplayString eventlogIPSTimestamp (2)
| | | | | +-- r-n Integer32 eventlogIPSSeverity (3)
| | | | | +-- r-n DisplayString eventlogIPSEvent (4)
| | | |
| | | | +-- rwn Enumeration eventlogIPSClear (2)
| | |
| | +--eventlogSessionControl (11)
| | |
| | | +--eventlogSessionControlTable (1)
| | | |
| | | | +--eventlogSessionControlEntry (1) [eventlogSessionControlIndex]
| | | | |
| | | | | +-- r-n Integer32 eventlogSessionControlIndex (1)
| | | | | +-- r-n DisplayString eventlogSessionControlTimestamp (2)
| | | | | +-- r-n Integer32 eventlogSessionControlSeverity (3)
| | | | | +-- r-n DisplayString eventlogSessionControlEvent (4)
| | | |
| | | | +-- rwn Enumeration eventlogSessionControlClear (2)
| | |
| | +--eventlogL2Filter (12)
| | |
| | | +--eventlogL2FilterTable (1)
| | | |
| | | | +--eventlogL2FilterEntry (1) [eventlogL2FilterIndex]
| | | | |
| | | | | +-- r-n Integer32 eventlogL2FilterIndex (1)
| | | | | +-- r-n DisplayString eventlogL2FilterTimestamp (2)
| | | | | +-- r-n Integer32 eventlogL2FilterSeverity (3)
| | | | | +-- r-n DisplayString eventlogL2FilterEvent (4)
| | | |
| | | | +-- rwn Enumeration eventlogL2FilterClear (2)
| | |
| | +--eventlogPingResponse (15)
| | |
| | | +--eventlogPingResponseTable (1)
| | | |
| | | | +--eventlogPingResponseEntry (1) [eventlogPingResponseIndex]
| | | | |
| | | | | +-- r-n Integer32 eventlogPingResponseIndex (1)
| | | | | +-- r-n DisplayString eventlogPingResponseTimestamp (2)
| | | | | +-- r-n Integer32 eventlogPingResponseSeverity (3)
| | | | | +-- r-n DisplayString eventlogPingResponseEvent (4)
| | | |
| | | | +-- rwn Enumeration eventlogPingResponseClear (2)
| | |
| | +-- r-n Integer32 cpuLoading5s (53)
| | +-- r-n Integer32 cpuLoading30s (54)
| | +-- r-n Integer32 cpuLoading300s (55)
| | +-- r-n Integer32 totalMemory (56)
| | +-- r-n Integer32 freeMemory (57)
| | +-- r-n Integer32 usedMemory (58)
| | +-- r-n Integer32 memoryUsage (59)
| | |
| | +--managementInterface (63)
| | |
| | | +-- rwn Enumeration httpEnable (1)
| | | +-- rwn Integer32 httpPort (2)
| | | +-- rwn Enumeration sslEnable (3)
| | | +-- rwn Integer32 sslPort (4)
| | | +-- rwn Enumeration telnetEnable (5)
| | | +-- rwn Integer32 telnetPort (6)
| | | +-- rwn Enumeration sshEnable (7)
| | | +-- rwn Integer32 sshPort (8)

```

```

| | +-- rwn Integer32      mgmtInterfaceAutoLogout (9)
| | +-- r-n DisplayString moxaUtilityServicePort (13)
| | +-- rwn Integer32      httpMaxLoginUsers (14)
| | +-- rwn Integer32      telnetMaxLoginUsers (15)
| | +-- rwn Enumeration    moxaUtilityServiceEnable (16)
| |
| | +--pingResponse (64)
| | |
| | | +--pingResponsePolicyTable (1)
| | | |
| | | | +--pingResponsePolicyEntry (1) [pingResponsePolicyIndex]
| | | | |
| | | | | +-- r-n Integer32      pingResponsePolicyIndex (1)
| | | | | +-- r-n Enumeration    pingResponsePolicyExist (2)
| | | | | +-- r-n Enumeration    pingResponsePolicyEnable (3)
| | | | | +-- r-n DisplayString pingResponsePolicyIf (4)
| | | | | +-- r-n Enumeration    pingResponsePolicyIpType (5)
| | | | | +-- r-n IPAddress      pingResponsePolicyIp (6)
| | | | | +-- r-n IPAddress      pingResponsePolicyMask (7)
| | | | | +-- r-n Enumeration    pingResponsePolicyAction (8)
| | | |
| | | | +-- rwn Enumeration    pingResponseIfEnable (2)
| | | |
| | | | +--pingResponseIfTable (3)
| | | | |
| | | | | +--pingResponseIfEntry (1) [pingResponseIf]
| | | | | |
| | | | | | +-- rwn DisplayString pingResponseIf (1)
| | | | |
| | | | | +-- rwn Enumeration    pingResponslLogEnable (4)
| | | | | +-- rwn Enumeration    pingResponslLogLevel (5)
| | | | | +-- rwn Enumeration    pingResponslLogFlash (6)
| | | | | +-- rwn Enumeration    pingResponslLogSyslog (7)
| | | | | +-- rwn Enumeration    pingResponslLogTrap (8)
| | | |
| | | +--passwordPolicy (70)
| | | |
| | | | +-- rwn Integer32      pwdMinLength (1)
| | | | +-- rwn Enumeration    pwdComplexityCheckEnable (2)
| | | | +-- rwn Enumeration    pwdComplexityCheckDigitEnable (3)
| | | | +-- rwn Enumeration    pwdComplexityCheckAlphabetEnable (4)
| | | | +-- rwn Enumeration    pwdComplexityCheckSpecialCharEnable (5)
| | | |
| | | +--loginLockout (71)
| | | |
| | | | +-- rwn Enumeration    loginFailureLockoutEnable (1)
| | | | +-- rwn Integer32      loginFailureLockoutRetrys (2)
| | | | +-- rwn Integer32      loginFailureLockoutTime (3)
| | | |
| | | +--systemNotifyMessage (72)
| | | |
| | | | +-- r-n DisplayString httpLoginMessage (1)
| | | | +-- r-n DisplayString httpLoginFailureMessage (2)
| | | |
| | | +-- r-n DisplayString serialNumber (78)
| | | +-- r-n Enumeration    configEncryptEnable (79)
| | |
| | +--security (80)
| | |
| | | +--portAccessControl (2)
| | | |
| | | | +--dot1x (2)
| | | | |
| | | | | +-- rwn Enumeration    dataBaseOption (1)
| | | | | +-- rwn Enumeration    dot1xReauthEnable (5)
| | | | | +-- rwn Integer32      dot1xReauthPeriod (6)
| | | | |
| | | | | +--dot1xSettingTable (7)
| | | | | |
| | | | | | +--dot1xSettingEntry (1) [portIndex]

```





```
|  
+--loggingCapacityTrap(52) [varLoggingCapacityTrap]
```

# MMS Command Type List

This is a list of MMS command type codes and command names.

| Command Type | Command Name          |
|--------------|-----------------------|
| 1            | confirmed_RequestPDU  |
| 2            | confirmed_ResponsePDU |
| 3            | confirmed_ErrorPDU    |
| 4            | unconfirmed_PDU       |
| 5            | rejectPDU             |
| 6            | cancel_RequestPDU     |
| 7            | cancel_ResponsePDU    |
| 8            | cancel_ErrorPDU       |
| 9            | initiate_RequestPDU   |
| 10           | initiate_ResponsePDU  |
| 11           | initiate_ErrorPDU     |
| 12           | conclude_RequestPDU   |
| 13           | conclude_ResponsePDU  |
| 14           | conclude_ErrorPDU     |

# MMS Service Operation List

This is a list of MMS service operation codes and their names.

| Service Operation | Service Operation Name        |
|-------------------|-------------------------------|
| 1                 | acknowledgeEventNotification  |
| 2                 | alterEventConditionMonitoring |
| 3                 | alterEventEnrollment          |
| 4                 | createJournal                 |
| 5                 | createProgramInvocation       |
| 6                 | defineEventAction             |
| 7                 | defineEventCondition          |
| 8                 | defineEventEnrollment         |
| 9                 | defineNamedType               |
| 10                | defineNamedVariable           |
| 11                | defineNamedVariableList       |
| 12                | defineScatteredAccess         |
| 13                | defineSemaphore               |
| 14                | deleteDomain                  |
| 15                | deleteEventAction             |
| 16                | deleteEventCondition          |
| 17                | deleteEventEnrollment         |
| 18                | deleteJournal                 |
| 19                | deleteNamedType               |
| 20                | deleteNamedVariableList       |

| Service Operation | Service Operation Name         |
|-------------------|--------------------------------|
| 21                | deleteProgramInvocation        |
| 22                | deleteSemaphore                |
| 23                | deleteVariableAccess           |
| 24                | downloadSegment                |
| 25                | eventNotification              |
| 26                | fileClose                      |
| 27                | fileDelete                     |
| 28                | fileDirectory                  |
| 29                | fileOpen                       |
| 30                | fileRead                       |
| 31                | fileRename                     |
| 32                | getAlarmEnrollmentSummary      |
| 33                | getAlarmSummary                |
| 34                | getCapabilityList              |
| 35                | getDomainAttributes            |
| 36                | getEventActionAttributes       |
| 37                | getEventConditionAttributes    |
| 38                | getEventEnrollmentAttributes   |
| 39                | getNamedTypeAttributes         |
| 40                | getNamedVariableListAttributes |
| 41                | getNameList                    |
| 42                | getProgramInvocationAttributes |
| 43                | getScatteredAccessAttributes   |

| Service Operation | Service Operation Name      |
|-------------------|-----------------------------|
| 44                | getVariableAccessAttributes |
| 45                | identify                    |
| 46                | informationReport           |
| 47                | initializeJournal           |
| 48                | initiateDownloadSequence    |
| 49                | initiateUploadSequence      |
| 50                | input                       |
| 51                | kill                        |
| 52                | loadDomainContent           |
| 53                | obtainFile                  |
| 54                | output                      |
| 55                | read                        |
| 56                | readJournal                 |
| 57                | relinquishControl           |
| 58                | rename                      |
| 59                | reportActionStatus          |
| 60                | reportEventActionStatus     |
| 61                | reportEventConditionStatus  |
| 62                | reportEventEnrollmentStatus |
| 63                | reportJournalStatus         |
| 64                | reportPoolSemaphoreStatus   |
| 65                | reportSemaphoreEntryStatus  |
| 66                | reportSemaphoreStatus       |

| Service Operation | Service Operation Name    |
|-------------------|---------------------------|
| 67                | requestDomainDownLoad     |
| 68                | requestDomainUpload       |
| 69                | reset                     |
| 70                | resume                    |
| 71                | start                     |
| 72                | status                    |
| 73                | stop                      |
| 74                | storeDomainContent        |
| 75                | takeControl               |
| 76                | terminateDownloadSequence |
| 77                | terminateUploadSequence   |
| 78                | triggerEvent              |
| 79                | unsolicitedStatus         |
| 80                | uploadSegment             |
| 81                | write                     |
| 82                | writeJournal              |

# PoE Configuration Suggestions

This page shows the different PoE configuration suggestions that may be given and additional information about them.

| Item  | Description  |
|---|--|
| <b>Disable PoE power output</b>                                       | A NIC or unknown PD was detected; you may want to disable PoE power output for the port.                             |
| <b>Select Force Mode</b>  | A higher/lower resistance or higher capacitance was detected; you may want to select <b>Force Mode</b> for the port. |
| <b>Select high power output</b>                                       | An unknown classification was detected; you may want to select High Power output.                                    |
| <b>Raise the external power supply voltage to greater than 46 VDC</b> | When the external supply voltage is detected at less than 46 V, the system suggests raising the voltage.             |
| <b>Enable PoE function for detection</b>                              | The system suggests enabling the PoE function.   |
| <b>Select IEEE 802.3at auto mode</b>                                  | When detecting an IEEE 802.3at PD, the system suggests selecting 802.3at Auto mode.                                  |
| <b>Select IEEE 802.3af auto mode</b>                                  | When detecting an IEEE 802.3af PD, the system suggests selecting 802.3af Auto mode.                                  |

# Sample Local Consist Info File

The following example provides a copy-and-paste compatible Local Consist Info File for use with ETBN examples. This example assumes a single consist. Further modifications may be required for multi-consist examples.

Refer to [Structure and Syntax of Local Consist Info Files](#) for more information about XML configuration files.

```
<?xml version="1.0" encoding="UTF-8"?><!DOCTYPE consistinfo SYSTEM
"consistinfo.dtd"><consistinfo>  <cstId>consist1</cstId>
                                <cstOwner>Moxa</cstOwner>          <cstType>Regional
train</cstType> <vehicleinfo tractVeh="false">
                                <cstVehNo>1</cstVehNo>
                                <vehId>vehicle1</vehId>
                                <vehOrient>same</vehOrient>
                                <vehType>Passenger vehicle</vehType>
                                <functioninfo>
                                <cnId>1</cnId>
                                <fctId>112</fctId>
                                <fctName>devECSC</fctName>
                                </functioninfo>                                <functioninfo>
                                                                <cnId>1</cnId>
                                <fctId>11</fctId>
                                <fctName>devCam1</fctName>
                                </functioninfo>                                <functioninfo>
                                                                <cnId>1</cnId>
                                <fctId>20</fctId>
                                <fctName>grpDoor</fctName>
                                </functioninfo>                                <functioninfo>
                                                                <cnId>1</cnId>
                                <fctId>30</fctId>
                                <fctName>grpDoor1</fctName>
                                </functioninfo>  </vehicleinfo></consistinfo>
```

This page explains security practices for installing, operating, maintaining, and decommissioning the device. We strongly recommend that our customers follow these guidelines to enhance network and equipment security.



# Installation

## Physical Installation

1. The device **MUST** be installed in an access-controlled area, where only the necessary personnel have physical access to the device.
2. The device **MUST** be installed at the security perimeter or the boundary between different zones to provide network segmentation.
3. Please follow the instructions in the Quick Installation Guide, which is included in the package, to ensure you install the device correctly in your environment.
4. The device has anti-tamper labels on the enclosures. This allows an administrator to tell whether the device has been tampered with.
5. The ports that are not in use should be deactivated. Please refer to the [Ports](#) section for detailed instructions.

## Account Management

Follow these best practices when setting up an account:

1. Each account should be assigned the correct privileges: Only allow the minimum number of people to have admin privilege so they can perform device configuration or modifications, while other users should only have read access privilege. The device supports both local account authentication and a remote centralized mechanism, including RADIUS.
2. Change the default password, and strengthen the account password complexity by:
  - a. Enabling the "Password Policy" function.
  - b. Increasing the minimum password length to at least eight characters.
  - c. Defining a password policy to ensure that it contains at least an uppercase and lowercase letter, a digit, and a special character.
  - d. Setting user passwords to expire after a certain period of time.
3. Enforce regulations that ensure that only a trusted host can access the device. Please refer to the Trusted Access section for detailed instructions.

## Vulnerable Network Ports

1. For network security concerns, we strongly recommend that you change the port numbers, such as TCP port numbers for HTTP, HTTPS, Telnet, and SSH, for the protocols that are in use. Ports that are not in use but are still reachable pose an unacceptable security risk and should be disabled. Refer to the [Management Interface](#) section for detailed instructions.
2. In order to avoid eavesdroppers from snooping confidential information, users should adopt encryptionbased communication protocols, such as HTTPS instead of HTTP, SSH instead of Telnet, SFTP instead of TFTP, SNMPv3 instead of SNMPv1/v2c, etc. In addition, the maximum number of sessions should be kept to an absolute minimum. Please refer to the Management Interface section for detailed instructions.
3. Users should generate the SSL certificate for the device before commissioning HTTPS or SSH applications. Please refer to the [SSH & SSL](#) section for detailed instructions.

## Operation

In order to ensure that communications are properly protected, use a strong cryptographic algorithm for key exchange or encryption protocols for HTTPS/SSH applications. The device follows the NIST SP800-52 and SP800-131 standards and supports TLS v1.2 and v1.3 with the following cipher suites:

### TLS V1.2

| Cypher Suite Name                                  | Key Exchange | Authentication | Encryption        | Hash Function |
|--|--------------|----------------|-------------------|---------------|
| <b>TLS_ECDHE_RSA_WITH_CHACHA20_POLY1305_SHA256</b> | ECDHE        | RSA            | CHACHA20-POLY1305 | SHA256        |
| <b>TLS_ECDHE_ECDSA_WITH_AES_128_GCM_SHA256</b>     | ECDHE        | ECDSA          | AES128            | SHA256        |
| <b>TLS_ECDHE_RSA_WITH_AES_128_GCM_SHA256</b>       | ECDHE        | RSA            | AES128            | SHA256        |
| <b>TLS_ECDHE_RSA_WITH_AES_256_GCM_SHA384</b>       | ECDHE        | RSA            | AES256            | SHA384        |
| <b>TLS_DHE_RSA_WITH_AES_128_GCM_SHA256</b>         | Ephemeral DH | RSA            | AES128            | SHA256        |

| Cypher Suite Name                                    | Key Exchange | Authentication | Encryption        | Hash Function |
|--|--------------|----------------|-------------------|---------------|
| <b>TLS_DHE_RSA_WITH_AES_256_GCM_SHA384</b>           | Ephemeral DH | RSA            | AES256            | SHA384        |
| <b>TLS_DHE_RSA_WITH_CHACHA20_POLY1305_SHA256</b>     | Ephemeral DH | RSA            | CHACHA20-POLY1305 | SHA256        |
| <b>TLS_ECDHE_RSA_WITH_AES256_SHA384</b>              | ECDHE        | RSA            | AES256            | SHA384        |
| <b>TLS_ECDHE_RSA_WITH_AES_128_CBC_SHA256</b>         | ECDHE        | RSA            | AES128            | SHA256        |
| <b>TLS_ECDHE_ECDSA_WITH_CHACHA20_POLY1305_SHA256</b> | ECDHE        | ECDSA          | CHACHA20-POLY1305 | SHA256        |
| <b>TLS_ECDHE_RSA_WITH_AES_256_CBC_SHA384</b>         | ECDHE        | RSA            | AES256            | SHA384        |
| <b>TLS_ECDHE_ECDSA_WITH_AES_256_CBC_SHA384</b>       | ECDHE        | ECDSA          | AES256            | SHA384        |
| <b>TLS_ECDHE_ECDSA_WITH_AES_128_CBC_SHA256</b>       | ECDHE        | ECDSA          | AES128            | SHA256        |

### TLS V1.3

| Cypher Suite Name                   | Key Exchange | Authentication | Encryption        | Hash Function |
|-------------------------------------|--------------|----------------|-------------------|---------------|
| <b>TLS_AES_256_GCM_SHA384</b>       | Any          | N/A            | AES256 GCM        | SHA384        |
| <b>TLS_CHACHA20_POLY1305_SHA256</b> | Any          | N/A            | CHACHA20-POLY1305 | SHA256        |
| <b>TLS_AES_128_GCM_SHA256</b>       | Any          | N/A            | AES128 GCM        | SHA256        |

2. Below is a list of the recommended secure browsers that support TLS v1.2 or above:

| Browser                            | Version      |
|------------------------------------|--------------|
| <b>Microsoft Edge</b>              | All          |
| <b>Microsoft Internet Explorer</b> | v11 or above |
| <b>Mozilla Firefox</b>             | v27 or above |

| Browser              | Version      |
|----------------------|--------------|
| <b>Google Chrome</b> | v38 or above |
| <b>Apple Safari</b>  | v7 or above  |

Reference: <https://support.globalsign.com/ssl/general-ssl/tls-protocol-compatibility#Browsers>

The device supports event logs and syslog for SIEM integration:

- a. Event log: Due to limited storage capacity, the event log can only accommodate a maximum of 1,000 entries per category. Administrators can set a warning for a pre-defined threshold. We that users regularly back up system event logs. Please refer to the Event Log section for detailed instructions.
- b. Syslog: the device supports syslog, and advanced secure TLS-based syslog for centralized SIEM integration. Please refer to the Syslog section for detailed instructions.

4. The device can provide information for control system inventory:

- a. SNMPv1, v2c, v3: We recommend administrators use SNMPv3 with authentication and encryption to manage the network. Please refer to the [SNMP](#) for detailed instructions.
- b. Telnet/SSH: We recommend that administrators use SSH with authentication and encryption to retrieve device properties.
- c. HTTP/HTTPS: We recommend that administrators use HTTPS with a certificate that has been granted by a Certificate Authority to configure the device.

5. Denial of Service protection: To avoid disruption of the normal operation of the router, administrators should configure the QoS and DoS policy functions. The device supports ingress rate limiting and egress shaper. Administrators can decide how to deal with excess data flow and configure the device accordingly. This process will regulate the resulted data rate per port. Please refer to the [QoS](#) section for detailed instructions. Furthermore, the device provides 9 different DoS functions for detecting or defining abnormal packet formats or traffic flows. Please refer to the DoS (Denial of Service) Policy section for detailed instructions.

6. Time synchronization with authentication: Time synchronization is crucial for process control. To prevent malicious attacks whereby the settings are changed without permission, authentication must be in place between the NTP server and client. The

device supports NTP with a pre-shared key. Please refer to the Time section for detailed instructions.

7. Periodically regenerate the SSH and SSL certificates: Even though the device supports RSA 2048-bit and SHA-256 to ensure sufficient complexity, we strongly recommend that users frequently renew their SSH key and SSL certificate in case the key is compromised. Please refer to the SSH & SSL section for detailed instructions.

8. Below is the list for the protocol port numbers used for all external interfaces:

| Protocol   | Service Type | Port Number |
|------------|--------------|-------------|
| <b>TCP</b> | SSH          | 22          |
| <b>TCP</b> | Telnet       | 23          |
| <b>TCP</b> | HTTP         | 80          |
| <b>TCP</b> | HTTPS        | 443         |
| <b>UDP</b> | DHCP         | 67          |
| <b>UDP</b> | NTP          | 123         |
| <b>UDP</b> | SNMP         | 161         |
| <b>UDP</b> | Moxa Service | 40404       |

# Maintenance

1. Perform firmware upgrades frequently to enhance features, deploy security patches, or fix bugs.
2. Frequently back up the system configurations: In order to properly protect the system configuration files from being tampered with, the device supports password encryption and signature authentication for backup files.
3. Examine event logs frequently to detect any anomalies.
4. To report vulnerabilities of Moxa products, please submit your findings on the following web page: <https://www.moxa.com/en/support/product-support/security-advisory/report-a-vulnerability>.

# Decommission

To avoid any sensitive information such as your account password or certificate from being disclosed, always reset the system settings to factory default before decommissioning the device.

# Severity Level List

This is a list of severity levels and descriptions, which are based on CVSS vulnerability classifications.

| Severity            | Description                      |
|---------------------|----------------------------------|
| <b>Emergency</b>    | System is unusable               |
| <b>Alert</b>        | Action must be taken immediately |
| <b>Critical</b>     | Critical conditions              |
| <b>Error</b>        | Error conditions                 |
| <b>Warning</b>      | Warning conditions               |
| <b>Notice</b>       | Normal but significant condition |
| <b>Infomational</b> | Informational messages           |
| <b>Debug</b>        | Debug-level messages             |



# Status Codes

This page shows the different status codes for your device.

## Note

Available settings and options will vary depending on the product model.

## PoE Status Codes

### Classification

| Classification | Max Power (watts) by PSE Output |
|----------------|---------------------------------|
| <b>0</b>       | 15.4                            |
| <b>1</b>       | 4                               |
| <b>2</b>       | 7                               |
| <b>3</b>       | 15.4                            |
| <b>4</b>       | 30                              |

### Device Type

| Item               | Description                                  |
|--------------------|--|
| <b>Not Present</b> | There are no active connections to the port. |
| <b>802.3at</b>     | An IEEE 802.3at PD is connected to the port. |
| <b>802.3af</b>     | An IEEE 802.3af PD is connected to the port. |
| <b>NIC</b>         | A NIC is connected to the port.              |
| <b>Unknown</b>     | An unknown PD is connected to the port.      |
| <b>N/A</b>         | The PoE function is disabled.                |

## Configuration Suggestion

| Item  | Description  |
|---|--|
| <b>Disable PoE power output</b>                                       | A NIC or unknown PD was detected; you may want to disable PoE power output for the port.                             |
| <b>Select Force Mode</b>  | A higher/lower resistance or higher capacitance was detected; you may want to select <b>Force Mode</b> for the port. |
| <b>Select high power output</b>                                       | An unknown classification was detected; you may want to select High Power output.                                    |
| <b>Raise the external power supply voltage to greater than 46 VDC</b> | When the external supply voltage is detected at less than 46 V, the system suggests raising the voltage.             |
| <b>Enable PoE function for detection</b>                              | The system suggests enabling the PoE function.   |
| <b>Select IEEE 802.3at auto mode</b>                                  | When detecting an IEEE 802.3at PD, the system suggests selecting 802.3at Auto mode.                                  |
| <b>Select IEEE 802.3af auto mode</b>                                  | When detecting an IEEE 802.3af PD, the system suggests selecting 802.3af Auto mode.                                  |

# Structure and Syntax of Local Consist Info Files

A local consist info file uses XML syntax to represent consist information. It is composed of the physical vehicle information and the network device information within each vehicle.

The basic file structure is as follows:

```
<?xml version="1.0" encoding="UTF-8"?>
<consistinfo>
  <vehicleinfo>
    <functioninfo>
    </functioninfo>
  </vehicleinfo>
</consistinfo>
```

## consistinfo

The consistinfo element represents consist info. There must be only one consistinfo element per configuration file.

## Attributes

There are no attributes for this element.

## Child Elements

| Name           | Description   | Valid Range   |
|----------------|---|---|
| <b>cstId</b>   | Required. Specifies a unique ID for a consist. This is different than the Consist UUID.<br><br>The suggested naming convention for using a UIC for the cstId is:<br><i>"UIC" + (numerical part of UIC)</i><br><br>For example, the suggested cstId for UIC 508089-43503-8 would be <i>UIC508089435038</i> . | Valid XML element name that is 3 to 15 characters. A hyphen cannot be used as the last character. |
| <b>cstType</b> | Optional. Specifies the type of the consist.  | Valid XML element name that is 3 to 15 characters. A hyphen cannot be used as the last character. |

| Name               | Description   | Valid Range   |
|--------------------|---|---|
| <b>cstOwner</b>    | Optional. Specifies the owner of the consist.   | Valid XML element name that is 3 to 15 characters. A hyphen cannot be used as the last character. |
| <b>vehicleinfo</b> | Required. List of vehicle information that belongs to the consist. Refer to <a href="#">vehicleinfo</a> for more information. | The numbers of the vehicle information, ranges from 1 to 32                                       |

## functioninfo

The functioninfo element represents device or functional group information in the vehicle. There can be 0 to 1024 functioninfo elements within a vehicleinfo element.

### Attributes

There are no attributes for this element.

### Child Elements

| Name           | Description   | Valid Range   |
|----------------|---|---|
| <b>fctName</b> | <p>Required. Specifies a unique name for the device/functional group.</p> <p>For devices, we suggest using "dev" or "fct" as a prefix for the fctName. Examples: fctDoorCtrl, fctBrake, devHMI</p> <p>For functional groups, which represent multicast addresses, fctName should use "grp" as the prefix. Examples: grpDoorCtrl, grpBrake, grpETBN, grpECSC</p> | Valid XML element name that is 3 to 15 characters. A hyphen cannot be used as the last character. |
| <b>cnId</b>    | Required. Specifies the static CN ID of the ECN this device/functional group connects to. Set this to 0 for functional groups.  | Integer from 0 to 32  |
| <b>fctId</b>   | <p>Required. Specifies the numeric ID for the device/functional group. Must be different from the Host ID of the ECN.</p> <p>There should be no duplicate combinations of fctId and cnId within a single consist.</p>   | Integer from 1 to 32767   |

# vehicleinfo

The vehicleinfo element represents vehicle information in the consist. There should be 1 to 32 vehicleinfo elements within a [consistinfo](#) element.

## Attributes

| Name            | Value  | Valid Range  |
|-----------------|--|--------------|
| <b>leading</b>  | Required. Boolean that indicates whether ECSC is attached to this vehicle. | true / false |
| <b>tractVeh</b> | Optional. Boolean that indicates whether a vehicle has traction.           | true / false |

## Child Elements

| Name             | Description   | Valid Range   |
|------------------|---|---|
| <b>vehId</b>     | Required. Specifies a unique ID for a vehicle.<br>The suggested naming convention for using a UIC as for the vehId is:<br><i>"UIC" + (numerical part of UIC)</i><br>For example, suggested vehId for <i>UIC 508089-43501-2</i> would be <i>UIC508089435012</i> .  | Valid XML element name that is 3 to 15 characters. A hyphen cannot be used as the last character. |
| <b>vehType</b>   | Optional. Specifies the type of vehicle.  | Valid XML element name that is 3 to 15 characters. A hyphen cannot be used as the last character. |
| <b>vehOrient</b> | Required. Specifies the vehicle orientation with respect to the consist direction.<br><b>same:</b> Indicates that vehicle has the same direction with respect to the consist direction.<br><b>inverse:</b> Indicates that the vehicle is in the opposite direction with respect to the consist direction. | same / inverse  |
| <b>cstVehNo</b>  | Required. Specifies the index of the vehicle within the consist. Indexing starts from consist direction 1 to direction 2.<br>The first vehicle in consist direction 1 is assigned index 1. The second vehicle (next vehicle in direction 2 of first vehicle) has index 2, and so on.                      | Integer from 1 to 32  |

| Name                | Description   | Valid Range            |
|---------------------|---|------------------------|
| <b>functioninfo</b> | Required. List of devices/functional groups information within the vehicle. Refer to <a href="#">functioninfo</a> for more information.<br><br>Number of devices/function group information ranges from 0 to 1024 | Integer from 0 to 1024 |

# System Event List

This is a list of system events and their descriptions.

| Group             | System Event                       | Description   |
|-------------------|------------------------------------|---|
| <b>General</b>    | Cold Start                         | Power was cut off and then reconnected.   |
| <b>General</b>    | Warm Start                         | The device was rebooted, such as when network parameters are changed (IP address, netmask, etc.). |
| <b>General</b>    | Power 1 Transition (On->Off)       | The device's power 1 is powered down.   |
| <b>General</b>    | Power 1 Transition (Off->On)       | The device's power 1 is powered up.   |
| <b>General</b>    | Power 2 Transition (On->Off)       | The device's power 2 is powered down.   |
| <b>General</b>    | Power 2 Transition (Off->On)       | The device's power 2 is powered up.   |
| <b>General</b>    | Digital Input Transition (On->Off) | The device's input is turning off.  |
| <b>General</b>    | Digital Input Transition (Off->On) | The device's input is turning on.   |
| <b>General</b>    | Configuration Changed              | A configuration setting was changed.  |
| <b>General</b>    | Login Failure                      | An incorrect password was entered.  |
| <b>General</b>    | 802.1X Authentication Failure      | An 802.1X authentication failure occurred.  |
| <b>General</b>    | Firmware Upgrade Success           | Firmware upgrade was successful.  |
| <b>General</b>    | Firmware Upgrade Failure           | An error occurred during the firmware upgrade.  |
| <b>General</b>    | Log Service Ready                  | Log service is ready.   |
| <b>Redundancy</b> | Ring/RSTP Topology Changed         | The Ring/RSTP topology was changed.   |
| <b>Redundancy</b> | Master Mismatch                    | A Turbo Ring Master mismatch occurred.  |
| <b>Redundancy</b> | Coupling Topology Changed          | The Coupling topology was changed.  |

| Group             | System Event                        | Description  |
|-------------------|-------------------------------------|--|
| <b>Redundancy</b> | VRRP State Change                   | The VRRP state was changed.  |
| <b>VPN</b>        | VPN Connected                       | VPN has been connected.  |
| <b>VPN</b>        | VPN Disconnected                    | VPN has been disconnected.   |
| <b>PoE</b>        | PoE PD On                           | Port#N PD power on.  |
| <b>PoE</b>        | PoE PD Off                          | Port#N PD power off.   |
| <b>PoE</b>        | Over Measured Power limitation      | Over the total measured power limit.   |
| <b>PoE</b>        | PoE FETBad                          | PD Port#N MOSFET is bad.   |
| <b>PoE</b>        | PoE Over Temperature                | The temperature of the environment exceeds the maximum operating temperature of the device.              |
| <b>PoE</b>        | PoE VEE Uvlo                        | VEE (PoE input voltage) under Voltage Lockout. The voltage of the power supply has dropped below 44V DC. |
| <b>PoE</b>        | PoE PD Over Current                 | Current of Port#N has exceeded the safety limit.   |
| <b>PoE</b>        | PoE PD Check Fail                   | PD Port#N check failed.  |
| <b>PoE</b>        | Over Allocated Power limitation     | The total PD power consumption exceeds the total allocated power.  |
| <b>Cellular</b>   | IP Change                           | The cellular IP address of the device has changed.   |
| <b>Cellular</b>   | Cellular Module Failure             | The cellular module has encountered a failure and is not functioning.                                    |
| <b>Cellular</b>   | Detect SIM Failure                  | The system has detected a failure in the inserted SIM.   |
| <b>Cellular</b>   | PIN Code Failure                    | The device failed to validate the PIN code for the SIM card.   |
| <b>Cellular</b>   | SIM Switch                          | The active SIM has been switched to another SIM card.  |
| <b>Cellular</b>   | GuaranLink Cellular Reconnected     | GuaranLink has successfully reconnected the cellular network.  |
| <b>Cellular</b>   | Guaranlink Triggered ISP Reregister | GuaranLink triggered re-registration with the Internet Service Provider.                                 |



| Group                   | System Event                               | Description  |
|-------------------------|--|--|
| <b>Cellular</b>         | Guaranlink Triggered Cellular Module Reset | The cellular module was reset by GuaranLink due to an error condition.             |
| <b>Cellular</b>         | Guaranlink Triggered System Reboot         | GuaranLink triggered a system reboot due to error recovery.                        |
| <b>Power Management</b> | Power Saving Start                         | The device enters the power saving mode.   |
| <b>Power Management</b> | Power Saving End                           | The device leaves the power saving mode.   |
| <b>Power Management</b> | Scheduling Rule Expired                    | The power saving rule has passed the set end time.                                 |
| <b>SMS</b>              | Wrong Password                             | The password of the remote control SMS received by the device is wrong.            |
| <b>SMS</b>              | Wrong Command                              | The command of the remote control SMS received by the device is wrong.             |
| <b>SMS</b>              | Wrong Format                               | The format of the remote control SMS received by the device is wrong.              |
| <b>SMS</b>              | Command Disabled                           | The remote control SMS received by the device is not enabled.                      |
| <b>SMS</b>              | Trusted Number Authentication Failure      | The remote control SMS received by the device is not from the Trusted Number List. |
| <b>WAN Redundancy</b>   | WAN Interface Changed                      | The active WAN interface change to a different WAN interface.                      |
| <b>WAN Redundancy</b>   | WAN Interface Ping Failure                 | The active WAN interface fails to ping the specified server.                       |
| <b>Serial</b>           | Serial OP Mode State Changed               | The serial operational mode has changed.   |
| <b>Serial</b>           | Serial DSR State Changed                   | The Data Set Ready (DSR) state of the serial port has changed.                     |
| <b>Serial</b>           | Serial DCD State Changed                   | The Data Carrier Detect (DCD) state of the serial port has changed.                |
| <b>DHCP</b>             | DHCP Error Log                             | An error occurred in the DHCP process, and it has been logged.                     |
| <b>General</b>          | Fiber Check Warning                        | The system detected that monitored values exceeded their safety thresholds.        |

| Group                     | System Event                     | Description   |
|---------------------------|----------------------------------|---|
| <b>General</b>            | Layer 3 - 7 Policy Changed       | A user configured firewall rule in Layer 3-7 Policy has been added, modified, or deleted. |
| <b>IGMP Snooping</b>      | IGMP Snooping Error Log          | An error occurred in IGMP snooping and has been logged.                                   |
| <b>NTP/SNTP Error Log</b> | NTP/SNTP Error Log               | An error occurred in NTP/SNTP synchronization and has been logged.                        |
| <b>Redundancy</b>         | Ring/Chain/RSTP Topology Changed | The topology of the ring, chain, or RSTP network has changed.                             |

| Group          | System Event                       | Description   |
|----------------|------------------------------------|---|
| <b>General</b> | Cold Start                         | Power was cut off and then reconnected.   |
| <b>General</b> | Warm Start                         | The device was rebooted, such as when network parameters are changed (IP address, netmask, etc.). |
| <b>General</b> | Power 1 Transition (On->Off)       | The device's power 1 is powered down.   |
| <b>General</b> | Power 1 Transition (Off->On)       | The device's power 1 is powered up.   |
| <b>General</b> | Power 2 Transition (On->Off)       | The device's power 2 is powered down.   |
| <b>General</b> | Power 2 Transition (Off->On)       | The device's power 2 is powered up.   |
| <b>General</b> | Digital Input Transition (On->Off) | The device's input is turning off.  |
| <b>General</b> | Digital Input Transition (Off->On) | The device's input is turning on.   |
| <b>General</b> | Configuration Changed              | A configuration setting was changed.  |
| <b>General</b> | Login Failure                      | An incorrect password was entered.  |
| <b>General</b> | 802.1X Authentication Failure      | An 802.1X authentication failure occurred.  |
| <b>General</b> | Firmware Upgrade Success           | Firmware upgrade was successful.  |

| Group             | System Event                    | Description  |
|-------------------|---------------------------------|--|
| <b>General</b>    | Firmware Upgrade Failure        | An error occurred during the firmware upgrade.   |
| <b>General</b>    | Log Service Ready               | Log service is ready.  |
| <b>Redundancy</b> | Ring/RSTP Topology Changed      | The Ring/RSTP topology was changed.  |
| <b>Redundancy</b> | Master Mismatch                 | A Turbo Ring Master mismatch occurred.   |
| <b>Redundancy</b> | Coupling Topology Changed       | The Coupling topology was changed.   |
| <b>Redundancy</b> | VRRP State Change               | The VRRP state was changed.  |
| <b>VPN</b>        | VPN Connected                   | VPN has been connected.  |
| <b>VPN</b>        | VPN Disconnected                | VPN has been disconnected.   |
| <b>PoE</b>        | PoE PD On                       | Port#N PD power on.  |
| <b>PoE</b>        | PoE PD Off                      | Port#N PD power off.   |
| <b>PoE</b>        | Over Measured Power limitation  | Over the total measured power limit.   |
| <b>PoE</b>        | PoE FETBad                      | PD Port#N MOSFET is bad.   |
| <b>PoE</b>        | PoE Over Temperature            | The temperature of the environment exceeds the maximum operating temperature of the device.              |
| <b>PoE</b>        | PoE VEE Uvlo                    | VEE (PoE input voltage) under Voltage Lockout. The voltage of the power supply has dropped below 44V DC. |
| <b>PoE</b>        | PoE PD Over Current             | Current of Port#N has exceeded the safety limit.   |
| <b>PoE</b>        | PoE PD Check Fail               | PD Port#N check failed.  |
| <b>PoE</b>        | Over Allocated Power limitation | The total PD power consumption exceeds the total allocated power.  |
| <b>Cellular</b>   | IP Change                       | The cellular IP address of the device has changed.   |
| <b>Cellular</b>   | Cellular Module Failure         | The cellular module has encountered a failure and is not functioning.                                    |
| <b>Cellular</b>   | Detect SIM Failure              | The system has detected a failure in the inserted SIM.   |

| Group                   | System Event                               | Description  |
|-------------------------|--|--|
| <b>Cellular</b>         | PIN Code Failure                           | The device failed to validate the PIN code for the SIM card.                       |
| <b>Cellular</b>         | SIM Switch                                 | The active SIM has been switched to another SIM card.                              |
| <b>Cellular</b>         | GuaranLink Cellular Reconnected            | GuaranLink has successfully reconnected the cellular network.                      |
| <b>Cellular</b>         | Guaranlink Triggered ISP Reregister        | GuaranLink triggered re-registration with the Internet Service Provider.           |
| <b>Cellular</b>         | Guaranlink Triggered Cellular Module Reset | The cellular module was reset by GuaranLink due to an error condition.             |
| <b>Cellular</b>         | Guaranlink Triggered System Reboot         | GuaranLink triggered a system reboot due to error recovery.                        |
| <b>Power Management</b> | Power Saving Start                         | The device enters the power saving mode.   |
| <b>Power Management</b> | Power Saving End                           | The device leaves the power saving mode.   |
| <b>Power Management</b> | Scheduling Rule Expired                    | The power saving rule has passed the set end time.                                 |
| <b>SMS</b>              | Wrong Password                             | The password of the remote control SMS received by the device is wrong.            |
| <b>SMS</b>              | Wrong Command                              | The command of the remote control SMS received by the device is wrong.             |
| <b>SMS</b>              | Wrong Format                               | The format of the remote control SMS received by the device is wrong.              |
| <b>SMS</b>              | Command Disabled                           | The remote control SMS received by the device is not enabled.                      |
| <b>SMS</b>              | Trusted Number Authentication Failure      | The remote control SMS received by the device is not from the Trusted Number List. |
| <b>WAN Redundancy</b>   | WAN Interface Changed                      | The active WAN interface change to a different WAN interface.                      |
| <b>WAN Redundancy</b>   | WAN Interface Ping Failure                 | The active WAN interface fails to ping the specified server.                       |
| <b>Serial</b>           | Serial OP Mode State Changed               | The serial operational mode has changed.   |

| Group                     | System Event                     | Description   |
|---------------------------|----------------------------------|---|
| <b>Serial</b>             | Serial DSR State Changed         | The Data Set Ready (DSR) state of the serial port has changed.                            |
| <b>Serial</b>             | Serial DCD State Changed         | The Data Carrier Detect (DCD) state of the serial port has changed.                       |
| <b>DHCP</b>               | DHCP Error Log                   | An error occurred in the DHCP process, and it has been logged.                            |
| <b>General</b>            | Device Lockdown State Change     | The device lockdown learning status has changed.  |
| <b>General</b>            | Fiber Check Warning              | The system detected that monitored values exceeded their safety thresholds.               |
| <b>General</b>            | Layer 3 - 7 Policy Changed       | A user configured firewall rule in Layer 3-7 Policy has been added, modified, or deleted. |
| <b>IGMP Snooping</b>      | IGMP Snooping Error Log          | An error occurred in IGMP snooping and has been logged.                                   |
| <b>NTP/SNTP Error Log</b> | NTP/SNTP Error Log               | An error occurred in NTP/SNTP synchronization and has been logged.                        |
| <b>Redundancy</b>         | Ring/Chain/RSTP Topology Changed | The topology of the ring, chain, or RSTP network has changed.                             |

# TRDP Message Type List

## Configuration attribute requirements - msgType

This is a list of TRDP msgTypes and their descriptions.

| msgType   | Description                          |
|-----------|--------------------------------------|
| <b>Pr</b> | PD Request                           |
| <b>Pp</b> | PD Reply                             |
| <b>Pd</b> | PD Data                              |
| <b>Pe</b> | PD Data (Error)                      |
| <b>Mn</b> | Notification (Request without reply) |
| <b>Mr</b> | MD Request with reply                |
| <b>Mp</b> | MD Reply without confirmation        |
| <b>Mq</b> | MD Reply with confirmation           |
| <b>Mc</b> | MD Confirm                           |
| <b>Me</b> | MD error                             |

## Configuration attribute requirements - msgType

### Profile

This is a list of TRDP msgType profiles and their descriptions.

| Profile       | Description                              |
|---------------|--|
| <b>PD-PDU</b> | A collection of "Pr, Pp, Pd, Pe"         |
| <b>MD-PDU</b> | A collection of "Mn, Mr, Mp, Mq, Mc, Me" |

# TRDP Protocol Filter Profile List

This is a list of the different built-in protocol filter profiles for common applications and their corresponding message types and communication identifiers.

| Protocol Filter Profile                                | Message Type   | Communication Identifier (ComID) |
|--|--|----------------------------------|
| <b>PD-PDU</b>  | 0x5072: PD Request, 0x5070: PD Reply, 0x5064: PD Data, 0x5065: PD Data (Error)   | All                              |
| <b>MD-PDU</b>  | 0x4D6E: Notification (Request without reply), 0x4D72: MD Request with reply, 0x4D70: MD Reply without confirmation, -x4D71: MD Reply with confirmation, 0x4D63: MD Confirm, 0x4D65: MD error | All                              |
| <b>Communication Framework and ETB Control Service</b> | All  | 1-29, 50-79, 150-199             |
| <b>TRDP statistics data</b>                            | All  | 30-41                            |
| <b>Conformance test</b>                                | All  | 80-99                            |
| <b>TTDB</b>  | All  | 100-119                          |
| <b>ECSP</b>  | All  | 120-129                          |
| <b>ETBN</b>  | All  | 130-139                          |
| <b>TCN-DNS</b>   | All  | 140-149                          |

# User Role Privileges

This page shows the privilege levels granted to the different authority levels: Admin, Supervisor, and User. Refer to [System > Account Management > User Accounts](#) for more information on user accounts.

Privileges are indicated as follows:

- **R/W**: Read and write access granted for the relevant settings
- **R**: Read-only access granted for the relevant settings
- **-**: No access granted for the relevant settings

**Note**

Available settings and options will vary depending on the product model.

## System

| Settings                                | Admin | Supervisor | User |
|---|-------|------------|------|
| <b>System Management</b>                |       |            |      |
| <b>Information Settings</b>             | R/W   | R/W        | R    |
| <b>Firmware Upgrade</b>                 | R/W   | -          | -    |
| <b>Software Package Management</b>      | R/W   | -          | -    |
| <b>Configuration Backup and Restore</b> | R/W   | -          | -    |
| <b>Account Management</b>               |       |            |      |
| <b>User Account</b>                     | R/W   | -          | -    |
| <b>Password Policy</b>                  | R/W   | -          | -    |
| <b>License Management</b>               | R/W   | R          | R    |
| <b>Management Interface</b>             |       |            |      |
| <b>Out of Band Management</b>           | R/W   | R/W        | R    |



| Settings                   | Admin | Supervisor | User |
|----------------------------|-------|------------|------|
| <b>User Interface</b>      | R/W   | R/W        | R    |
| <b>Hardware Interface</b>  | R/W   | R/W        | R    |
| <b>SNMP</b>                | R/W   | -          | -    |
| <b>Moxa Remote Connect</b> | R/W   | -          | -    |
| <b>MXsecurity</b>          | R/W   | R/W        | -    |
| <b>Time</b>                |       |            |      |
| <b>System Time</b>         | R/W   | R/W        | R    |
| <b>NTP/SNTP Server</b>     | R/W   | R/W        | R    |
| <b>Power Management</b>    | R/W   | R/W        | R    |
| <b>SMS</b>                 | R/W   | R/W        | R    |
| <b>GNSS</b>                | R/W   | R/W        | R    |
| <b>Setting Check</b>       | R/W   | R/W        | R    |

## Cellular

| Settings        | Admin | Supervisor | User |
|-----------------|-------|------------|------|
| <b>Cellular</b> | R/W   | R/W        | R    |

## Serial

| Settings      | Admin | Supervisor | User |
|---------------|-------|------------|------|
| <b>Serial</b> | R/W   | R/W        | R    |

# Network Configuration

| Settings                      | Admin | Supervisor | User |
|-------------------------------|-------|------------|------|
| <b>Ports</b>                  |       |            |      |
| <b>Port Settings</b>          | R/W   | R/W        | R    |
| <b>Link Aggregation</b>       | R/W   | R/W        | R    |
| <b>PoE</b>                    | R/W   | R/W        | R    |
| <b>Link Fault Passthrough</b> | R/W   | R/W        | R    |
| <b>LAN Bypass Gen3</b>        | R/W   | R/W        | R    |
| <b>Layer 2 Switching</b>      |       |            |      |
| <b>VLAN</b>                   | R/W   | R/W        | R    |
| <b>MAC Address Table</b>      | R/W   | R/W        | R    |
| <b>QoS</b>                    | R/W   | R/W        | R    |
| <b>Rate Limit</b>             | R/W   | R/W        | R    |
| <b>Multicast</b>              | R/W   | R/W        | R    |
| <b>Network Interfaces</b>     | R/W   | R/W        | R    |

# Redundancy

| Settings                  | Admin | Supervisor | User |
|---------------------------|-------|------------|------|
| <b>Layer 2 Redundancy</b> |       |            |      |
| <b>Spanning Tree</b>      | R/W   | R/W        | R    |
| <b>Turbo Ring V2</b>      | R/W   | R/W        | R    |
| <b>Turbo Chain</b>        | R/W   | R/W        | R    |

| Settings                  | Admin | Supervisor | User |
|---------------------------|-------|------------|------|
| <b>Layer 3 Redundancy</b> |       |            |      |
| <b>VRRP</b>               | R/W   | R/W        | R    |
| <b>WAN Redundancy</b>     | R/W   | R/W        | R    |

## Network Service

| Settings           | Admin | Supervisor | User |
|--------------------|-------|------------|------|
| <b>DHCP Server</b> | R/W   | R/W        | R    |
| <b>Dynamic DNS</b> | R/W   | R/W        | R    |
| <b>DNS Server</b>  | R/W   | R/W        | R    |

## Routing

| Settings                          | Admin | Supervisor | User |
|-----------------------------------|-------|------------|------|
| <b>Unicast Routing</b>            |       |            |      |
| <b>Static Routes</b>              | R/W   | R/W        | R    |
| <b>RIP</b>                        | R/W   | R/W        | R    |
| <b>OSPF</b>                       | R/W   | R/W        | R    |
| <b>Routing Table</b>              | R     | R          | R    |
| <b>Multicast Route</b>            |       |            |      |
| <b>Multicast Route Settings</b>   | R/W   | R/W        | R    |
| <b>Static Multicast Route</b>     | R/W   | R/W        | R    |
| <b>Multicast Forwarding Table</b> | R     | R          | R    |

| Settings                    | Admin | Supervisor | User |
|-----------------------------|-------|------------|------|
| <b>Broadcast Forwarding</b> | R/W   | R/W        | R    |

## NAT

| Settings   | Admin | Supervisor | User |
|------------|-------|------------|------|
| <b>NAT</b> | R/W   | R/W        | R    |

## Object Management

| Settings                 | Admin | Supervisor | User |
|--------------------------|-------|------------|------|
| <b>Object Management</b> | R/W   | R/W        | R    |

## Firewall

| Settings                   | Admin | Supervisor | User |
|----------------------------|-------|------------|------|
| <b>Layer 2 Policy</b>      | R/W   | R/W        | R    |
| <b>Layer 3 - 7 Policy</b>  | R/W   | R/W        | R    |
| <b>Layer 3 Policy</b>      | R/W   | R/W        | R    |
| <b>Malformed Packets</b>   | R/W   | R/W        | R    |
| <b>Session Control</b>     | R/W   | R/W        | R    |
| <b>DoS Policy</b>          | R/W   | R/W        | R    |
| <b>Soft Lockdown Mode</b>  | R/W   | R/W        | R    |
| <b>Advanced Protection</b> |       |            |      |
| <b>Dashboard</b>           | R/W   | R/W        | -    |

| Settings                      | Admin | Supervisor | User |
|-------------------------------|-------|------------|------|
| <b>Configuration</b>          | R/W   | R/W        | -    |
| <b>Protocol Filter Policy</b> | R/W   | R/W        | -    |
| <b>ADP</b>                    | R/W   | R/W        | -    |
| <b>IPS</b>                    | R/W   | R/W        | -    |
| <b>Device Lockdown</b>        | R/W   | R/W        | R    |

## VPN

| Settings              | Admin | Supervisor | User |
|-----------------------|-------|------------|------|
| <b>IPsec</b>          | R/W   | R/W        | R    |
| <b>L2TP Server</b>    | R/W   | R/W        | R    |
| <b>OpenVPN Client</b> | R/W   | R/W        | -    |

## Certificate Management

| Settings                           | Admin | Supervisor | User |
|------------------------------------|-------|------------|------|
| <b>Local Certificate</b>           | R/W   | -          | -    |
| <b>Trusted CA Certificate</b>      | R/W   | -          | -    |
| <b>Certificate Signing Request</b> | R/W   | -          | -    |

## Security

| Settings               | Admin | Supervisor | User |
|------------------------|-------|------------|------|
| <b>Device Security</b> |       |            |      |

| Settings                         | Admin | Supervisor | User |
|----------------------------------|-------|------------|------|
| <b>Login Policy</b>              | R/W   | R          | R    |
| <b>Trusted Access</b>            | R/W   | R/W        | R    |
| <b>SSH &amp; SSL</b>             | R/W   | R/W        | -    |
| <b>Network Security</b>          |       |            |      |
| <b>IEEE 802.1X</b>               | R/W   | R/W        | R    |
| <b>Authentication</b>            |       |            |      |
| <b>Login Authentication</b>      | R/W   | -          | -    |
| <b>RADIUS</b>                    | R/W   | -          | -    |
| <b>TACACS+</b>                   | R/W   | -          | -    |
| <b>MXview Alert Notification</b> | R/W   | R/W        | R    |

## Diagnostics

| Settings                             | Admin | Supervisor | User |
|--------------------------------------|-------|------------|------|
| <b>System Status</b>                 |       |            |      |
| <b>Utilization</b>                   | R/W   | R/W        | R    |
| <b>Fiber Check</b>                   | R/W   | R/W        | R    |
| <b>Network Status</b>                |       |            |      |
| <b>Network Statistics</b>            | R     | R          | R    |
| <b>LLDP</b>                          | R/W   | R/W        | R    |
| <b>ARP Table</b>                     | R     | R          | R    |
| <b>Event Log &amp; Notifications</b> |       |            |      |
| <b>Event Log</b>                     | R/W   | R/W        | R    |

| Settings                   | Admin | Supervisor | User |
|----------------------------|-------|------------|------|
| <b>Event Notifications</b> | R/W   | R/W        | R    |
| <b>Syslog</b>              | R/W   | R          | R    |
| <b>SNMP Trap/Inform</b>    | R/W   | -          | -    |
| <b>Email Settings</b>      | R/W   | R          | R    |
| <b>SMS Settings</b>        | R/W   | R          | R    |
| <b>Tools</b>               |       |            |      |
| <b>Port Mirroring</b>      | R/W   | R/W        | R    |
| <b>Ping</b>                | R/W   | R/W        | R    |
| <b>Diagnostic Support</b>  | R/W   | R/W        | R    |
| <b>NetFlow</b>             | R/W   | R/W        | R    |

## Industrial Application

| Settings                       | Admin | Supervisor | User |
|--------------------------------|-------|------------|------|
| <b>IEC 61375</b>               |       |            |      |
| <b>Ethernet Train Backbone</b> | R/W   | R/W        | R    |
| <b>Communication profile</b>   | R/W   | R/W        | R    |
| <b>Operational Status</b>      | R/W   | R/W        | R    |



**Moxa Inc.**

Copyright © 2025 Moxa, Inc. All rights reserved. Reproduction without permission is prohibited. Trademarks and logos are copyrights of their respective owners.

[www.moxa.com/products](http://www.moxa.com/products)