

AWK Series User Manual

Version 3.1, January 2025

www.moxa.com/products

Models covered by this user manual:

AWK-1151C Series

AWK-3252A Series

AWK-4252A Series



© 2025 Moxa Inc. All rights reserved.

AWK Series User Manual

The software described in this manual is furnished under a license agreement and may be used only in accordance with the terms of that agreement.

Copyright Notice

© 2025 Moxa Inc. All rights reserved.

Trademarks

The MOXA logo is a registered trademark of Moxa Inc.
All other trademarks or registered marks in this manual belong to their respective manufacturers.

Disclaimer

- Information in this document is subject to change without notice and does not represent a commitment on the part of Moxa.
- Moxa provides this document as is, without warranty of any kind, either expressed or implied, including, but not limited to, its particular purpose. Moxa reserves the right to make improvements and/or changes to this manual, or to the products and/or the programs described in this manual, at any time.
- Information provided in this manual is intended to be accurate and reliable. However, Moxa assumes no responsibility for its use, or for any infringements on the rights of third parties that may result from its use.
- This product might include unintentional technical or typographical errors. Changes are periodically made to the information herein to correct such errors, and these changes are incorporated into new editions of the publication.

Technical Support Contact Information

www.moxa.com/support

Table of Contents

1. About This Manual	5
Symbol Definition for Web Interface Configurations	5
About Note, Attention, and Warning	6
Configuration Reminders	7
A: About Mandatory Parameters	7
B: Preconfiguring Settings	8
2. Getting Started	9
Functional Design	9
LED Indicators	9
Event Indicators	12
Event Indicators (enabled Mesh Mode)	13
Beeper	13
Reset Button	13
Relay (AWK-3252A and AWK-4252A Only)	13
First-time Installation and Configuration	14
Communication Testing	17
3. Web Interface Configuration	19
Function Introduction	19
Device Summary	20
Device Information	20
System Information	20
System Status	21
SSID	21
System	22
System Management	22
Account Management	37
Management Interface	43
Time	48
Wi-Fi	52
Wireless Settings	52
Connection Management	73
Roaming	81
Client Isolation	83
Wi-Fi ACL	84
Ports	85
Port Settings	85
Layer 2 Switching	87
VLAN	87
IP Configuration	92
General Settings	92
IP Configuration Status	93
Network	97
DHCP Server	97
DHCPv6 Server	98
Gratuitous ARP (for Client/Client-router mode only)	100
Routing and NAT	101
Routing	102
NAT	104
Firewall	110
Layer 2 Policy	110
Layer 3 Policy	112
Certificate Management	115
Device Certificate	115
Server CA Certificate	116
Security	117
Device Security	117
Diagnostics	120
System Status	120

Network Status	123
Event Logs and Notifications	126
Tools	137
Setup Wizard	145
Wi-Fi Basic	145
Wi-Fi Security	147
System	149
Maintenance and Tools	151
Language	152
Disable Auto Save	153
Locator	154
Reboot.....	156
Reset to Defaults.....	157
Renew Device Unique Key	158
Change Password	159
Log Out.....	160
A. Supporting Information	161
Device Recovery	161
B. Accessing the Serial Consoles.....	163
RS-232 Console Configuration (115200, None, 8, 1, VT100)	163
Configuration by Telnet and SSH Consoles	165
C. Security Guidelines	167
Installation	167
Physical Installation	167
Account Management.....	168
Vulnerable Protocols	168
Operation	169
Maintenance	169
Decommission.....	170
D. Service Authority Table	171

1. About This Manual

Thank you for purchasing a Moxa's AWK-3252A Series/AWK-4252A Series/AWK-1151C Series product, referred to as 'AWK Series' in this manual. Read this user's manual to learn how to connect your Moxa product with various interfaces and how to configure all settings and parameters via the user-friendly web interface. Note that the web interface screenshots shown in this manual use the AWK-3252A Series for reference. Since all AWK Series use the same firmware image, the screenshots will be identical for all models, with the exception of the model name.

Three methods can be used to connect to the Moxa's device, which all will be described in the next two chapters. See the following descriptions for each chapter's main functions.

Chapter 2: Getting Started











In this chapter, we explain the instruction on how to initialize the configuration on Moxa's product. We provide three interfaces to access the configuration settings: RS-232 console interface, SSH/Telnet CLI (Command Line Interface), and web interface.



















Chapter 3: Web Interface Configuration

In this chapter, we explain how to access the Moxa AWK-3252A's various configuration, monitoring, and management functions. These functions can be accessed through a web browser, or through the command line console (CLI). In this manual, we describe how to configure the AWK Series functions via the web interface, which provides the most user-friendly way to configure a Moxa device. For more information on how to configure the AWK Series using the command line interface, refer to the AWK Series Command Line Interface User Manual.

Symbol Definition for Web Interface Configurations

The Web Interface Configuration includes various symbols. For your convenience, refer to the following table for the meanings of the symbols.

Symbols	Meanings
	Add
	Read detailed information
	Clear all
	Column selection
	Refresh
	Enable/Disable Auto Save When Auto Save is disabled, users need to click this icon to save the configuration.
	Export
	Edit
	Perform a Wi-Fi site survey (Client mode only)
	Re-authentication
	Delete

Symbols	Meanings
	Panel View
	Expand
	Collapse
	Hint or additional information
	Settings
	Data comparison
	Menu icon
	Change mode
	Locator
	Reboot
	Reset to defaults
	Logout
	Increase
	Decrease
	Equal
	Menu
	Search
	Hide text that is typed into a text box (usually used when typing a password)
	Show text typed into a text box (usually used when checking a password)

About Note, Attention, and Warning

Throughout the whole manual, you may see notes, attentions, and warnings. The definition of each type is explained below.

Note: This is used to provide additional information for a function, feature, or scenario. Here is an example:



NOTE

Reset to Default button is disabled by default; users need to enable it in the web console if they want to use it.

Attention: This is used to notify readers of matters or situations that require extra attention to avoid possible issues. Here is an example:



ATTENTION

When a different type of module has been inserted into the AWK Series, we suggest you configure the settings, or use reset-to-default.

Warning: This is used to notify readers of matters or situations that require extra attention to avoid serious harm to the user or the device. Here is an example:



WARNING

There is a risk of explosion if the battery is replaced by an incorrect type.

Configuration Reminders

In this section, several examples will be used to remind users when configuring the settings for Moxa's AWK Series.

A: About Mandatory Parameters

Create Static Route Entry

Entry Status *
Disabled

Name
0 / 31

Destination *
Required

Netmask *
24 (255.255.255.0)

Next Hop

Interface *
WAN

Metric

CANCEL CREATE

- The items with asterisks mean they are mandatory parameters that must be provided. In the figure above, the parameters for Entry Status, Destination, and Interface are required to be able to save or apply the configuration.
- If an item is marked in red means this item has been skipped. You need to fill in the parameters or you cannot apply or create the function.
- Some parameter values will be limited to a specific range. If the values exceed the range, it cannot be applied or created.
- Configuration input fields universally do not allow the following special characters: backslash (\), apostrophe ('), double quotes ("), backtick (`).

B: Preconfiguring Settings

Some function settings can be configured while the function is disabled. These changes will take effect when the function is enabled, without having to reconfigure the settings again. For example, on the SNMP configuration page, users can configure the SNMP Account List settings while SNMP is disabled. When SNMP is enabled, the previously configured Account List settings will take effect.

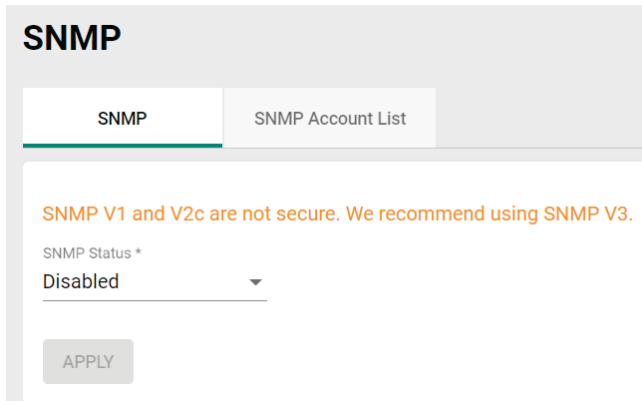

The screenshot shows the 'SNMP' configuration page. At the top, there are two tabs: 'SNMP' (which is selected and highlighted with a green underline) and 'SNMP Account List'. Below the tabs, there is a warning message in orange text: 'SNMP V1 and V2c are not secure. We recommend using SNMP V3.' Underneath the warning, there is a label 'SNMP Status *' followed by a dropdown menu currently set to 'Disabled'. At the bottom left of the configuration area, there is a grey 'APPLY' button.

2. Getting Started

In this chapter, we provide an overview of the AWK Series, and explain how to log into the Moxa's AWK Series for the first time through the web-based interface.

Functional Design

LED Indicators

The LEDs on the front and right panels of the AWK Series provide a quick and easy means of determining the current operational status and wireless settings.

AWK-4252A Series

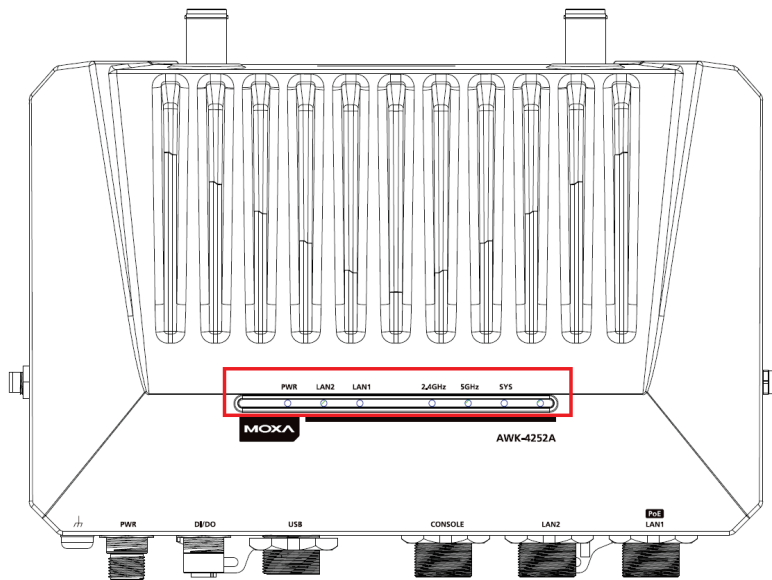

The following table summarizes how to read the device's wireless settings from the LED displays.

LED	Color	State	Description
Front Panel LED Indicators (System)			
PWR	Green	On	Power is being supplied from DC to the PWR socket (power input 1 or 2) or PoE.
		Off	Power is not being supplied from DC to the PWR socket (power input 1 or 2) or PoE.
LAN 2	Green	On	Link established on the LAN port at 1000 Mbps.
		Blinking	Data is being transmitted at 1000 Mbps.
		Off	The LAN port's 1000 Mbps link is inactive.
	Amber	On	Link established on the LAN port at 10/100 Mbps.
		Blinking	Data is being transmitted at 10/100 Mbps.
		Off	The LAN port's 10/100 Mbps link is inactive.
LAN 1	Green	On	Link established on the LAN port at 1000 Mbps.
		Blinking	Data is being transmitted at 1000 Mbps.
		Off	LAN port's 1000 Mbps link is inactive.
	Amber	On	Link established on the LAN port at 10/100 Mbps.
		Blinking	Data is being transmitted at 10/100 Mbps.
		Off	The LAN port's 10/100 Mbps link is inactive.

LED	Color	State	Description
2.4GHz	Green	On	Client/Client-Router/Slave has established a Wi-Fi connection to an AP/Master with a SNR value of 35 or higher.
		Blinking	Data is being transmitted over the 2.4 GHz band.
	Amber	On	Client/Client-Router/Slave has established a Wi-Fi connection to an AP/Master with a SNR value of less than 35.
		Blinking	Data is being transmitted over the 2.4 GHz band.
5GHz	Green	On	Client/Client-Router/Slave established a Wi-Fi connection to an AP/Master with a SNR value of 35 or higher.
		Blinking	Data is being transmitted over the 5 GHz band.
	Amber	On	Client/Client-Router/Slave has established a Wi-Fi connection to an AP/Master with a SNR value of less than 35.
		Blinking	Data is being transmitted over the 5 GHz band.
SYS	Red	On	System initialization failure, configuration error, or system error.
	Green	On	System startup completed and is operating normally.

AWK-3252A Series

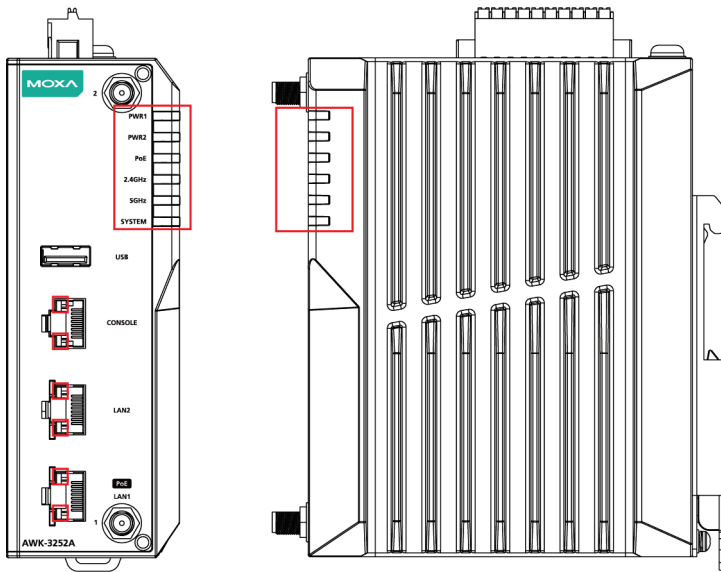

The following table summarizes how to read the device's wireless settings from the LED displays.

LED	Color	State	Description
Front Panel LED Indicators (System)			
PWR1	Green	On	Power is being supplied from power input 1.
		Off	Power is not being supplied from power input 1.
PWR2	Green	On	Power is being supplied from power input 2.
		Off	Power is not being supplied from power input 2.
PoE	Amber	On	Power is being supplied via PoE.
		Off	Power is not being supplied via PoE.
SYS	Red	On	System initialization failure, configuration error, or system error.
	Green	On	System startup completed and is operating normally.
2.4GHz	Green	On	Client/Client-Router/Slave has established a Wi-Fi connection to an AP/Master with a SNR value of 35 or higher.
		Blinking	Data is being transmitted over the 2.4 GHz band.
	Amber	On	Client/Client-Router/Slave has established a Wi-Fi connection to an AP/Master with a SNR value of less than 35.
		Blinking	Data is being transmitted over the 2.4 GHz band.
5GHz	Green	On	Client/Client-Router/Slave established a Wi-Fi connection to an AP/Master with a SNR value of 35 or higher.
		Blinking	Data is being transmitted over the 5 GHz band.
	Amber	On	Client/Client-Router/Slave has established a Wi-Fi connection to an AP/Master with a SNR value of less than 35.
		Blinking	Data is being transmitted over the 5 GHz band.

LED	Color	State	Description
LAN LED Indicators (RJ45 Port)			
LAN 1	Green	On	Link established on the LAN port at 1000 Mbps.
		Blinking	Data is being transmitted at 1000 Mbps.
		Off	The LAN port's 1000 Mbps link is inactive.
	Amber	On	Link established on the LAN port at 10/100 Mbps.
		Blinking	Data is being transmitted at 10/100 Mbps.
LAN 2	Green	On	Link established on the LAN port at 1000 Mbps.
		Blinking	Data is being transmitted at 1000 Mbps.
		Off	LAN port's 1000 Mbps link is inactive.
	Amber	On	Link established on the LAN port at 10/100 Mbps.
		Blinking	Data is being transmitted at 10/100 Mbps.
		Off	The LAN port's 10/100 Mbps link is inactive.

AWK-1151C Series

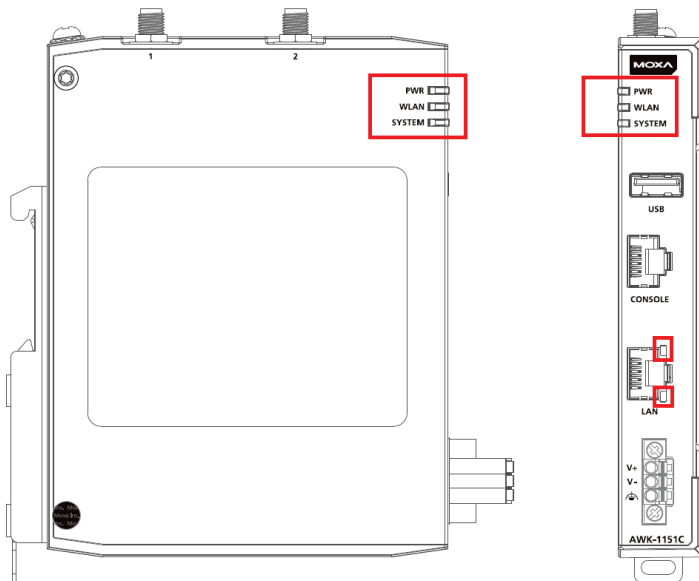

The following table summarizes how to read the device's wireless settings from the LED displays.

LED	Color	State	Description
Front Panel LED Indicators (System)			
PWR	Green	On	Power is being supplied from DC to the PWR socket.
		Off	Power is not being supplied from DC to the PWR socket.
WLAN	Green	On	Client/Client-Router/Slave has established a Wi-Fi connection to an AP/Master with a SNR value of 35 or higher.
		Blinking	Data is being transmitted over the wireless interface (2.4 GHz or 5 GHz).
	Amber	On	Client/Client-Router/Slave has established a Wi-Fi connection to an AP/Master with a SNR value of less than 35.
		Blinking	Data is being transmitted over the wireless interface (2.4 GHz or 5 GHz).
SYSTEM	Red	On	System initialization failure, configuration error, or system error.
	Green	On	System startup completed and is operating normally.
LAN LED Indicators (RJ45 Port)			
LAN	Green	On	Link established on the LAN port at 1000 Mbps.
		Blinking	Data is being transmitted at 1000 Mbps.
		Off	LAN port's 1000 Mbps link is inactive.
	Amber	On	Link established on the LAN port at 10/100 Mbps.
		Blinking	Data is being transmitted at 10/100 Mbps.
		Off	The LAN port's 10/100 Mbps link is inactive.

Event Indicators

The device LEDs are also used to indicate specific device events or issues. Refer to the following table for more details.

Applicable Models	AWK-3252A AWK-4252A AWK-1151C		AWK-3252A AWK-4252A				AWK-1151C	
	SYS		2.4 GHz		5 GHz		WLAN	
	Red	Green	Amber	Green	Amber	Green	Amber	Green
IP address conflict	Blinks at 4 Hz	Off	-	-	-	-	-	-
Failed to get an IP from the DHCP server	Blinks at 4 Hz	Off	-	-	-	-	-	-
ABC-02 is connected	Off	Blinks at 4 Hz	-	-	-	-	-	-
Uploading/retrieving file(s) to/from ABC-02 (e.g., upgrading firmware, backup/restore configuration)	Off	Blinks at 4 Hz	Off	Blinks at 4 Hz	Off	Blinks at 4 Hz	Off	Blinks at 4 Hz
Failed to upload/retrieve file(s) to/from ABC-02. Possible reasons are: The file does not exist, failed to copy the file, or the ABC-02 has insufficient space	Blinks at 4 Hz	Off	-	-	-	-	-	-
The device is being located.	Off	Blinks at 4 Hz	Off	Blinks at 4 Hz	Off	Blinks at 4 Hz	Off	Blinks at 4 Hz
The Reset button is being pressed for less than 5 seconds (system reboot)	Off	Blinks at 1 Hz	-	-	-	-	-	-
The Reset button is being pressed for 5 to 10 seconds (System factory reset)	Off	Blinks at 4 Hz	-	-	-	-	-	-
The Reset button is being pressed for longer than 10 seconds (Abort reboot or reset)	Off	Solid on	-	-	-	-	-	-

Event Indicators (enabled Mesh Mode)

Applicable Role		Mesh Portal						Mesh Node					
LED		2.4 GHz		5 GHz		SYS		2.4 GHz		5 GHz		SYS	
Color		Green	Amber	Green	Amber	Green	Red	Green	Amber	Green	Amber	Green	Red
Failed to join mesh network, dismissed upon joining		-	-	-	-	-	-	-	-	-	-	-	Blinks at 4 Hz
Mesh backhaul													
Data transmission	Normal	-	-	Blinks	-	-	-	-	-	-	-	-	-
	Indicating signal-to-noise ratio	-	-	-	-	-	-	-	-	SNR ≥ 35	SNR < 35	-	-
AP/Master (VAP)													
When data transmission	Blinks	-	-	-	-	-	-	-	-	-	-	-	-
	-	-	-	-	-	-	-	Blinks	-	-	-	-	-

Beeper

The beeper emits two short beeps when the system is ready.

Reset Button

Depending on the AWK Series model, the Reset is located on the side panel (AWK-4252A), top panel (AWK-3252A), or bottom panel (AWK-1151C). You can reboot the AWK series or reset it to factory default settings by pressing the **RESET** button with a pointed object such as an unfolded paper clip.

- **System reboot:** Hold down the Reset button for under 5 seconds and then release. The SYS LED will blink at 1 Hz.
- **Reset to factory default:** Hold down the Reset button for over 5 seconds until the SYS LED starts blinking green. Release the button to reset the AWK Series to its factory default settings. The SYS LED will blink at 4 Hz.
- **Abort the action:** Hold the Reset button down for longer than 10 seconds and then release to abort the reset action. The SYS LED will stop blinking and turn solid.



NOTE

The reset to default factory settings function of the reset button is disabled by default and must be enabled in the web console. Refer to the [Reset Button Active Duration](#) section for more detailed information.

Relay (AWK-3252A and AWK-4252A Only)

The AWK-3252A and AWK-4252A Series have one relay output which is used to forward system failures and user-configured events.

The two wires attached to the relay contacts form an open circuit when a user-configured event is triggered.

If a user-configured event does not occur, the relay circuit will remain closed. For safety reasons, the relay circuit is kept open when the device is not powered on.

Summary of the AWK-3252A's Relay Status

Power Status	Event	Relay
Off	-	Open
On	Yes	Open
	No	Closed

The AWK-3252A relay is marked on the 2 terminal block contacts, as shown in the image below:

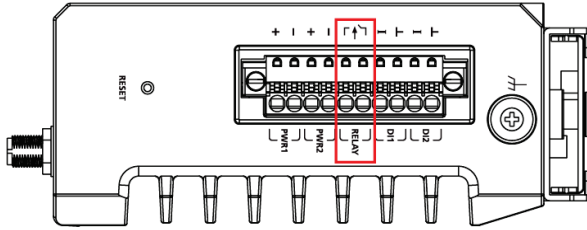

The AWK-4252A relay is integrated into the DI/DO connector (pins 1 and 2), as shown in the image below:

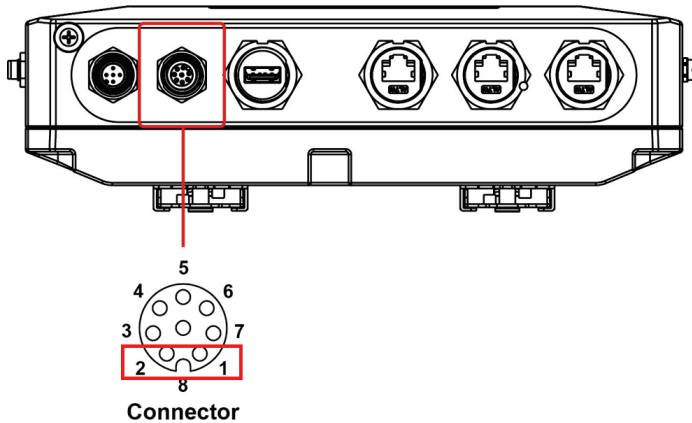

First-time Installation and Configuration

Before installing the AWK Series, make sure that all items in the Package Checklist listed in the Quick Installation Guide are in the box. You will need access to a notebook computer or PC equipped with an Ethernet port.



NOTE

The images in the instructions below use the AWK-3252A Series interface for reference. The instructions are identical for all supported AWK models.

Step 1: Select the power source.

The AWK Series can be powered by a DC power input or PoE (Power over Ethernet) if applicable.



NOTE

For PoE-capable models, when both a DC and PoE power source is connected, the DC input will be the default primary power source while PoE will be secondary. Using both DC and PoE power sources at the same time does not provide seamless power redundancy. In the event the DC power source goes down, the AWK will perform a reboot to negotiate the PoE protocol before switching to the PoE source.

Step 2: Connect the AWK Series to a notebook or PC.

Since the AWK Series supports MDI/MDI-X auto-sensing, you can use either a straight-through or crossover cable to connect the AWK Series to the computer. The LED indicator on the AWK Series' LAN port will light up when a connection is established.

Step 3: Set up the computer's IP address.

Choose an IP address on the same subnet as the AWK Series. Since the AWK Series' default IP address is **192.168.127.253**, and the subnet mask is **255.255.255.0**, you should set the IP address of the computer to **192.168.127.xxx**.

Step 4: Access the homepage of the AWK.

Open your computer's web browser and type **https://192.168.127.253** in the address field to access the AWK's homepage. If successfully connected, the AWK's interface homepage will appear. Click **NEXT**.



Step 5: Choose your country or region. (Not applicable to -US models)

Select your country or region from the drop-down list and click **NEXT**.

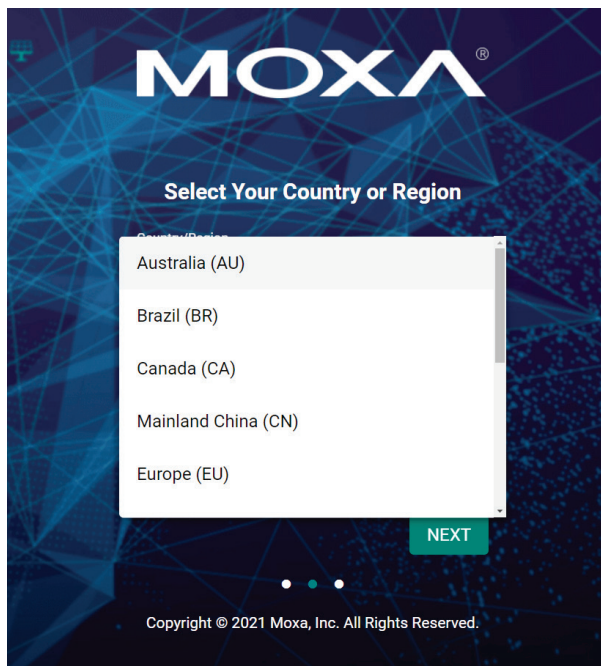

Step 6: Create a user account and password.

There is no default user account and password. Enter the username, password, and email address for your user account and click **CREATE**.



NOTE

The username and password are case-sensitive.

The screenshot shows the Moxa administrator account creation interface. At the top, the Moxa logo is displayed. Below it, the heading 'Create your administrator account' is centered. The form consists of four input fields: 'Username *' with a character count of '0 / 32' and a note 'At least 4 characters'; 'New Password *' with a character count of '0 / 63', a strength indicator icon, and a note 'At least 4 characters'; 'Confirm Password *' with a character count of '0 / 63', a strength indicator icon, and a note 'At least 4 characters'; and 'Email' with a character count of '0 / 318'. At the bottom of the form are two buttons: 'BACK' and 'CREATE'. Below the buttons are three dots and a copyright notice: 'Copyright © 2021 Moxa, Inc. All Rights Reserved.'

After creating your account, you will be automatically redirected to the login screen.

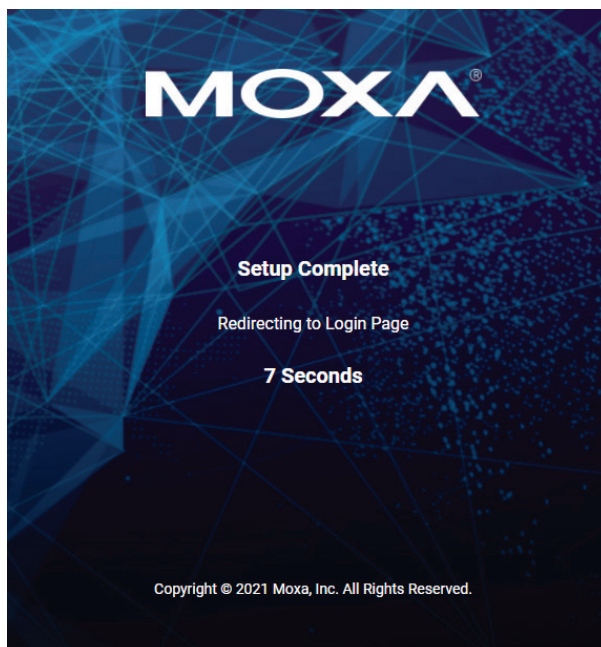

Step 7: Log in to the device.

Once the initialization message disappears (in red), enter your username and password and click **LOG IN**.



Communication Testing

After installing the AWK Series you can run a sample test to make sure the AWK Series and the wireless connection are functioning normally. Two testing methods are described below. Use the first method if you are using only one AWK Series device as an AP and use the second method if you are using AWK Series devices as Client and AP.

How to Test the AWK Series as an AP

AWK-3252A/AWK-4252A

If you are testing the AWK Series device as an AP, you will need a second notebook computer equipped with a WLAN card. Configure the WLAN card to connect to the AWK Series and change the IP address of the second notebook (Notebook B) so that it is on the same subnet as the first notebook (Notebook A), which is connected to the AWK Series.

After configuring the WLAN card, establish a wireless connection with the AWK Series and open a DOS window on Notebook B. At the prompt, type

ping <IP address of notebook A>

and then press **Enter** (see the figure below). A "Reply from IP address ..." response means the communication was successful. A "Request timed out." response means the communication failed. In this case, recheck the configuration to make sure the connections are correct.

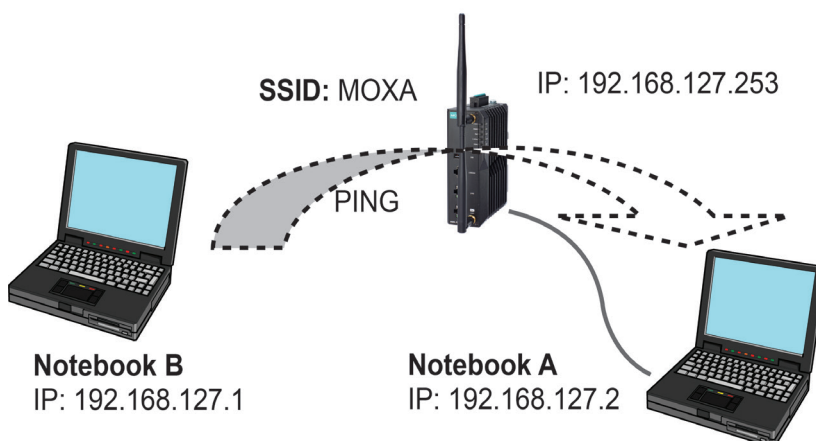

How to Test the AWK Series as a Client

AWK-3252A/AWK-4252A/AWK-1151C

If you are testing the AWK Series as a Client, you will need a second notebook computer (Notebook B) equipped with an Ethernet port as well as an AP connected to notebook A. Configure the AWK Series connected to notebook B for Client mode with the correct SSID and credentials matching the target AP.

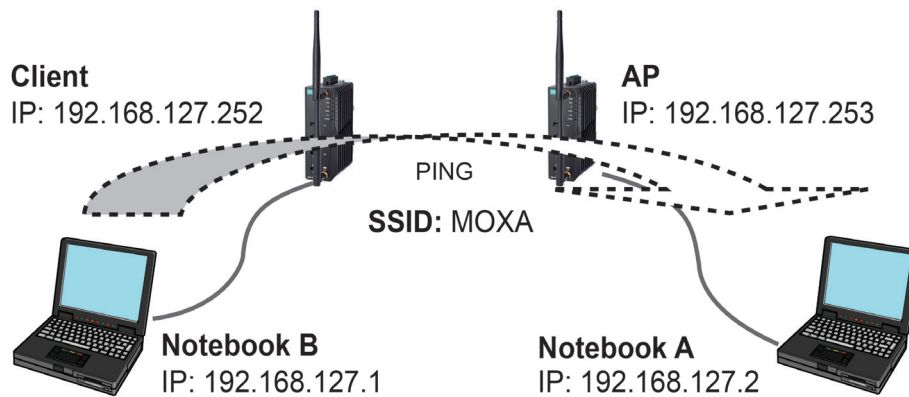

After setting up the testing environment, open a DOS window on notebook B. At the prompt, type:

```
ping <IP address of notebook A>
```

and then press **Enter**. A "Reply from IP address ..." response means the communication was successful. A "Request timed out" response means the communication failed. In this case, recheck the configuration to make sure the connections are correct.

3. Web Interface Configuration

Moxa's AWK Series offers a user-friendly web interface for easy configuration. All functions of the Moxa's AWK Series can be configured via this web interface.

Function Introduction

This section describes the web interface design, providing a basic visual concept for users to understand the main information or configuration menu for the web interface pages.

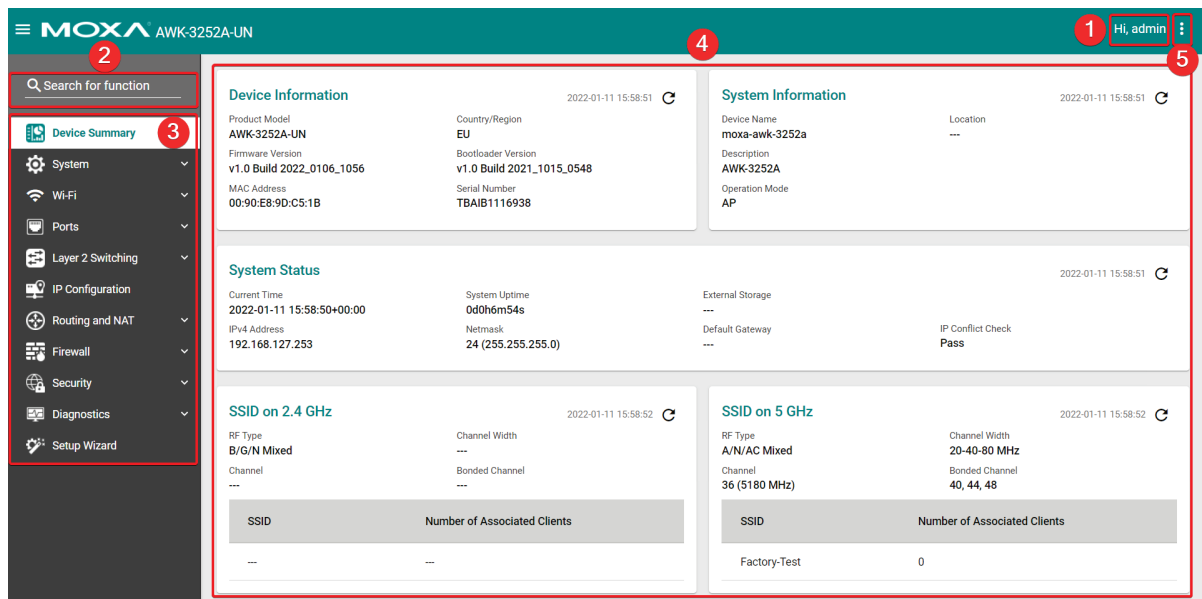

1. **Login Name:** This shows the name of the user that is currently logged in.
2. **Search Bar:** Type the name of the function you want to search for in the function menu tree.
3. **Function Menu:** All functions of the AWK Series are shown here. Click the function you want to view or configure.
4. **Device Summary:** All important device information and statistics are shown here.
5. **Maintenance:** Functions for device maintenance are located here.

Device Summary

After successfully connecting to the AWK Series, the **Device Summary** will automatically appear. To view the device summary from anywhere in the interface, click **Device Summary** on the Function Menu.

The screenshot displays a dashboard with five main widgets:

- Device Information** (2022-01-11 14:17:45):
 - Product Model: AWK-3252A-UN
 - Country/Region: EU
 - Firmware Version: v1.0 Build 2022_0106_1056
 - MAC Address: 00:90:E8:9D:C5:31
 - Bootloader Version: v1.0 Build 2021_1214_0620
 - Serial Number: TBAIB1116960
- System Information** (2022-01-11 14:17:45):
 - Device Name: moxa-awk-3252a
 - Location: ---
 - Description: AWK-3252A
 - Operation Mode: AP
- System Status** (2022-01-11 14:17:45):
 - Current Time: 2022-01-11 14:17:44+00:00
 - System Uptime: 0d0h7m31s
 - External Storage: ---
 - Default Gateway: ---
 - IP Conflict Check: Pass
 - IPv4 Address: 192.168.127.253
 - Netmask: 24 (255.255.255.0)
- SSID on 2.4 GHz** (2022-01-11 14:17:35):
 - RF Type: B/G/N Mixed
 - Channel Width: ---
 - Channel: ---
 - Bonded Channel: ---
 - Table: SSID vs Number of Associated Clients (empty)
- SSID on 5 GHz** (2022-01-11 14:17:35):
 - RF Type: A/N/AC Mixed
 - Channel Width: 20-40-80 MHz
 - Channel: 36 (5180 MHz)
 - Bonded Channel: 40, 44, 48
 - Table: SSID vs Number of Associated Clients (empty)

See the following sections for a detailed description of each widget.

Device Information

This shows the model information, including product model name, the country or region where the device is located, and firmware version.

Device Information 2022-01-11 11:44:38

Product Model	Country/Region
AWK-3252A-UN	EU
Firmware Version	Bootloader Version
v1.0 Build 2022_0106_1056	v1.0 Build 2021_1015_0548
MAC Address	Serial Number
00:90:E8:9D:C5:33	TBAIB1116962

System Information

This shows system information including the device name, location, description, and current operation mode.

System Information 2021-09-23 10:02:07

Device Name	Location
moxa-awk-3252a	---
Description	
AWK-3252A	
Operation Mode	
AP	

System Status

This shows the system status, including system time, system uptime, and IP address.

System Status			2021-09-23 10:02:27
Current Time	System Uptime	External Storage	
2021-09-23 10:02:25+00:00	5d16h15m26s	---	
IPv4 Address	Netmask	Default Gateway	IP Conflict Check
192.168.0.222	24 (255.255.255.0)	---	Pass

SSID

This shows information for the SSIDs configured on the AWK Series. This widget includes both the 2.4 GHz and 5 GHz bands.

SSID on 2.4 GHz		2022-08-25 15:51:45
RF Type	Channel Width	
B/G/N Mixed	20-40 MHz	
Channel	Bonded Channel	
6 (2437 MHz)	---	
SSID	Number of Associated Clients	
Moxa-2G	0	

SSID on 5 GHz		2022-08-25 15:51:15
RF Type	Channel Width	
N/AC Mixed	20-40-80 MHz	
Channel	Bonded Channel	
36 (5180 MHz)	40, 44, 48	
SSID	Number of Associated Clients	
Moxa-5G	0	

System

The **System** section houses all device and system configuration functions. From here, you can configure the **System Management**, **Account Management**, **Management Interface**, and **Time** settings.

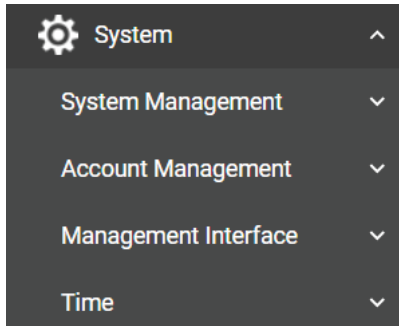

System Management

The **System Management** section houses three subsections: **System Information**, **Firmware Upgrade**, and **Configure Backup and Restore**.

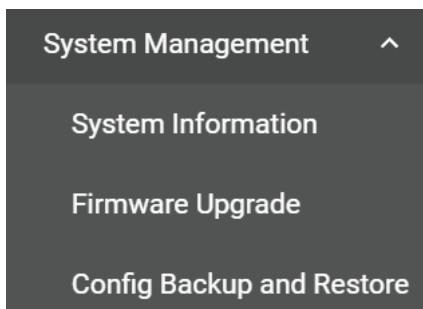

System Information

On the **System Information** screen, you can enter a device name, description, and location for the device. This makes it easier to identify different AWKs that are connected to your network.

System Information

Device Name *

moxa-awk-3252a 14 / 255

Location

0 / 255

Description

AWK-3252A 9 / 255

Contact Information

0 / 255

Device Name

Setting	Description	Factory Default
1 to 255 characters	<p>Enter a name for the device. This is useful for differentiating between the roles or applications of different units. Note that the device name cannot be empty and must comply with the following naming rules:</p> <ul style="list-style-type: none"> • Only supports letters (a-z), numbers (0-9), and special character dash (-) • Cannot contain spaces • Cannot start with dash (-) • Cannot end with dash (-) • When used in a PROFINET environment, cannot start with the prefix "port-x" where "x" equals 0 to 9. There is no validity to identify incorrect name formats. 	moxa-awk-3252a

Location

Setting	Description	Factory Default
Max. 255 characters	Enter a location for the device. This is useful for identifying where the device is deployed. Example: production line 1.	None

Description

Setting	Description	Factory Default
Max. 255 characters	Enter a description for the device.	AWK-3252A

Contact Information

Setting	Description	Factory Default
Max. 255 characters	Enter the contact information of the person responsible for the device in case there is a problem with the device.	None

When finished, click **APPLY** to save your changes.

Firmware Upgrade

There are four ways to update your AWK's device firmware: from a local *.rom file, by remote TFTP server, remote SFTP server, or the ABC-02 tool.

Firmware Upgrade

Running Firmware Version
v1.0 Build 2021_0810_0019

Uploaded Firmware Version

Source *
Local

Select File * 

Local

Select **Local** from the Source drop-down list. Before performing the firmware upgrade, download the target firmware (*.rom) file first from Moxa's website (www.moxa.com) to the local host.

Firmware Upgrade

Running Firmware Version
v1.0 Build 2021_1028_0626

Uploaded Firmware Version

Source *
Local

Select File * 

Running Firmware Version

Setting	Description	Factory Default
Current firmware version number	This shows the current running firmware version.	Current running version

Uploaded Firmware Version

Setting	Description	Factory Default
New firmware version number	This shows the new firmware version.	None

Select File

Setting	Description	Factory Default
Select the firmware file	Click the browse icon and navigate to the firmware file on the local host.	None

When finished, click **UPLOAD** to upload the file, then click **UPGRADE** to perform the firmware upgrade.

TFTP Server

Select **TFTP** from the Source drop-down list.

Firmware Upgrade

TFTP does not support user authentication and sends all data in clear text. We recommend using SFTP to transfer firmware.

Running Firmware Version
v1.0 Build 2021_0927_0419

Uploaded Firmware Version

Source
TFTP

Server IP Address * 0 / 253 Filename * 0 / 256

Running Firmware Version

Setting	Description	Factory Default
Current firmware version number	This shows the current running firmware version.	Current running version

Uploaded Firmware Version

Setting	Description	Factory Default
New firmware version number	This shows the new firmware version.	None

Server IP Address

Setting	Description	Factory Default
TFTP server address	Enter the IP address of the TFTP server where the new firmware file (*.rom) is located.	None

File Name

Setting	Description	Factory Default
Firmware file name	Enter the file name of the new firmware.	None

When finished, click **UPLOAD** to upload the file, then click **UPGRADE** to perform the firmware upgrade.

SFTP

Select **SFTP** from the Source drop-down list.

Firmware Upgrade

Running Firmware Version
v1.0 Build 2021_0927_0419

Uploaded Firmware Version

Source *
SFTP

Server IP Address * 0 / 253 Filename * 0 / 256

Account * 0 / 256 Password * 0 / 256

Running Firmware Version

Setting	Description	Factory Default
Current firmware version number	This shows the current running firmware version.	Current running version

Uploaded Firmware Version

Setting	Description	Factory Default
New firmware version number	This shows the new firmware version.	None

Server IP Address

Setting	Description	Factory Default
SFTP server address	Enter the IP address of the SFTP server where the new firmware file (*.rom) is located.	None

File Name

Setting	Description	Factory Default
Firmware file name	Enter the file name of the new firmware.	None

Account

Setting	Description	Factory Default
SFTP server account	Enter the SFTP user account name. This account must be authorized to ensure a secure connection to the SFTP server.	None

Password

Setting	Description	Factory Default
SFTP server password	Enter the SFTP user account password. This account must be authorized to ensure a secure connection to the SFTP server.	None

When finished, click **UPLOAD** to upload the file, then click **UPGRADE** to perform the firmware upgrade.

ABC-02

Select **ABC-02** from the Source drop-down. This method requires the Moxa ABC-02 USB configuration backup and restoration tool with the target firmware file is connected to the device. You can download the target firmware (*.rom) file from Moxa's website (www.moxa.com). For more information about the Moxa ABC-02 Series USB tool, visit the [product page](#).

Firmware Upgrade

Running Firmware Version
v1.0 Build 2021_0810_0019

Uploaded Firmware Version

Source *
ABC-02

Select File * 

Running Firmware Version

Setting	Description	Factory Default
Current firmware version number	This shows the current running firmware version.	Current running version

Uploaded Firmware Version

Setting	Description	Factory Default
New firmware version number	This shows the new firmware version.	None

Select File

Setting	Description	Factory Default
Select the firmware file	Click the browse icon and navigate to the firmware file on the attached ABC-02 device.	None

When finished, click **UPLOAD** to upload the file, then click **UPGRADE** to perform the firmware upgrade.

Configuration Backup and Restore

There are four ways to back up and restore your Moxa AWK's configuration: from a local configuration file, by remote TFTP server, remote SFTP server, or an ABC-02 USB backup and restoration tool.

Backup

The **Backup** tab is used to export a backup of the current configuration. This backup file can then be used to restore the device's configuration settings, or to import it to other AWK Series devices.

The screenshot shows the 'Configuration Backup and Restore' interface with the 'Backup' tab selected. The 'Configuration Source' dropdown is set to 'Running Configuration', and the 'Storage Location' dropdown is set to 'Local'. The 'Configuration Password' field is empty, with a character count of '0 / 64'. A 'BACK UP' button is located at the bottom left of the form.

Local

Select **Local** first from the Storage Location drop-down list.

This screenshot is identical to the one above, showing the 'Configuration Backup and Restore' interface with the 'Backup' tab selected. The 'Configuration Source' is 'Running Configuration', 'Storage Location' is 'Local', and the 'Configuration Password' field is empty with a '0 / 64' character count. The 'BACK UP' button is present at the bottom left.

Configuration Source

Setting	Description	Factory Default
Running Configuration	Back up the running configuration.	Running
Startup Configuration	Back up the start-up configuration.	Configuration

Storage Location

Setting	Description	Factory Default
Local	Back up the configuration files for the local computer.	Local
TFTP	Back up the configuration files via TFTP.	
SFTP	Back up the configuration files via SFTP.	
ABC-02	Back up the configuration files via ABC-02 USB tool.	

Configuration Password

Setting	Description	Factory Default
Configuration password	Enter the configuration password. You will need to enter this password when importing the backup file. For firmware v2.0 and above, the password must be at least 8 characters long.	None

When finished, click **BACK UP**.

TFTP Server

Select **TFTP** first from the Storage Location drop-down list.

Configuration Backup and Restore

Backup
Restore

TFTP does not support user authentication and sends all data in clear text. We recommend using SFTP to back up the configuration files.

Configuration Source *

Running Configuration ▼

Storage Location *

TFTP ▼

Server IP Address * 0 / 253

Filename * 0 / 256

Configuration Password * 0 / 64

BACK UP

Configuration Source

Setting	Description	Factory Default
Running Configuration	Back up the running configuration.	Running
Startup Configuration	Back up the start-up configuration.	Configuration

Storage Location

Setting	Description	Factory Default
Local	Back up the configuration files for the local computer.	Local
TFTP	Back up the configuration files via TFTP.	
SFTP	Back up the configuration files via SFTP.	
ABC-02	Back up the configuration files via ABC-02 USB tool	

Server IP Address

Setting	Description	Factory Default
TFTP server address	Enter the IP address of the TFTP server.	None

File Name

Setting	Description	Factory Default
Max. 256 characters (including the .ini file extension).	Enter the configuration backup file name.	None

Configuration Password

Setting	Description	Factory Default
Configuration password	Enter the configuration password. You will need to enter this password when importing the backup file.	None

When finished, click **BACK UP**.

SFTP Server

Select **SFTP** first from the Storage Location drop-down list.

Configuration Backup and Restore

Backup
Restore

Configuration Source *

Running Configuration ▼

Storage Location

SFTP ▼

Server IP Address *

0 / 253

Filename *

0 / 256

Account *

0 / 256

Password *

0 / 256

Configuration Password *

0 / 64

BACK UP

Configuration Source

Setting	Description	Factory Default
Running Configuration	Back up the running configuration.	Running
Startup Configuration	Back up the start-up configuration.	Configuration

Storage Location

Setting	Description	Factory Default
Local	Back up the configuration files for the local computer.	Local
TFTP	Back up the configuration files via TFTP.	
SFTP	Back up the configuration files via SFTP.	
ABC-02	Back up the configuration files via ABC-02 USB tool	

Server IP Address

Setting	Description	Factory Default
SFTP server address	Enter the IP address of the SFTP server where the new firmware file (*.rom) is located.	None

File Name

Setting	Description	Factory Default
Max. 256 characters (including the .ini file extension).	Enter the configuration backup file name.	None

Account

Setting	Description	Factory Default
SFTP server account	Enter the SFTP user account name. This account must be authorized to ensure a secure connection to the SFTP server.	None

Password

Setting	Description	Factory Default
SFTP server password	Enter the SFTP user account password. This account must be authorized to ensure a secure connection to the SFTP server.	None

Configuration Password

Setting	Description	Factory Default
Configuration password	Enter the configuration password. You will need to enter this password when importing the backup file.	None

When finished, click **BACK UP**.

ABC-02

Select **ABC-02** from the Storage Location drop-down list. This method requires a Moxa ABC-02 configuration backup and restore USB tool to be connected to the AWK Series.

Configuration Backup and Restore

Backup Restore

Configuration Source *
Running Configuration

Storage Location *
ABC-02

Backup for System Initialization *
No

Select Folder * 

Configuration Password * 
0 / 64

BACK UP

Configuration Source

Setting	Description	Factory Default
Running Configuration	Back up the running configuration.	Running
Startup Configuration	Back up the start-up configuration.	Configuration

Storage Location

Setting	Description	Factory Default
Local	Back up the configuration files for the local computer.	Local
TFTP	Back up the configuration files via TFTP.	
SFTP	Back up the configuration files via SFTP.	
ABC-02	Back up the configuration files via ABC-02 USB tool.	

Backup for System Initialization

Setting	Description	Factory Default
Yes	Back up the system initialization files.	No
No	Do not back up the system initialization files.	

Select Folder

Setting	Description	Factory Default
Folder path	Navigate to the folder path of the ABC-02 tool.	None

Configuration Password

Setting	Description	Factory Default
Configuration password	Enter the configuration password. You will need to enter this password when importing the backup file.	None

When finished, click **BACK UP**.

Automatic Backup to ABC-02

The AWK-Series also supports automatic configuration backups when using a Moxa ABC-02 backup and restore tool.

Automatically Back Up Configurations to ABC-02

Auto Backup Status *

Disabled ▼

APPLY

Auto Backup Status

Setting	Description	Factory Default
Enabled/Disabled	Enable or disable automatically backing up the device's configuration to the ABC-02.	Disabled

When finished, click **APPLY**.

Restore

From the **Restore** tab you restore the device's configuration using a previously created backup file.

Configuration Backup and Restore

Backup **Restore**

Source *

Local ▼

Select File * 

Configuration Password *  0 / 64

RESTORE

Local

Source

Setting	Description	Factory Default
Local	Restore the configuration from a local backup file.	Local
TFTP	Restore the configuration from a backup file via TFTP.	
SFTP	Restore the configuration from a backup file via SFTP.	
ABC-02	Restore the configuration from a backup file on an ABC-02 USB tool.	

Select File

Setting	Description	Factory Default
Backup file	Click the browse icon and navigate to the backup file on the local host.	None

Configuration Password

Setting	Description	Factory Default
Configuration password	Enter the configuration password. You will need to enter this password when importing the backup file.	None

When finished, click **RESTORE**.

TFTP Server

Configuration Backup and Restore

Backup **Restore**

TFTP does not support user authentication and sends all data in clear text. We recommend using SFTP to restore the configuration files.

Source
TFTP

Server IP Address * Filename *
0 / 253 0 / 256

Configuration Password * 
0 / 64

RESTORE

Source

Setting	Description	Factory Default
Local	Restore the configuration from a local backup file.	Local
TFTP	Restore the configuration from a backup file via TFTP.	
SFTP	Restore the configuration from a backup file via SFTP.	
ABC-02	Restore the configuration from a backup file on an ABC-02 USB tool.	

Server IP Address

Setting	Description	Factory Default
TFTP server address	Enter the IP address of the TFTP server.	None

File Name

Setting	Description	Factory Default
Max. 256 characters (including the .ini file extension)	Enter the file name of the configuration backup file.	None

Configuration Password

Setting	Description	Factory Default
Configuration password	Enter the configuration password. You will need to enter this password when importing the backup file.	None

When finished, click **RESTORE**.

SFTP Server

Configuration Backup and Restore

Backup Restore

Source *
SFTP

Server IP Address * Filename *
0 / 253 0 / 256

Account * Password *
0 / 256 0 / 256

Configuration Password *
0 / 64

RESTORE

Source

Setting	Description	Factory Default
Local	Restore the configuration from a local backup file.	Local
TFTP	Restore the configuration from a backup file via TFTP.	
SFTP	Restore the configuration from a backup file via SFTP.	
ABC-02	Restore the configuration from a backup file on an ABC-02 USB tool.	

Server IP Address

Setting	Description	Factory Default
SFTP server address	Enter the IP address of the SFTP server where the new firmware file (*.rom) is located.	None

File Name

Setting	Description	Factory Default
Max. 256 characters (including the .ini file extension).	Enter the filename of the configuration restoration file.	None

Account

Setting	Description	Factory Default
SFTP server account	Enter the SFTP user account name. This account must be authorized to ensure a secure connection to the SFTP server.	None

Password

Setting	Description	Factory Default
SFTP server password	Enter the SFTP user account password. This account must be authorized to ensure a secure connection to the SFTP server.	None

Configuration Password

Setting	Description	Factory Default
Configuration password	Enter the configuration password. You will need to enter this password when importing the backup file.	None

When finished, click **RESTORE**.

ABC-02

Configuration Backup and Restore

Backup **Restore**

Source

ABC-02

Select File *



Configuration Password *

 0 / 64

RESTORE

Source

Setting	Description	Factory Default
Local	Restore the configuration from a local backup file.	Local
TFTP	Restore the configuration from a backup file via TFTP.	
SFTP	Restore the configuration from a backup file via SFTP.	
ABC-02	Restore the configuration from a backup file on an ABC-02 USB tool.	

Select File

Setting	Description	Factory Default
Backup file	Click the browse icon and navigate to the backup file on the local host.	None

Configuration Password

Setting	Description	Factory Default
Configuration password	Enter the configuration password. You will need to enter this password when importing the backup file.	None

When finished, click **RESTORE**.

Automatic Restoration to ABC-02

The AWK Series supports automatic configuration restoration when using a Moxa ABC-02 backup and restore tool.

Automatically Restore Configurations from ABC-02

Auto Restore Status *

Disabled

APPLY

Auto Restore Status

Setting	Description	Factory Default
Enabled/Disabled	Enable or disable automatically restoring the device's configuration from an ABC-02.	Disabled

When finished, click **APPLY** to change your setting.

Fast Boot-up

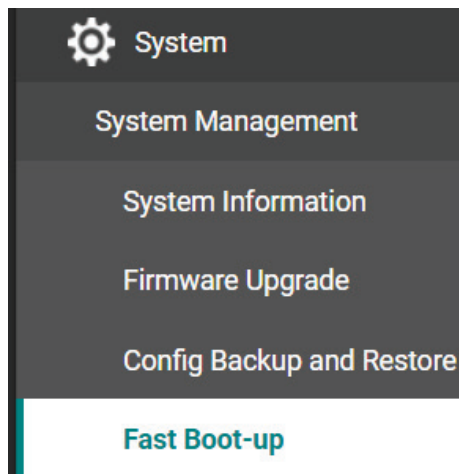

The AWK series is designed with comprehensive security mechanisms to verify device integrity during boot up. These security measures take time to execute before the system is fully functional and wireless connectivity services become available. For applications that requires fast connectivity services from cold boot, 'Fast Boot-up' (default Disabled) is an optional feature that omits the configuration file regeneration process—including verification of configuration files—to shorten the overall boot up time by approximately 30 seconds.

Be aware that omitting the configuration file regeneration process means that the device will be running configuration file saved to eMMC without verification. This could pose a security risk if the device has been physically accessed and eMMC storage tampered with.

Fast Boot-up

Status *

Disabled

APPLY

If enabled, the configuration will not be regenerated when the device boots up and may pose a potential security concern.

Status

Setting	Description	Factory Default
Enabled/Disabled	To enable or disable the fast boot-up function.	Disabled



NOTE

- This option will not shorten boot times in some cases, such as: Configuration file not saved after changes
- Importing configurations
- Upgrading firmware



ATTENTION

Enabling this feature may pose security risks! Read the above section carefully and make sure you understand the risks before proceeding.

Account Management

From this section, you can manage User Account settings and the Password Policy.

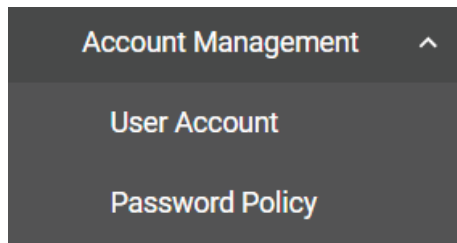

User Account

The **User Account** section lets you manage user accounts on the device, including setting user roles and privileges. Click **User Account** under **Account Management** to access this configuration screen.

Create a New Account

To create a new user account, click the **Settings** tab, then click the Add  icon.

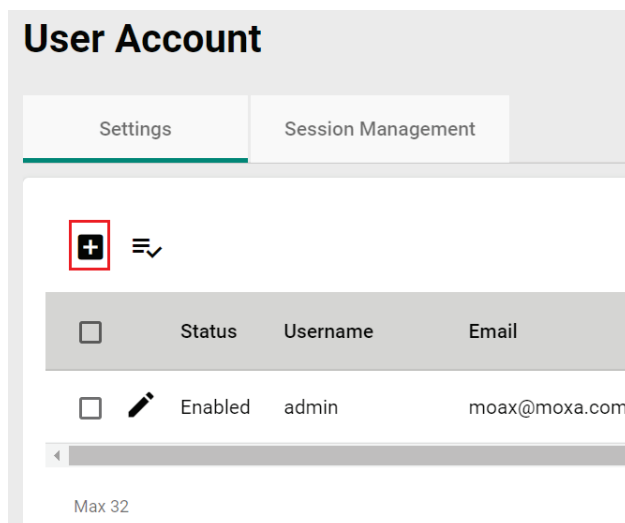

Edit the following settings:

Create New Account

Status *
Disabled ▼

Username *
At least 4 characters 0 / 32

New Password * Confirm Password *
At least 4 characters 0 / 63 At least 4 characters 0 / 63

Email
 0 / 318

Role *
User ▼

Authority *

- Account System
- Advanced Diagnostics
- Auditor System
- Diagnostics
- Network Configuration
- Status Monitoring
- System Backup
- System Management

CANCEL
APPLY

Status

Setting	Description	Factory Default
Enabled/Disabled	Enable or disable the user account.	Disabled

Username

Setting	Description	Factory Default
Min. 4 characters	Enter a username for this account.	None

New Password

Setting	Description	Factory Default
Min. 8 characters	Enter the password for this account. For better protection, it is recommended to enforce stronger password complexity by enabling the following Password Policy requirements: At least one digit (0-9) At least one upper case letter (A-Z) At least one lower case letter (a-z) At least one special character (~!@#\$%^&*-_!;,:<>{}[]())	None

Confirm Password

Setting	Description	Factory Default
Password	Enter the account password again for confirmation.	None

Email

Setting	Description	Factory Default
Email	Enter the email address for this account.	None

Role

Setting	Description	Factory Default
Administrator	Set the user's role to Administrator. This role provides full access to all configurations on the device. (pre-defined authority)	User
Engineer	Set the user's role to Engineer. (pre-defined authority)	
User	Set the user's role to User. (pre-defined authority)	
Custom	If a mix of authorities is necessary, create an account via the Custom option and manually select the necessary authorities for this account.	

Authority

Setting	Description	Factory Default
Checkbox	Checking authorities gives the user the ability to access configurations pages in the corresponding category. These authority privileges extend to all access interfaces, including CLI.	None

Refer to the table below for an overview of each role and corresponding authorities.

Authority	Admin	Engineer	User
Account System	Yes	No	No
Advanced Diagnostic	Yes	Yes	No
Auditor System	Yes	Yes	No
Diagnostic	Yes	Yes	Yes
Network	Yes	Yes	No
Status Monitoring	Yes	Yes	Yes
System Backup	Yes	No	No
System Management	Yes	Yes	No



NOTE

The Administrator, Engineer, and User roles have pre-defined authority options and cannot be changed. The Administrator has all authorities enabled by default. The Custom role allows you to select specific authorities for the user account.

Refer to Appendix D for a detailed overview of the required authority for each device feature or service to determine the privilege requirements when setting up an account.

When finished, click **APPLY** to create a new account.

Edit an Existing Account

Click the Edit icon  of the account you want to edit.

<input type="checkbox"/>	Status	Username	Email	Role	Account System	Advanced Diagnostics	Auditor System	Diagnostics	Network Configuration	Status Monitoring	System Backup	System Management
<input type="checkbox"/>	Enabled	admin	moxa@moxa.com	Administrator	✓	✓	✓	✓	✓	✓	✓	✓
<input type="checkbox"/>	Enabled	test	test@example.com	User				✓		✓		



Items per page: 20 1 - 2 of 2 < > >>

Edit the account settings. Refer to **Create a New Account** for a description of each setting.

Edit Account

Status *
Enabled

Username
test

New Password  0 / 63 Confirm Password  0 / 63

Email
test@example.com 16 / 318

Role *
User

Authority *



- Account System
- Advanced Diagnostics
- Auditor System
- Diagnostics
- Network Configuration
- Status Monitoring
- System Backup
- System Management

CANCEL **APPLY**

When finished, click **APPLY**.

Delete an Existing User

To delete one or more existing users, check the user(s) you want to delete and click the **Delete**  icon on the top of the page.

	Status	Username	Email	Role
<input type="checkbox"/> 	Enabled	admin	moxa@moxa.com	Administrator
<input checked="" type="checkbox"/> 	Enabled	test	test@example.com	User

Delete Account

Are you sure you want to delete the selected account?

CANCEL

DELETE



Click **DELETE** to delete the user.

Terminate the Active Session of a User

If necessary, you can manually terminate a specific user's active session for a specific interface. This will also record an event log.

Click **Session Management** tab and click the **Terminate Session**  icon next to the user.

User Account

General		Session Management		
Username	WEB: Status	WEB: Last Login	WEB: Last Activity	
 admin	In Use	2021-08-25 00:38:22+00:00	2021-08-25 00:38:42+00:00	
 test	In Use	2021-08-25 00:38:11+00:00	2021-08-25 00:38:12+00:00	

Max 32

When prompted, select which active sessions you want to terminate.

Terminate Session

Which active session(s) do you want to terminate?

WEB

CLI

MXconfig

CANCEL
TERMINATE

Click **TERMINATE** to end the selected sessions. The user will be logged out of the corresponding interfaces immediately.

Edit the Password Policy

To edit the password policy, click **Password Policy** under **Account Management** in the function menu tree.

Password Policy

Minimum Length *

8

8 - 63

Password Validation Rules

Must include at least one digit (0-9)

Must include at least one uppercase letter (A-Z)

Must include at least one lowercase letter (a-z)

Must include at least one special character (~!@#\$%^&*-_!;,:.<>{}[]())

Password Lifetime *

90

0 - 365 day(s)

APPLY

Minimum Length

Setting	Description	Factory Default
8 to 63	Specify the required user account password length based on your organization's password length policy. To comply with IEC 62443 requirements, the minimum length starts at 8.	8

Password Validation Rules

Setting	Description	Factory Default
Selectable checkboxes	Select check box to enforce the required password complexity: At least one digit (0-9) At least one upper case letter (A-Z) At least one lower case letter (a-z) At least one special character (~!@#\$%^&*-_!;,:.<>{}[]())	Unchecked

Password Lifetime

Setting	Description	Factory Default
0 to 365 day(s)	Specify the maximum password lifetime. At the end of this duration, the password will expire, and users will be requested to create a new password.	90

When finished, click **APPLY**.

Management Interface

The **Management Interface** section houses the **User Interface**, **Hardware Interface**, and **SNMP configuration** screens.

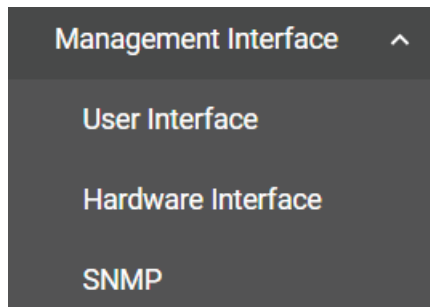

User Interface

The **User Interface** configuration screen lets you manage the interfaces available to users to access the device. Click **User Interface** under **Management Interface** to access this screen.

User Interface

HTTP and Telnet are not secure interface. We recommend disabling these.

HTTP Status *	HTTP: TCP Port *
Enabled	80
	1 - 65535
HTTPS Status *	HTTPS - TCP Port *
Disabled	443
	1 - 65535
Telnet Status *	Telnet - TCP Port *
Disabled	23
	1 - 65535
SSH Status *	SSH - TCP Port *
Enabled	22
	1 - 65535
SNMP Status *	SNMP - UDP Port *
Disabled	161
	1 - 65535
Moxa Service Status *	Moxa Service - UDP Port
Enabled	40404

Max. number of Login Session For HTTP + HTTPS *

5

1 - 10

Max. number of Login Session for Telnet + SSH + Serial Console *

5

1 - 10

APPLY

HTTP Status

Setting	Description	Factory Default
Enabled/Disabled	Enable or disable HTTP connections.	Disabled



NOTE

If HTTP and HTTPS are both enabled, any HTTP session will automatically redirect to HTTPS.

HTTP – TCP Port

Setting	Description	Factory Default
1 to 65535	Specify the HTTP interface TCP port number.	80

HTTPS Status

Setting	Description	Factory Default
Enabled/Disabled	Enable or disable HTTPS connections.	Enabled

HTTPS – TCP Port

Setting	Description	Factory Default
1 to 65535	Specify the HTTPS interface TCP port number.	443

Telnet Status

Setting	Description	Factory Default
Enabled/Disabled	Enable or disable Telnet connections.	Disabled

Telnet – TCP Port

Setting	Description	Factory Default
1 to 65535	Specify the Telnet interface TCP port number.	23

SSH Status

Setting	Description	Factory Default
Enabled/Disabled	Enable or disable SSH connections.	Enabled

SSH – TCP Port

Setting	Description	Factory Default
1 to 65535	Specify the SSH interface TCP port number.	22

SNMP Status

Setting	Description	Factory Default
Enabled/Disabled	Enable or disable SNMP.	Disabled

SNMP – Port

Setting	Description	Factory Default
1 to 65535	Specify the SNMP UDP port number.	161

Moxa Service Status

Setting	Description	Factory Default
Enabled/Disabled	Enable or disable Moxa Service.	Enabled



NOTE

Moxa Service is only for Moxa network management software such as MXconfig.

Moxa Service (Encrypted)

Setting	Description	Factory Default
40404 (read only)	Specify the Moxa Service UDP port.	40404

Maximum number of Login Sessions for HTTP + HTTPS

Setting	Description	Factory Default
1 to 10	Specify the maximum number of concurrent HTTP+HTTPS login sessions allowed on the device.	5

Maximum number of Login Sessions for Telnet + SSH + Serial Console

Setting	Description	Factory Default
1 to 10	Specify the maximum number of concurrent Telnet, SSH, and Serial login sessions allowed on the device.	5

When finished, click **APPLY**.

Hardware Interface

From the **Hardware Interface** screen, you can manage the physical interfaces on the device. Click **Hardware Interface** under **Management Interface** to access this screen.

Hardware Interface

Reset Button Status *
Disabled

Reset Button Active Duration *
120
0 - 180 sec.

Serial Status *
Enabled

USB Status *
Enabled

APPLY

Configure the following settings:

Reset Button Status

Setting	Description	Factory Default
Enabled/Disabled	Enable or disable the reset button.	Disabled

Reset Button Active Duration

Setting	Description	Factory Default
0 to 180 (sec.)	<p>If the reset button is disabled, the "Active Duration" defines the grace period (in seconds) where the reset button will be active for after a system cold boot up. After the grace period, the reset button will be disabled.</p> <p>Note:</p> <ul style="list-style-type: none">• If set to 0, the reset button will always be disabled.• The Active Duration countdown begins as soon as the RF LED indicator turns from amber to off after the boot up process. Specifically, the 2.4 GHz and 5 GHz LED on the AWK-3252A and AWK-4252A Series; the WLAN LED on the AWK-1151C Series.	120

Serial Status

Setting	Description	Factory Default
Enabled/Disabled	Enable or disable the serial port.	Enabled

USB Status

Setting	Description	Factory Default
Enabled/Disabled	Enable or disable the USB port.	Enabled

When finished, click **APPLY**.

SNMP

The Moxa AWK Series supports SNMP V1, V2c, and V3. SNMP V1 and SNMP V2c use a community string match for authentication, which means that SNMP servers access all objects with read-only or read/write permissions using the default “public” and “private” community strings. SNMP V3 requires MD5 or SHA authentication. You can also enable data encryption to enhance data security.

The supported SNMP security modes and levels are shown in the table below. Select the security mode and level that will be used to communicate between the SNMP agent and manager.

Protocol Version	UI Setting	Authentication	Encryption	Method
SNMP V1, V2c	V1, V2c Read Community	Community string	None	Uses a community string match for authentication.
	V1, V2c Write/Read Community	Community string	None	Uses a community string match for authentication.
SNMP V3	None	None	None	Uses an account with admin or user role to access objects.
	MD5 or SHA	Authentication based on MD5 or SHA	Disabled	Uses authentication based on HMAC-MD5, or HMAC-SHA algorithms. 8-character passwords are the minimum requirement for authentication.
	MD5 or SHA	Authentication based on MD5 or SHA	Data encryption key: DES, AES	Uses authentication based on HMAC-MD5 or HMAC-SHA algorithms, and a data encryption key. 8-character passwords and a data encryption key are the minimum requirements for authentication and encryption.

Configure SNMP Settings

From the **SNMP** screen you can configure the SNMP status and manage the SNMP account. Click **SNMP** from the function tree to access this screen.

SNMP

SNMP
SNMP Account List

SNMP V1 and V2c are not secure. We recommend using SNMP V3.

SNMP Status *
Disabled ▼

APPLY

SNMP Status

Setting	Description	Factory Default
Read/Write	Set SNMP to read-write.	Disabled
Read Only	Set SNMP as read-only.	
Disabled	Disable the SNMP.	

SNMP Version

Setting	Description	Factory Default
V1, V2c, V3	Enable SNMP V1, V2c, and V3.	V3 only
V1, V2c	Enable SNMP V1 and V2c.	
V3 only	Enable SNMP V3 only.	

Read Community (for V1/V2c Versions)

Setting	Description	Factory Default
Public/Private	Specify the read community security authority level.	public

Read/Write Community (for V1/V2c Versions)

Setting	Description	Factory Default
Public/Private	Specify the read/write community security authority level.	private



NOTE

SNMP V1 and V2c are not secure. We highly recommend using SNMP V3.



NOTE

While the AWK-3252A, AWK-4252A, and AWK-1151C Series use the same firmware and MIB structure, since the AWK-1151C Series only contains client feature sets and lacks DI/DO and Relay hardware interfaces, please be aware that SNMP read or write to non-applicable OIDs for the AWK-1151C Series will return "0 disabled" and "not support" messages.

When finished, click **APPLY**.

Edit an SNMP Account

On the SNMP Account List tab, click the Edit icon  of the account you want to edit.

SNMP						
SNMP		SNMP Account List				
Username	Status	SNMP Status	Authority	Authentication Type	Encryption Method	
 admin	Enabled	Disabled	Read Write	None	None	

Configure the following settings:

Edit SNMP Account Settings

Username
admin

SNMP Status
Enabled

Authority
Read/Write

Authentication Type
None

CANCEL **APPLY**

Username

Setting	Description	Factory Default
admin (read only)	Show the username. This cannot be changed.	Username for the current user

SNMP Status

Setting	Description	Factory Default
Enabled/Disabled	Enable or disable SNMP.	Disabled

Authority

Setting	Description	Factory Default
Read/Write	Give the SNMP account as Read/Write authority.	Read/Write
Read Only	Give the SNMP account Read Only authority.	

Authentication Type

Setting	Description	Factory Default
None	No authority type selected.	None
MD5	Specify MD5 as the authority type.	
SHA	Specify SHA as the authority type.	

Authentication Password

Setting	Description	Factory Default
8 to 63 characters	Depending on the selected Authentication Type, specify the Authentication Password. The password must be at least 8 characters long.	None

Encryption Method

Setting	Description	Factory Default
None	No encryption method selected.	None
DES	Specify DES as the Encryption Method.	
AES	Specify AES as the Encryption Method.	

Encryption Key

Setting	Description	Factory Default
8 to 63 characters	Depending on the selected Encryption Method, specify the Encryption Key. The password must be at least 8 characters long.	None

When finished, click **APPLY**.

Time

From the **Time** section, you can configure the **System Time**.

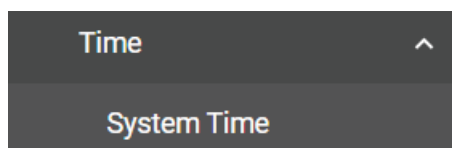

System Time

The **System Time** screen lets you configure the device time settings and specify the time zone. Click **System Time** under **Time** in the function tree to access this screen.

Edit the Clock

The system clock, time, and date can be set manually, or be synced to an external time server.

System Time

System Clock

Time Zone

Current Time
2022-08-23 21:43:06+00:00

Clock Source *
Internal Clock

Date *
2022-08-23

Time *
下午 09:43:06

APPLY
SYNC FROM BROWSER

Configure the following settings:



ATTENTION

You must select the time zone first before configuring "System Clock" settings, as any changes made to the time zone after the system clock has been configured will shift the clock offset based on the deviation of the selected time zone.

Current Time

Setting	Description	Factory Default
Current Time (read only)	Shows the current time.	Current Time

Clock Source

Setting	Description	Factory Default
Internal Clock	Set the clock source to internal. This requires the date and time to be specified manually.	Internal Clock
NTP	Set the clock source to NTP. This will sync the system clock with an external NTP server.	

Configure the Time and Date (Internal Clock)

Date

Setting	Description	Factory Default
Day of the month	Select the current date.	Local

2021 SEP ▾ < >

Su	Mo	Tu	We	Th	Fr	Sa
SEP			1	2	3	4
5	6	7	8	9	10	11
12	13	14	15	16	17	18
19	20	21	22	23	24	25
26	27	28	29	30		

Time

Setting	Description	Factory Default
hh, mm, ss	Specify the current time using the 12-hour AM/PM format. You can manually input the time, or you can click Sync From Browser to sync the time with your web browser.	Sync From Browser

Configure Time Servers (NTP)

System Time

System Clock Time Zone

Current Time
2022-08-31 16:26:58+08:00

Last Sync Timestamp

Clock Source *
NTP

Time Server 1 *
NTP:Server
10 / 60

Time Server 2
0 / 60

Sync Interval *
10
10 - 1440 min.

APPLY

Time Server 1

Setting	Description	Factory Default
NTP time server	Specify the IP or domain address of the primary NTP server to use (e.g., 192.168.1.1, time.stdtime.gov.tw, or time.nist.gov).	None

Time Server 2

Setting	Description	Factory Default
NTP time server	Specify the IP or domain address of the secondary NTP server. The secondary NTP server acts as a backup in case the device fails to connect to the first NTP server.	None

Sync Interval

Setting	Description	Factory Default
10 to 1440 (sec.)	Specify the interval (in seconds) at which the system will sync the clock with the time server.	10

When finished, click **APPLY**.

Edit the Time Zone

You can specify the system clock time zone and apply daylight saving time.

Click the **Time Zone** tab.

System Time

System Clock

Time Zone

Time Zone *
UTC+00:00 ▼

Daylight Saving
Daylight Saving Status *
Disabled ▼

APPLY

Configure the following settings:

Time Zone

Setting	Description	Factory Default
Time zone	Select a time zone.	GMT (Greenwich Mean Time)

Daylight Saving Time

The Daylight Saving Time settings are used to automatically adjust the time according to regional standards.

Daylight Saving

Daylight Saving Status *
Enabled ▼

Offset *
00:00

Start

Month *	Week *	Day *	Hour *
Jan ▼	1st ▼	Sun ▼	00 ▼

End

Month *	Week *	Day *	Hour *
Jan ▼	1st ▼	Sun ▼	00 ▼

APPLY

Daylight Saving Status

Setting	Description	Factory Default
Enabled/Disabled	Enable or disable Daylight Saving Time.	Disabled

Offset

Setting	Description	Factory Default
User-specified value	Specify the offset value for Daylight Saving Time.	None

Start

Setting	Description	Factory Default
User-specified date	Specify the date that Daylight Saving Time begins.	Jan, 1st, Sun, 00.

End

Setting	Description	Factory Default
User-specified date	Specify the date that Daylight Saving Time ends.	Jan, 1st, Sun, 00

When finished, click **APPLY**.

Wi-Fi

From the Wi-Fi section, you can configure the Wireless Settings, Connection Check and Recovery, and Roaming.

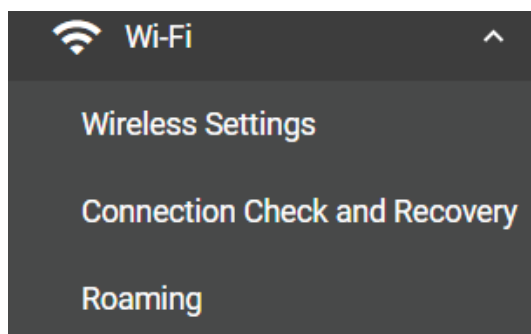

Wireless Settings

On the **Wireless Settings** page, you can configure the device's operating mode, SSID, MAC Cloning settings, as well as check the Wi-Fi connection status. Click **Wireless Settings** under **Wi-Fi** in the function tree to access this screen.

General Settings

The **General** section is used for setting the AWK's operation mode, creating SSIDs, and configuring RF settings. Click the **General** tab to access this screen.

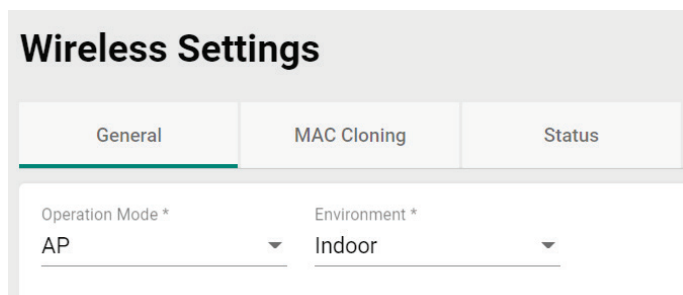

Configure the following settings:

Operation Mode



NOTE

The AWK-1151C is a client device and does not support **AP**, **Master**, and **Mesh** mode.

Setting	Description	Factory Default
Disabled	Disable the operation mode.	Disabled
AP	Specify the operation mode as AP. Refer to AP Mode Settings . (AWK-3252A, AWK-4252A only)	
Master	Specify the operation mode as Master. Refer to Master Mode Settings . (AWK-3252A, AWK-4252A only)	
Mesh	Specify the operation mode as Mesh. Refer to Mesh Mode Settings .	
Sniffer	Specify the operation mode as Sniffer. Refer to Sniffer Mode Settings .	
Client	Specify the operation mode as Client. Refer to Client Mode Settings .	
Client-Router	Specify the operation mode as Client-Router. Refer to Client-Router Mode Settings .	
Slave	Specify the operation mode as Slave. Refer to Slave Mode Settings .	

AP Mode Settings

Select **AP** from the drop-down list of **Operation Mode**. AP Mode requires at least one active SSID.



NOTE

AP mode is only supported by the AWK-3252A and AWK-4252A Series.

Wireless Settings

General | MAC Cloning | Status

Operation Mode *
AP

Environment *
Indoor

Environment

Setting	Description	Factory Default
Indoor	Set the application environment to indoor. Available channels vary depending on the selection.	Indoor
Outdoor	Set the application environment to outdoor. Available channels vary depending on the selection.	

For SSID and security settings, refer to **Add a New SSID**.

For configuring RF settings, refer to **RF Settings**.

When finished, click **APPLY** to change the operation mode.

Master Mode Settings

Select **Master** from the drop-down list of **Operation Mode**. Master Mode requires at least one active SSID.



NOTE

Master mode is only supported by the AWK-3252A and AWK-4252A Series.

Wireless Settings

General MAC Cloning Status

Operation Mode * Environment *

Master Indoor

Environment

Setting	Description	Factory Default
Indoor	Set the application environment to indoor. Available channels vary depending on the selection.	Indoor
Outdoor	Set the application environment to outdoor. Available channels vary depending on the selection.	

For SSID and security settings, refer to **Add a New SSID**.

For configuring RF settings, refer to **RF Settings**.

When finished, click **APPLY** to change the operation mode.

Mesh Mode Settings



NOTE

Mesh mode is only supported by the AWK-3252A and AWK-4252A Series.



NOTE

Mesh topology is **NOT** supported via CLI and SNMP.

Moxa's Mesh mode—also known as AeroMesh—allows the creation of a self-healing, adaptive network. AeroMesh can define a base network, and then extend this topology under certain circumstances. Ordinary mesh networks require cabled backhaul, but with AeroMesh, backhaul can be wireless. To activate Mesh mode, select **Mesh** from the **Operation Mode** drop-down list. Mesh Mode requires at least one active SSID.



NOTE

We suggest deploying the devices in a location with strong signal for maximum effectiveness..



NOTE

The new topology will be adjusted when:

1. A node leaves or joins
2. A new topology was discovered shortly after a status change

Wireless Settings

General	MAC Cloning	Wi-Fi Connections
Operation Mode * Mesh	Environment * Indoor	
Role * Portal		

Environment

Setting	Description	Factory Default
Indoor	Set the application environment to indoor. Available channels vary depending on the selection.	Indoor
Outdoor	Set the application environment to outdoor. Available channels vary depending on the selection.	

Role

Setting	Description	Factory Default
Portal	Set up the device as the portal (MPR), it works like controller. Bridge mesh nodes to form the mesh backhaul. Max. Q'ty: only 1 portal in a mesh network.	Portal
Node	Set up the device as the node (MAP), it works like the agent in mesh network. Establish peer links with another mesh nodes. Max. Q'ty: 10 nodes and 5 hops in a mesh network.	



NOTE

Due to the theoretical value restrictions, throughput is approximately halved over every hop because those mesh nodes will use the same radio interface for control commands and data transmission. Therefore, AeroMesh have limited the amount of node per portal to ensure the workable throughput of the last hop.



NOTE

The performance of the mesh mode may have a 10% reduction compared to other modes because Mesh mode needs to be constantly updated, leading to some bandwidth consumption.



ATTENTION

If set-up for multiple Portals, there will be multiple mesh networks.



ATTENTION

If the portal and hops quantity exceeds the specification, the leftover devices still can join the network but will not provide transmission service.

SSID Settings

Wireless Settings

General
MAC Cloning
Wi-Fi Connections

Operation Mode * Environment *

Mesh Indoor

Role *

Portal

SSID Settings ^

Mesh SSID *

MOXA-AeroMesh 13 / 32

Security *

WPA2/WPA3 Mixed

Mesh Passphrase *

..... 10 / 63

+
Search

<input type="checkbox"/>	SSID	Master / AP	RF Band	Security	Encryption	Status
Max 9 0 of 0						

RF Settings >

Advanced Settings >

APPLY

Mesh SSID

This SSID is used to build the **mesh backhaul**, and the portal and nodes will use the same SSID in one mesh topology to form the network.

- The RF band default select 2.4 GHz Search

<input type="checkbox"/>	SSID	Master / AP	RF Band	Security	Encryption	Status
<input type="checkbox"/>	AP1	AP	5 GHz	WPA2 (Personal)	AES	Enabled
<input type="checkbox"/>	Master1	Master	2.4 GHz	OPEN	—	Enabled
<input type="checkbox"/>	Master2	Master	5 GHz	OPEN	—	Enabled
<input type="checkbox"/>	AP2	AP	5 GHz	OPEN	—	Enabled

Max 9 1 - 4 of 4

AP/Master SSID Table

This SSID setting table is set-up for the AP/Master(**VAP**) to build the STA connection. The functionality is for the data transmission from the end point to the WAN.



NOTE

The Mesh backhaul composed of 5 GHz channels, thus the Mesh SSID will also be 5 GHz. To prevent loss of performance from frequency resource conflicts, It is recommended to set the SSID for AP/Master for 2.4 GHz.

Mesh mode only supports the following methods for higher level encryption:

Security

Setting	Description	Factory Default
WPA2	Use WPA2 authentication. This mode supports IEEE 802.11i with TKIP/AES + 802.1X encryption.	WPA2
WPA2/WPA3 Mixed	Use WPA/WPA3 Mixed authentication. This allows both WPA2 and WPA3 clients to connect to the device.	
WPA3	Use WPA3 authentication. This mode supports SAE (Simultaneous Authentication of Equals) to reduce network attacks, such as KRACK.	

To learn more about SSID and security settings, refer to **Add a New SSID**.

To configure RF settings, refer to **RF Settings**.



NOTE

When role is set- as "Node", the 5 GHz setting will be hidden.



NOTE

The **channel** and **channel width** of the backhaul network are determined by the Mesh portal configuration.

Advanced RF Settings

MTU

Setting	Description	Factory Default
576 to 2290 bytes	MTU (Maximum Transmission Unit) refers to the maximum size of an IP packet that can be transmitted without fragmentation over a given medium.	1500

Mesh RTS/CTS Threshold

Setting	Description	Factory Default
32 to 2346 bytes	Specify the RTS/CTS threshold for the Mesh SSID.	2346

Mesh Management Transmission Rate

Setting	Description	Factory Default
VHT-MCS0-NSS1 to VHT-MCS7-NSS2	Set the management transmission rate for the AWK of Mesh mode.	VHT-MCS0-NSS1

Mesh Broadcast/Multicast Data Transmission Rate

Setting	Description	Factory Default
VHT-MCS0-NSS1 to VHT-MCS7-NSS2	Set the broadcast/multicast data transmission rate for the AWK of Mesh mode.	VHT-MCS0-NSS1

Mesh Threshold

Setting	Description	Factory Default
-85 to -45 dBm	Specify the Signal Strength threshold for Mesh network.	-70



NOTE

Mesh Threshold settings are enabled for **Portal** device role only.



NOTE

RF Type settings **Broadcast/Multicast Data Transmission Rate** and **Mesh Management Transmission Rate** are not supported with "VHT-MCS9-NSS1".

When finished, click **APPLY**.

Checking Mesh Topology (Wi-Fi Connections Menu)

This menu allows you to check Mesh Topology and status from the web interface. It will be displayed on the Portal role UI. Refresh modes can be set to "auto" or "manual" with the buttons in the upper-right corner.

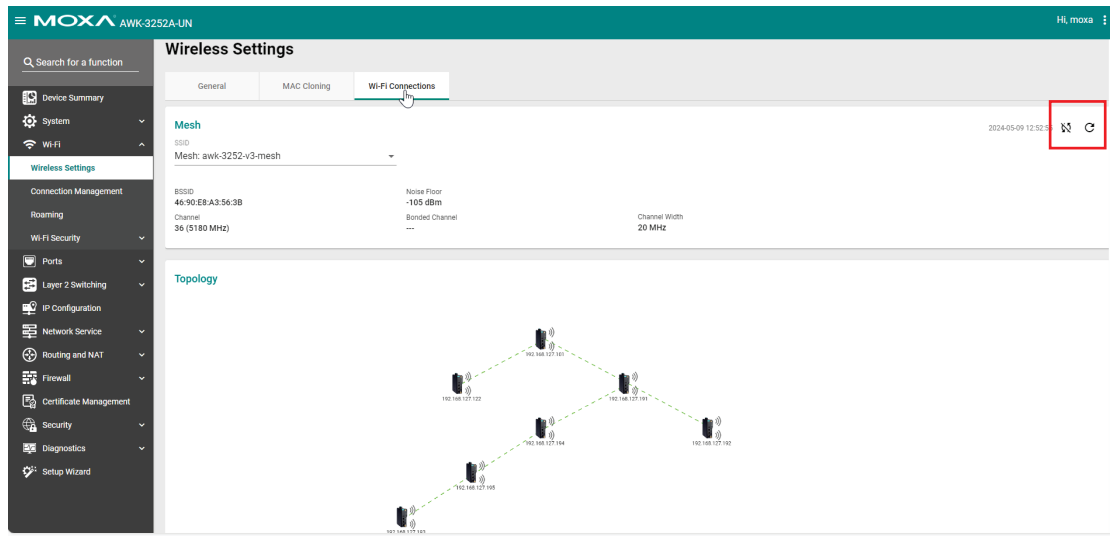

Sniffer Mode Settings

Select **Sniffer** from the drop-down list of **Operation Mode**.

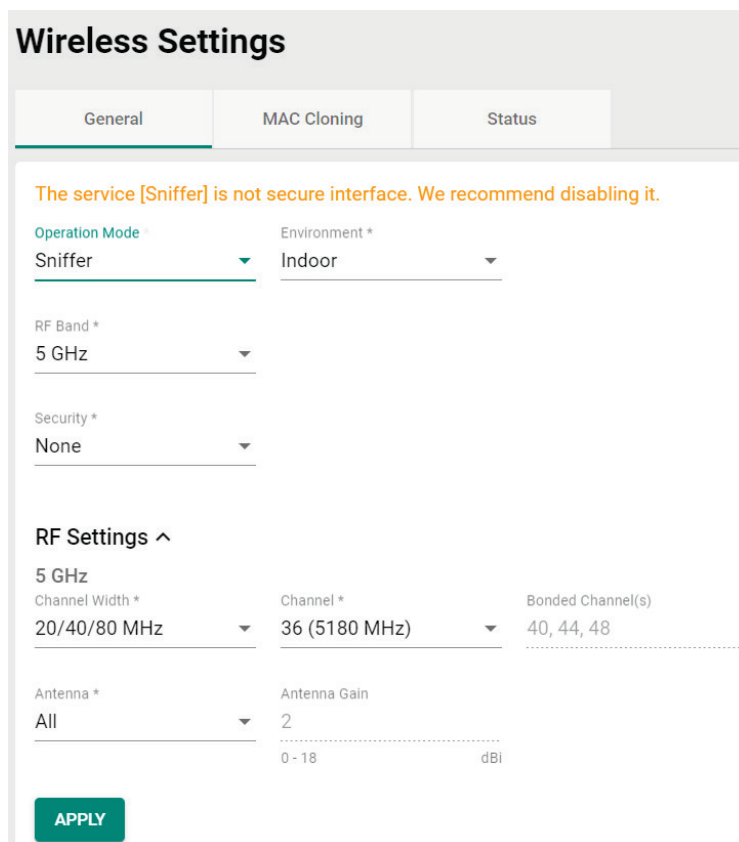

Configure the following settings:

Environment

Setting	Description	Factory Default
Indoor	Set the application environment to indoor. Available channels vary depending on the selection.	Indoor
Outdoor	Set the application environment to outdoor. Available channels vary depending on the selection.	

RF Band

Setting	Description	Factory Default
5 GHz	Select 5 GHz as the RF band.	5 GHz
2.4 GHz	Select 2.4 GHz as the RF band.	
5 GHz & 2.4 GHz	Select both 5 GHz and 2.4 GHz as the RF bands.	

For configuring RF settings, refer to **RF Settings**.

When finished, click **APPLY** to change the operation mode.



NOTE

Once Sniffer and RF settings have been configured, you can add the device's IP as an interface in your network capturing software (e.g. Wireshark) and start capturing packets using Sniffer mode.

Client Mode Settings

Select **Client** from the drop-down list of **Operation Mode**. Client Mode requires at least one active SSID.

The screenshot shows the 'Wireless Settings' page with three tabs: 'General', 'MAC Cloning', and 'Status'. The 'General' tab is active. Below the tabs, there are two dropdown menus: 'Operation Mode' and 'Environment *'. The 'Operation Mode' dropdown is currently set to 'Client', and the 'Environment *' dropdown is set to 'Indoor'.

Configure the following settings:

Environment

Setting	Description	Factory Default
Indoor	Set the application environment to indoor. Available channels vary depending on the selection.	Indoor
Outdoor	Set the application environment to outdoor. Available channels vary depending on the selection.	

For SSID and security settings, refer to **Add a New SSID**.

For configuring RF settings, refer to **RF Settings**.

For configuring advanced settings, refer to **Advanced RF Settings** (Client, Client-Router, Slave Mode Only).

When finished, click **APPLY** to change the operation mode.

Client-Router Mode Settings

Client-Router mode allows you to enable Network Address Translation (NAT) functionality to forward data to LAN ports of connected devices.

Select **Client-Router** from the drop-down list of **Operation Mode**. Client-Router Mode requires at least one active SSID.

Wireless Settings

General	MAC Cloning	Status
Operation Mode Client-Router	Environment * Indoor	

Configure the following settings:

Environment

Setting	Description	Factory Default
Indoor	Set the application environment to indoor. Available channels vary depending on the selection.	Indoor
Outdoor	Set the application environment to outdoor. Available channels vary depending on the selection.	

For SSID and security settings, refer to **Add a New SSID**.

For configuring RF settings, refer to **RF Settings**.

For configuring advanced settings, refer to **Advanced RF Settings** (Client, Client-Router, Slave Mode Only).

When finished, click **APPLY** to change the operation mode.

Slave Mode Settings

Select **Slave** from the drop-down list of **Operation Mode**. Slave Mode requires at least one active SSID.

General	MAC Cloning	Status
Operation Mode * Slave	Environment * Indoor	

Configure the following settings:

Environment

Setting	Description	Factory Default
Indoor	Set the application environment to indoor. Available channels vary depending on the selection.	Indoor
Outdoor	Set the application environment to outdoor. Available channels vary depending on the selection.	

For SSID and security settings, refer to **Add a New SSID**.

For configuring RF settings, refer to **RF Settings**.

For configuring advanced settings, refer to **Advanced RF Settings** (Client, Client-Router, Slave Mode Only).

When finished, click **APPLY** to change the operation mode.

Add a New SSID (AP, Master, Mesh Mode only)

For AP, Master, and Mesh operation modes, configure and enable the SSID profile. There are no SSIDs on the device by default. To add a new SSID, click the **Add +** icon.





NOTE

For more information about Client, Client-Router, and Slave Mode SSID settings, refer to the [Wi-Fi Basic](#) section.

SSID Settings ^

 Q Search

<input type="checkbox"/>	SSID	RF Band	Security	Encryption	Status
<input type="checkbox"/>	 Moxa-5G	5 GHz	WPA2 (Personal)	AES	Enabled
<input type="checkbox"/>	 Moxa-2G	2.4 GHz	WPA2 (Personal)	AES	Enabled

Max 9

Configure the following settings:

Configure SSID Settings

SSID * RF Band *

At least 1 character 7 / 32

RTS / CTS Threshold *

32 - 2346 bytes

Transmission Rate: 5 GHz

Data Transmission Rate * Min. Data Transmission Rate *

0 - 65 Mbps

Broadcast/Multicast Data Transmission Rate * Management Transmission Rate *

SSID Status

Setting	Description	Factory Default
Enabled/Disabled	Enable or disable the SSID.	Disabled

SSID

Setting	Description	Factory Default
1 to 32 characters	Enter a name for the SSID.	None

RF Band

Setting	Description	Factory Default
2.4 GHz	Use the 2.4 GHz RF band on this SSID.	5 GHz
5 GHz	Use the 5 GHz RF band on this SSID.	

RTS/CTS Threshold

Setting	Description	Factory Default
32 to 2346 bytes	Specify the RTS/CTS threshold for the SSID.	2346

Transmission Rate: 5 GHz/2.4 GHz

Data Transmission Rate

Setting	Description	Factory Default
Auto	The AWK Series will automatically sense the speed of the connected device(s) and adjust the data rate accordingly.	Auto

Minimum Data Transmission Rate

Setting	Description	Factory Default
0 to 65 Mbps (0 to disable)	Specify a minimum transmission rate. By setting a minimum transmission rate, the AWK Series will avoid communicating over weak signal wireless links to maintain better wireless performance and optimize the wireless frequency usage.	0 (Disabled)

Broadcast/Multicast Data Transmission Rate

Setting	Description	Factory Default
HT-MCS0 to HT-MCS15	Set the broadcast/multicast data transmission rate for the AWK.	HT-MCS15

Management Transmission Rate

Setting	Description	Factory Default
HT-MCS0 to HT-MCS15	Set the management transmission rate for the AWK.	HT-MCS5

When finished, click **NEXT**.

Configure SSID Settings

2

SSID Broadcast Status *
Enabled

Security * WPA Mode *
WPA2 Personal

Protected Management Frame *
Disabled

Encryption * EAPOL Version *
AES 1

Passphrase *
..... 
At least 8 characters 8 / 64
Key Renew *
3600
60 - 86400 sec.

Copy Configurations to SSIDs 

BACK CONFIRM

SSID Broadcast Status

Setting	Description	Factory Default
Enabled/Disabled	Enable or disable broadcasting the SSID. If enabled, wireless clients will be able to see and connect to this SSID.	Enabled (depending on the settings on the previous page)

Security

Setting	Description	Factory Default
Open	Disable security on the SSID. This is not recommended.	Open
WPA	Use WPA authentication.	
WPA2	Use WPA2 authentication. This mode supports IEEE 802.11i with TKIP/AES + 802.1X encryption.	
WPA3	Use WPA3 authentication. This mode supports SAE (Simultaneous Authentication of Equals) to avoid network attacks, such as KRACK.	
WPA/WPA2 Mixed	Use WPA/WPA2 Mixed authentication. This allows both WPA and WPA2 clients to connect to the AWK.	
WPA2/WPA3 Mixed	Use WPA/WPA3 Mixed authentication. This allows both WPA2 and WPA3 clients to connect to the AWK.	

The AWK Series provides various standardized wireless security modes: **Open**, **WPA** (Wi-Fi Protected Access), **WPA2**, and **WPA3**.

- **Open:** No authentication, no data encryption.
- **WPA/WPA2-Personal:** Also known as WPA/WPA2-PSK. You will need to specify the Pre-Shared Key in the Passphrase field, which will be used by the TKIP or AES engine as a master key to generate keys that encrypt outgoing packets and decrypt incoming packets.
- **WPA3-Personal:** Provide a more secured data connection than WPA2 by using SAE (Simultaneous Authentication of Equals).
- **WPA/WPA2-Enterprise:** Also called WPA/WPA2-EAP (Extensible Authentication Protocol). In addition to device-based authentication, WPA/WPA2-Enterprise enables user-based authentication via IEEE 802.1X. When the Enterprise is selected as the WPA Mode, an additional EAP protocol drop-down field will appear, allowing you to select TLS, TTLS, or PEAP. The EAP-TLS option supports TLS certificates and password upload interface.
- **WPA/WPA2 Mixed:** The AWK supports WPA/WPA2 at the same time. The AWK is able to authenticate with both Wi-Fi clients that use WPA and WPA2.
- **WPA2/WPA3 Mixed:** The AWK supports WPA2/WPA3 at the same time. The AWK is able to authenticate with both Wi-Fi clients that use WPA2 and WPA3.

When using any security mode except **Open**, configure the following settings.

Protected Management Frame

Setting	Description	Factory Default
Disabled	Disable the protected management frame. This option is not available when using WPA3.	Disabled
802.11w	Use 802.11w protocol as the protected management frame.	

WPA Mode

Setting	Description	Factory Default
Personal	Authenticate WPA, WPA2, and WPA3 with a Pre-shared Key (PSK).	Personal
Enterprise	Authenticate WPA, WPA2, and WPA3 with EAP security protocol.	

Encryption

Setting	Description	Factory Default
AES	Use Advance Encryption System (AES) encryption.	TKIP/AES Mixed

Setting	Description	Factory Default
TKIP/AES Mixed*	Use TKIP/AES Mixed encryption. This option provides a TKIP broadcast key and TKIP+AES unicast key to support legacy AP clients. This option is rarely used and is not available when using WAP3.	

*This option is available for legacy mode in AP/Master only and does not support AES-enabled clients.

EAPOL Version

If you selected AES encryption in AP mode, select the EAPOL version.

Setting	Description	Factory Default
1	Use EAPOL Version 1 as the security authentication method.	1
2	Use EAPOL Version 2 as the security authentication method.	

Primary/Secondary RADIUS Server IP (for Enterprise mode only)

Setting	Description	Factory Default
IP address	Specify the RADIUS authentication server for EAP.	None

Primary/Secondary RADIUS Port (for Enterprise mode only)

Setting	Description	Factory Default
0 to 65535	Specify RADIUS server port number.	1812

Primary/Secondary RADIUS Shared Key (for Enterprise mode only)

Setting	Description	Factory Default
0 to 128 characters	Enter the secret key shared for communication between AP and the RADIUS server. The key cannot contain the following special characters: ` ' " ; & \$	None

Passphrase (for Personal mode only)

Setting	Description	Factory Default
8 to 63 characters	Enter the passphrase. This is the master key to generate keys for encryption and decryption. The passphrase cannot contain the following special characters: ` ' " ; & \$ Check Show Password to display the password in clear text.	None

Key Renew

Setting	Description	Factory Default
60 to 86400 seconds (1 minute to 1 day)	Specify the interval at which the group key is renewed.	3600 (seconds)

Copy Configurations to SSIDs

Setting	Description	Factory Default
SSID	Select a target SSID from the drop-down menu to copy the current configuration to.	None



WARNING

The Open mode does not feature any form of authentication and data encryption. For security reasons, we highly recommend NOT to use Open as the security mode.





When finished, click **CREATE** to add a new SSID.

Edit an Existing SSID

To edit an existing SSID, click the **Edit**  icon next to the SSID you want to edit. Refer to **Add a New SSID** for more information about setting.

SSID Settings ^

Some of SSIDs do not apply security type. We recommend disabling them.

	SSID	RF Band	Security	Encryption	Status
<input checked="" type="checkbox"/> 	MoxaGuest_5G	5 GHz	OPEN	---	Enabled
<input type="checkbox"/> 	Moxa-5G	5 GHz	WPA2 (Personal)	AES	Disabled
<input type="checkbox"/> 	Moxa-2G	2.4 GHz	WPA2 (Personal)	AES	Disabled

Max 9





Delete an Existing SSID

To delete an existing SSID, check the SSID, then click the **Delete**  icon above the table.

SSID Settings ^

Some of SSIDs do not apply security type. We recommend disabling them.

 Search

	SSID	RF Band	Security	Encryption	Status
<input checked="" type="checkbox"/> 	MoxaGuest_5G	5 GHz	OPEN	---	Enabled
<input type="checkbox"/> 	Moxa-5G	5 GHz	WPA2 (Personal)	AES	Disabled
<input type="checkbox"/> 	Moxa-2G	2.4 GHz	WPA2 (Personal)	AES	Disabled

Max 9

When prompted, click **DELETE**.

Delete SSID

Are you sure you want to delete the selected ssid?

CANCEL DELETE

RF Settings

When selecting any operation mode, configure the following RF settings.



NOTE

Available RF settings depend on which Operation mode is active: AP, Master, Client, Client-Router, Sniffer, or Slave mode.

RF Settings ^

2.4 GHz
RF Type

G/N Mixed ▾

Channel Width * Channel * Bonded Channel(s)

20/40 MHz ▾ 6 (2437 MHz) ▾ 10

Antenna * Max. Transmission Power * Antenna Gain *

All ▾ 28 2

0 - 28 dBm 0 - 18 dBi

Beacon Interval *

100

40 - 1000 ms.

5 GHz
RF Type *

N/AC Mixed ▾

Channel Width * Channel * Bonded Channel(s)

20/40/80 MHz ▾ 36 (5180 MHz) ▾ 40, 44, 48

Antenna * Max. Transmission Power * Antenna Gain *

All ▾ 26 2

0 - 26 dBm 0 - 18 dBi

Beacon Interval *

100

40 - 1000 ms.

Advanced Settings ^

MTU *

1500

68 - 2290 bytes

APPLY

For 2.4 GHz

Configure the following settings:

RF Type

Setting	Description	Factory Default
G/N Mixed	Enable IEEE 802.11g/n. 802.11n may operate at a slower speed if 802.11g clients are connected to the network.	B/G/N Mixed
B/G/N Mixed	Enable IEEE 802.11b/g/n. 802.11g/n may operate at a slower speed if 802.11b clients are on the network	
N Only (2.4 GHz)	Only enable IEEE 802.11n.	

Channel Width (for 802.11n RF types only)

Setting	Description	Factory Default
20 MHz	Set the channel width to 20 MHz. If you are not sure which option to use, select 20/40 MHz.	20/40 MHz
20/40 MHz	Set the channel width to 20/40 MHz. This is recommended.	

Channel

Setting	Description	Factory Default
1 (2412 MHz) to 11 (2462 MHz)	Select the channel from the drop-down list. Each channel supports different frequencies. Note: Available channels depend on the selected country.	6 (2437 MHz)

Bonded Channel

Setting	Description	Factory Default
10 (read only)	The bonded channel used by the AP will be shown here if channel width is set to 20/40 MHz.	10

Antenna

Setting	Description	Factory Default
1	Specify antenna 1 as the output antenna port.	All
2	Specify antenna 2 as the output antenna port.	
ALL	Specify both antennas as the output antenna port.	

Maximum Transmission power

Setting	Description	Factory Default
dBm	Specify the maximum transmission power which acts as a hard ceiling for different transmission rates.	28 dBm

Antenna Gain

Setting	Description	Factory Default
0 to 18 (dBi)	Specify the antenna gain based on the antenna used.	2



NOTE

The AWK's output power is adjusted based on the specified antenna gain to meet the set maximum transmission power.

Beacon Interval

Setting	Description	Factory Default
40 to 1000 (ms.)	Specify the interval at which a beacon is sent.	100 (ms)

For 5 GHz

Configure the following settings:

RF Type: 5 GHz

Setting	Description	Factory Default
AC Only (5 GHz)	Only enable IEEE 802.11ac.	A/N/AC Mixed
N/AC Mixed	Enable IEEE 802.11n/ac.	
A/N/AC Mixed	Enable IEEE 802.11a/n/ac.	

Channel Width (for any 11N RF type only)

Setting	Description	Factory Default
20 MHz	Set the channel width to 20 MHz. If you are not sure which option to use, select 20/40 MHz.	20/40/80 MHz
20/40 MHz	Set the channel width to 20/40 MHz. This is recommended.	
20/40/80 MHz	Set the channel width to 20/40/80 MHz. If you are not sure which option to use, select 20/40 MHz.	

Channel

Setting	Description	Factory Default
36 (5180 MHz) to 165 (5825 MHz)	Select the channel from the drop-down list. Each channel supports different frequencies.	36 (5180 MHz)

Bonded Channel

Setting	Description	Factory Default
40/44/48 (read only)	The bonded channel used by the AP will be shown here if channel width is set to 20/40/80 MHz.	40/44/48

Antenna

Setting	Description	Factory Default
ALL	Specify both antennas as the output antenna port.	All
1	Specify antenna 1 as the output antenna port.	
2	Specify antenna 2 as the output antenna port.	

Maximum Transmission power

Setting	Description	Factory Default
dBm	Specify the maximum transmission power which acts as a hard ceiling for different transmission rates. Note: The supported Maximum Transmission Power depends on the selected country code.	26 dBm

Antenna Gain

Setting	Description	Factory Default
0 to 18 (dBi)	Specify the antenna gain based on the antenna used.	2



NOTE

The AWK's output power is adjusted based on the specified antenna gain to meet the set maximum transmission power.

Beacon Interval

Setting	Description	Factory Default
40 to 1000 (ms)	Specify the interval at which a beacon is sent.	100 (ms)

When finished, click **APPLY**.

Advanced RF Settings (Client, Client-Router, Slave Mode Only)

Some operation modes require additional advanced RF settings.



NOTE

Available RF settings depend on which Operation mode is active.

Advanced Settings ^

MTU *

1500

68 - 2290 bytes

RTS / CTS Threshold *

2346

32 - 2346 bytes

Transmission Rate: 5 GHz

Data Transmission Rate * Min. Data Transmission Rate *

Auto 0

0 - 65 Mbps

Management Transmission Rat...

HT-MCS5

Configure the following settings:

RTS/CTS Threshold

Setting	Description	Factory Default
32 to 2346 bytes	Specify the RTS/CTS threshold for the SSID.	2346

Transmission Rate: 5 GHz/2.4 GHz

Data Transmission Rate

Setting	Description	Factory Default
Auto	The AWK Series will automatically sense the speed of the connected device(s) and adjust the data rate accordingly.	Auto

Minimum Data Transmission Rate

Setting	Description	Factory Default
0 to 64 Mbps (0 to disable)	Specify a minimum transmission rate. By setting a minimum transmission rate, the AWK Series will avoid communicating over weak signal wireless links to maintain better wireless performance and optimize the wireless frequency usage.	0 (Disabled)

Management Transmission Rate

Setting	Description	Factory Default
HT-MCS0 to HT-MCS15	Set the management transmission rate for the AWK.	HT-MCS5

When finished, click **APPLY**.

MAC Cloning Settings

Enabling this feature allows the AWK client to copy the MAC address of the equipment connected to the LAN. This overcomes the limitation of the IP-Bridged behavior in a MAC-sensitive network (MAC-based communication or MAC-authenticated network).

Wireless Settings

- General
- MAC Cloning**
- Status

MAC Cloning Status *
Enabled

MAC Cloning Method *
Auto

MAC Cloning Interface *
LAN 1

APPLY

Configure the following settings:

MAC Cloning Status

Setting	Description	Factory Default
Enabled/Disabled	Enable or disable the MAC Cloning function.	Disabled

MAC Cloning Method

Setting	Description	Factory Default
Auto	The AWK client copies the MAC address of the device connected to the LAN if only one device is connected to AWK.	Auto
Static	The AWK client shares the assigned MAC address with multiple devices connected to the LAN. This allows for multiple devices to connect to the AWK via the LAN and only one of them needs to be assigned a MAC address.	

MAC Cloning Interface

Setting	Description	Factory Default
LAN 1	Specify the static MAC address of LAN 1 that the connected AWK devices should copy.	LAN 1
LAN 2	Specify the static MAC address of LAN 2 that the connected AWK devices should copy.	

When finished, click **APPLY**.

Wi-Fi Connection Status

To view the Wi-Fi connection status, click **Status** tab. The information on this screen depends on the active operation mode. The following view is from AP Mode.

Wireless Settings

General
MAC Cloning
Status

AP

SSID

AP: Test ▼

BSSID	Noise Floor	
06:90:E8:AA:BB:F1	-104 dBm	
Channel	Bonded Channel	Channel Width
6 (2437 MHz)	10	20/40 MHz

Select the SSID from the drop-down list to view its current status. In Client Mode, you can also view the client list to see all the connected client devices.

Associated Client List

Search

MAC Address	IP Address	Conn. Duration	VHT Cap.	Tx. Rate (Mbps)	Chan. Width (MHz)	Mgmt. SNR. (dB)	Mgmt. SS. (dBm)	Mgmt. Tx. Pkt.

Click the **Filter** icon to select the information items that you want to show.

- MAC Address
- IP Address
- Connection Duration
- VHT Capability
- Transmission Rate

For the Client, Client-Router, and Slave operation modes, this view displays the SSID the device is associated with, and the properties of the connection.

Wireless Settings

General
MAC Cloning
Status

Client 2022-08-31 18:14:24

SSID	MAC Address	Current BSSID	AP IP Address
test	---	---	---
Channel	Bonded Channel	Channel Width	
---	---	---	
Connection Duration	AP Has VHT Capacity		
---	---		
Transmission Rate	Mgmt. SNR.	Signal Strength	Noise Floor
---	---	---	---
Mgmt. Tx. Packets	Mgmt. Rx. Packets		
---	---		
Data Tx. Packets	Data Rx. Packets		
---	---		

Connection Management

Connection Check and Recovery

The **Connection Check and Recovery** tab contains Wi-Fi connectivity tools to define conditions of normal operational criteria and enable recovery attempts without human intervention. Click **Connection Check and Recovery** under **Wi-Fi** in the function tree to access this screen.

Connection Management

Connection Check and Recovery
AP-based Disconnection
Link Fault Pass-through

Client-to-AP Link Check

Client-to-AP Link Check Status *

Disabled ▼

AP Alive Check

AP Alive Check Status *

Disabled ▼

Remote Host Check

Remote Host Check Status *

Disabled ▼

APPLY

Client-to-AP Link Check

When enabled, this recovery mechanism is triggered when the connection to the AP is lost. When disconnected, the device will reset the Wi-Fi interface in an attempt to recover the connection to the AP. If the connection can still not be recovered after the specified number of retries, the client will reboot and check the connectivity status again.

Client-to-AP Link Check

Client-to-AP Link Check Status *

Enabled ▾

Check Timeout *

30

10 - 60 sec.

Reset Connection Recovery * Reset Connection Retry Count *

Enabled ▾ 5

1 - 5

Reboot Recovery * Reboot Retry Count *

Enabled ▾ 5

1 - 5

Configure the following settings:

Client-to-AP Link Check Status

Setting	Description	Factory Default
Enabled/Disabled	Enable or disable the Client-to-AP Link Check function.	Disabled

Check Timeout

Setting	Description	Factory Default
10 to 60 (sec.)	Specify the check timeout interval.	30

Reset Connection Recovery

Setting	Description	Factory Default
Enabled/Disabled	Enable or disable the Reset Connection Recovery function.	Enabled

Reset Connection Retry Count

Setting	Description	Factory Default
1 to 5	Specify the maximum number of times the device will reset the Wi-Fi interface to attempt to recover the connection.	5

Reboot Recovery

Setting	Description	Factory Default
Enabled/Disabled	Enable or disable Reboot Recovery function.	Disabled

Reboot Retry Count

Setting	Description	Factory Default
1 to 5	Specify the maximum number of times the device will reboot to attempt to recover the connection.	5

When finished, click **APPLY** to save your settings.

AP Alive Check

This is a recovery mechanism which checks whether it is still possible to receive data frame from the connected AP. When the timeout is triggered, the client will send a null data packet to probe the AP it is connected to. If the AP does not respond after the specified number of retries, the client will begin scan for other AP candidates in order to recover network communications as quickly as possible.

AP Alive Check

AP Alive Check Status ▼

Enabled ▼

Check Interval * Retry Count *

50 **3**

20 - 1000 ms. 3 - 10

Expiry * ms.

1000

100 - 10000

Threshold Indicate * ▼

SNR

5 GHz **2.4 GHz**

SNR Candidate Threshold * SNR Candidate Threshold *

40 **40**

5 - 60 dB 5 - 60 dB



NOTE

AP alive check is not supported in Mesh mode.

Configure the following settings:

AP Alive Check Status

Setting	Description	Factory Default
Enabled/Disabled	Enable or disable the AP Alive Check function.	Disabled

Check Interval

Setting	Description	Factory Default
20 to 1000 (ms)	Specify the interval at which the device will probe the AP.	50

Retry Count

Setting	Description	Factory Default
3 to 10	Specify the maximum number of times the device will probe the AP.	3

Expiry

Setting	Description	Factory Default
100 to 10000 (ms.)	Specify the connection expiration interval (in ms). If exceeded, the client will consider the AP unreachable or unresponsive, and will trigger the recovery mechanism.	1000

Threshold Indicate

Setting	Description	Factory Default
SNR	Use SNR as the threshold indicator.	SNR
Signal Strength	Use signal strength as the threshold indicator.	

5 GHz: SNR Candidate Threshold (for SNR)

Setting	Description	Factory Default
5 to 60 (dB)	Specify the SNR roaming threshold.	40

2.4 GHz: SNR Candidate Threshold (for SNR)

Setting	Description	Factory Default
5 to 60 (dB)	Specify the SNR roaming threshold.	40

5 GHz: Signal Strength Candidate Threshold (for Signal Strength)

Setting	Description	Factory Default
-100 to -35 (dBm)	Specify the signal strength roaming threshold.	-65

2.4 GHz: Signal Strength Candidate Threshold (for Signal Strength)

Setting	Description	Factory Default
-100 to -35 (dBm)	Specify the signal strength roaming threshold.	-65



NOTE

The SNR and signal strength thresholds are used to determine when the AWK will start looking for a better AP to associate with. If the current connection quality to the AP (based on SNR or signal strength) is lower than the specified threshold value, the client will start looking for other suitable wireless devices.

When finished, click **APPLY**.

Remote Host Check

When enabled, this recovery mechanism is triggered when IP traffic fails to reach the configured remote host. The mechanism works by checking if the remote host is reachable at the defined check interval. If the host is still unreachable after the specified number of retries, the client will disconnect from the current AP and will attempt to associate with another AP.

Remote Host Check

Remote Host Check Status *

Enabled

Host Type *

Static Host *

Check Interval * Check Timeout *

30 1000

1 - 60 sec. 100 - 1000 ms.

Retry Interval * Retry Count *

1 5

1 - 30 sec. 1 - 5



NOTE

Remote host check is not support in Mesh mode.

Configure the following settings.

Remote Host Check Status

Setting	Description	Factory Default
Enabled/Disabled	Enable or disable the Remote Host Check function.	Disabled

Host Type

Setting	Description	Factory Default
Static	Use Static as the host type.	Static
Dynamic	Use Dynamic as the host type.	

Host (for Static Host Type only)

Setting	Description	Factory Default
Host name	Specify the host name.	None

Check Interval

Setting	Description	Factory Default
1 to 60 (sec.)	Specify the interval at which the client will check the connection to the host.	30

Check Timeout

Setting	Description	Factory Default
100 to 10000 (ms)	Specify the connection expiration interval (in ms). If exceeded, the client will consider the remote host unreachable or unresponsive and will trigger the recovery mechanism.	1000

Retry Interval

Setting	Description	Factory Default
1 to 30 (sec.)	Specify the interval at which the device will check the host again after a failed attempt.	1

Retry Count

Setting	Description	Factory Default
1 to 5	Specify the maximum number of times the device will check the host.	5

When finished, click **APPLY**.



NOTE

When this function is enabled in Mesh mode, it only supported on AP/Master SSID.

AP-based Disconnection

The **AP-based Disconnection** tab contains Wi-Fi connectivity tools to configure the signal strength conditions for clients to meet normal operational communication requirements. Additionally, this screen allows users to enable the AP-based disconnection mechanism to disconnect legacy clients without roaming logic in order to encourage these clients to automatically associate to another AP with a stronger signal when falling below the set threshold. Click the **AP-based Disconnection** tab under **Wi-Fi > Connection Management** in the function tree to access this screen.

Connection Management

Connection Check and Recovery | **AP-based Disconnection**

AP-based Disconnection

Search

SSID	SSID Status	AP-based Disconn. Status	Disconn. Threshold
5 GHz: AWK-3252A_ShopFloor	Enabled	Enabled	SNR: 40 dB

Max 9 | 1 - 1 of 1

APPLY

This tab displays all configured SSID profiles on the device. Click the pencil icon next to an SSID to edit the disconnection criteria for legacy clients.

Edit AP-based Disconnection Settings

5 GHz: AWK-3252A_ShopFloor S...

Enabled

Status *

Enabled

Attempts *

3

1 - 10

Indicator of Disconnection Threshold *

SNR

5 GHz

Disconnection Threshold (SNR) *

40

5 - 60 dB

CANCEL APPLY

Status

Setting	Description	Factory Default
Enabled/Disabled	Enable or disable the AP-based Disconnection mechanism.	Disabled

Attempts

Setting	Description	Factory Default
1 to 10	Specify the number of check attempts, with a 1 second interval between each check. If a client's SNR or signal strength falls below the set threshold consecutively for the specified number of attempts, the AP will disconnect the client.	3

Indicator of Disconnection Threshold

Setting	Description	Factory Default
SNR/Signal Strength	Select the threshold type for the disconnection mechanism.	SNR

Disconnection Threshold

Setting	Description	Factory Default
5 to 60 dB for SNR/ -100 to -35 dBm for Signal Strength	Specify the threshold criteria for identifying poor client signal. When the client signal quality falls below the configured threshold, the AP will begin to check the client's signal. If a client's SNR or signal strength falls below the set threshold consecutively for the specified number of attempts, the AP will disconnect the client.	40 dB for SNR -65 dBm for Signal Strength

When finished, click **APPLY**.



NOTE

When this function is enabled in Mesh mode, it is only supported on the fronthaul network.

Link Fault Pass-Through (support on AWK-3252A/AWK-4252A only)

This feature allows the detection of wired link faults. Detection covers local, on-device Ethernet interfaces as well as uplink paths to a wired remote host. If a link fault detected, the AWK AP automatically disables its AP or Master SSID to prevent wireless clients from associating and connecting to an AP that cannot successfully link to the designated application or service on the wired LAN network.

The screenshot shows the 'Connection Management' interface with three tabs: 'Connection Check and Recovery', 'AP-based Disconnection', and 'Link Fault Pass-through'. The 'Link Fault Pass-through' tab is active, showing a status of 'Disabled' with a timestamp '2024-05-03 10:32:21' and refresh icons. Below this, there are two sections: 'Local' and 'Remote'. The 'Local' section has a 'Local Status *' dropdown menu currently set to 'Disabled', with 'Enabled' also visible. Below it is a 'LAN 1' dropdown menu. The 'Remote' section has a 'Remote Status *' dropdown menu currently set to 'Disabled'. At the bottom left of the form is an 'APPLY' button.

Under **Local**, choose Enable from the dropdown menu to detect local LAN interface faults (default Disabled).

Then, choose a LAN port, i.e. the Ethernet cable connected port to monitor.

Local Status Check

Setting	Description	Factory Default
Enabled/Disabled	Enable or disable the Link Fault Pass-through mechanism for wire link fault detection.	Disabled

Additionally, admins can select to enable **Remote** detection from drop down list (default Disabled).

After enabling, fill the mandatory fields—including the target host machine IP—to continuously ping to detect LAN link faults.

Connection Management

Connection Check and Recovery
AP-based Disconnection
Link Fault Pass-through

Link Fault Pass-Through
Disabled

Local

Local Status *
Disabled ▼

Remote

Remote Status *
Enabled ▼

Target *

IPv4 Address/Host 0 / 60

Timeout *
1000

100 - 1000 ms.

Disconnection Detection

Interval * Retry Count *

1 3

1 - 30 sec. 1 - 5

Reconnection Detection

Interval * Retry Count *

1 3

1 - 30 sec. 1 - 5

Remote Status Check

Setting	Description	Factory Default
Enabled/Disabled	Enable or disable the Link Fault Pass-through detected mechanism by remote check.	Disabled

Target

Setting	Description	Factory Default
1-60 characters	IPv4 address or host/domain.	None

Timeout

Setting	Description	Factory Default
100-1000 ms	Specify the check timeout interval	1000

Disconnection Detection Interval

Setting	Description	Factory Default
1-30 sec.	Specify the interval at which the AP will check for disconnection.	1

Disconnection Detection Retry Count

Setting	Description	Factory Default
1-5 times	Specify how many retry attempts for the disconnection check.	3

Reconnection Detection Interval

Setting	Description	Factory Default
1-30 sec.	Specify the interval at which the AP performs reconnection checks.	1

Reconnection Detection Retry Count

Setting	Description	Factory Default
1-5 times	Specify how many retry attempts the AP will make at reconnection.	3

NOTE

When this function is enabled in Mesh mode, it is only supported in the Portal role.

Roaming

The **Roaming** page lets you enable or disable roaming functionality and configure roaming threshold settings. Click **Roaming** under **Wi-Fi** in the function tree to access this screen.

Two roaming types are supported. One is "Client-based Turbo Roaming" and another is "Fast Transition"

Configure the following settings:

Client-based Turbo Roaming

Client-Based Turbo Roaming

Setting	Description	Factory Default
Enabled/Disabled	Enable or disable the Client-based Turbo Roaming function.	Disabled

Fast Transition (for Client/Client-router mode only)

Fast Transition was developed from the 802.11r, and supports roaming performance enhancement through the 802.1X authentication mechanism. It supports WPA2 encryption mode.

The screenshot shows the 'Roaming' configuration page with two tabs: 'Client-based Turbo Roaming' and 'Fast Transition'. The 'Fast Transition' tab is active. The settings are as follows:

- Fast Transition *: Enabled
- Roaming Threshold Indicator *: SNR
- 5 GHz Roaming Threshold (SNR) *: 40 (range 5-60 dB)
- 2.4 GHz Roaming Threshold (SNR) *: 40 (range 5-60 dB)
- Roaming Difference *: 7 (range 5-30)

An 'APPLY' button is visible at the bottom left of the configuration area.

Fast Transition

Setting	Description	Factory Default
Enabled/Disabled	Enable or disable the Fast Transition (802.11r) function.	Disabled



NOTE

In some cases, Fast Transition may have the longer disconnection:

1. Authentication, reassociation, or IE updated failed.
2. AP change keys as client is roaming.
3. If the original AP disappears.



ATTENTION

Unlike Client-based Turbo Roaming, Fast Transition only supports single band roaming and media.



ATTENTION

When Fast Transition is enabled, Client-based Turbo Roaming should be disabled. Fast Transition and Client-based Turbo Roaming cannot be enabled at the same time.

Indicator of Roaming Threshold

Setting	Description	Factory Default
SNR	Use SNR as the roaming threshold indicator.	SNR
Signal Strength	Use signal strength as the roaming threshold indicator.	

5 GHz: Roaming Threshold (for SNR)

Setting	Description	Factory Default
5 to 60 (dB)	Specify the SNR roaming threshold. If the current connection quality is below this threshold, the client will start looking better signal AP to associate with.	40

2.4 GHz: Roaming Threshold (for SNR)

Setting	Description	Factory Default
5 to 60 (dB)	Specify the SNR roaming threshold. If the current connection quality is below this threshold, the client will start looking better signal AP to associate with.	40

5 GHz: Roaming Threshold (for Signal Strength)

Setting	Description	Factory Default
-100 to -35 (dBm)	Specify the signal strength roaming threshold. If the current connection quality is below this threshold, the client will start looking better signal AP to associate with.	-65

2.4 GHz: Roaming Threshold (for Signal Strength)

Setting	Description	Factory Default
-100 to -35 (dBm)	Specify the signal strength roaming threshold. If the current connection quality is below this threshold, the client will start looking better signal AP to associate with.	-65

Roaming Difference

Setting	Description	Factory Default
5 to 30	Specify the roaming difference value.	7



NOTE

The Roaming Threshold determines when clients will start background scanning for other candidate APs with a stronger signal. Once the AWK starts background scanning, the client will compare the connection quality of the current and candidate AP. If the difference is larger than the specified Roaming Difference, the client will roam to the new AP.



NOTE

While the AWK is scanning the background, it will allocate 1/3 of its RF resources to search for candidate APs based on the channel plan configured on the [Wi-Fi > Wireless Settings](#) page. The maximum background scanning time required is proportional to the number of channels checked in channel plan.



NOTE

Once the background scan successfully identifies a candidate AP, the device will roam. The typical Turbo Roaming handover time of < 150 ms is an average of all documented test results, in optimized conditions, across APs configured with interference-free RF channels, and default Turbo Roaming parameters. The clients were configured with 3-channel roaming at 100 Kbps traffic load. Other conditions and factors may affect actual roaming performance.



NOTE

As key renewal is automatic for WPA3 encryption, using Turbo Roaming with WPA3 will result in a one-time increased handover time of approximately 200 ms during the roaming process when the key renewal takes place.

When finished, click **APPLY**.

Client Isolation

The AWK Series supports client isolation functionality for AP-based operation modes to provide an additional layer of security for connected client devices.

For configured virtual access points, select the SSID you wish to enable client isolation for. Client isolation can be either enforced based on SSID where clients connecting to the same SSID on the AP are isolated from each other; or enforced by subnet where clients connecting to the same subnet as the configured SSID will be isolated from each other.

By default, client isolation is not enforced.

Client Isolation

SSID
AP: moxa_guest

Client Isolation

- No isolation
- Isolation within the same SSID
- Isolation within the same subnet



NOTE

When in "AeroMesh" mode, this function only supported on the fronthaul network.

Wi-Fi ACL

The AWK Series supports Wi-Fi ACL filtering for both AP and client-based operation modes. Depending on the active operation mode, Wi-Fi ACL has two purposes. For AP-based operation modes, it blocks rogue client devices attempting to exhaust the Wi-Fi interface's resources. For client-based operation modes, it designates the list of authorized APs for the client to connect to.

There are two types of Wi-Fi ACL, Static or Automatic Wi-Fi ACL. Which type to use depends on the type of unwanted device to filter out through the Wi-Fi interface.

Automatic Wi-Fi ACL

Automatic Wi-Fi ACL will attempt to authenticate incoming device connections based on a specified number of tries. If the device fails all attempts, the AWK will automatically add this device to the list and block all future authentication requests from that device.

The screenshot shows the 'Automatic Wi-Fi ACL' configuration page. At the top, there is a title 'Automatic Wi-Fi ACL' and a status indicator 'Automatic Wi-Fi ACL Status' set to 'Enabled'. Below this is a 'Wi-Fi Authentication Failure Retry Threshold' section with a slider set to '1 - 10' and a unit of 'time (s)'. An 'APPLY' button is located at the bottom left of the configuration area.

Automatic Wi-Fi ACL Status

Setting	Description	Factory Default
Enabled/Disabled	Enable or disable Automatic Wi-Fi ACL.	Disabled

Wi-Fi Authentication Failure Retry Threshold

Setting	Description	Factory Default
1 to 10	Specify the number of client authentication attempts. If the client consecutively fails the specified number of authentication checks, it will consider the client (client or AP) as a rogue device. Automatic Wi-Fi ACL will add the rogue device to the ACL and will block subsequent authentication attempts by this device in the future.	Empty



NOTE

Only management accounts with "Network" authority can manually remove or unlock devices blocked via Automatic Wi-Fi ACL.

When finished, click **APPLY**.

Static Wi-Fi ACL

Static Wi-Fi ACL allows users to manually add devices to the list by MAC address and set the access policy for all entries, either to allow or reject connections from the devices in the list.

Static Wi-Fi ACL

Static Wi-Fi ACL Status: **Enabled**

Static Wi-Fi ACL List Mode: **Enabled**

Wi-Fi ACL Mode: **Block/Accept**

Wi-Fi ACL Status: **Enabled/Disabled**

Search:

Status	MAC Address
<input type="checkbox"/> Enabled	00:90:E8:11:22:33
<input type="checkbox"/> Disabled	---
<input type="checkbox"/> Enabled	00:90:E8:AA:BB:CC

Max 64 Items per page: **10** 1-3 of 3

APPLY

Static Wi-Fi ACL Status

Setting	Description	Factory Default
Enabled/Disabled	Enable or disable Static Wi-Fi ACL.	Disabled

Static Wi-Fi ACL List Mode

Setting	Description	Factory Default
Block/Accept	Choose to either block or accept connections from the MAC addresses in the Static Wi-Fi ACL table.	Empty

When finished, click **APPLY**.

Ports

From the **Ports** section, you can configure **Port Settings**.

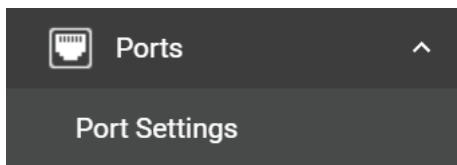

Port Settings



The **Port Settings** page is used to configure the physical LAN 1 and LAN 2 network ports on the device. Click **Port Settings** under **Ports** in the function tree to access this screen.

General Settings

Click **General** tab first, then click the **Edit**  icon on the port you want to configure.

Port Settings

General Port Status

Port	Status	Description
 1	Enabled	
 2	Enabled	

Edit Port 1 Settings

Status
Enabled

Description
0 / 127

CANCEL APPLY

Configure the following settings:

Status

Setting	Description	Factory Default
Enabled/Disabled	Enable or disable the port.	Enabled



ATTENTION

The AWK-1151C Series only has one LAN port (LAN1). If this port is disabled, the device will become inaccessible. The port can only be re-enabled via the console port or by resetting the device to factory default settings using the reset button.

Description

Setting	Description	Factory Default
0 to 127 characters	Enter a description for the port.	None

When finished, click **APPLY**.



ATTENTION

When both LAN1 and LAN2 are enabled, only one LAN port should be used as an uplink. The other LAN port may be used to connect other Ethernet based devices such as IP cameras. Be careful NOT to connect both LAN ports as uplinks to a switch simultaneously to prevent switching loops.

Status Check

Click the **Port Status** tab to check the current port and port link status.

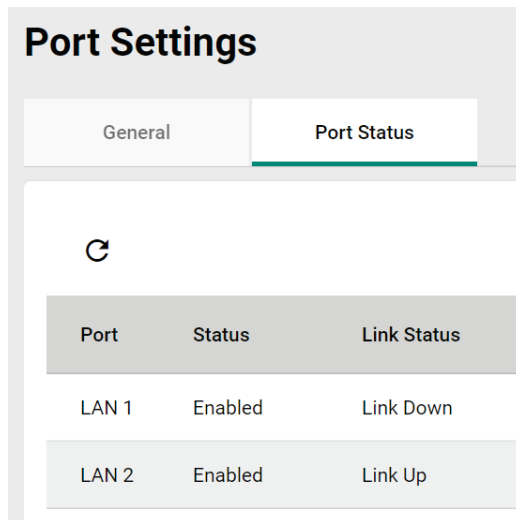

Port	Status	Link Status
LAN 1	Enabled	Link Down
LAN 2	Enabled	Link Up

Layer 2 Switching

This section describes how to configure the VLAN settings for the AWK.

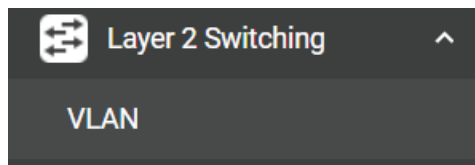

VLAN

The Virtual LAN (VLAN) Concept

What is a VLAN?

A virtual LAN, commonly known as a VLAN, is a group of hosts with a common set of requirements that communicate as if they were connected to the same broadcast domain, regardless of their physical location. A VLAN has the same attributes as a physical LAN, but it allows for end stations to be grouped together even if they are not located on the same network switch. Network reconfiguration can be done through software instead of physically relocating devices.

VLANs now extend as far as the reach of the access point signal. Clients can be segmented into wireless sub-networks via SSID and VLAN assignment. A Client can access the network by connecting to an AP configured to support its assigned SSID/VLAN.

Benefits of VLANs

VLANs are used to conveniently, efficiently, and easily manage your network in the following ways:

- Manage additions, relocations, and changes from a single point of contact
- Define and monitor groups
- Reduce broadcast and multicast traffic to unnecessary destinations
- Improve network performance and reduce latency
- Increase security
- Secure network restricts members to resources on their own VLAN
- Clients roam without compromising security

VLAN Workgroups and Traffic Management

The AP assigns clients to a VLAN based on a Network Name (SSID). The AP can support up to 9 SSIDs per radio interface, with a unique VLAN configurable per SSID.

The AP matches packets transmitted or received to a network name with the associated VLAN. Traffic received by a VLAN is only sent on the wireless interface associated with that same VLAN. This eliminates unnecessary traffic on the wireless LAN, conserving bandwidth and maximizing throughput.

In addition to enhancing wireless traffic management, the VLAN-capable AP supports easy assignment of wireless users to workgroups. In a typical scenario, each user VLAN represents a department workgroup; for example, one VLAN could be used for a marketing department and the other for a human resource department.

In this scenario, the AP would assign every packet it accepted to a VLAN. Each packet would then be identified as marketing or human resource, depending on which wireless client received it. The AP would insert VLAN headers or "tags" with identifiers into the packets transmitted on the wired backbone to a network switch.

Finally, the switch would be configured to route packets from the marketing department to the appropriate corporate resources such as printers and servers. Packets from the human resource department could be restricted to a gateway that allowed access to only the Internet. A member of the human resource department could send and receive e-mail and access the Internet but would be prevented from accessing servers or hosts on the local corporate network.

Global Settings

The **Global Settings** paged is used to configure the management VLAN and interface. Click the **Global** tab to access this screen.

Configure the following settings:

Management VLAN ID

Setting	Description	Factory Default
1 to 4094	Specify the management VLAN of this AWK. By default, there is only VLAN ID 1. Additional VLAN IDs will need to be created first before they can be selected.	1

Management Interface Quick Settings

Management Interface

Setting	Description	Factory Default
Interface	Select the management VLAN interface.	None

Mode

Setting	Description	Factory Default
Access	Access mode is used if the port is connected to a single device, without tags.	Access
Hybrid	Hybrid mode is used if the port is connected to another Access 802.1Q VLAN-aware switch or another LAN that combines tagged and untagged devices.	

PVID

Setting	Description	Factory Default
1 to 4094	Set the default VLAN ID for untagged devices connected to the port.	1

Tagged VLAN

Setting	Description	Factory Default
1 to 4094	If the port type is set to Trunk or Hybrid, specify the VLAN ID for tagged devices that connect to this port.	None

Untagged VLAN

Setting	Description	Factory Default
1 to 4094	If the port type is set to Hybrid, specify the VLAN ID for tagged devices that connect to this port and the tags that need to be removed in egress packets.	Dependent on the selected PVID

When finished, click **APPLY**.

VLAN Settings

From the **Settings** tab, you can create, edit, and delete VLANs. Click the **Settings** tab to access this screen.

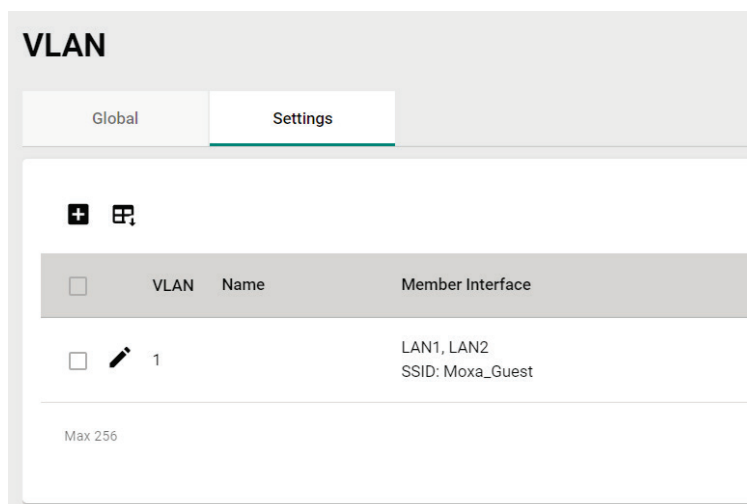

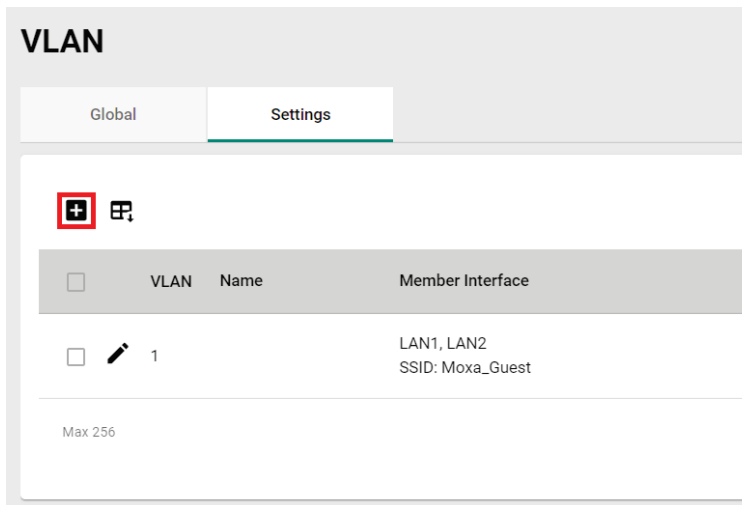

Create a New VLAN ID

To add a new VLAN ID, click the **Add**  icon.



VLAN

Global Settings

 

<input type="checkbox"/>	VLAN	Name	Member Interface
<input type="checkbox"/>	1		LAN1, LAN2 SSID: Moxa_Guest

Max 256

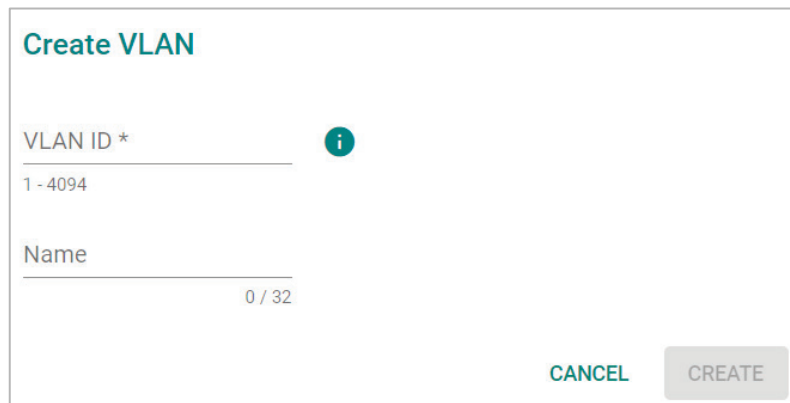

Create VLAN

VLAN ID * 

1 - 4094

Name 0 / 32

CANCEL CREATE

Configure the following settings:

VLAN ID

Setting	Description	Factory Default
1 to 4094	Enter the VLAN ID.	None

Name

Setting	Description	Factory Default
0 to 32 characters	Enter a name for the VLAN.	None

When finished, click **CREATE**.

Edit an Existing VLAN ID

To edit an existing VLAN ID, click the **Edit**  icon next to the VLAN you want to edit.

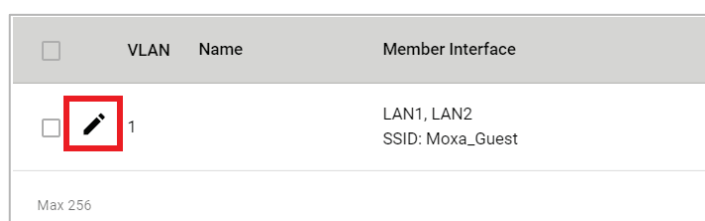

<input type="checkbox"/>	VLAN	Name	Member Interface
<input type="checkbox"/>	1		LAN1, LAN2 SSID: Moxa_Guest

Max 256

Configure the following settings:



NOTE

Once created, the VLAN ID cannot be changed. Only the VLAN name can be edited.

To modify a VLAN ID and VLAN name combination, delete the entry and create a new entry with the desired VLAN ID and name.



Name

Setting	Description	Factory Default
0 to 32 characters	Enter a name for the VLAN ID.	None

When finished, click **APPLY**.

Edit VLAN Interface Settings

To edit the VLAN interface settings, click the **Edit**  icon next to the interface you want to edit.

Interface	Mode	PVID	Untagged VLAN
 LAN1	Access	1	1
 LAN2	Access	1	1
 SSID: .M-Guest	Access	1	1

Edit Interface LAN1 Settings

Mode *
Access ▼

PVID *
1 ▼

Tagged VLAN ▼

.....

Untagged VLAN
1 ▼

.....

Copy Configurations to Interfaces ▼ 

CANCEL APPLY

Configure the following settings.

Mode

Setting	Description	Factory Default
Access	Access mode is used if the port is connected to a single device, without tags.	Access
Hybrid	Hybrid mode is used if the port is connected to another Access 802.1Q VLAN-aware switch or another LAN that combines tagged and untagged devices.	

PVID

Setting	Description	Factory Default
1 to 4094	Set the default VLAN ID for untagged devices connected to the port.	1

Tagged VLAN

Setting	Description	Factory Default
1 to 4094	If the port type is set to Hybrid, specify the VLAN ID for tagged devices that connect to this port.	None

Untagged VLAN

Setting	Description	Factory Default
VID range from 1 to 4094	If the port type is set to Hybrid, specify the VLAN ID for tagged devices that connect to this port and the tags that need to be removed in egress packets.	1

Copy Configurations to Interfaces

Setting	Description	Factory Default
Interface	Select the interface to copy the configuration of this interface to.	None

When finished, click **APPLY**.

IP Configuration

The **IP Configuration** section is used to configure the device's basic IP configuration. Click **IP Configuration** in the function tree.

General Settings

The **General** tab lets you configure the device's basic network information. Click the **General** tab to access this screen.

The screenshot shows the 'IP Configuration' interface with three tabs: 'General', 'IPv6', and 'Status'. The 'General' tab is active. Under the 'LAN' section, the 'IP Mode' is set to 'Static'. Below this, there are input fields for 'IP Address *' (192.168.127.253), 'Subnet Mask *' (24 (255.255.255.0)), and 'Default Gateway'. There are also fields for 'DNS Server 1' and 'DNS Server 2'. An 'APPLY' button is located at the bottom left of the configuration area.

Configure the following settings.

IP Mode

Setting	Description	Factory Default
DHCP	The AWK is assigned an IP address automatically by the network's DHCP server.	Static
Static	Manually configure up the AWK's IP address.	

IP Address

Setting	Description	Factory Default
IP address	Enter the AWK's IP address.	192.168.127.253

Subnet mask

Setting	Description	Factory Default
Subnet mask	Select the subnet mask. This is used to identify the type of network the AWK is connected to (e.g., 255.255.0.0 for a Class B network, or 255.255.255.0 for a Class C network).	24 (255.255.255.0)

Default Gateway

Setting	Description	Factory Default
IP address	Enter the IP address of the router that connects the LAN to an outside network.	None

DNS Server 1 and DNS Server 2

Setting	Description	Factory Default
IP address	Enter the primary and secondary DNS server address. After entering the DNS server's IP address, you can input the AWK's URL (e.g., http://ap11.abc.com) in your browser's address field instead of entering the IP address. The Secondary DNS server will be used if the Primary DNS server fails to connect.	None

When finished, click **APPLY**.

IP Configuration Status

To view the status of the current IP configuration, click the **Status** tab.

IP Configuration

General IPv6 **Status**

LAN

IP Mode
Static

IP Address 192.168.127.253	Subnet Mask 255.255.255.0	Default Gateway ---
DNS Server 1 ---	DNS Server 2 ---	

IP Conflict Check
Pass

IPv6 Mode
Static

IPv6 Address
2001:b011:20e0:cb8:211:32ff:fe88:1d16/64

IPv6 Default Gateway

IPv6 DNS Server 1 ---	IPv6 DNS Server 2 ---
--------------------------	--------------------------

IPv6

IPv6 provides other technical benefits in addition to a larger addressing space. IPv6 addresses are represented as eight groups of four hexadecimal digits each, separated by colons. The full representation may be shortened; for example, 2001:0db8:0000:0000:0000:8a2e:0370:7334 becomes 2001:db8::8a2e:370:7334.

The AWK-1151C/3252A/4252A Series supports IPv4 and IPv6 dual stack design, allowing devices to configure both IPv4 and IPv6 addresses, and can communicate with other nodes in the LAN or the Internet using either IPv4 or IPv6. The DNS protocol is used by both IP protocols to resolve fully qualified domain names and IP addresses, but dual stack requires that the resolving DNS server can resolve both types of addresses.

The configuration options vary depending on model and configuration of AWK-1151C/3252A/4252A Series devices.

LAN (All operation modes except Client-router mode)

In all modes other than Client-router mode, the AWK acts as a bridge device, receiving and transmitting data within same network segment. These modes are effectively LAN-only, and support the following two IP addressing methods: Static and Dynamic

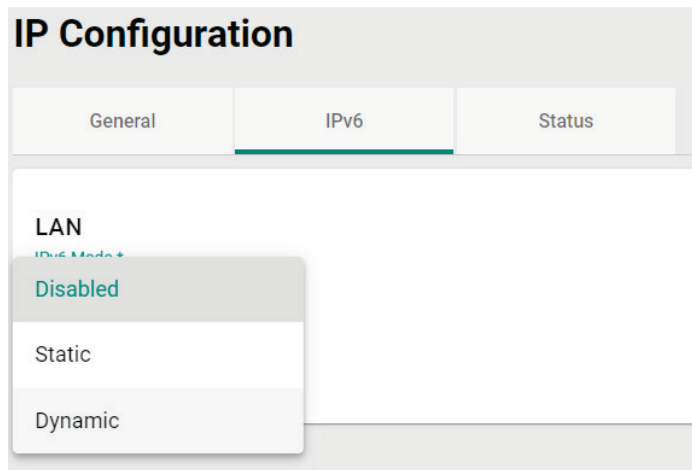

LAN > Static

Select this option when IPv6 client requires manual configuration. Fill in the following fields and click Apply to enable manually configured IPv6 address.

IPv6 Mode *	
Static	
IPv6 Address *	Prefix Length *
Required	0 - 128
IPv6 Gateway	
IPv6 DNS Server 1	IPv6 DNS Server 2
APPLY	

Setting	Description	Factory Default
IPv6 Address	Configure the eight groups of four hexadecimal digits, e.g. 2001:b011:20e0:cb8:211:32ff:fe88:1d16	None
Prefix Length	Designate the IPv6 Prefix Length 0 ~ 128. This is equivalent to IPv4 subnet mask.	
IPv6 Gateway	Designate the IPv6 Gateway if applicable in network.	
IPv6 DNS Server 1	Designate the primary IPv6 DNS server.	
IPv6 DNS Server 2	Designate the backup IPv6 DNS server.	

LAN > Dynamic

LAN

IPv6 Mode *

Dynamic ▾

APPLY

Select this option to configure the device as an auto-IPv6 client. IPv6 addresses will be automatically acquired from upstream IPv6 DHCP server.

WAN (Client-router mode Only)

In Client-router mode, the device acts as a router. You can specify additional IPv6 options for WAN IP acquisition. Note that all modes except Static require additional configuration in Client mode first. In Client mode, configure LAN IPv6 address first, then select Client router mode and click Apply.

IP Configuration

General

IPv6

Status

Disabled

Static

Dynamic

Relay

DHCPv6-PD

Prefix Length *

0 - 128

IPv6 DNS Server 1

IPv6 DNS Server 2

APPLY

WAN > Static option

Select this option when IPv6 client requires manual configuration. Fill in the following fields and click **Apply** to enable manual configured IPv6 address.

IPv6 Mode *
Static

IPv6 Address * Prefix Length *
Required 0 - 128

IPv6 Gateway

IPv6 DNS Server 1 IPv6 DNS Server 2

APPLY

Setting	Description	Factory Default
IPv6 Address	Configure the eight groups of four hexadecimal digits, e.g. 2001:b011:20e0:cb8:211:32ff:fe88:1d16	None
Prefix Length	Designate the IPv6 Prefix Length 0 ~ 128. This is equivalent to IPv4 subnet mask.	
IPv6 Gateway	Designate the IPv6 Gateway if applicable.	
IPv6 DNS Server 1	Designate the primary IPv6 DNS server.	
IPv6 DNS Server 2	Designate the backup IPv6 DNS server.	

WAN > Dynamic option

WAN

IPv6 Mode *
Dynamic

APPLY

Select this option when to configure AWK as an auto IPv6 client, automatically acquiring IPv6 addresses and DNS server addresses from an upstream IPv6 DHCP server. This option will acquire IPv6 addresses for AWK device only, not any connected clients.

WAN > Relay option

WAN

IPv6 Mode *
Relay

APPLY

Select this option to configure the device as an autoconfigured IPv6 client an relay agent, automatically acquiring IPv6 addresses and DNS server addresses from upstream IPv6 DHCP server in network. This option not only acquires IPv6 address for AWK device, but also relays LAN-connected IPv6 client requests to upstream servers.

WAN > DHCPv6-PD option

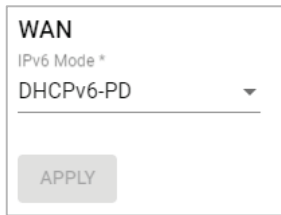

WAN
IPv6 Mode *
DHCPv6-PD
APPLY

Select this option to configure the device as an autoconfigured IPv6 client and prefix delegator, automatically acquiring IPv6 addresses and DNS server addresses from upstream IPv6 DHCP servers. This allows the device to automatically delegate IPv6 prefixes and assign IP addresses to connected devices based on DHCPv6 Server configurations.

Network

From the **Networking** section, you can configure **DHCP Server** settings.

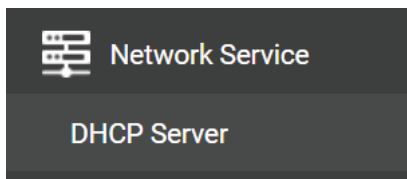

DHCP Server

The **DHCP Server** section is used for configuring a local DHCP server for IP provisioning to connected devices. DHCP Server is only available for AP/Master/Client-Router operation modes. If the device is in Client-Router mode, the DHCP service applies to LAN interfaces for wired connected devices.

IP addresses can be assigned in one of two ways:

- Dynamic: The DHCP server automatically assigns IP addresses to devices from a configured IP address range.
- Static: Users manually map an IP address to a specific MAC address.

If necessary, users can use a mixed provisioning model with both dynamic DHCP pool and MAC-based IP assignment. In a mixed DHCP mode environment, the system will first check if the device is listed in the MAC-based IP assignment table. If no matching entry is found, the system will assign an IP address from the configured DHCP IP pool.



NOTE

Due to a functional limitation, if the device's own IP is acquired through DHCP, the DHCP Server feature cannot be enabled on the device.

DHCP Pool ^

Status *
Enabled

IP Address : Start * 192.168.127.59 IP Address : End * 192.168.127.77

MAC-based IP Assignment ^

+ Q Search

<input type="checkbox"/>	Hostname	MAC Address	IP Address	Status
Max 32 0 of 0				

APPLY

DHCPv6 Server

DHCPv6 Server default is disabled. Enable this feature to assign IPv6 address to connected devices.

If the AWK has configured IPv6 via Static or DHCPv6-PD method. It supports the provisioning of IPv6 addresses to connect devices downstream of AWK LAN ports via three configurable DHCPv6 options from the drop-down menu.

DHCPv6 Server

General Lease Table

DHCPv6 Server Mode *

Disabled i

SLAAC + RDNSS

Stateless DHCPv6

Stateful DHCPv6

Setting	Description
SLAAC + RDNSS	Connected device or IPv6 client issue Router Solicitation (RS) and interprets IPv6 Prefix, Default Gateway, DNS address from Router Advertisement (RA) and compose its IPv6 address parameters by combining prefix with self-generated host ID.
Stateless DHCPv6	Connected device or IPv6 client issue Router Solicitation (RS) and interprets IPv6 Prefix, Default Gateway, from Router Advertisement, Advertisement (RA) and compose its IPv6 address parameters by combining prefix with self-generated host ID. Subsequently it issues DHCP Solicit and interpret the DHCPv6 Advertise to extract DNS address.
Stateful DHCPv6	Connected device or IPv6 client issue Router Solicitation (RS) and interprets Default Gateway address from Router Advertisement, Advertisement (RA). Subsequently it issues DHCP Solicit / Request and interpret the DHCPv6 Advertise / Reply respectively to extract DNS address and issued IPv6 address. Benefit of Stateful DHCPv6 option is the state of all issued IPv6 address may be monitored and managed in the DHCPv6 server.

For all three options, configure **Lease Time** of issued IPv6 address ranging from 2 ~ 14400 min. Default lease time is 1440 mins.

DHCPv6 Server

General

Lease Table

DHCPv6 Server Mode *
 i

Lease Time *

2 - 14400 min.

DNS Server 1 DNS Server 2

Additionally, if the selected option is **Stateful DHCPv6** option. The lease IPv6 address can be created to specify mapping relationships designating specific IPv6 addresses to specific MAC devices.

MAC-based IPv6 Assignment ^

+
Search

<input type="checkbox"/>	Hostname	MAC Address	IPv6 Suffix	Status
Max 32				0 of 0

Remote

Remote Status *

Target *
 0 / 60

Timeout *

100 - 1000 ms.

Disconnection Detection

Interval *

1 - 30 sec.

Retry Count *

1 - 5

Reconnection Detection

Interval *

1 - 30 sec.

Retry Count *

1 - 5

The criteria of a LAN link fault can be customized depending on nature of application by detection frequency configured in **Disconnection Detection** parameters where admin can define the detection Interval and Retry Count criteria for AWK to deem the target remote host unreachable, triggering the shutdown of SSID service.

The **Reconnection Detection** parameters automatic link check to see if remote host access has been restored. If the configured remote host is accessible within the configured Interval and Retry Count criteria, the AWK will deem the link fault to target host has been successfully repaired or restored, triggering the re-activation of SSID service for wireless clients to connect.

Gratuitous ARP (for Client/Client-router mode only)

Gratuitous ARP is a broadcast packet that the client (the AWK device) sends to all nodes in WLAN to share or update the latest IP/MAC mapping table of AWK device or legacy device behind AWK device to prevent nodes from dropping packets.

Status

Setting	Description	Factory Default
Enabled/Disabled	Enable or disable Gratuitous ARP functionality. Enabling this function helps detect and prevent unstable connections.	Disabled

When enabled, the function behaves differently depending on the operation mode of the device. Refer to the following descriptions:

- **Client mode:** You can enter the IP/MAC address of the legacy device connected to the Ethernet port of the AWK device. AWK device will send the Gratuitous ARP to WLAN in following cases:
 - a. AWK own IP with AWK MAC address
 - b. Configured IP with AWK MAC address
- **Client-Router mode:** You need to enable **NAT** for GARP first to allow the server on the AP side to access the devices connected to the Ethernet ports of the AWK device. The AWK will send the GARP packet to WLAN as:
 - a. AWK own WAN IP with AWK MAC address
 - b. NAT **1-to-1**: With AWK **own WAN MAC address** and the configured **1-to-1 IP** by user in the NAT configuration.



ATTENTION

NAT function must be enabled as the Gratuitous ARP is enabled in client-router mode.

Interval

Setting	Description	Factory Default
10-1000 seconds	Specify the interval at which GARP packets are sent.	180

Users can press the “+” to create the GARP entry first, then enabling the information individually once need to send the table to inform the nodes in the WLAN.

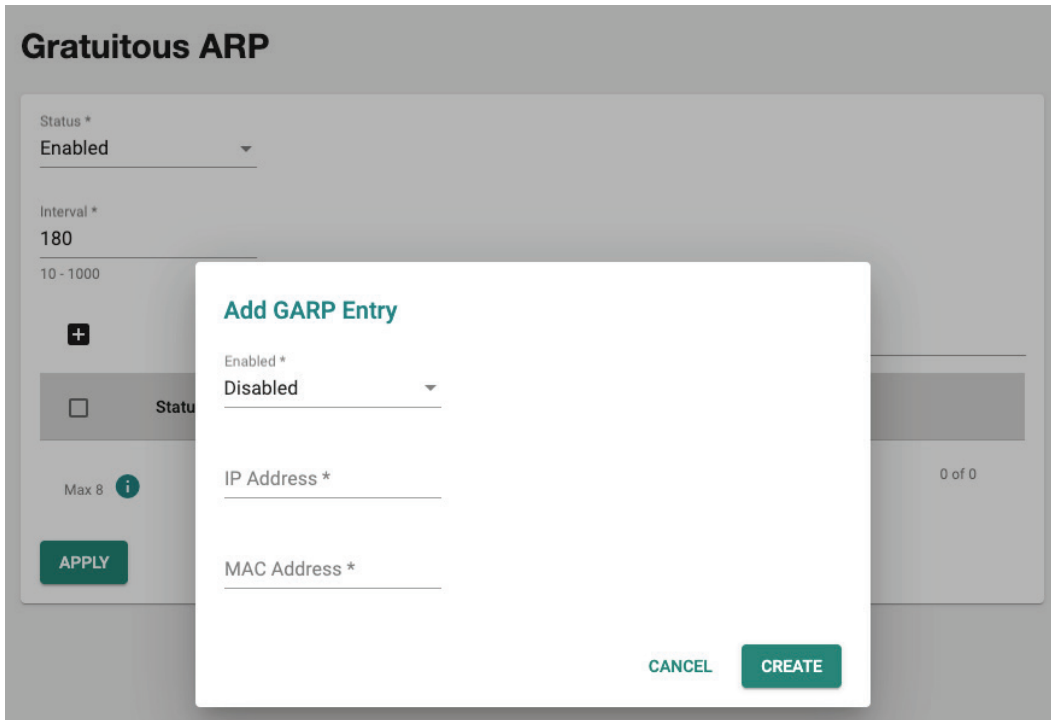

Add GARP Entry

Setting	Description	Factory Default
Enabled/Disabled	Enable or disable each GARP packet is sent actively.	Disabled
IP/MAC address	The corresponding IP/MAC address of the devices behind the AWK client. You can specify up to 8 entries.	Empty



ATTENTION

When specifying an IP or MAC address, you must provide the associated IP and MAC address for that entry.

Routing and NAT

From the **Routing and NAT** section you can configure **Routing** and **NAT** settings.

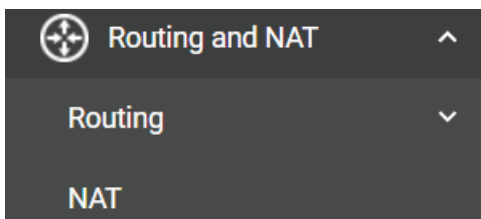

Routing

The **Routing** section is used for managing static routes and checking the routing table.

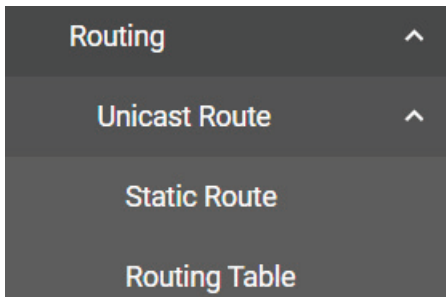

Unicast Route

Static Route Settings

You can create, edit, and delete static route entries from the **Static Route** page. Click **Static Route** under **Routing > Unicast Route** in the function tree.

Create a New Static Route

Click the **Add**  icon to create a new entry.

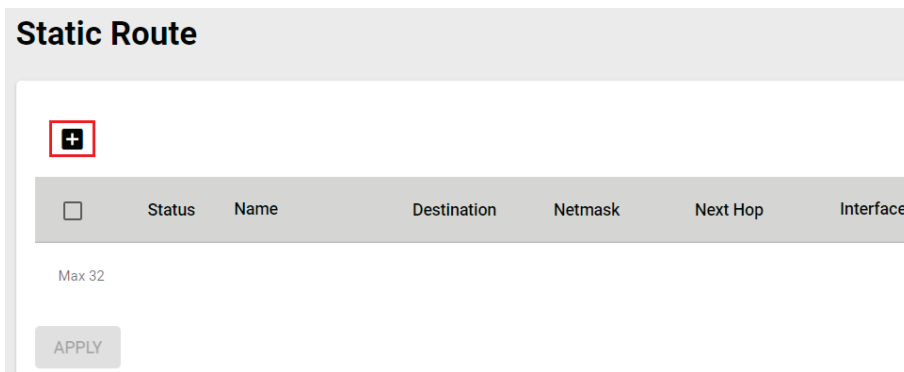

Create Static Route Entry

Entry Status *
 Disabled ▾

Name

 0 / 31

Destination *

Netmask *
 24 (255.255.255.0) ▾

Next Hop

Interface *
 WAN ▾

Metric
 1 - 32766

CANCEL CREATE

Configure the following settings:

Entry Status

Setting	Description	Factory Default
Enabled/Disabled	Enable or disable the static route entry.	Disabled

Name

Setting	Description	Factory Default
0 to 31 characters	Enter a name for the static route entry.	None

Destination

Setting	Description	Factory Default
IP address	Specify the destination IP address.	None

Netmask

Setting	Description	Factory Default
IP address	Specify the subnet mask for this IP address.	24 (255.255.255.0)

Next Hop

Setting	Description	Factory Default
IP address	Specify the next gateway IP address. This IP address should be in the same subnet as the specified interface.	None

Interface

Setting	Description	Factory Default
Interface	Select the network interface for this route.	WAN

Metric

Setting	Description	Factory Default
1 to 32766	Specify the cost metric this route. Routes with a lower metric value take priority over routes with a higher cost.	None

When finished, click **CREATE**.

Routing Table

To view the current routing table, click **Routing Table** under **Routing > Unicast Route** in the function tree.

Routing Table



Destination	Netmask	Gateway	Interface	Metric
192.168.0.0	255.255.255.0	0.0.0.0	LAN	0

NAT

The AWK Series supports Network Address Translation (NAT) and Port Forwarding in Client-Router operation mode. This feature translates the outgoing communication from private IPs to external IPs (WAN IP).



Network Address Translate

The **NAT** page lets you enable NAT functionality and manage NAT rules. Click **NAT** in the function tree.

Network Address Translate

Rule List

NAT Global Status *
Enabled ▼

  Q Search

<input type="checkbox"/>	Status	Name	Description	Pri.	Mode	Protocol	WAN IP : Port	LAN IP : Port
<input type="checkbox"/>	 Enabled			32	N-to-1	--	--	--

Max 32 Items per page: 10 ▼ 1 - 1 of 1 ◀

Configure the following setting:

NAT Global Status

Setting	Description	Factory Default
Enabled/Disabled	Enable or disable the NAT function.	Enabled

Add a New NAT Rule

To add a new NAT rule, click the **Add**  icon.

Create NAT Rule

Rule Status *
Disabled ▼

Name
 0 / 31

Description
 0 / 127

Priority *
1

1 - 31

NAT Mode *
 ▼

CANCEL
APPLY

Configure the following settings:

Rule Status

Setting	Description	Factory Default
Enabled/Disabled	Enable or disable the NAT rule.	Disabled

Name

Setting	Description	Factory Default
0 to 31 characters	Enter a name for this rule.	None

Description

Setting	Description	Factory Default
0 to 127 characters	Enter a description for this rule.	None

Priority

Setting	Description	Factory Default
1 to 31	Specify the priority for this rule.	1

NAT Mode

Setting	Description	Factory Default
1 to 1	Set the NAT mode to 1-to-1.	None
PAT	Set the NAT mode to PAT (Port Address Translation).	

Mapping Type (1 to 1 Mode only)

Setting	Description	Factory Default
Single to Single	Set the mapping type to Single to Single.	Single to Single
Range to Range	Set the mapping type to Range to Range.	
Subnet to Subnet	Set the mapping type to Subnet to Subnet.	

Mapping Type (PAT Mode only)

Setting	Description	Factory Default
Single Port	Set the mapping type to Single Port.	Single Port
Multiple Ports	Set the mapping type to Multiple Ports.	

Protocol (PAT Mode only)

Setting	Description	Factory Default
TCP/UDP	Specify the protocol.	TCP, UDP

WAN

Setting	Description	Factory Default
IP address	For 1-to-1 mode only. Specify the IP address for the WAN.	None
0 to 65535	For PAT mode only. Specify the TCP or UDP port number for the WAN.	None

LAN

Setting	Description	Factory Default
IP address	Specify the LAN IP address.	None
0 to 65535	For PAT mode only. Specify the LAN TCP or UDP port number.	None

Click **APPLY** to create the new NAT rule.

For **1 to 1 NAT Mode** and **PAT Mode**, refer to the following figure illustrations.

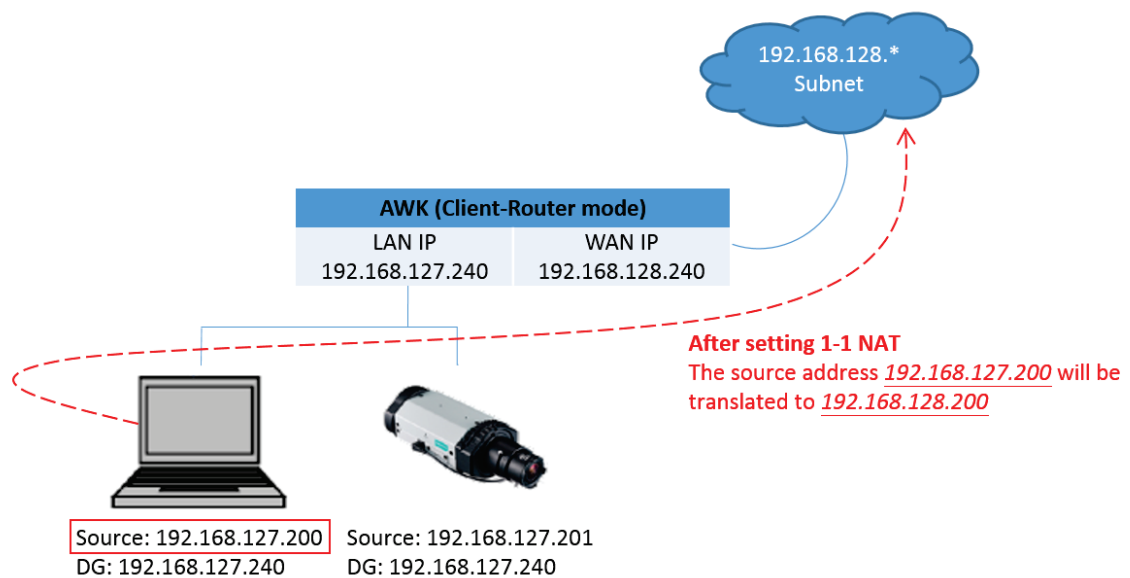
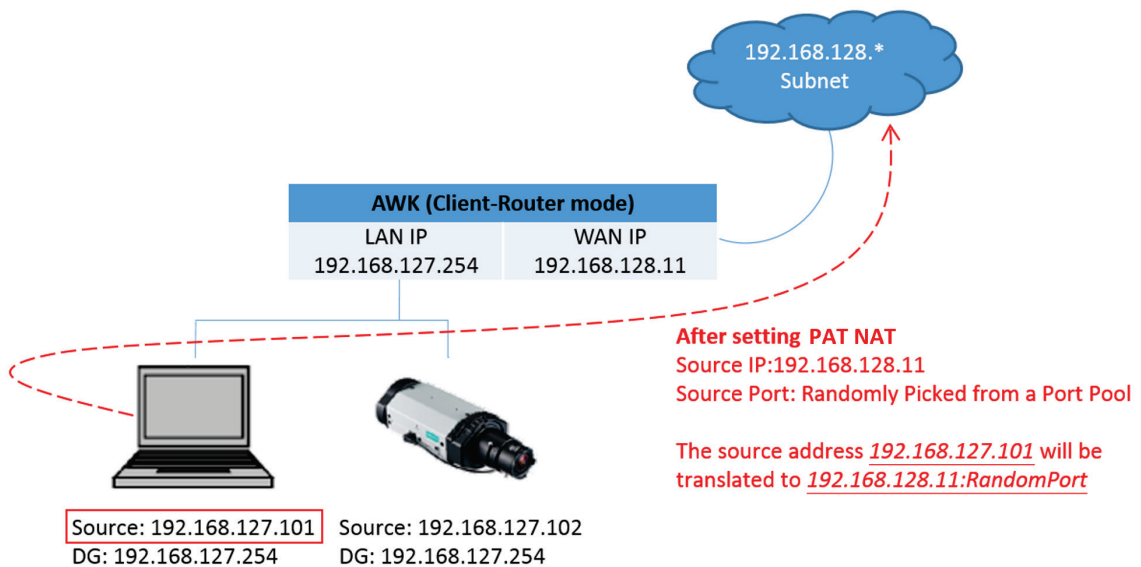

Edit an Existing NAT Rule

To edit an existing NAT rule, click the **Edit**  icon next to the rule you want to edit.
Refer to

Add a New NAT Rule for more information about each setting.

<input type="checkbox"/>	Status	Name	Description	Pri.	Mode
<input type="checkbox"/>	Enabled			32	N-to-1

Edit NAT Rule

Rule Status *
Enabled

Name
0 / 31

Description
0 / 127

Priority
32
1 - 32

NAT Mode
N-to-1

CANCEL **APPLY**

When finished, click **APPLY**.

View the NAT Rule Status

You can view the status of all NAT rules from the NAT rule list page.

<input type="checkbox"/>	Status	Name	Description	Pri.	Mode	Protocol	WAN IP : Port	LAN IP : Port
<input type="checkbox"/>	Enabled	Rule 1	Rule 1 for the field site	32	N-to-1	--	--	--

Max 32 Items per page: 10 1 - 1 of 1

You select what information you want to view by clicking **Select Visible Columns**  icon and checking the corresponding check boxes.

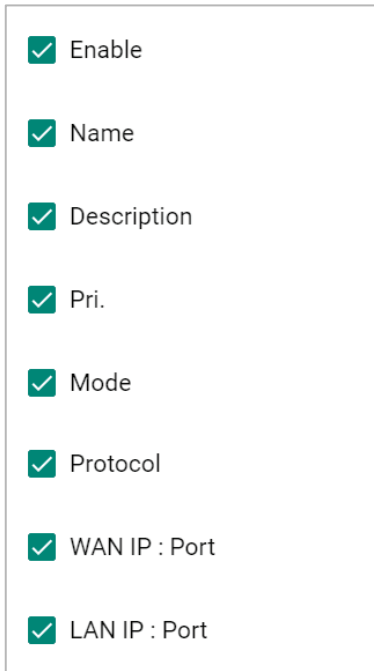
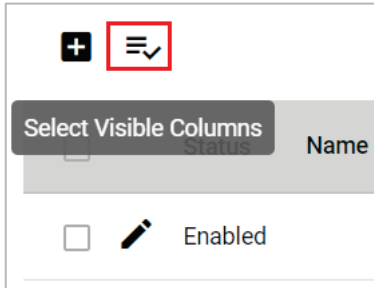

Only information for the selected items will be shown.

<input type="checkbox"/>	Status	Name	Description	Mode	WAN IP : Port	LAN IP : Port
<input checked="" type="checkbox"/>	Enabled	Rule 1	Rule 1 for the field site	N-to-1	---	---

Max 32 Items per page: 10 ▼ 1 - 1 of 1

Firewall

The **Firewall** section contains the **Layer 2 Policy** and **Layer 3 Policy** configuration pages.

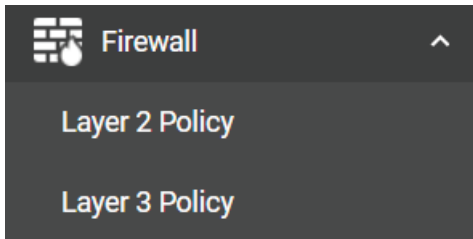

Layer 2 Policy

From the **Layer 2 Policy** screen, you can manage the L2 firewall policy and create, edit, and delete policy rules. Click **Layer 2 Policy** under **Firewall** in the function tree to access this screen.

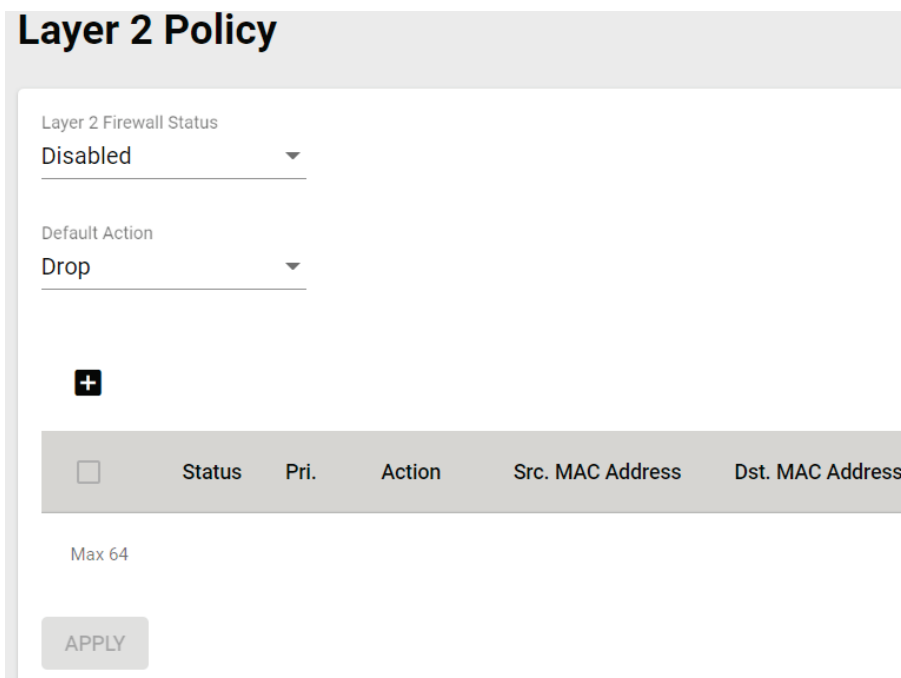
A screenshot of the "Layer 2 Policy" configuration screen. At the top, there is a header "Layer 2 Policy". Below it, there are two dropdown menus: "Layer 2 Firewall Status" set to "Disabled" and "Default Action" set to "Drop". Below these is a plus sign icon for adding rules. A table header is visible with columns: "Status", "Pri.", "Action", "Src. MAC Address", and "Dst. MAC Address". Below the table header, it says "Max 64". At the bottom, there is an "APPLY" button.

Configure the following settings:

Layer 2 Firewall Status

Setting	Description	Factory Default
Enabled/Disabled	Enable or disable the Layer 2 firewall function.	Disabled

Default Action

Setting	Description	Factory Default
Accept	Accept all packets that do not match any policy rule.	Drop
Drop	Drop all packets that do not match any policy rule.	



ATTENTION

Be careful when configuring the packet filtering function:

If the default action is set to **Drop** and **all rules are disabled, all packets will be denied.**

If the default action is set to **Accept** and **all rules are disabled, all packets will be allowed.**

When finished, click **APPLY** to save your changes.

Add a New Layer 2 Firewall Rule

To add a new Layer 2 firewall rule, click the **Add**  icon.

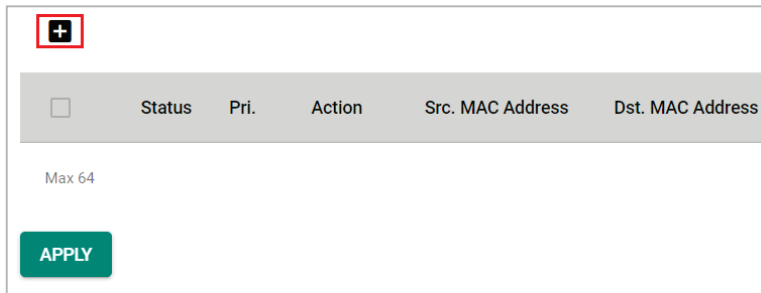

Configure the following settings:

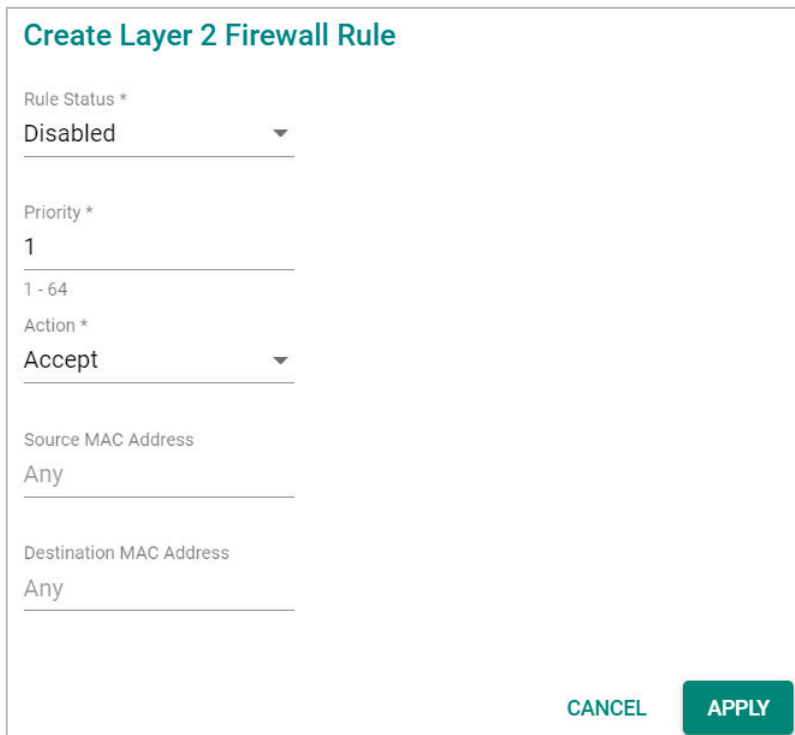

Rule Status

Setting	Description	Factory Default
Enabled/Disabled	Enable or disable the Layer 2 firewall rule.	Disabled

Priority

Setting	Description	Factory Default
1 to 64	Specify the priority for this rule. A lower number represents a higher priority. Rules with a higher priority will be checked and enforced first.	1

Default Action

Setting	Description	Factory Default
Accept	Packets that match the policy rule will be allowed.	Accept
Drop	Packets that match the policy rule will be denied.	



ATTENTION

Be careful when configuring the packet filtering function:

If the default action is set to **Drop** and **all rules are disabled, all packets will be allowed.**

If the default action is set to **Accept** and **all rules are disabled, all packets will be denied.**

Source MAC Address

Setting	Description	Factory Default
MAC address	Enter the source MAC address.	Any

Destination MAC Address

Setting	Description	Factory Default
MAC address	Enter the destination MAC address.	Any

When finished, click **APPLY**.

Layer 3 Policy

From the **Layer 3 Policy** screen, you can manage the L3 firewall policy and create, edit, and delete policy rules. Click **Layer 3 Policy** under **Firewall** in the function tree to access this screen.

Layer 3 Policy

Layer 3 Firewall Status
Disabled ▼

Default Action
Drop ▼

+

	Status	Pri.	Action	Protocol	Src. IP Address : Port	Dst. IP Address : Port
<input type="checkbox"/>						

Max 64

APPLY

Configure the following settings.

Layer 3 Firewall Status

Setting	Description	Factory Default
Enabled/Disabled	Enable or disable the Layer 3 firewall function.	Disabled

Default Action

Setting	Description	Factory Default
Accept	Packets that match the policy rule will be allowed.	Drop
Drop	Packets that match the policy rule will be denied.	



ATTENTION

Be careful when configuring the packet filtering function:

If the default action is set to **Drop** and **all rules are disabled**, all packets will be allowed.

If the default action is set to **Accept** and **all rules are disabled**, all packets will be denied.

When finished, click **APPLY**.

Add a New Layer 3 Firewall Rule

To add a new Layer 3 firewall rule, click the **Add**  icon.

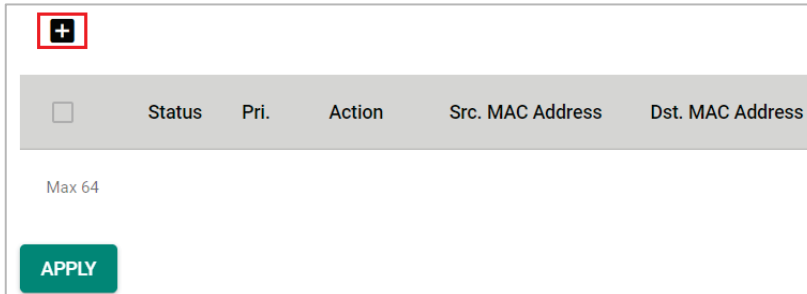

Configure the following settings:

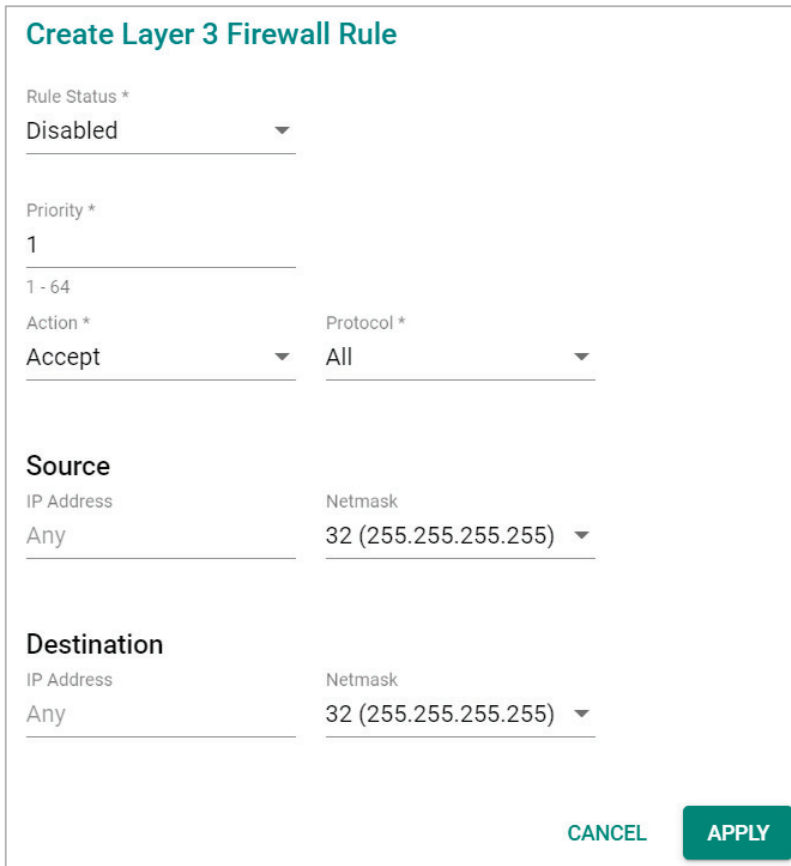

Rule Status

Setting	Description	Factory Default
Enabled/Disabled	Enable or disable the Layer 3 firewall rule.	Disabled

Priority

Setting	Description	Factory Default
1 to 64	Specify the priority for this rule.	1

Default Action

Setting	Description	Factory Default
Accept	Packets that match the policy rule will be allowed.	Accept
Drop	Packets that match the policy rule will be denied.	

Protocol

Setting	Description	Factory Default
All	Filter all protocol traffic.	All
ICMP	Only filter for ICMP protocol traffic.	
TCP	Only filter for TCP protocol traffic.	
UDP	Only filter for UDP protocol traffic.	

The AWK's IP protocol filter is a policy-based filter that can allow or filter out IP-based packets with specified IP protocol and source/destination IP addresses.

The AWK provides 64 entities for setting IP protocol and source/destination IP addresses in your filtering policy. Four IP protocols are available: **All**, **ICMP**, **TCP**, and **UDP**. You must specify either the Source IP or the Destination IP. By combining IP addresses and netmasks, you can specify a single IP address or a range of IP addresses to accept or drop. For example, "IP address 192.168.1.1 and netmask 255.255.255.255" refers to the sole IP address 192.168.1.1. "IP address 192.168.1.1 and netmask 255.255.255.0" refers to the range of IP addresses from 192.168.1.1 to 192.168.255.

Source

IP Address

Setting	Description	Factory Default
IP address	Specify the source IP address.	Any

Netmask

Setting	Description	Factory Default
Netmask	Select the subnet mask	32 (255.255.255.255)

Port Range

Setting	Description	Factory Default
0 to 65535	If the Protocol is set to TCP or UDP, specify the port range.	None

Destination

IP Address

Setting	Description	Factory Default
IP address	Specify the destination IP address.	Any

Netmask

Setting	Description	Factory Default
Netmask	Specify the subnet mask.	32 (255.255.255.255)

Port Range

Setting	Description	Factory Default
0 to 65535	If the Protocol is set to TCP or UDP, specify the port range.	None

When finished, click **APPLY**.

Certificate Management

The **Certificate Management** page provides a holistic presentation of all the configuration features that support certificate-based authentication. From this dashboard table, administrators can easily review and edit device or Server CA certificates without having to navigate to the individual feature's configuration page, simplifying and speeding up certificate management tasks.

For example, administrators can update the certificate and key of Syslog Server 1 through the **Certificate Management** page, instead of having to navigate to **Diagnostics > Event Logs and Notifications > Syslog > Authentication** to perform the same task.

Basic Concept of SSL

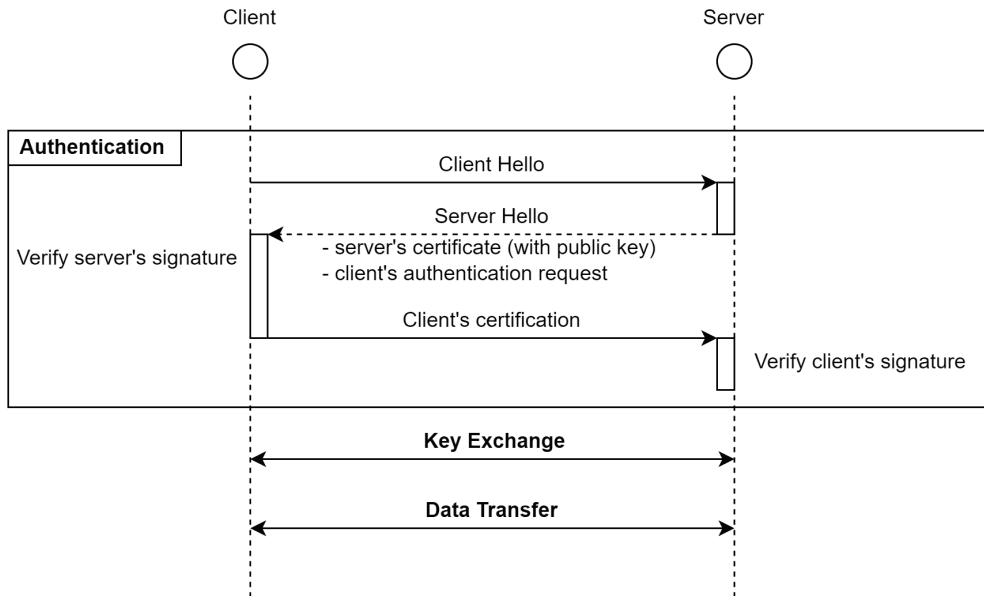

Device Certificate

The **Device Certificate** table shows the current certificate for the listed functions. The AWK Series supports different certificates for different functions to increase security and minimize the potential risk in the event a certificate is compromised.

Certificate Management						
Device Certificate						
Function	Issue To	Issue By	Start Date	Expiration Date	Serial Number	
Data Transferring	moxa-awk-4252a	moxa-awk-4252a	Jun 10 11:35:54 2022 GMT	Jun 9 11:35:54 2027 GMT	1DAD0CC136A68BD8BFAE9F23FD5E7A170E50637A	
HTTPS	moxa-awk-4252a	moxa-awk-4252a	Jun 14 15:11:30 2022 GMT	Jun 13 15:11:30 2027 GMT	68E874CE1A7DD76482FDD48BC2A92356C602CB73	
RSSI Report	moxa-awk-4252a	moxa-awk-4252a	Jun 10 11:36:20 2022 GMT	Jun 9 11:36:20 2027 GMT	17A4505C1B765433A2BE95A6021A820E418EAF31	
Syslog Server 1	moxa-awk-4252a	moxa-awk-4252a	Jun 14 15:15:23 2022 GMT	Jun 13 15:15:23 2027 GMT	260770B9701E5BA73694EE5FBD9EA48B005011AA	
Syslog Server 2	moxa-awk-4252a	moxa-awk-4252a	Jun 10 11:36:02 2022 GMT	Jun 9 11:36:02 2027 GMT	3470D83D8615E1259F693BA4E20AC62F07FF63E7	
Syslog Server 3	moxa-awk-4252a	moxa-awk-4252a	Jun 10 11:36:18 2022 GMT	Jun 9 11:36:18 2027 GMT	136CB52E4FE0CF16EE41222AA49F74CF2D9FC6FA	
Wi-Fi Client	moxa-awk-4252a	moxa-awk-4252a	Jun 10 11:36:23 2022 GMT	Jun 9 11:36:23 2027 GMT	18DD4729FAE2FB21F7A9CA72AC23D833F19B36DD	
Wi-Fi Sniffer and Wi-Fi Mirroring	moxa-awk-4252a	moxa-awk-4252a	Jun 10 11:36:31 2022 GMT	Jun 9 11:36:31 2027 GMT	02A8B18961592530FDEEC61C226CD81D14AD7BDE	

Max 8 1 - 8 of 8

Table Field Name	Description
Function	The list of certificate-based authentication functions: <ul style="list-style-type: none"> • Data Transferring • HTTPS • RSSI Report • Syslog Server 1/2/3 • Wi-Fi Client • Wi-Fi Sniffer and Wi-Fi Mirroring
Issue To	The entity the certificate was issued to.
Issue By	The entity the certificate was issued by.
Start Date	The valid start date of the certificate.
Expiration Date	The expiration date of the certificate.
Serial Number	The unique serial number of the certificate.

By default, the certificates applied on the device are self-signed by the AWK device. It is recommended to update the self-signed certificate or upload a certificate issued by a trusted certificate authority (CA) for any functions that will be actively used.

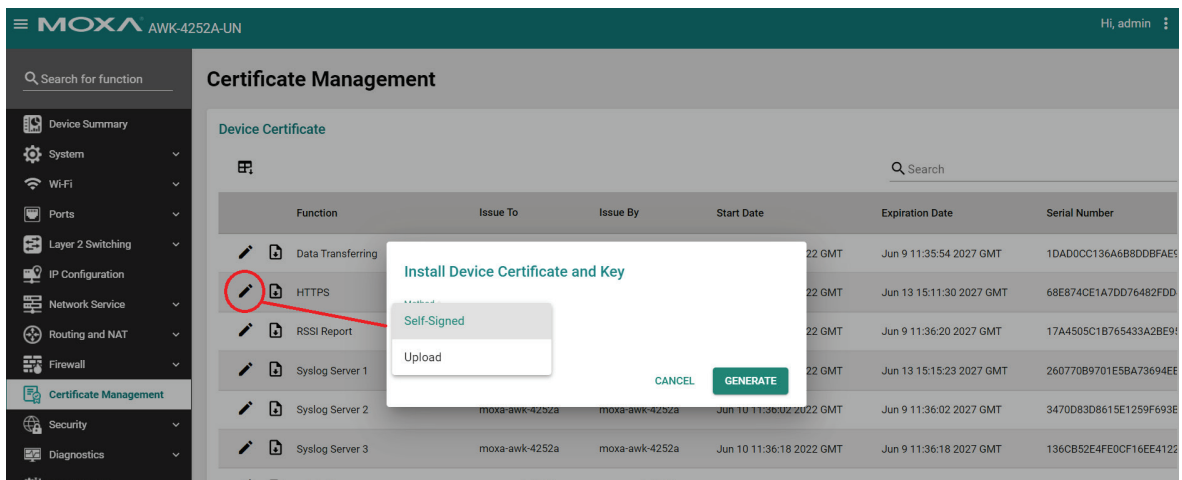

Server CA Certificate

From the **Server CA Certificate** screen, administrators can upload third-party trusted CA certificates which are used to verify the authenticity of received server certificates during the signature verification process of the listed applications.

Server CA Certificate

Function	Issue To	Issue By	Start Date	Expiration Date	Serial Number
<input type="checkbox"/> Data Transferring	---	---	---	---	---
<input type="checkbox"/> Email Notification	---	---	---	---	---
<input type="checkbox"/> RSSI Report	---	---	---	---	---
<input type="checkbox"/> Syslog Server 1	---	---	---	---	---
<input type="checkbox"/> Syslog Server 2	---	---	---	---	---
<input type="checkbox"/> Syslog Server 3	---	---	---	---	---
<input type="checkbox"/> Wi-Fi Client	---	---	---	---	---

Max 7 1 - 7 of 7



ATTENTION

The AWK Series device will automatically check and issue a warning message if the uploaded certificate has expired or was not issued by a trusted CA. Please note that the device will not automatically connect to public key infrastructure (PKI) to verify whether the uploaded certificate has been revoked or not. It is highly recommended to take additional measures to manually confirm the validity of the certificate (i.e. valid and not revoked) before uploading it to the device.

Security

The **Security** section lets you configure **Device Security** settings.

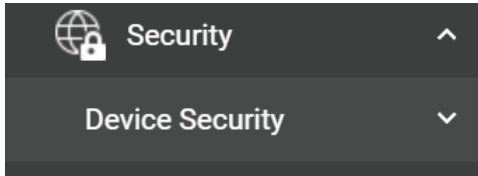

Device Security

This section describes how to configure the settings for **Login Policy**.

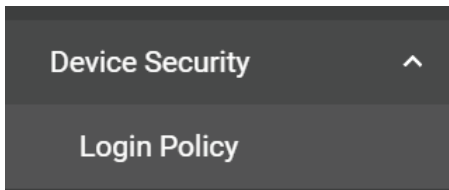

Login Policy

On the **Login Policy** page, you can configure login messages and login security functions. Click **Login Policy** under **Security > Device Security** in the function tree to access this screen.

Login Policy

Login Message

0 / 500

Login Failure Message

Failed to login

15 / 500

User Lockout Status *

Enabled ▼

Login Failure Retry Threshold *

5

1 - 10 time(s)

Lockout Period *

5

1 - 10 min.

Session Lifetime *

10

5 - 14400 min.

APPLY

Configure the following settings:

Login Message

Setting	Description	Factory Default
0 to 500 characters	Enter the message that will be displayed on the login screen when accessing the device.	None

Login Failure Message

Setting	Description	Factory Default
0 to 500 characters	Enter the message that will be displayed when users fail to log in.	Failed to login

User Lockout Status

Setting	Description	Factory Default
Enabled/Disabled	Enable or disable the lockout function when a user fails to log in.	Enabled

Login Failure Retry Threshold

Setting	Description	Factory Default
1 to 10	Specify the maximum number of times a user can attempt to log in again after a failed attempt.	5

Lockout Period

Setting	Description	Factory Default
1 to 10 (min.)	Specify the duration (in minutes) the user will be unable to log in for after exceeding the number of allowed retries.	5

Session Lifetime

Setting	Description	Factory Default
5 to 1440 (min.)	Specify how long a user can be inactive for before being automatically logged out and be required to log in again.	10

When finished, click **APPLY**.

Security Status

The Security Status screen consolidates the security status of all active interfaces of the device. This table serves as a review tool to ensure that the device's configuration meets the desired IEC-62443 Security Level (SL) profile. If any of the configuration risks do not meet your organization's security policy, check the description, and navigate to the corresponding configuration page to address the issue. If the identified risk cannot be directly mitigated through the AWK Series' configuration, such as an active unsecure protocol to support legacy devices, consider consulting a qualified security expert to implement additional measures to mitigate the risk.

The screenshot shows the Security Status interface. At the top, there is a 'Feature Group' dropdown set to 'All' and a search bar. Below this is a table with three columns: 'Status', 'Risk Level', and 'Risk Description'. The table contains three rows of risk information:

Status	Risk Level	Risk Description
	HIGH	Enable HTTP to access this device.
	HIGH	Enable Telnet to access this device.
...
	LOW	Firewall is not enabled to restrict network access.

Below the table is a 'Feature Group' dropdown menu with the following options: All (default), User Interface, Event Logs and Notifications, System, Service, and Network.

Field	Description
Status	The representative icons indicate if there are any risks that require mitigating action, and the corresponding severity of the risk. Risks that have been addressed will be marked with a checkmark.
Risk Level	The device categorizes risks into three tiers: Low: Risks vulnerable to exploitation per circumstances defined in SL3 and above. Medium: Risks vulnerable to exploitation per circumstances defined in SL2. High: Risks vulnerable to exploitation per circumstances defined in SL1.
Risk Description	Additional details describing the risk to provide administrators with context for taking the appropriate hardening action.

Trusted Access

In order to prevent DoS attacks, the Trusted Access feature allows authorized users to designate the IP or MAC addresses that are allowed to access this device. When configured and enabled, the Trusted Access list will only allow the specified IP or MAC addresses access to the corresponding interfaces, databases, or services.

Trusted Access applies to the following interfaces, databases, and services:

- User interfaces: HTTP/HTTPS, SSH/Telnet, SNMP, New Moxa Command.
- Event logs and notifications: Syslog, Email notifications, SNMP Trap/Inform.
- Services: DHCP Server, Wi-Fi Sniffer, Mirroring with Remote Type.

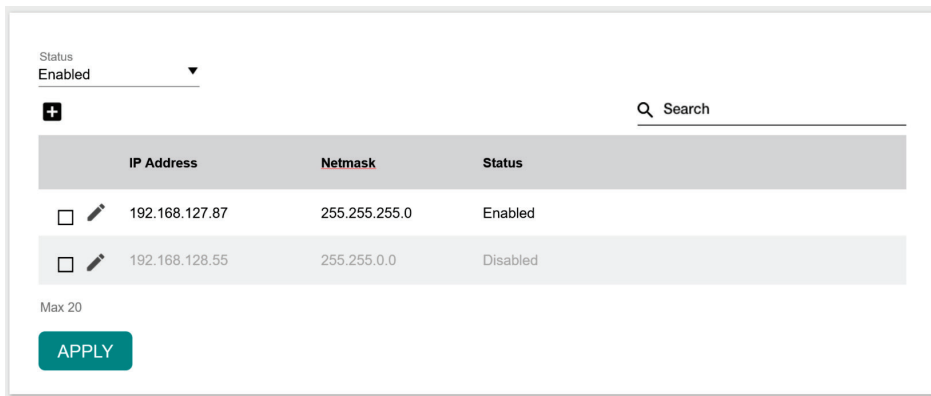

Diagnostics

The **Diagnostics** section is used for monitoring and troubleshooting and includes the **System Status**, **Network Status**, **Event Logs and Notifications**, and **Tools** pages.

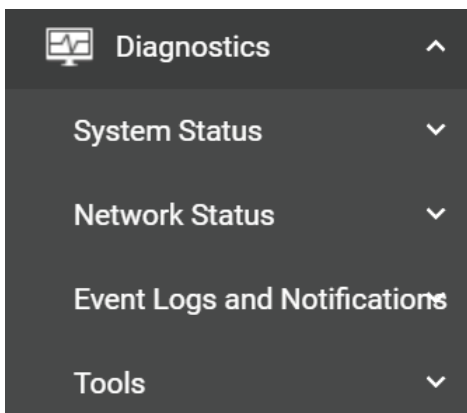

System Status

Utilization

The **Utilization** screens features widgets and charts showing the real-time resource usage of the AWK. Click **Utilization** under **Diagnostics > System Status** in the function tree to access this screen.

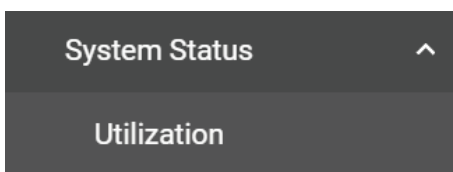

CPU Usage

This widget shows the current CPU usage.

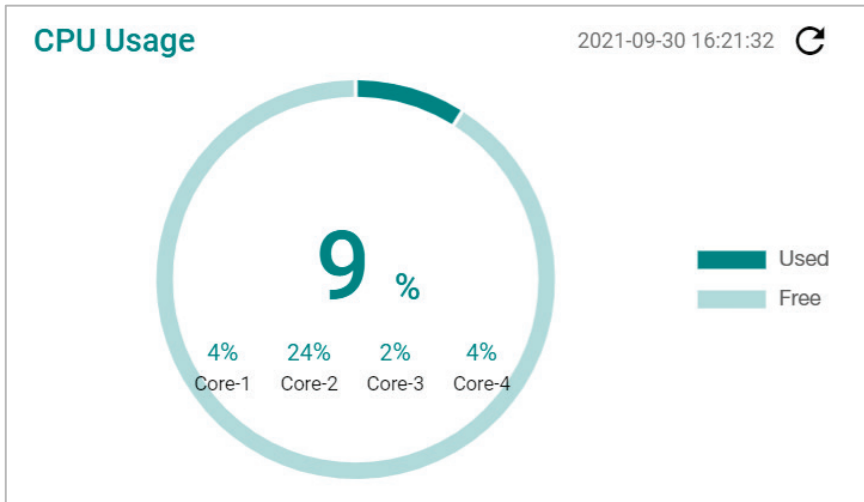

CPU Usage History

The graph shows the CPU usage history.

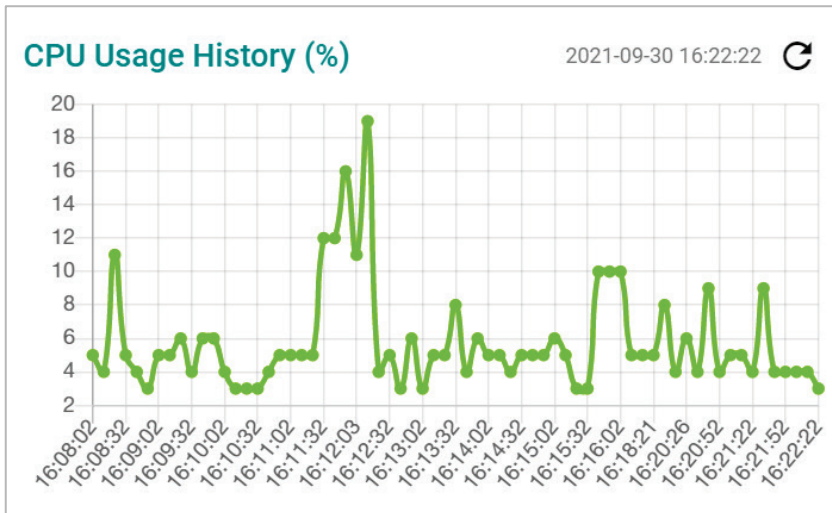

Memory Usage

This widget shows the current memory usage.

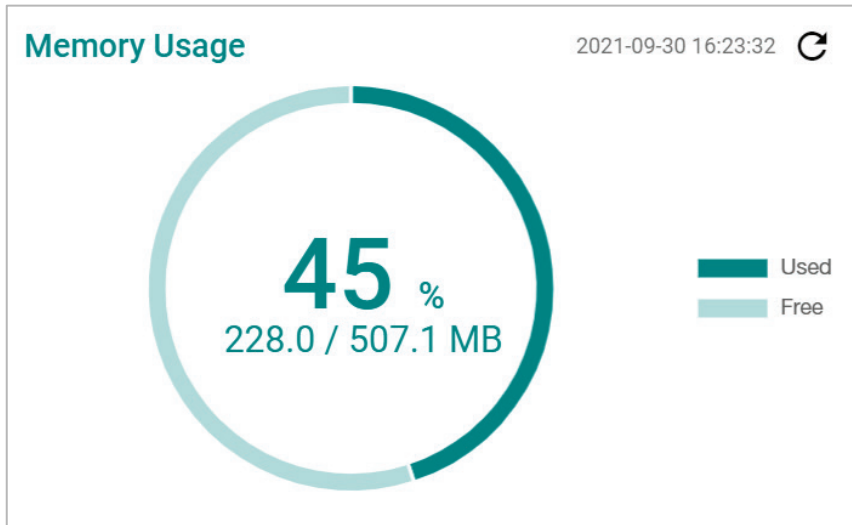

Memory Usage History

This graph shows the memory usage history.

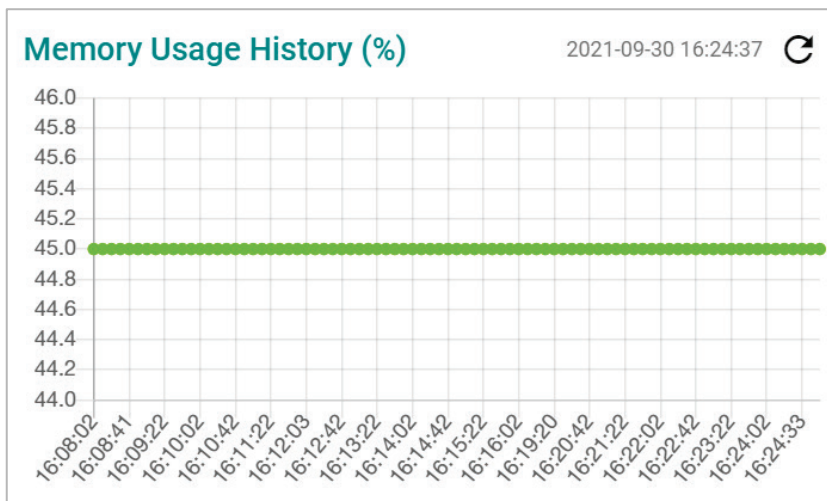

Network Status

The **Network Status** section contains the **Network Statistics**, **LLDP**, **Bridge Table**, and **ARP Table** pages.

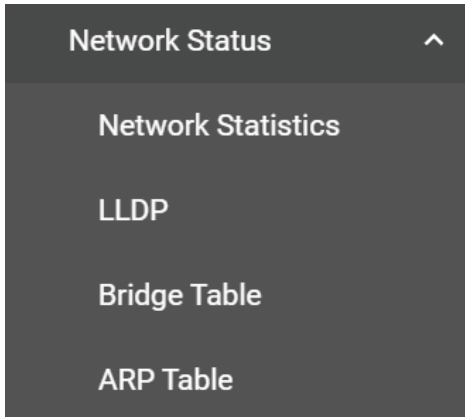

Network Statistics

The **Network Statistics** page shows real-time data for all interfaces. Click **Network Statistics** under **Diagnostics > Network Status** in the function tree to access this page.

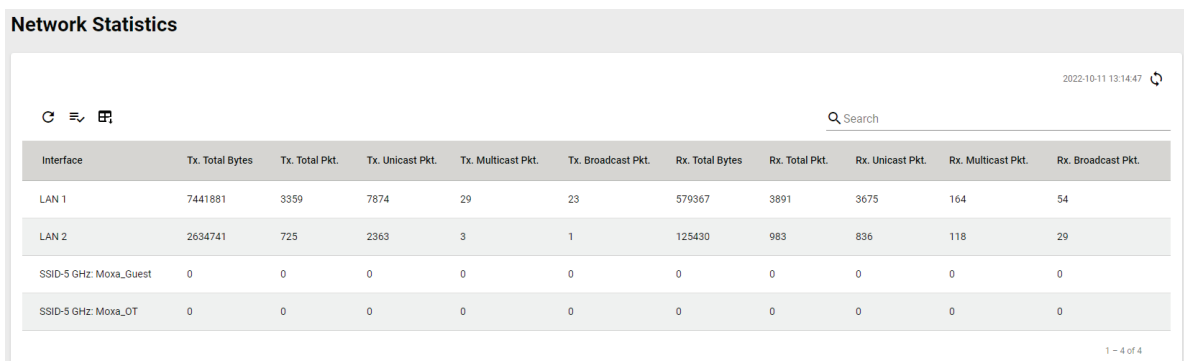
A screenshot of the "Network Statistics" page. It features a table with 11 columns: Interface, Tx. Total Bytes, Tx. Total Pkt., Tx. Unicast Pkt., Tx. Multicast Pkt., Tx. Broadcast Pkt., Rx. Total Bytes, Rx. Total Pkt., Rx. Unicast Pkt., Rx. Multicast Pkt., and Rx. Broadcast Pkt. The table lists four interfaces: LAN 1, LAN 2, SSID-5 GHz: Moxa_Guest, and SSID-5 GHz: Moxa_OT. The page also includes a search bar and a refresh icon in the top right corner.

Interface	Tx. Total Bytes	Tx. Total Pkt.	Tx. Unicast Pkt.	Tx. Multicast Pkt.	Tx. Broadcast Pkt.	Rx. Total Bytes	Rx. Total Pkt.	Rx. Unicast Pkt.	Rx. Multicast Pkt.	Rx. Broadcast Pkt.
LAN 1	7441881	3359	7874	29	23	579367	3891	3675	164	54
LAN 2	2634741	725	2363	3	1	125430	983	836	118	29
SSID-5 GHz: Moxa_Guest	0	0	0	0	0	0	0	0	0	0
SSID-5 GHz: Moxa_OT	0	0	0	0	0	0	0	0	0	0

LLDP

LLDP is an OSI Layer 2 protocol defined by IEEE 802.11AB. LLDP standardizes the self-identification advertisement method, and allows each networking device, such as a Moxa managed switch or access point, to periodically send its system and configuration information to its neighbors. Because of this, all LLDP devices are kept informed of each other's status and configurations. With SNMP, this information can be used to generate network visualization.

From the web interface, you can enable or disable LLDP, and set the LLDP transmit interval. In addition, you can view the neighbor-list, which is reported by its network neighbors.

LLDP Settings

Click the **Settings** tab to enable or disable LLDP and set the transmission interval.

LLDP

Settings Status

LLDP Status *
Enabled

Transmission Interval
30
5 - 4095 sec.

APPLY

Configure the following settings:

LLDP Status

Setting	Description	Factory Default
Enabled/Disabled	Enable or disable LLDP.	Enabled

Transmission Interval

Setting	Description	Factory Default
5 to 4095 (sec.)	Specify the transmission interval at which LLDP messages are sent.	30



NOTE

The LLDP protocol transmits data in clear text and discloses the device model name.

When finished, click **APPLY**.

LLDP Status

Click the **Status** tab to view the LLDP status.

LLDP

Settings Status

Search



Local Port	Nbr. System Name	Nbr. System Description	Nbr. System Capability	Nbr. Chassis ID	Nbr. Management Address	Nbr. Port ID	Nbr. Port Description
LAN 2	--	--	--	9c:eb:e8:b1:2c:27	--	9c:eb:e8:b1:2c:27	--

Items per page: 20 1 - 1 of 1 |< < > >|

Bridge Table

The **Bridge Table** page provides more detailed bridging information. Click **Bridge Table** under **Diagnostics > Network Status** in the function tree to access this screen.

Bridge Table



 

MAC Address	Interface	Aging Timer (sec.)
00:00:02:00:00:00	SSID: .M-Guest	44.55
00:02:E7:06:EE:27	SSID: .M-Guest	11.45
00:02:E7:09:7B:4A	SSID: .M-Guest	18.78
00:90:E8:A7:79:8E	Local	0.00
9C:EB:E8:B1:2C:27	LAN 2	0.04

ARP Table

The **ARP Table** page shows all ARP entries. Click **ARP Table** under **Diagnostics > Network Status** in the function tree to access this screen.

ARP Table

 

IP Address	MAC Address
192.168.0.40	02:11:32:2B:C2:05
192.168.0.10	D8:BB:C1:08:6B:BD
192.168.0.1	00:11:32:88:1D:17

Max 1024

Event Logs and Notifications

The **Event Logs and Notifications** section is used to configure event and notification settings and includes the **Event Log**, **Notifications**, **Syslog**, **SNMP Trap/Inform**, **Email Settings**, and **Relay Alarm Cut-off** pages.

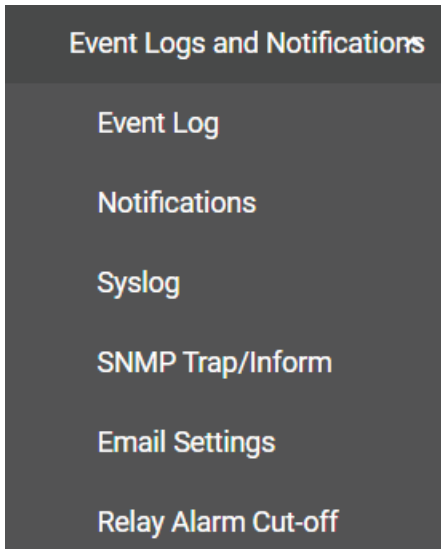



Event Log

From the **Event Log** page, you can view the current log list, configure the log oversize action, and back up the event log. Click **Event Log** under **Diagnostics > Event Logs** and Notifications in the function menu to access this page.

Log List

Click the **Log List** tab to view a list of all logged events.

Event Log						
Log List	Registered Logs	Oversize Action	Backup			
  						<input type="text" value="Search"/>
Index	Bootup Number	Severity	Timestamp	Uptime	Group	Message
1	2	Notice	2022-10-11 13:20:07.397128	0d00h17m52s	System	Configuration saved successfully. (User: admin, IP: 192.168.127.2, Interface: HTTPS)
2	2	Notice	2022-10-11 13:20:07.204867	0d00h17m51s	System	Device configuration was changed. (User: admin, IP: 192.168.127.2, Interface: HTTPS)
3	2	Notice	2022-10-11 13:18:50.952219	0d00h16m35s	Wi-Fi	[M-Guest] Installed key successfully for the AP [7c:57:3c:2e:ba:12].
4	2	Notice	2022-10-11 13:18:50.951461	0d00h16m35s	Wi-Fi	[M-Guest] Successfully connected to AP [7c:57:3c:2e:ba:12].
5	2	Notice	2022-10-11 13:18:50.914628	0d00h16m35s	Wi-Fi	[M-Guest] Successfully associated with AP [7c:57:3c:2e:ba:12].

Registered Logs

Click the **Registered Logs** tab to view and edit event log groups.

Event Log

Log List
Registered Logs
Oversize Action
Backup

	Group Name	Status	Action
	Wi-Fi	Enabled	Local, Syslog
	Network	Enabled	Local, Syslog
	System	Enabled	Local, Syslog
	Account	Enabled	Local, Syslog
	Configuration	Enabled	Local, Syslog
	Power	Enabled	Local, Syslog

To edit an event log group, click the **Edit** icon next to the group you want to edit.

Edit Event Log Registration

Group Name
Wi-Fi

Log Registration Status *
Enabled ▼

Action *
Local, Syslog ▼

CANCEL
APPLY

Configure the following settings:

Log Registration Status

Setting	Description	Factory Default
Enabled/Disabled	Enable or disable the log group. If disabled, events associated with this group will not be logged.	Enabled

Action

Setting	Description	Factory Default
Local	Save the event logs locally.	Local, Syslog
Syslog	Send the event logs to a Syslog server.	

When finished, click **APPLY**.

Oversize Action

From the **Oversize Action** page, you can configure what happens when the log capacity has been reached. Click the **Oversize Action** tab to access this screen.

Event Log

Log List
Registered Logs
Oversize Action
Backup

Oversize Action

Overwrite the oldest event log ▼

Capacity Warning Status *

Disabled ▼ i

APPLY

Automatically Back Up Event Logs to ABC-02

Auto Backup Status *

Disabled ▼

APPLY

Configure the following settings:

Oversize-Action

Setting	Description	Factory Default
Overwrite the oldest event log	Overwrite the oldest event log.	Overwrite the oldest event log
Stop recording event log	Stop recording new event logs.	

Capacity Warning

Setting	Description	Factory Default
Enabled/Disabled	Enable or disable event log capacity warnings.	Disabled

When finished, click **APPLY**.

Auto Backup Status

Setting	Description	Factory Default
Enabled/Disabled	Enable or disable automatic event log backups to an ABC-02.	Disabled

When finished, click **APPLY**.

Backup

Click **Backup** tab to select the storage location.

The screenshot shows the 'Event Log' configuration page. At the top, there are four tabs: 'Log List', 'Registered Logs', 'Oversize Action', and 'Backup'. The 'Backup' tab is active. Below the tabs, there is a 'Storage Location *' dropdown menu. Below the dropdown menu, there is a 'BACKUP' button.

Storage Location

Setting	Description	Factory Default
Local	Back up the event log to the local storage on the AWK device.	None
TFTP	Back up the event log via TFTP.	
SFTP	Back up the event log via SFTP.	
ABC-02	Back up the event log to an ABC-02 USB tool.	

Server IP Address (for TFTP only)

Setting	Description	Factory Default
IP address	Enter the IP address of the TFTP server.	None

File Name (for TFTP only)

Setting	Description	Factory Default
Input the backup file name	Enter the file name of the event log backup.	None

Server IP Address (for SFTP only)

Setting	Description	Factory Default
IP address	Enter the IP address of the SFTP server.	None

Pathname (for SFTP only)

Setting	Description	Factory Default
Pathname	Specify the file path on the SFTP server for storing the event log backup.	None

Account (for SFTP only)

Setting	Description	Factory Default
Account name	Enter the SFTP server account name.	None

Password (for SFTP only)

Setting	Description	Factory Default
Password	Enter the SFTP server account password.	None







Select Folder (for ABC-02 only)

Setting	Description	Factory Default
Folder	Select the folder on the ABC-02 to store the event log backup in.	None

When finished, click **BACKUP**.

Notifications

You can configure the notification settings for individual event types. Click **Notifications** under **Diagnostics > Event Logs and Notifications** in the function tree to access this screen.

Notifications					
Group	Event Name	Status	Severity	Notification Method	
 System	Cold start	Enabled	Notice	Trap, Email	
 System	Warm start	Enabled	Notice	Trap, Email	
 System	Configuration changed	Enabled	Notice	Trap, Email	
 System	Reaching log capacity	Enabled	Alert	Trap, Email	
 Power	Power 1 turned on	Enabled	Warning	Trap, Email	
 Power	Power 1 turned off	Enabled	Warning	Trap, Email	

To edit the notification settings, click the **Edit**  icon next to the event you want to edit.

Edit Event Notification

Event Name
Cold start

Event Notification Status *
Enabled ▼

Notification Method
Trap, Email ▼

CANCEL
APPLY

Configure the following settings:

Event Notification Status

Setting	Description	Factory Default
Enabled/Disabled	Enable or disable notifications for this event.	Enabled

Notification Method

Setting	Description	Factory Default
Trap	Send notifications through SNMP Trap.	Trap/Email
Email	Send notifications through email.	
Relay	Use a relay for sending notifications. This option is only available for specific event groups.	

When finished, click **APPLY**.

Syslog

You can set up one or more Syslog servers to store event logs. Click **Syslog** under **Diagnostics > Event Logs and Notifications** in the function tree to access this screen.

Configure the following settings:

Syslog Status

Setting	Description	Factory Default
Enabled/Disabled	Enable or disable logging events to a syslog server.	Disabled

Event Reporting Severity

Setting	Description	Factory Default
Emerg.	Specify the syslog severity as Emergency.	Info.
Alert	Specify the syslog severity as Alert.	
Crit.	Specify the syslog severity as Critical.	
Error	Specify the syslog severity as Error.	
Warning	Specify the syslog severity as Warning	
Notice	Specify the syslog severity as Notice.	
Info.	Specify the syslog severity as Information.	

Syslog Server 1 Status

Setting	Description	Factory Default
Enabled/Disabled	Enable or disable the first syslog server.	Disabled

Syslog Server 2 Status

Setting	Description	Factory Default
Enabled/Disabled	Enable or disable the second syslog server.	Disabled

Syslog Server 3 Status

Setting	Description	Factory Default
Enabled/Disabled	Enable or disable the third syslog server.	Disabled

When finished, click **APPLY**.

SNMP Trap/Inform

The **SNMP Trap/Inform** section is used for setting up SNMP Traps and Inform triggers for events. Click **SNM Trap/Inform** under **Diagnostics > Event Logs and Notifications** in the function tree to access this page.

SNMP Trap/Inform

- General
- SNMP Trap/Inform Account



<input type="checkbox"/>	Recipient IP/Name	Mode	Trap Community

Max 2

SNMP Inform Settings

Inform Retry *
3
1 - 99

Inform Timeout *
10
1 - 300 sec.

APPLY

General Settings

From the **General** tab, you can manage SNMP Trap/Inform recipients. Click the **General** tab to access this screen. Click the **Add**  icon to create a new entry.

Create SNMP Trap/Inform Recipient

Recipient IP/Name *
0 / 60

Mode *
Disabled

CANCEL APPLY

Configure the following settings:

Recipient IP/Name

Setting	Description	Factory Default
0 to 60 characters or IP address	Enter the name or IP of the recipient.	None

Mode

Setting	Description	Factory Default
Disabled	Disable the SNMP Trap/Inform function.	Disabled
Trap V1	Set the trap version to Trap V1.	
Trap V2c	Set the trap version to Trap v2c.	
Inform V2c	Set the inform version to Inform V2c.	
Trap V3	Set the trap version to Trap V3.	
Inform V3	Set the inform version to Inform V3.	

When finished, click **APPLY**.

SNMP Inform Settings

From the SNMP Inform Settings screen, users can make sure SNMP Inform notice packets are sent and received reliably. Users can specify the number of times the system will try to send an inform notice until receiving confirmation from the SNMP Server. Configure the following settings.

Inform Retry

Setting	Description	Factory Default
1 to 99	Specify the maximum number of Inform retries.	3

Timeout

Setting	Description	Factory Default
1 to 300	Specify the Inform timeout value.	10

When finished, click **APPLY**.

SNMP Trap/Inform Account Settings

From the **SNMP Trap/Inform Account** tab, you can manage SNMP Trap/Inform accounts. Click the **SNMP Trap/Inform Account** tab to access this screen. Click the **Add**  icon to create a new entry.

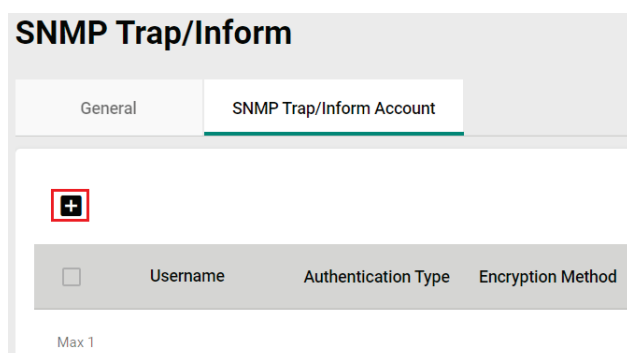

Configure the following settings:

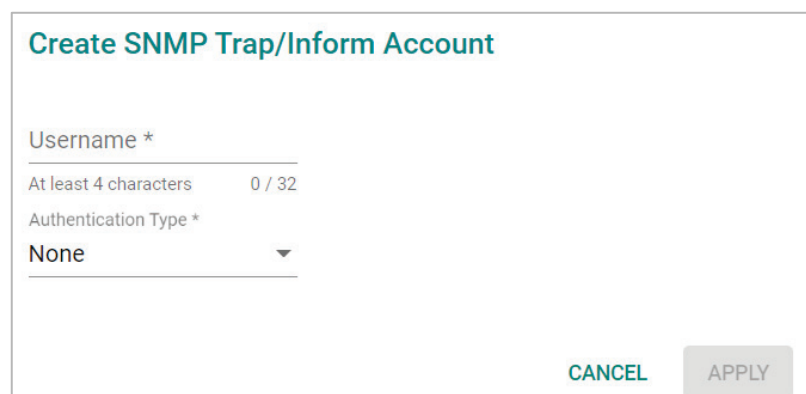

Username

Setting	Description	Factory Default
At least 4 characters, (max. 32 characters)	Enter a username for the account.	None

Authentication type

Setting	Description	Factory Default
None	Do not use any authentication mechanism.	None
MD5	Use MD5 as the authentication type.	
SHA	Use SHA as the authentication type.	

Authentication Password (when the Authentication type is set to MD5 or SHA)

Setting	Description	Factory Default
8 to 64 characters	Enter the authentication password.	None

Encryption Method (when the Authentication type is set to MD5 or SHA)

Setting	Description	Factory Default
None	Do not use any encryption.	None
DES	DES is the encryption method.	
AES	AES is the encryption method.	

Encryption Key (when DES and AES is selected)

Setting	Description	Factory Default
8 to 64 characters	Enter the encryption key.	None

When finished, click **APPLY**.

Email Settings

The **Email Settings** page is used to configure email settings for notifications, including the email server, sender, and recipients. Click **Email Settings** under **Diagnostics > Event Logs and Notifications** in the function tree to access this screen.

Email Settings

Email Server *
_____ 0 / 60

SMTP: TCP Port
25
_____ 0 - 65535

Authentication Status *
Disabled ▾ Username _____ Password * _____ 0 / 60

Security *
None ▾

Sender Email Address
_____ 0 / 60

1st Email Recipient _____ 0 / 60 2nd Email Recipient _____ 0 / 60 3rd Email Recipient _____ 0 / 60

4th Email Recipient _____ 0 / 60 5th Email Recipient _____ 0 / 60

APPLY

Configure the following settings.

Email Server

Setting	Description	Factory Default
IP address or URL	The IP address or URL of the email server.	None

SMTP: TCP Port

Setting	Description	Factory Default
0 to 65535	The TCP port number of the email server.	25

Authentication Status

Setting	Description	Factory Default
Enabled/Disabled	Enable or disable authentication for the email server.	Disabled

Username

Setting	Description	Factory Default
Max. 60 characters	Enter the email user account.	None

Password

Setting	Description	Factory Default
Max. of 60 characters	Enter the email user password	None

Security

Setting	Description	Factory Default
None	Do not use any security method.	None
STARTTLS	Use STARTTLS as the security method.	
SSL/TLS	Use SSL/TLS as the security method.	

Sender Email Address

Setting	Description	Factory Default
Max. 60 characters	Enter the sender's email address.	None

1st to 5th Email Addresses

Setting	Description	Factory Default
Max. 60 characters	Enter the recipient's email address. You can set up to five recipient email addresses to receive alert emails from the AWK device.	None

When finished, click **APPLY**.

Relay Alarm Cut-off

Some events can be triggered by relay. If Relay is set as the notification method in the **Notifications** section, you will see the state for that event is **Triggered** when the corresponding event occurs. Once triggered, you can cut off the relay to deactivate the event. Click **Relay Alarm Cut-off** under **Diagnostics > Event Logs and Notifications** in the function menu to access this screen.



NOTE

Relay Alarm Cut-off is only supported by the AWK-3252A and AWK-4252A Series.

Edit Event Notification

Event Name
LAN 1 enabled

Event Notification Status *
Enabled

Notification Method

- Trap
- Email
- Relay

CANCEL
APPLY

Group	Event Name	Status	State
System	Reaching log capacity	Disabled	---
Power	Power 1 turned off	Disabled	---
Power	Power 2 turned off	Disabled	---
System	DI 1 enabled	Disabled	---
System	DI 1 disabled	Disabled	---
System	DI 2 enabled	Disabled	---
System	DI 2 disabled	Disabled	---
Network	LAN 1 enabled	Enabled	Triggered
Network	LAN 1 disabled	Disabled	---
Network	LAN 2 enabled	Disabled	---
Network	LAN 2 disabled	Disabled	---

Click CUT-OFF to deactivate the event.

System	DI 2 enabled	Disabled	---
System	DI 2 disabled	Disabled	---
Network	LAN 1 enabled	Enabled	None
Network	LAN 1 disabled	Disabled	---
Network	LAN 2 enabled	Disabled	---
Network	LAN 2 disabled	Disabled	---

CUT-OFF

Tools

The Tools sections contains several diagnostics and troubleshooting tools for the AWK, including **Wi-Fi Tools**, **System Data Collection**, **Diagnostic Support**, and **Ping**.

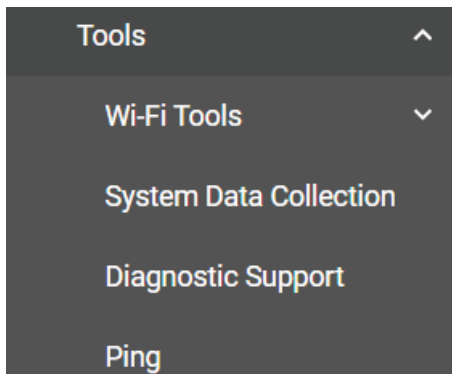

Wi-Fi Tools

Under **Wi-Fi Tools** are the **Channel Scan**, **Wi-Fi Mirroring**, and **RSSI Reporting** functions.

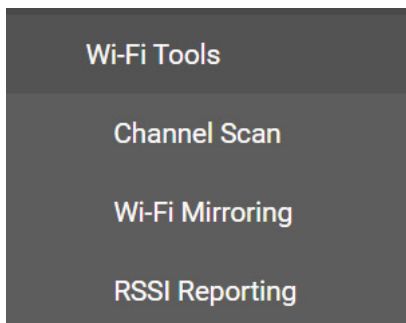

Channel Scan

The Channel Scan function is used to analyze the selected RF band for available channels. Click **Channel Scan** under **Diagnostics > Tools > Wi-Fi Tools** in the function tree to access this screen.

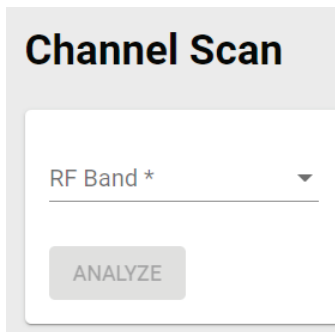

Configure the following setting:

RF Band

Setting	Description	Factory Default
5 GHz	Scan the 5 GHz RF band.	None
2.4 GHz	Scan the 2.4 GHz RF band.	
5 GHz & 2.4 GHz	Scan both 5 GHz and 2.4 GHz RF bands.	

When finished, click **ANALYZE**.

When prompted, click **ANALYZE** again.

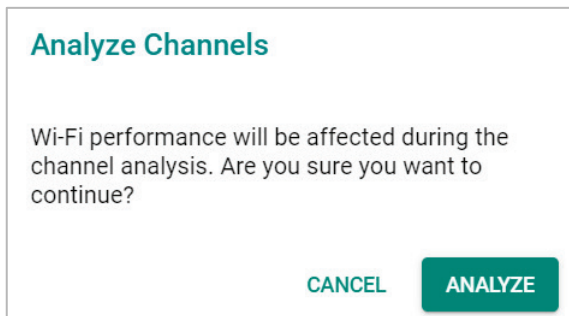

The result of the scan will be shown in the table at the bottom of the page. The Load(%) metric indicates the time the channel was used (in percentage) during the scan. The scan duration is approximately 330 ms for each channel.

Channel Analyze Result: 5GHz

Channel	Number of APs	Load(%)	Noise Floor (dBm)
36 (5180 MHz)	3	2	-106
40 (5200 MHz)	0	1	-106
44 (5220 MHz)	0	1	-105
48 (5240 MHz)	0	1	-106
52 (5260 MHz)	0	1	-106
56 (5280 MHz)	0	0	-106
60 (5300 MHz)	0	0	-107
64 (5320 MHz)	0	0	-107
100 (5500 MHz)	0	1	-108

Wi-Fi Mirroring

Wi-Fi Mirroring lets you copy the traffic of wireless traffic for analysis and troubleshooting purposes. Click **Wi-Fi Mirroring** under **Diagnostics > Tools > Wi-Fi Tools** in the function tree to access this screen.

Wi-Fi Mirroring

Mirroring Type * ▼

Mirroring Period * i
 1 - 60 min.

START STOP

Configure the following settings.

Mirroring Type

Setting	Description	Factory Default
Local	Select Local to mirror traffic to the local storage on the device.	None
Remote	Select Remote to have the AWK act as a server to be used with capturing tool such as Wireshark to capture the mirror traffic.	

Mirroring Period (Local Type only)

Setting	Description	Factory Default
1 to 60 (min.)	Specify how long the device will mirror wireless traffic.	None

When finished, click **START** to start mirroring, and **STOP** to stop mirroring.

The result of the mirroring will be shown below. If you selected Local as the mirroring type, click **DOWNLOAD** to download the result to your local machine.

RSSI Reporting

RSSI Reporting sends out the AP's SNR or detected Signal Strength over Syslog to a designated recipient host for monitoring. This data is used to analyze if the configured Turbo Roaming Threshold and Roaming Difference values are suitable for the current network environment. Click **RSSI Reporting** under **Diagnostics > Tools > Wi-Fi Tools** in the function tree to access this screen.

RSSI Reporting

General Authentication

Status *
Disabled

Recipient

TCP/UDP Port
514 i
0 - 65535

Reporting Interval *
50
50 - 500 ms.

Security *
None

APPLY

Status

Setting	Description	Factory Default
Enabled/Disabled	Enable or disable RSSI Reporting.	Disabled

Recipient

Setting	Description	Factory Default
Host IP/Domain name	Specify the Syslog server host IP or domain name that will receive the RSSI report data.	Empty

TCP/UDP Port

Setting	Description	Factory Default
0 to 65535	Specify the designated Syslog server communication port to receive the RSSI report data on.	None

Reporting Interval

Setting	Description	Factory Default
50 to 500 ms	Specify the interval (in ms) at which RSSI report data is generated and sent to the Syslog server.	None

Security

Setting	Description	Factory Default
None/TLS	Specify whether the generated RSSI report data needs to be TLS encrypted or not.	None

When finished, click **APPLY**.

System Data Collection

The **System Data Collection** section contains the **One Key Information** and **Data Collection** functions.

Download One Key Information

Using the **One Key Info** function, all running configuration files, event logs, and CLI status will be saved as a compressed ZIP file and stored on the selected medium. Click the **One Key Info**. Tab to access this screen.

The screenshot shows the 'System Data Collection' interface with the 'One Key Info.' tab selected. It features a 'File Password *' input field with a strength indicator '1 - 64' and a 'Storage Location *' dropdown menu. A 'DOWNLOAD' button is located below the input fields.

Configure the following settings:

File Password

Setting	Description	Factory Default
1 to 64 characters	Enter the password for the file. This password will be required to open the compressed file.	None

Storage Location

Setting	Description	Factory Default
Local	The file will be downloaded to the local storage on the AWK.	None
TFTP	The file will be downloaded to a TFTP server.	
SFTP	The file will be downloaded to an SFTP server.	
ABC-02	The file will be downloaded to the connected ABC-02 USB.	

Server IP Address (for TFTP only)

Setting	Description	Factory Default
IP address	Enter the IP address of the TFTP server.	None

Server IP Address (for SFTP only)

Setting	Description	Factory Default
IP address	Enter the IP address of the SFTP server.	None

Server Account (for SFTP only)

Setting	Description	Factory Default
Account name	Enter the account name of the SFTP server.	None

Server Password (for SFTP only)

Setting	Description	Factory Default
Account password	Enter the account password of the SFTP server.	None

When finished, click **DOWNLOAD** to download the file.

Data Collection

The **Data Collection** function is used to gather selected system information at specific intervals. Click the **Data Collection** tab to access this screen.

System Data Collection

One Key Info. **Data Collection**

Interval *
1 - 30 sec.

Stop Date *  Stop Time 01:00 AM

Storage Location * 

Select the information to collect*

- Wi-Fi Statistic
- Wi-Fi Connection
- Wi-Fi Tx/Rx
- Network
- Service
- System

START **STOP**

Configure the following settings:

Interval

Setting	Description	Factory Default
1 to 30 (sec.)	Specify the interval at which the AWK will collect information.	None

Stop Date

Setting	Description	Factory Default
Date	Specify the date the device will stop collecting information.	None

Stop Time

Setting	Description	Factory Default
Time	Specify the time the device will stop collecting information.	01:00 AM

Storage Location

Setting	Description	Factory Default
Local	The file will be downloaded to the local storage on the AWK.	None
TFTP	The file will be downloaded to a TFTP server.	
SFTP	The file will be downloaded to an SFTP server.	
ABC-02	The file will be downloaded to the connected ABC-02 USB.	

Server IP Address (for TFTP only)

Setting	Description	Factory Default
IP address	Enter the IP address of the TFTP server.	None

Server IP Address (for SFTP only)

Setting	Description	Factory Default
IP address	Enter the IP address of the SFTP server.	None

Server Account (for SFTP only)

Setting	Description	Factory Default
Account name	Enter the account name of the SFTP server.	None

Server Password (for SFTP only)

Setting	Description	Factory Default
Account password	Enter the account password of the SFTP server.	None

Select the information to collect

Setting	Description	Factory Default
Wi-Fi Statistic	Select the types of information you want to collect.	None
Wi-Fi Connection		
Wi-Fi Tx/Rx		
Network		
Service		
System		

When finished, click **START** to begin collecting information, and **STOP** to end.

Diagnostic Support

This feature allows an authorized user to generate an engineering account for Moxa support staff to access and troubleshoot the AWK Series. Click **Diagnostic Support** under **Diagnostics > Tools** in the function tree to access this screen.

Diagnostic Support

Generate Profile

Duration
10
1 - 180 day(s)

GENERATE

Generated Account Status

Status

Remaining Duration

DEACTIVATE

Duration

Setting	Description	Factory Default
1 to 180 (days)	Specify how long the diagnostics account will be active for.	None

You can check the account status at any time in the bottom section of the screen. Click **DEACTIVATE** to immediately terminate a generated diagnostics account.



NOTE

Only provide generated diagnostics account credentials to authorized Moxa support personnel.

Ping

The **Ping** function is used to check the connection to a remote host. Click **Ping** under **Diagnostics > Tools** in the function tree to access this screen.

Configure the following settings:

Target

Setting	Description	Factory Default
IP address/hostname	Enter the IP address or hostname you want to ping.	None

Ping Interval

Setting	Description	Factory Default
1 to 30 (sec.)	Specify the interval at which the AWK will ping the host.	1

Stop Method

Setting	Description	Factory Default
Rounds	Specify Rounds as the stop method.	Rounds
Timestamps	Specify Timestamps as the stop method.	

Rounds (for Rounds Method only)

Setting	Description	Factory Default
3 to 86400	Specify the round value.	3

End Date (for Timestamps Method only)

Setting	Description	Factory Default
Date	Specify the date when to stop pinging the IP address or hostname.	None

End Time (for Timestamps Method only)

Setting	Description	Factory Default
Time	Specify the time to stop pinging the IP address or hostname.	01:00 AM

When finished, click **PING** to begin pinging, or **STOP** to send.

Setup Wizard

The **Setup Wizard** allows users to perform basic device configurations to get the AWK running quickly.

Click **Setup Wizard** in the function tree to start the Wizard, then follow the on-screen instructions. There are three configuration tabs: **Wi-Fi Basic**, **Wi-Fi Security**, and **System**. While the Wizard will start from the **Wi-Fi Basic** section by default, you can go to any other tab at any time.

Wi-Fi Basic

Configure the following settings:

1 Wi-Fi Basic

Operation Mode *
AP

Environment *
Indoor

SSID: 5 GHz
SSID Status * Enabled | SSID * Moxa_OT | 7 / 32
Channel * 36 (5180 MHz) | Bonded Channel(s) 40, 44, 48

SSID: 2.4 GHz
SSID Status * Enabled | SSID * Moxa_Guest | 10 / 32
Channel * 3 (2422 MHz) | Bonded Channel(s) 7

NEXT

Operation Mode

Setting	Description	Factory Default
Disabled	Disable the operation mode.	Disabled
AP	Specify the operation mode as AP. Refer to AP Mode Settings .	
Master	Specify the operation mode as Master. Refer to Master Mode Settings .	
Mesh	Specify the operation mode as Mesh. Refer to Mesh Mode Settings . (AWK-3252A, AWK-4252A only)	
Client	Specify the operation mode as Client. Refer to Client Mode Settings .	
Client-Router	Specify the operation mode as Client-Router. Refer to Client-Router Mode Settings .	
Slave	Specify the operation mode as Slave. Refer to Slave Mode Settings .	

Environment

Setting	Description	Factory Default
Indoor	Set the application environment to indoor. Available channels vary depending on the selection.	Indoor
Outdoor	Set the application environment to outdoor. Available channels vary depending on the selection.	

SSID: 2.4 GHZ

SSID Status

Setting	Description	Factory Default
Enabled/Disable	Enable or disable the SSID.	Disabled

SSID

Setting	Description	Factory Default
1 to 32 characters	Enter a name for the SSID.	None

Channel (available in AP, Master, and Mesh modes only)

Setting	Description	Factory Default
1 (2412 MHz) to 11 (2462 MHz)	Select the channel from the drop-down list. Each channel supports different frequencies.	6 (2437 MHz)

Bonded Channel (available in AP, Master, and Mesh modes only)

Setting	Description	Factory Default
10 (read only)	The bonded channel used by the AP will be shown here if channel width is set to 20/40 MHz.	None

SSID: 5 GHZ

SSID Status

Setting	Description	Factory Default
Enabled/Disable	Enable or disable the SSID.	Disabled

SSID

Setting	Description	Factory Default
1 to 32 characters	Enter a name for the SSID.	None

RF Band (for Client, Client-Router, and Slave modes only)

Setting	Description	Factory Default
5 GHz	Select 5 GHz as the RF band.	5 GHz
2.4 GHz	Select 2.4 GHz as the RF band.	
5 GHz & 2.4 GHz	Select both 5 GHz and 2.4 GHz as the RF bands.	

5 GHz Channel Plan (for Client, Client-Router, and Slave modes only)

Setting	Description	Factory Default
Channel	Select the channel for the 5 GHz band.	Any

Channel (for AP, Master, and Mesh modes only)

Setting	Description	Factory Default
36 (5180 MHz) to 165 (5825 MHz)	Select the channel from the drop-down list. Each channel supports different frequencies.	36 (5180 MHz)

Bonded Channel (for AP, Master, and Mesh modes only)

Setting	Description	Factory Default
40/44/48 (read only)	The bonded channel used by the AP will be shown here if channel width is set to 36 (5180 GHz).	None

When finished, click **NEXT**.

Wi-Fi Security

AP/Master/Mesh Mode

5 GHz

SSID
Moxa_OT

Security *
WPA2

Protected Management Frame *
Disabled

WPA Mode *
Personal

Encryption *
AES

EAPOL Version *
1

Passphrase *
.....

At least 8 characters 10 / 64

2.4 GHz

The SSID does not have any security enabled. We recommend disabling it.

SSID
Moxa_Guest

Security *
Open

NEXT **BACK**

Client/Client-Router/Slave Mode

SSID
.M-Guest

Security *
WPA2

Protected Management Frame *
Disabled

WPA Mode *
Personal

Encryption *
AES

EAPOL Version *
1

Passphrase
.....

At least 8 characters 8 / 64

NEXT **BACK**

SSID

Setting	Description	Factory Default
SSID (read only)	Shows the name for the SSID.	None

Security

Setting	Description	Factory Default
Open	Disable security on the SSID. This is not recommended.	Open
WPA	Use WPA authentication.	
WPA2	Use WPA2 authentication. This mode supports IEEE 802.11i with TKIP/AES + 802.1X encryption.	

Setting	Description	Factory Default
WPA3	Use WPA3 authentication. This mode supports SAE (Simultaneous Authentication of Equals) to avoid network attacks, such as KRACK.	
WPA/WPA2 Mixed	Use WPA/WPA2 Mixed authentication. This allows both WPA and WPA2 clients to connect to the AWK.	
WPA2/WPA3 Mixed	Use WPA/WPA3 Mixed authentication. This allows both WPA2 and WPA3 clients to connect to the AWK.	

When using any security mode except **Open**, configure the following settings:

Protected Management Frame

Setting	Description	Factory Default
Disabled	Disable the protected management frame. This option is not available when using WAP3.	Disabled
802.11w	Use 802.11w protocol as the protected management frame.	

WPA type

Setting	Description	Factory Default
Personal	Use WPA, WPA2, and WPA3 with a Pre-shared Key (PSK).	Personal
Enterprise	Use WPA, WPA2, and WPA3 with EAP security.	

Primary/Secondary RADIUS Server IP (for Enterprise mode only)

Setting	Description	Factory Default
IP address	Specify the RADIUS authentication server for EAP.	None

Primary/Secondary RADIUS Port (for Enterprise mode only)

Setting	Description	Factory Default
0 to 65535	Specify RADIUS server port number.	1812

Primary/ Secondary RADIUS Shared Key (for Enterprise mode only)

Setting	Description	Factory Default
0 to 128 characters	Enter the secret key shared for communication between AP and the RADIUS server. The key cannot contain the following special characters: ` ' " ; & \$	None

Encryption

Setting	Description	Factory Default
AES	Use Advance Encryption System (AES) encryption.	TKIP/AES Mixed
TKIP/AES Mixed*	Use TKIP/AES Mixed encryption. This option provides a TKIP broadcast key and TKIP+AES unicast key to support legacy AP clients. This option is rarely used and is not available when using WAP3.	

*This option is available for legacy mode in AP/Master only and does not support AES-enabled clients.

EAPOL Version

Setting	Description	Factory Default
1	Use EAPOL Version 1 as the security authentication method.	1
2	Use EAPOL Version 2 as the security authentication method.	

Passphrase (for Personal mode only)

Setting	Description	Factory Default
8 to 63 characters	Enter the passphrase. This is the master key to generate keys for encryption and decryption. The passphrase cannot contain the following special characters: ` ' " ; & \$ Check Show Password to display the password in clear text.	None

EAP Protocol (for Enterprise mode only)

Setting	Description	Factory Default
TLS	Use EAP-TLS to validate the connection. This option allows the user to upload a TLS certificate to perform the identity check.	TLS
TTLS	Use TTLS to validate the connection. This option requires users to also specify the Anonymous Name, Username, and Password.	
PEAP	Use PEAP to validate the connection. This option requires users to also specify the Anonymous Name, Username, and Password.	

When finished, click **NEXT**.

System

Device Name *
moxa-awk-3252a
a-z, 0-9, and dash only 14 / 256

Time

Clock Source *
Sync From Browser ▼

Time Zone *
UTC+00:00 ▼

Daylight Saving Status *
Disabled ▼

IP Configuration

IP Mode *
Static ▼

IP Address * 192.168.0.222 Subnet Mask * 24 (255.255.255.0) ▼ Default Gateway _____

DNS Server 1 _____ DNS Server 2 _____

APPLY **BACK**

Device Name

Setting	Description	Factory Default
1 to 255 characters	Enter a name for the device. This is useful for differentiating between the roles or applications of different units. Note that the device name cannot be empty and must comply with the following naming rules: <ul style="list-style-type: none">• Only supports letters (a-z), numbers (0-9), and special character dash (-)• Cannot contain any spaces• Cannot start with dash (-)• Cannot end with dash (-)• When used in a PROFINET environment, cannot start with the prefix "port-x" where "x" equals 0 to 9. There is no validity check to identify incorrect name formats.	Moxa-awk-3252a

Time

Clock Source

Setting	Description	Factory Default
Sync From Browser	Synchronize the system clock with the browser's clock.	Sync From Browser
NTP	Set the clock source to NTP. This will sync the system clock with an external NTP server.	

Time Server 1 (for Clock Source is NTP)

Setting	Description	Factory Default
NTP time server	Specify the IP or domain address of the primary NTP server to use (e.g., 192.168.1.1, time.stdtime.gov.tw, or time.nist.gov).	None

Time Server 2 (for Clock Source is NTP)

Setting	Description	Factory Default
NTP time server	Specify the IP or domain address of the secondary NTP server. The secondary NTP server acts as a backup in case the device fails to connect to the first NTP server.	None

Time Zone

Setting	Description	Factory Default
Time zone	Select a time zone.	UTC+00:00

Daylight Saving Time Status

Setting	Description	Factory Default
Enabled/Disabled	Enable or disable Daylight Saving Time.	Disabled

Offset

Setting	Description	Factory Default
User-specified value	Specify the offset value for Daylight Saving Time.	00:00

Start

Setting	Description	Factory Default
User-specified date	Specify the date that Daylight Saving Time begins.	None

End

Setting	Description	Factory Default
User-specified date	Specify the date that Daylight Saving Time ends.	None

IP Configuration

IP Mode

Setting	Description	Factory Default
DHCP	The AWK is assigned an IP address automatically by the network's DHCP server.	Static
Static	Manually configure up the AWK's IP address.	

IP Address (for Static mode only)

Setting	Description	Factory Default
IP address	Enter the AWK's IP address.	192.168.127.253

Subnet Mask (for Static mode only)

Setting	Description	Factory Default
Subnet mask	Select the subnet mask. This is used to identify the type of network the AWK is connected to (e.g., 255.255.0.0 for a Class B network, or 255.255.255.0 for a Class C network).	24 (255.255.255.0)

Default Gateway (for Static mode only)

Setting	Description	Factory Default
IP address	Enter the IP address of the router that connects the LAN to an outside network.	None

DNS Server 1 and DNS Server 2 (for Static mode only)

Setting	Description	Factory Default
IP address	Enter the primary and secondary DNS server address. After entering the DNS server's IP address, you can input the AWK's URL (e.g., http://ap11.abc.com) in your browser's address field instead of entering the IP address. The Secondary DNS server will be used if the Primary DNS server fails to connect.	None

When finished, click **APPLY**.

Maintenance and Tools

The user tools and functions are located at the top-right of the interface. Click the three-dot icon in the upper right corner of the page to open the user menu.

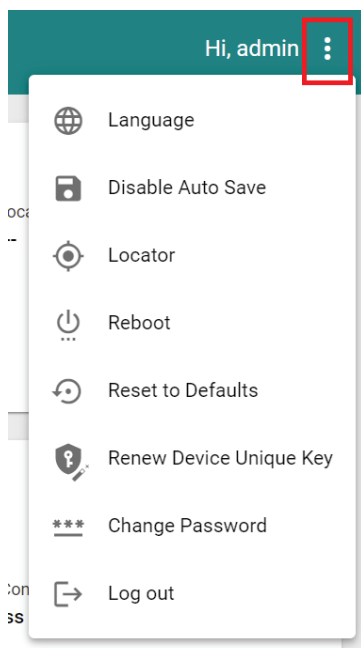

Language

The AWK Series v2.0 firmware and above support language localization. Administrators can select the display language of the web interface from the drop-down menu. The AWK supports the following languages: English, Simplified Chinese, Traditional Chinese, and Japanese. The default is English.

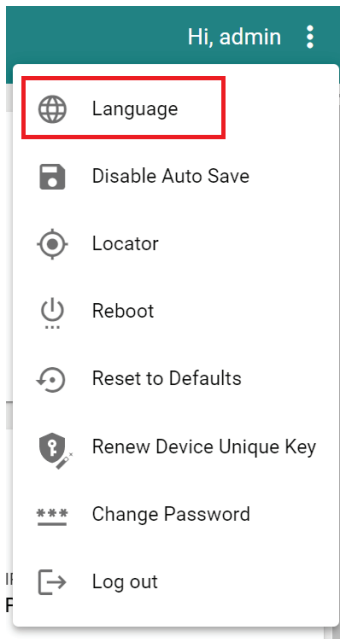

NOTE

Language options are only available for the web interface. The CLI only supports English.

Disable Auto Save

Auto Save will automatically save the configuration changes to the startup configuration. All parameters will be effective immediately when applied, even if the AWK is restarted. If **Auto Save** is disabled, all parameters will be temporarily stored in the running configuration (memory). To make any changes take effect, you will need to save the running-configuration to the startup configuration after applying the changes.

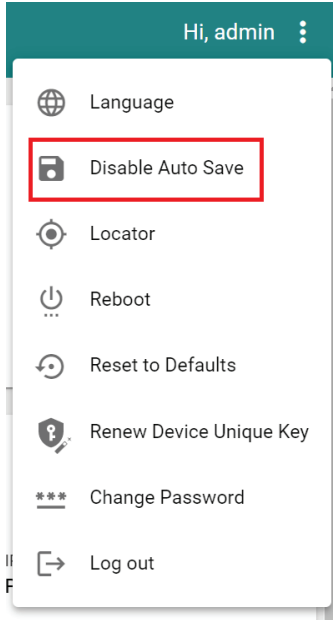

When **Disable Auto Save** is active, only the running configuration is saved. Disconnecting the power or performing a warm start will undo any running changes. When **Auto Save** is enabled, the startup configurations will be saved on the AWK.

To disable the **Auto Save** function, click **Disable Auto Save** in the menu. When prompted, click **DISABLE** to disable the function.

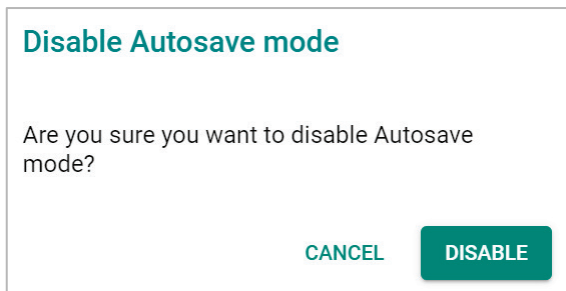

Locator

Clicking **Locator** will trigger the wireless and SYSTEM LEDs to start flashing green at a 4 Hz interval for one minute (default) alongside an audible beeper. This feature is useful for locating the physical device in a field site.

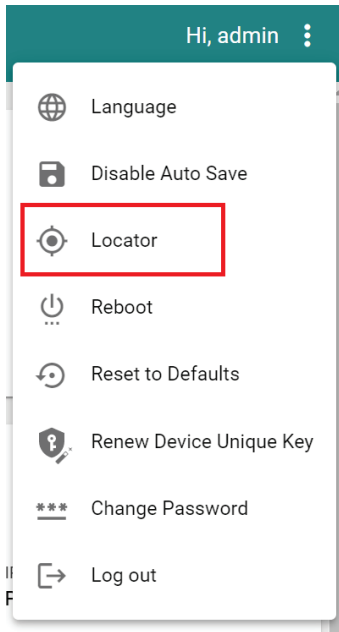
A screenshot of the "Locator" configuration dialog box. It has a title "Locator" and two main settings: "Stop Method *" set to "Timer" and "Stop After *" set to "60". Below the "Stop After *" field, it says "1 - 3600 sec.". At the bottom right, there are two buttons: "CANCEL" and "START".

Stop Mechanism

Setting	Description	Factory Default
Timer	Use a timer to stop the locator LEDs from blinking.	Timer
Manually	Stop the locator LEDs manually.	

Duration

Setting	Description	Factory Default
1 to 3600 (sec.)	Specify the duration the LEDs will be blinking for.	60

When finished, click **START** to activate the LEDs.

LEDs triggered:

AWK-3252A/AWK-4252A: 2.4GHz, 5GHz, SYSTEM (SYS)

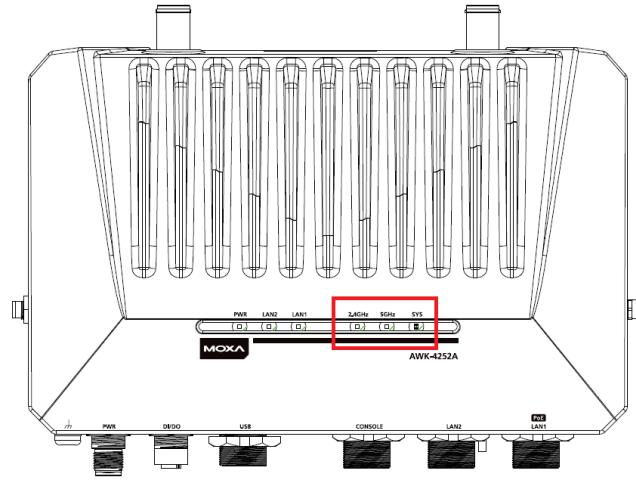
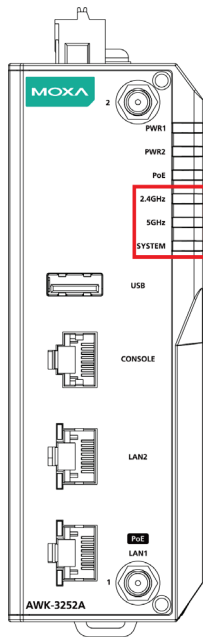

AWK-1151C: WLAN, SYSTEM

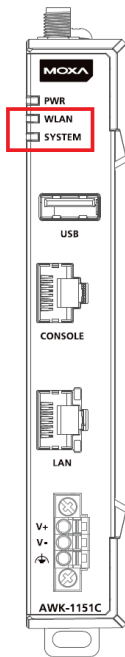

Reboot

To reboot the AWK, click Reboot.

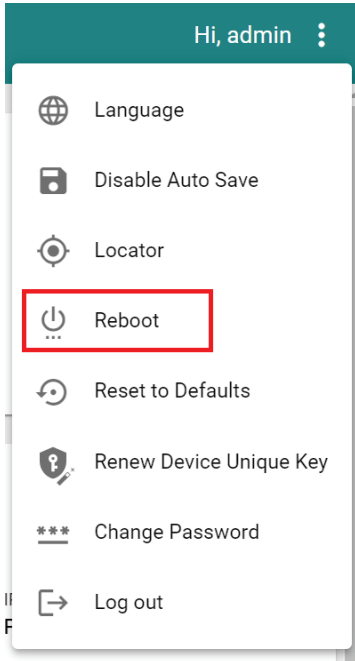

When prompted, click **REBOOT** to reboot the AWK.

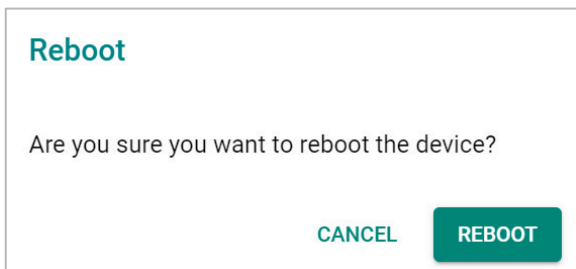

Reset to Defaults

To reset the AWK to the factory default settings, click **Reset to Defaults**.

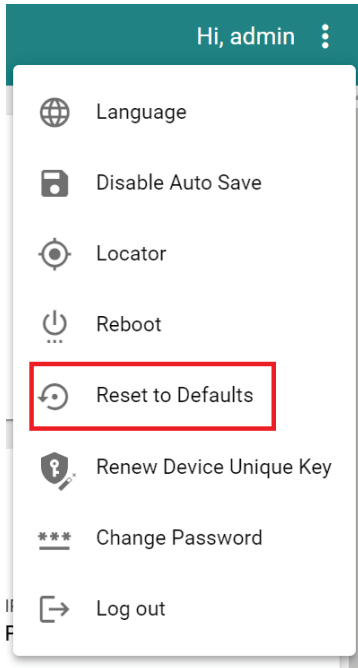

When prompted, check **Keep all event logs** if you want to keep the event history, then click **CONFIRM**.

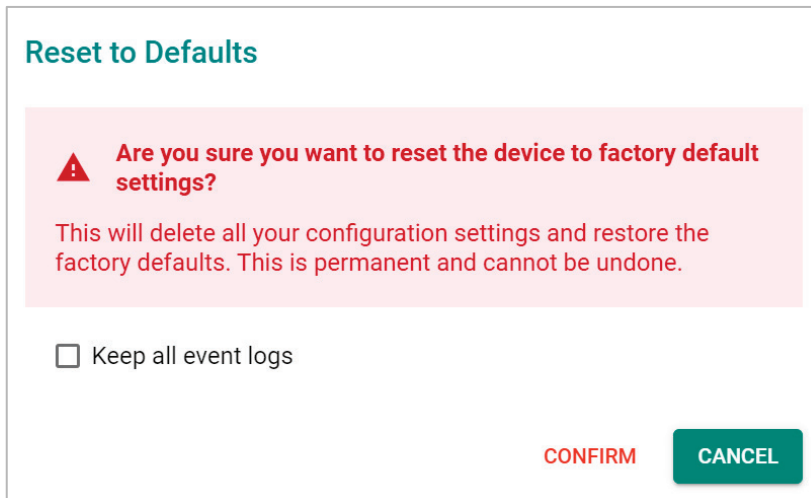

WARNING

Resetting the AWK to the factory default settings will permanently delete all your configuration settings. This is permanent and cannot be undone.

Renew Device Unique Key

The AWK Series has a built-in device unique key. This unique key is used to encrypt the following sensitive information stored on the device:

- Configurations
- Certifications
- Encryption/decryption keys (for firmware decryption, diagnostic support encryption, etc.)

To improve device security, administrators can renew the device unique key from the maintenance list.

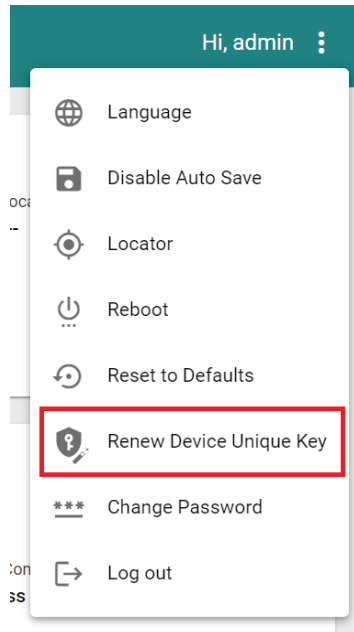

WARNING

When triggered, the system will take 12 to 15 seconds to renew the device unique key and will then reboot to activate the renewed device unique key. Please do not power off the device during this process.

Change Password

Click **Change Password** to change the password of the AWK.

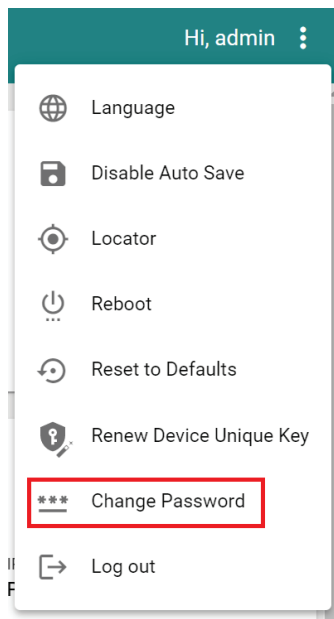

Configure the following settings:

Change Password

Current Password * 
At least 4 characters 0 / 63

New Password * 
At least 4 characters 0 / 63

Confirm Password * 
At least 4 characters 0 / 63

[CANCEL](#) [APPLY](#)

Current Password

Setting	Description	Factory Default
4 to 63 characters	Enter the current password.	None

New Password

Setting	Description	Factory Default
4 to 63 characters	Enter the new password.	None

Confirm Password

Setting	Description	Factory Default
4 to 63 characters	Enter the new password again.	None

When finished, click **APPLY** to change the password.

Log Out

To log out of the AWK, click **Log out**.

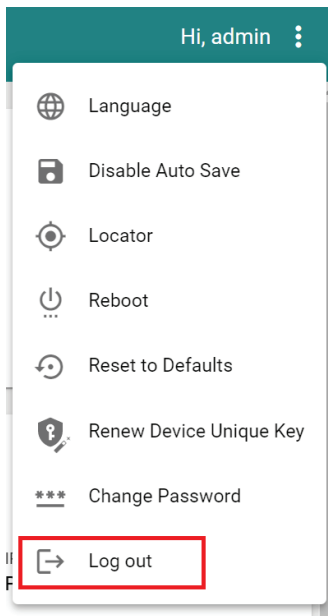

When prompted, click **LOG OUT** to log out of the AWK.

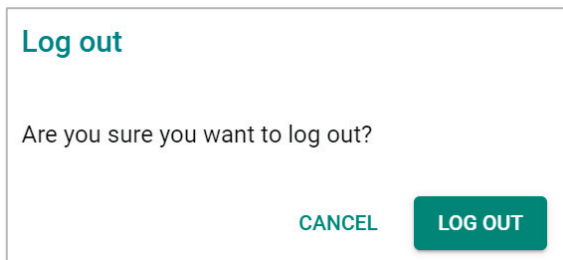

A. Supporting Information

This chapter presents additional information about this product. You can also learn how to contact Moxa for technical support.

Device Recovery

In event the device is not working properly, including configuration changes not applying, the first troubleshooting action is to perform a power cycle. This is done by removing and reconnecting the power and verifying if the situation is resolved.

If power cycle does not solve the issue, the next step is to perform a reset to factory default setting. Refer to **Reset to Defaults**.

If you cannot access the web interface, and/or the Reset button is disabled, you can attempt to reset the device via the serial console's CLI FailSafe mode.



NOTE

The admin password is required to authorize the FailSafe function.

Follow the instructions in the **Accessing the Serial Consoles** section to access the serial console CLI interface and enter the "reload" command to reboot the device.

When the terminal is showing "Restarting device ... [device]# Booting ...", enter the "failsafe" command.

```
COM1,115200,None,8,1,VT100
Profile Edit Port Manager Window Help
Welcome [admin]
The latest successful login time via CLI was: 2021-12-03 11:32:29+00:00
moxa-awk-3252a# reload
Are you sure you want to reboot the device? [y/N]
y
Restarting device ...
moxa-awk-3252a# Booting ...
Not secure ...
failsafe
password:
```

FailSafe mode will be triggered, and you will be prompted to confirm if you want to reset the device back to factory default settings.

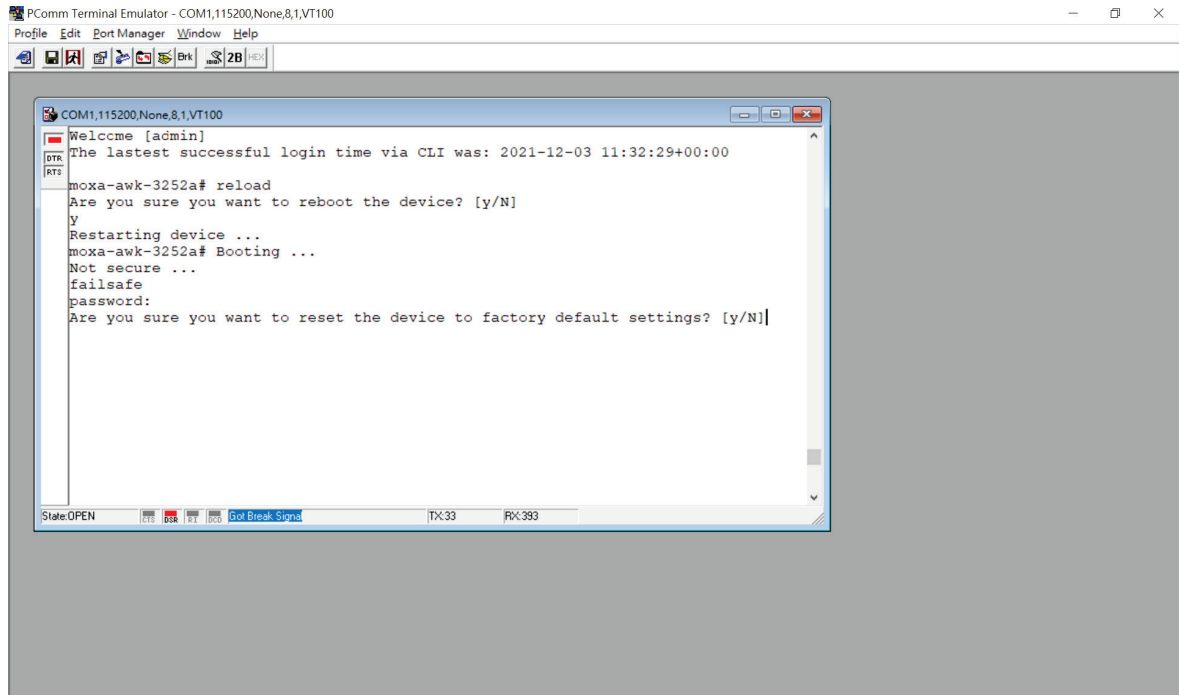

```
PCComm Terminal Emulator - COM1,115200,None,8,1,VT100
Profile Edit Port Manager Window Help
COM1,115200,None,8,1,VT100
Welcome [admin]
The latest successful login time via CLI was: 2021-12-03 11:32:29+00:00
moxa-awk-3252a# reload
Are you sure you want to reboot the device? [y/N]
y
Restarting device ...
moxa-awk-3252a# Booting ...
Not secure ...
failsafe
password:
Are you sure you want to reset the device to factory default settings? [y/N]
```

Enter **Y** to make the device initiate a reset to factory default settings.

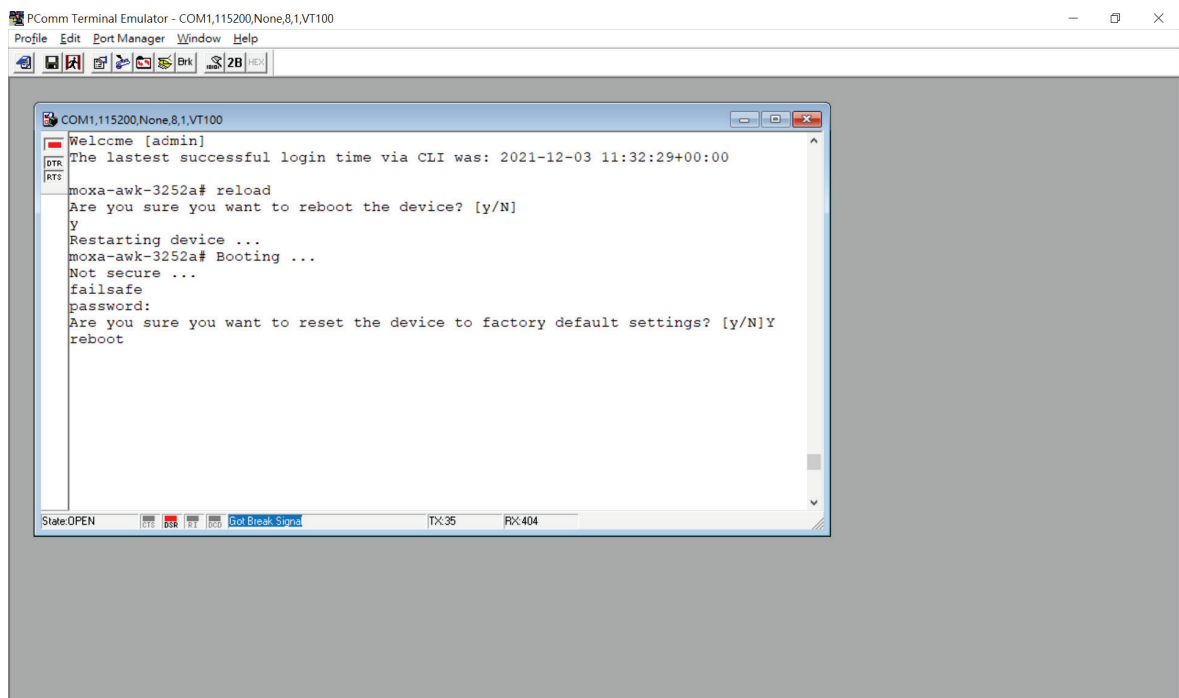

```
PCComm Terminal Emulator - COM1,115200,None,8,1,VT100
Profile Edit Port Manager Window Help
COM1,115200,None,8,1,VT100
Welcome [admin]
The latest successful login time via CLI was: 2021-12-03 11:32:29+00:00
moxa-awk-3252a# reload
Are you sure you want to reboot the device? [y/N]
y
Restarting device ...
moxa-awk-3252a# Booting ...
Not secure ...
failsafe
password:
Are you sure you want to reset the device to factory default settings? [y/N]Y
reboot
```

When the command line prompt displays the login prompt, it means the device was successfully reset to factory default settings.

B. Accessing the Serial Consoles

This chapter explains how to access the AWK Series. In addition to HTTP/HTTPS access, the AWK Series can also be accessed through the serial console and Telnet/SSH console. The serial console connection method, which requires a serial cable to connect the AWK Series to a PC's COM port, can be used if you do not know the AWK Series' IP address. The other consoles can be used to access the AWK Series over an Ethernet LAN, or over the Internet.

RS-232 Console Configuration (115200, None, 8, 1, VT100)

The serial console connection method, which requires a serial cable to connect the AWK Series to a PC's COM port, can be used if you do not know the AWK Series' IP address. It is also convenient to use serial console configurations when you cannot access the AWK Series over Ethernet LAN.



ATTENTION

Do not use the RS-232 console manager when the AWK Series is powered at reversed voltage (ex. -48 VDC), even though reverse voltage protection is supported.

If you need to connect the RS-232 console at reversed voltage, we highly recommend using an isolator, such as the Moxa TCC-82 isolator.



NOTE

We recommend using **Moxa PComm (Lite)** Terminal Emulator, which can be downloaded free of charge from Moxa's website.

Before running PComm Terminal Emulator, use an RJ45-to-DB9-F (or RJ45-to-DB25-F) cable to connect the AWK Series' RS-232 console port to your PC's COM port (generally COM1 or COM2, depending on how your system is set up). After installing PComm Terminal Emulator, perform the following steps to access the RS-232 console utility.

1. From Windows desktop, open the Start menu and run **PComm Terminal Emulator** in the PComm (Lite) group.
2. Select **Open** under **Port Manager** to open a new connection.

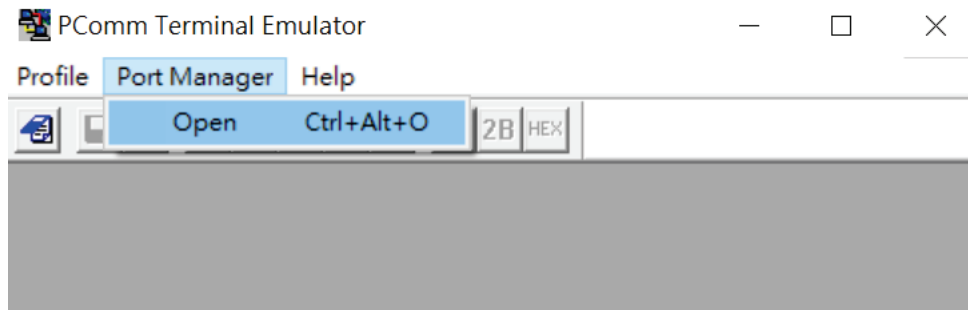

The **Communication Parameter** page of the Property window opens. Select the appropriate COM port for the Console Connection, **115200** for Baud Rate, **8** for Data Bits, **None** for Parity, and **1** for Stop Bits. Click on the **Terminal** tab and select **VT100 (or ANSI)** for Terminal Type. Click **OK** to continue.

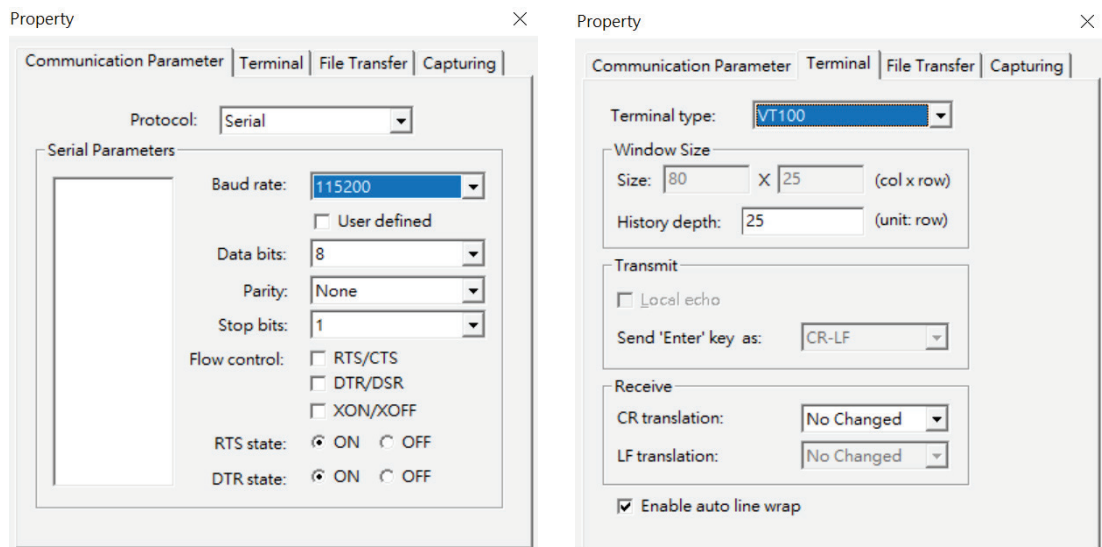

3. The Console login screen will appear. Log into the RS-232 console with the device's account and password.

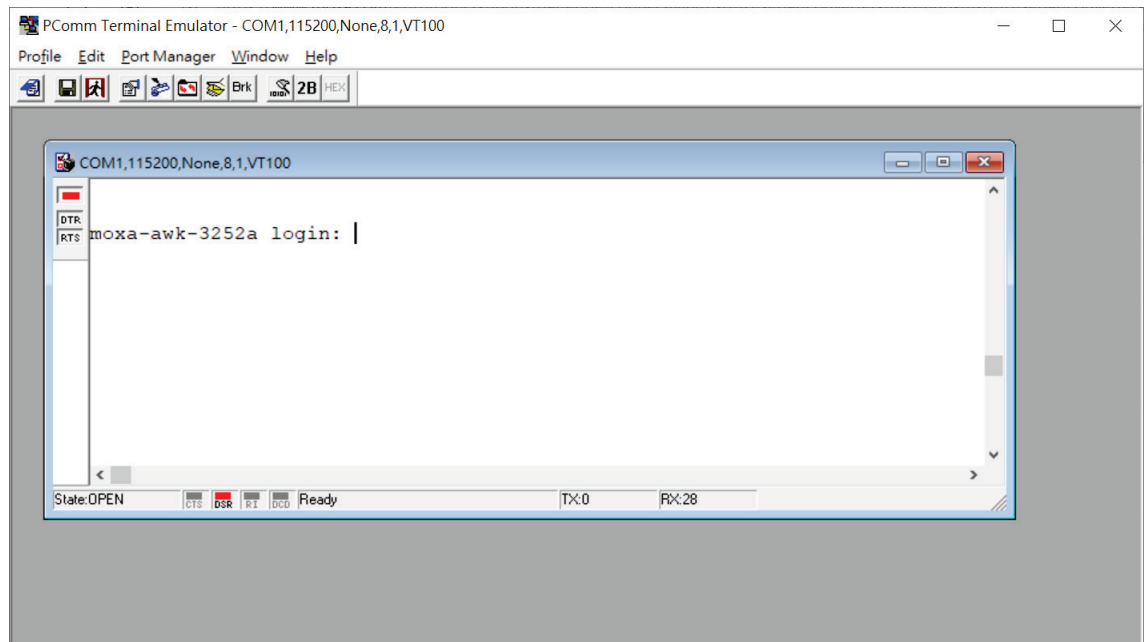

- The AWK Series device's CLI interface will be displayed. Refer to the device's CLI User's Manual for more information and instructions on how to use the command line interface.

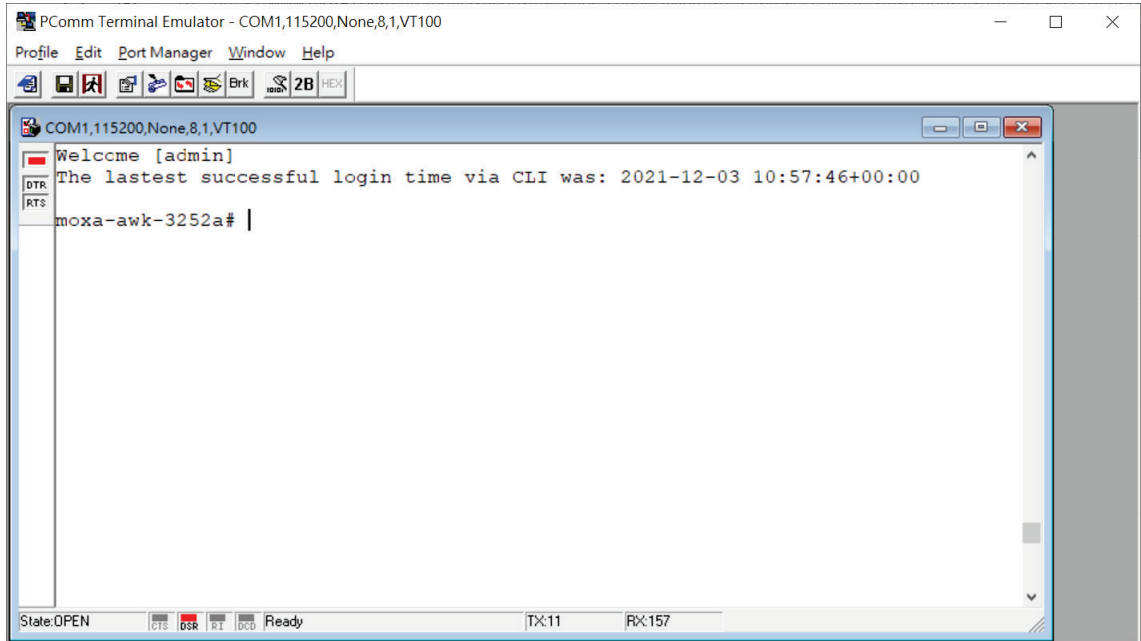

NOTE

To modify the appearance of the PComm Terminal Emulator window, select **Edit > Font** and then choose the desired formatting options.



ATTENTION

If you unplug the RS-232 cable or trigger **DTR**, you will be disconnected and logged out for network security reasons. You will need to log in again to resume operations.

Configuration by Telnet and SSH Consoles

You can use a Telnet or SSH client to access the AWK Series and manage the console over a network. To access the AWK Series' functions over the network from a PC host that is connected to the same LAN as the AWK Series, you need to make sure that the PC host and the AWK Series are on the same logical subnet. To do this, check your PC host's IP address and subnet mask.



NOTE

The AWK Series' default IP address is **192.168.127.253** and the default subnet mask is **255.255.255.0** (for a Class C network). To configure the AWK Series remotely over a LAN network, set the PC host's IP address to 192.168.127.xxx and subnet mask to 255.255.255.0.

Follow the steps below to access the console utility via Telnet or SSH client:

1. From Windows Desktop, run **Start > Run**, and type *telnet (AWK IP address)* in the Run window and click **OK**. The AWK's default IP address is 192.168.127.253.

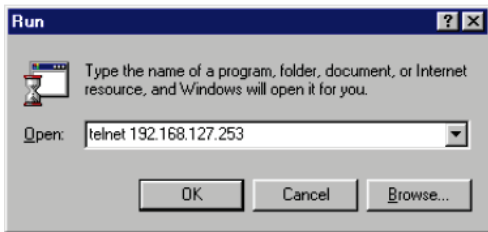

2. When using an SSH client (e.g. PuTTY), run the software and enter the AWK device's IP address as the Host Name along with port **22**, and select **SSH** as the connection type.

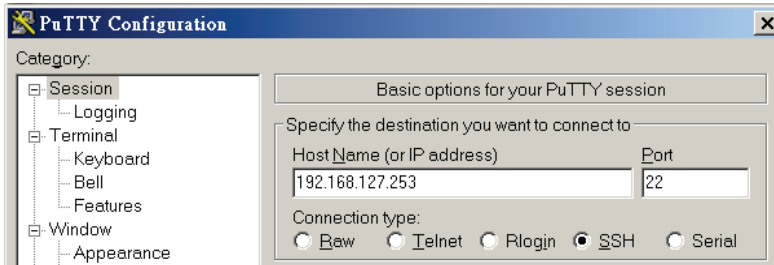

3. The Console login screen will appear. Please refer to the previous paragraph "RS-232 Console Configuration" and for login and administration.

C. Security Guidelines

This appendix provides security practices for installing, operating, maintaining, and decommissioning the device. Moxa strongly recommends that our customers follow these guidelines to enhance network and equipment security.

Installation

Physical Installation

1. To comply with IEC 62443 requirements, the AWK Series device **MUST** be installed within an access-controlled area, where only authorized personnel have physical access to the AWK Series device.
2. To comply with IEC 62443 requirements, the device **MUST NOT** be directly connected to the Internet, which means the AWK Series device **MUST** be installed within a security perimeter with firewall. Additionally, the various application service servers such as DHCP, NTP, RADIUS, ... etc. shall be securely configured with proper authentication within the security perimeter with firewall protection as illustrated in the image below:

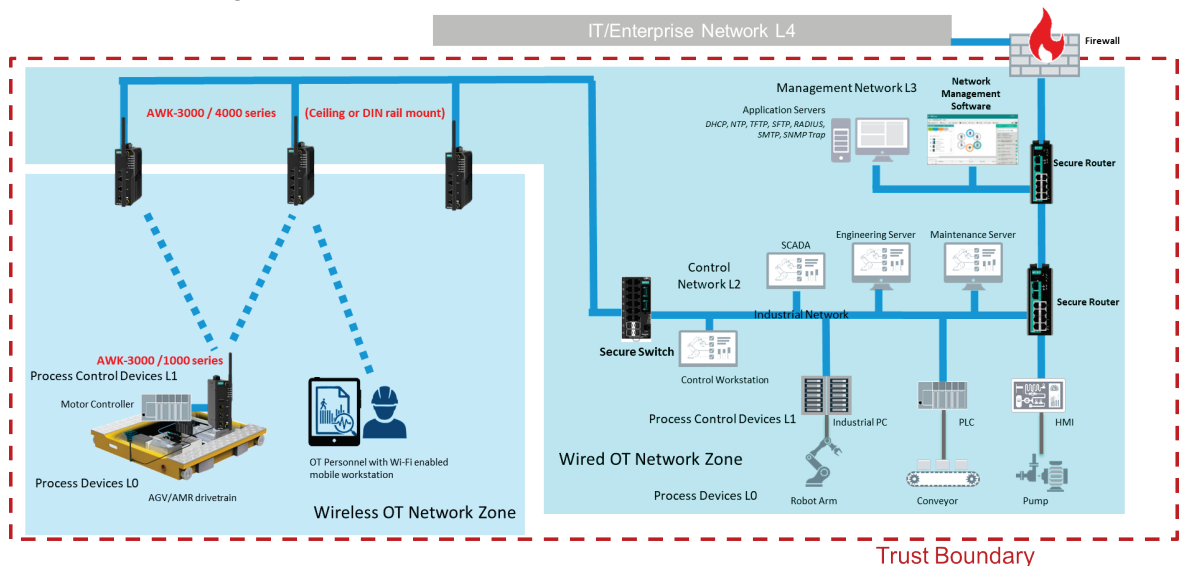

3. Always configure the AWK Series device to comply with your organization's network and security requirements before physical installation. Do not physically install devices that are unconfigured or have an unknown configuration state to avoid unnecessary risks. Please follow the instructions in the Quick Installation Guide, which is included in the package, to ensure you install the device correctly in your environment.
4. The AWK Series has anti-tamper labels visible on the enclosures covering assembly screws. Any tampering to open the mechanical enclosure to access electrical circuit boards will result in the fracturing of anti-tamper labels. This allows an administrator to immediately tell if the device's hardware integrity has been compromised.
5. Ports that are not in use should be deactivated. Please refer to [Hardware Interface](#) and [Ports](#) to review the status of each I/O port and disable any unused ports.
6. The AWK Series devices are industrial WLAN infrastructure components serving as the underlying fabric to support automation processes. These devices are not an integral part of process automation logic and therefore do not support nor are they suitable for any deterministic process control outputs.

Account Management

Follow these best practices when setting up an account:

1. Each account should be assigned the correct privileges: Only allow the minimum number of people to have admin privilege so they can perform device configuration or modifications, while other users should only have the minimum required access privilege needed to fulfill their corresponding role. The AWK Series supports both local account authentication and remote centralized authentication mechanisms such as RADIUS.
2. Password protection has two means of enforcement: Password Lifetime and Password Complexity. We recommend to:
 - a. Review whether the password lifetime needs to be adjusted according to your organization's policies.
 - b. Review whether the configured password complexity options enabled on the AWK Series system (refer to [Create a New Account](#)) is sufficient according to your organization's policies. If not, modify the password complexity requirements to meet your organization's security guidelines.
3. Enforce regulations that ensure only trusted hosts can access the device. Refer to the [Trusted Access](#) section for more information and instructions.

Vulnerable Protocols

1. For network security reasons, we strongly recommend that you change the default port numbers, such as the TCP port number for HTTP, HTTPS, Telnet, and SSH, for protocols that are in use. Ports that are not in use but are still accessible, pose a security risk and should be disabled. Refer to the [Management Interface](#) section for more information and instructions.

Below is the list of default port numbers for each protocol used by all external interfaces.

Browser	Protocol Type	Default Port
TCP	HTTP	80
	HTTPS	443
	Telnet	23
	SSH	22
UDP	SNMP	161
	Moxa Service	40404

2. In order to avoid malicious actors from snooping confidential information, users should always apply encryption-based communication protocols such as HTTPS instead of HTTP, SSH instead of Telnet, SFTP instead of TFTP, SNMPv3 instead of SNMPv1/v2c etc. In addition, the maximum number of sessions should be kept to an absolute minimum. Refer to the [Management Interface](#) section for more information and instructions.
3. Users should generate the SSL certificate for the device before commissioning HTTPS or SSH applications. Please refer to the [Certificate Management](#) section for more information and instructions.
4. The HTTP, SNMPv1v2, and Telnet protocols are insecure and by default DISABLED. We recommend to always use secure alternatives such as HTTPS, SNMPv3, or SSL to protect your communications. If insecure protocols need to be used with legacy devices, please consult a qualified security expert to evaluate and implement additional protection measures to prevent any potential security risks.
5. In order to ensure that the device configurations are adequately protected prior to deployment, it is recommended to review the security status of the device. Refer to the [Security Status](#) section for an overview of the device's current security conditions. If any of the identified risks require mitigating action, navigate to the corresponding setup page to address the issue, or consult a qualified security expert to evaluate and implement additional protection measures to prevent any potential security risks.

Operation

1. The AWK Series supports the TLS v1.3 cryptographic algorithm to protect your HTTPS/SSH applications. Please ensure that your web browser is updated to a version that supports TLS v1.3:

Browser	Version
Microsoft Edge	All versions
Mozilla Firefox	V11 and above
Chrome	V38 and above
Apple Safari	V7 and above for OS X 10,9 (Mavericks) and above

Reference: <https://support.globalsign.com/ssl/general-ssl/tls-protocol-compatibility#Browsers>.

2. The device supports event logs and syslog for SIEM integration:
 - a. Event log: Due to limited storage capacity, the event log can only accommodate a maximum of 10,000 entries. Administrators can set a warning for a pre-defined threshold. We recommend that users regularly back up system event logs. Please refer to the [Event Log](#) section for more information and instructions.
 - b. Syslog: The device supports syslog and advanced secure TLS-based syslog for centralized SIEM integration. Please refer to the [Syslog](#) section for more information and instructions.
3. The device can provide information for control system inventory:
 - a. SNMPv1, v2c, v3: We recommend administrators use SNMPv3 with authentication and encryption to manage the network. Please refer to the MIB file for the detailed OID structure.
 - b. Telnet/SSH: We recommend that administrators use SSH with authentication and encryption to retrieve device properties.
 - c. HTTP/HTTPS: We recommend that administrators use HTTPS with an internally renewed certificate or imported certificate that has been issued by a Certificate Authority (CA) to configure the device.
4. Denial of Service protection: We recommend enabling Trusted Access, Wi-Fi ACL, L2/L3 firewalls to mitigate the risk of DoS attack attempts.
5. Periodically regenerate the SSH and SSL certificates: Even though the device supports up-to-date cipher suites to ensure sufficient complexity, we strongly recommend users to frequently renew their SSH key and SSL certificate in case the key is compromised. Please refer to the [Certificate Management](#) section for more information and instructions.

Maintenance

1. Perform firmware upgrades frequently to enhance features, deploy security patches, or fix bugs. Periodically check the official product website or Moxa security advisory updates at <https://www.moxa.com/en/support/product-support/security-advisory/security-advisories-all>.
2. Periodically, or after each maintenance session, back up the running system configuration to be able to restore the device back to the latest stable, secure state if necessary. The device supports password encryption and signature authentication for backup files to protect the system configuration files from being tampered with,
3. Examine event logs frequently to detect any anomalies.
4. Periodically, or after each maintenance session, check the [Security Status](#) overview to review and confirm the current device's security conditions.
5. To report vulnerabilities of Moxa products, please submit your findings on the following web page: <https://www.moxa.com/en/support/product-support/security-advisory/report-a-vulnerability>.



ATTENTION

For AWK-1151C models: Due to a console port hardware limitation on AWK-1151C models, disconnecting the console cable **WILL NOT** immediately auto-logout an active CLI session but rather auto-logout once the active session times out. To prevent exposure risks on the AWK-1151C's console connections, always log out each CLI session before disconnecting the console cable.

Decommission

1. Power off the device to be decommissioned and unmount it from its physical installation location.
2. Identify the serial number or device name and locate (if applicable) any configuration backup files or certificates generated by the device to be decommissioned and ensure the deletion of these files.
3. To avoid any sensitive information such as the organization's information, account passwords, or certificates from being leaked, always reset the device to the factory default settings before decommissioning the device.

D. Service Authority Table

This appendix lists the required authority for each feature or service. The purpose of this table is to help administrators review and decide the appropriate account privileges and role to assign to user accounts.

Authority	Admin	Engineer	User
Account System	Yes	No	No
Auditor System	Yes	Yes	No
Advanced Diagnostics	Yes	Yes	No
Diagnostics	Yes	Yes	Yes
Network Configuration	Yes	Yes	No
Status Monitoring	Yes	Yes	Yes
System Backup	Yes	No	No
System Management	Yes	Yes	No

Configuration Section	Authority Required
Device Summary	Status Monitoring
System	
System Management	
System Information	System Management
Firmware Upgrade	System Management
Configuration Backup and Restore	System Backup
Account Management	
User Account	(Refer to breakdown below)
Settings	Account System
Session Management	System Management
Password Policy	Account System
Management Interface	
User Interface	System Management
Hardware Interface	System Management
SNMP	(Refer to breakdown below)
SNMP	System Management
SNMP Account List	Account System
Time	
System Time	System Management
Wi-Fi	
Wireless Settings	(Refer to breakdown below)
General	Network
MAC Cloning	Network
Status	Status Monitoring
Connection Management	Network
Roaming	Network
Wi-Fi Security	Network
Ports	
Port Settings	(Refer to breakdown below)
General	Network
Port Status	Status Monitoring
Layer 2 Switching	
VLAN	Network
IP Configuration	
General	System Management
Status	Status Monitoring
Network Service	
DHCP Server	Network

Configuration Section	Authority Required
Routing and Nat	
Routing	
Unicast Route	
Static Route	Network
Routing Table	Status Monitoring
NAT	
Rule List	Network
Firewall	
Layer 2 Policy	Network
Layer 3 Policy	Network
Certificate Management	System Management, Auditor System, System Backup, Status Monitoring, Diagnostics, Advanced Diagnostic, or Network Configuration
Security	
Device Security	
Login Policy	System Management
Trusted Access	System Management
Diagnostics	
Security Status	Status Monitoring
Network Status	
Network Statistics	Status Monitoring
LLDP	(Refer to breakdown below)
Settings	Network
Status	Status Monitoring
Bridge Table	Status Monitoring
ARP Table	Status Monitoring
Event Logs and Notifications	
Event Log	(Refer to breakdown below)
Log List	Status Monitoring
Registered Logs	Auditor System
Oversize Action	Auditor System
Backup	Status Monitoring
Event Notifications	Auditor System
Syslog	Auditor System
General	Auditor System
Authentication	Auditor System
SNMP Trap/Inform	Auditor System
General	Auditor System
SNMP Trap/Inform Account	Auditor System
Email Settings	Auditor System
General	Auditor System
Authentication	Auditor System
Relay Alarm Cut-off	Auditor System
Tools	
Wi-Fi Tools	
Channel Scan	Advanced Diagnostic
Wi-Fi Mirroring	Diagnostic
General	Diagnostic
Authentication	Diagnostic
RSSI Reporting	Diagnostic
System Data Collection	Diagnostic
Diagnostic Support	Advanced Diagnostic
Ping	Diagnostic
Setup Wizard	Network and System Management
Maintenance Bar	
Language	Basic
Disable/Disable Auto Save	System Management
Locator	Diagnostic

Configuration Section	Authority Required
Reboot	System Management
Reset Device	System Management
Renew Device Unique Key	System Management
Change Password	Basic
Log Out	Basic